

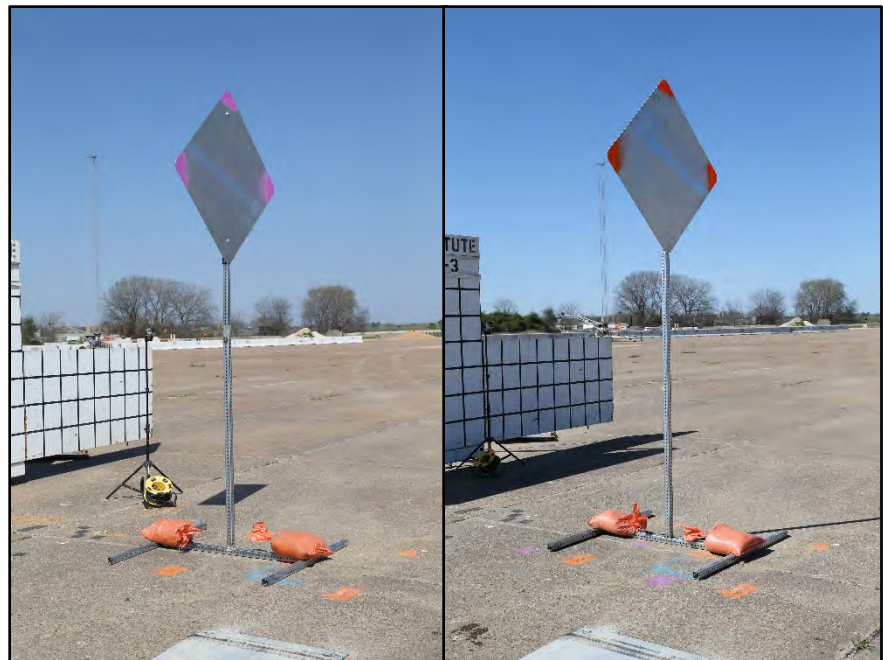

MASH EVALUATION OF TxDOT HIGH-MOUNTING-HEIGHT TEMPORARY WORK ZONE SIGN SUPPORT SYSTEM



ACCREDITED
ISO 17025 Laboratory
Testing Certificate # 2821.01

Crash testing performed at:
TTI Proving Ground
3100 SH 47, Building 7091
Bryan, TX 77807

Test Report 9-1002-15-8

Cooperative Research Program

**TEXAS A&M TRANSPORTATION INSTITUTE
COLLEGE STATION, TEXAS**

TEXAS DEPARTMENT OF TRANSPORTATION

in cooperation with the
Federal Highway Administration and the
Texas Department of Transportation
<http://tti.tamu.edu/documents/9-1002-15-8.pdf>

1. Report No. FHWA/TX-16/9-1002-15-8		2. Government Accession No.		3. Recipient's Catalog No.	
4. Title and Subtitle MASH EVALUATION OF TXDOT HIGH-MOUNTING-HEIGHT TEMPORARY WORK ZONE SIGN SUPPORT SYSTEM				5. Report Date February 2017	
				6. Performing Organization Code	
7. Author(s) Chiara S. Dobrovolny, Dusty R. Arrington, Roger P. Bligh, Wanda L. Menges, and Darrell L. Kuhn				8. Performing Organization Report No. Test Report No. 9-1002-15-8	
9. Performing Organization Name and Address Texas A&M Transportation Institute College Station, Texas 77843-3135				10. Work Unit No. (TRAIS)	
				11. Contract or Grant No. Project 9-1002-15	
12. Sponsoring Agency Name and Address Texas Department of Transportation Research and Technology Implementation Office 125 E. 11th Street Austin, Texas 78701-2483				13. Type of Report and Period Covered Technical Report: September 2015–August 2016	
				14. Sponsoring Agency Code	
15. Supplementary Notes Project performed in cooperation with the Texas Department of Transportation and the Federal Highway Administration. Project Title: Roadside Safety Device Crash Testing URL: http://tti.tamu.edu/documents/9-1002-15-8.pdf					
16. Abstract <p>The objective of this research was to develop a nonproprietary, lightweight, crashworthy, temporary work-zone single sign support for use with an aluminum sign substrate. The device is intended to meet the evaluation criteria in American Association of State Highway and Transportation Officials <i>Manual for Assessing Safety Hardware (MASH)</i>. In addition to crashworthiness, consideration was given to cost, functionality, and accommodating a high-mounting-height (7 ft). An aluminum sign substrate was also a design requirement stipulated by the Texas Department of Transportation. Texas A&M Transportation Institute researchers used perforated steel tubing for the frame of the new temporary single sign support system to accommodate the requests for a lightweight, durable, and easy to assemble structure. Slip joints were incorporated into the vertical support to help mitigate the severity of secondary contact between the sign substrate and roof of the impacting vehicle.</p> <p>The proposed design options were full-scale crash tested with an 1100C and 2270P vehicles under required <i>MASH</i> TL-3 conditions. Two out of the three proposed new designs for temporary work zone sign supports functioned acceptably under the impacted <i>MASH</i> TL-3 conditions. A third design was judged to have potential for intrusion into the occupant compartment due to a tear in the roof of the 2270P vehicle during <i>MASH</i> Test 3-72 at 90 degrees.</p>					
17. Key Words Work Zone Traffic Devices, Temporary Sign Supports, Lightweight Sign Support System, High-Mounting-Height Sign Support, Crash Testing, Roadside Safety.			18. Distribution Statement No restrictions. This document is available to the public through NTIS: National Technical Information Service Alexandria, Virginia http://www.ntis.gov		
19. Security Classif.(of this report) Unclassified		20. Security Classif.(of this page) Unclassified		21. No. of Pages 170	22. Price

**MASH EVALUATION OF TXDOT HIGH-MOUNTING-HEIGHT
TEMPORARY WORK ZONE SIGN SUPPORT SYSTEM**

by

Chiara S. Dobrovolny, Ph.D.
Associate Research Scientist
Texas A&M Transportation Institute

Dusty R. Arrington
Associate Transportation Researcher
Texas A&M Transportation Institute

Roger P. Bligh, Ph.D., P.E.
Associate Research Scientist
Texas A&M Transportation Institute

Wanda L. Menges
Research Specialist
Texas A&M Transportation Institute

and

Darrell L. Kuhn, P.E.
Research Specialist
Texas A&M Transportation Institute

Report 9-1002-15-8
Project 9-1002-15
Project Title: Roadside Safety Device Crash Testing

Performed in cooperation with the
Texas Department of Transportation
and the
Federal Highway Administration

February 2017

TEXAS A&M TRANSPORTATION INSTITUTE
College Station, Texas 77843-3135

DISCLAIMER

This research was performed in cooperation with the Texas Department of Transportation (TxDOT) and the Federal Highway Administration (FHWA). The contents of this report reflect the views of the authors, who are responsible for the facts and the accuracy of the data presented herein. The contents do not necessarily reflect the official view or policies of the FHWA or TxDOT. This report does not constitute a standard, specification, or regulation. This report is not intended for construction, bidding, or permit purposes. The engineer in charge of the project was Roger P. Bligh, Texas Professional Engineer #78550. The United States Government and the State of Texas do not endorse products or manufacturers. Trade or manufacturers' names appear herein solely because they are considered essential to the object of this report.

TTI PROVING GROUND DISCLAIMER

The results of the crash testing reported herein apply only to the article being tested.

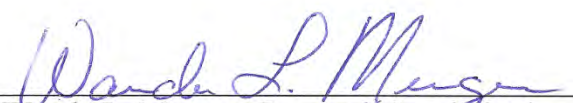

Wanda L. Menges, Research Specialist /
Deputy Quality Manager

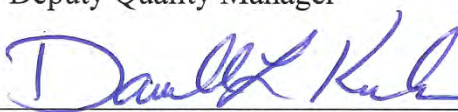
Darrell L. Kuhn, P.E., Research Specialist /
Quality Manager

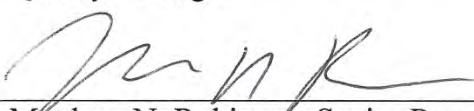
Matthew N. Robinson, Senior Research
Specialist / Test Facility Manager

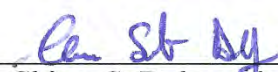
Chiara S. Dobrovolsky, Ph.D. Associate
Research Scientist/Principal Investigator

ACKNOWLEDGMENTS

This project was conducted in cooperation with TxDOT and FHWA. The TxDOT project manager for this research was Wade Odell, P.E., Research and Technology Implementation Office. Michael Chacon, P.E., TxDOT Traffic Operations Division, provided valuable technical support. The authors acknowledge and appreciate their guidance and assistance.

TABLE OF CONTENTS

	Page
List of Figures	xi
List of Tables	xiv
Chapter 1. Introduction	1
1.1. Research Problem Statement	1
1.2. Research Objectives.....	1
Chapter 2. Design Alternatives	3
2.1. High-Mounting Sign Supports with Aluminum Signs	3
2.2. Design Alternatives.....	3
Chapter 3. Test Requirements and Evaluation Criteria	5
3.1. Crash Test Matrix	5
3.2. Evaluation Criteria.....	5
Chapter 4. Test Conditions	7
4.1. Test Facility	7
4.2. Vehicle Tow and Guidance System.....	7
4.3. Data Acquisition Systems.....	7
4.3.1. Vehicle Instrumentation and Data Processing	7
4.3.2. Anthropomorphic Dummy Instrumentation	8
4.3.3. Photographic Instrumentation Data Processing.....	8
Chapter 5. Option A Temporary Work Zone Sign Support	9
5.1. Option A Design and Construction.....	9
5.2. <i>MASH</i> Test 3-72 at 90 Degrees (Crash Test No. 490026-2-1)	9
5.2.1. Test Designation and Actual Impact Conditions	9
5.2.2. Weather Conditions	13
5.2.3. Test Vehicle	13
5.2.4. Test Description.....	14
5.2.5. Damage to Test Installation	14
5.2.6. Vehicle Damage.....	15
5.2.7. Occupant Risk Factors	16
5.2.8. Assessment of Test Results.....	17
5.2.9. Conclusions.....	18
Chapter 6. Option B Temporary Work Zone Sign Support	21
6.1. Option B Design and Construction.....	21
6.2. <i>MASH</i> Test 3-72 at 90 Degrees (Crash Test No. 490026-2-2)	25
6.2.1. Test Designation and Actual Impact Conditions	25
6.2.2. Weather Conditions	25
6.2.3. Test Vehicle	26
6.2.4. Test Description.....	26
6.2.5. Damage to Test Installation	26
6.2.6. Vehicle Damage.....	27
6.2.7. Occupant Risk Factors	29
6.2.8. Assessment of Test Results.....	29
6.2.9. Conclusions.....	30

TABLE OF CONTENTS (CONTINUED)

	Page
6.3 MASH Test 3-71 at 90 Degrees (Crash Test No. 490026-2-4)	32
6.3.1 Test Designation and Actual Impact Conditions	32
6.3.2 Weather Conditions	32
6.3.3 Test Vehicle	33
6.3.4 Test Description	33
6.3.5 Damage to Test Installation	33
6.3.6 Vehicle Damage	34
6.3.7 Occupant Risk Factors	35
6.3.8 Assessment of Test Results	36
6.3.9 Conclusions	37
6.4 MASH Test 3-71 at 0 Degrees (Crash Test No. 490026-2-6)	39
6.4.1 Test Designation and Actual Impact Conditions	39
6.4.2 Weather Conditions	39
6.4.3 Test Vehicle	40
6.4.4 Test Description	40
6.4.5 Damage to Test Installation	40
6.4.6 Vehicle Damage	41
6.4.7 Occupant Risk Factors	42
6.4.8 Assessment of Test Results	43
6.4.9 Conclusions	44
6.5 MASH Test 3-72 at 0 Degrees (Crash Test No. 490026-2-8)	46
6.5.1 Test Designation and Actual Impact Conditions	46
6.5.2 Weather Conditions	46
6.5.3 Test Vehicle	47
6.5.4 Test Description	47
6.5.5 Damage to Test Installation	47
6.5.6 Vehicle Damage	48
6.5.7 Occupant Risk Factors	49
6.5.8 Assessment of Test Results	49
6.5.9 Conclusions	51
Chapter 7. Option C Temporary Work Zone Sign Support	53
7.1 Option C Design and Construction	53
7.2 MASH Test 3-72 at 90 Degrees (Crash Test No. 490026-2-3)	53
7.2.1 Test Designation and Actual Impact Conditions	53
7.2.2 Weather Conditions	57
7.2.3 Test Vehicle	57
7.2.4 Test Description	58
7.2.5 Damage to Test Installation	58
7.2.6 Vehicle Damage	59
7.2.7 Occupant Risk Factors	60
7.2.8 Assessment of Test Results	61
7.2.9 Conclusions	62

TABLE OF CONTENTS (CONTINUED)

	Page
7.3 MASH Test 3-71 at 90 Degrees (Crash Test No. 490026-2-5)	64
7.3.1 Test Designation and Actual Impact Conditions	64
7.3.2 Weather Conditions	64
7.3.3 Test Vehicle	65
7.3.4 Test Description	65
7.3.5 Damage to Test Installation	65
7.3.6 Vehicle Damage	66
7.3.7 Occupant Risk Factors	67
7.3.8 Assessment of Test Results	68
7.3.9 Conclusions	69
7.4 MASH Test 3-71 at 0 Degrees (Crash Test No. 490026-2-7)	71
7.4.1 Test Designation and Actual Impact Conditions	71
7.4.2 Weather Conditions	71
7.4.3 Test Vehicle	72
7.4.4 Test Description	72
7.4.5 Damage to Test Installation	72
7.4.6 Vehicle Damage	73
7.4.7 Occupant Risk Factors	74
7.4.8 Assessment of Test Results	75
7.4.9 Conclusions	76
7.5 MASH Test 3-72 at 0 Degrees (Crash Test No. 490026-2-9)	78
7.5.1 Test Designation and Actual Impact Conditions	78
7.5.2 Weather Conditions	78
7.5.3 Test Vehicle	79
7.5.4 Test Description	79
7.5.5 Damage to Test Installation	79
7.5.6 Vehicle Damage	80
7.5.7 Occupant Risk Factors	81
7.5.8 Assessment of Test Results	81
7.5.9 Conclusions	83
Chapter 8. Summary and Conclusions	85
8.1 Assessment of Test Results	85
8.1.1 Option A Temporary Work Zone Sign Support	85
8.1.2 Option B Temporary Work Zone Sign Support	85
8.1.3 Option C Temporary Work Zone Sign Support	85
8.2 Conclusions	86
Chapter 9. Implementation Statement	97
References	99
Appendix A. Crash Test No. 490026-2-1 (MASH Test 3-72)	101
A1 Vehicle Properties and Information	101
A2 Sequential Photographs	105

TABLE OF CONTENTS (CONTINUED)

	Page
Appendix B. Crash Test No. 490026-2-2 (MASH Test 3-72)	107
B1 Vehicle Properties and Information	107
B2 Sequential Photographs.....	111
Appendix C. Crash Test No. 490026-2-4 (MASH Test 3-71)	113
C1 Vehicle Properties and Information	113
C2 Sequential Photographs.....	116
Appendix D. Crash Test No. 490026-2-6 (MASH Test 3-71)	119
D1 Vehicle Properties and Information	119
D2 Sequential Photographs.....	122
Appendix E. Crash Test No. 490026-2-8 (MASH Test 3-72)	125
E1 Vehicle Properties and Information	125
E2 Sequential Photographs.....	129
Appendix F. Crash Test No. 490026-2-3 (MASH Test 3-72)	131
F1 Vehicle Properties and Information	131
F2 Sequential Photographs.....	135
Appendix G. Crash Test No. 490026-2-5 (MASH Test 3-71)	137
G1 Vehicle Properties and Information	137
G2 Sequential Photographs.....	140
Appendix H. Crash Test No. 490026-2-7 (MASH Test 3-71)	143
H1 Vehicle Properties and Information	143
H2 Sequential Photographs.....	146
Appendix I. Crash Test No. 490026-2-9 (MASH Test 3-72)	149
I1 Vehicle Properties and Information	149
I2 Sequential Photographs.....	153

LIST OF FIGURES

	Page
Figure 5.1. Details of the Option A Temporary Work Zone Sign Support.....	10
Figure 5.2. Option A Temporary Work Zone Sign Support Used for Test No. 490026-2-1.	13
Figure 5.3. Test Vehicle before Test No. 490026-2-1.....	14
Figure 5.4. Option A Temporary Work Zone Sign Support after Test No. 490026-2-1.....	15
Figure 5.5. Test Vehicle after Test No. 490026-2-1.	16
Figure 5.6. Interior of Test Vehicle after Test No. 490026-2-1.	16
Figure 5.7. Summary of Results for <i>MASH</i> Test 3-72 at 90 Degrees on the Option A Temporary Work Zone Sign Support.	19
Figure 6.1. Details of the Option B Temporary Work Zone Sign Support.	22
Figure 6.2. Option B Temporary Work Zone Sign Support Used for Test No. 490026-2-2.	25
Figure 6.3. Test Vehicle before Test No. 490026-2-2.....	26
Figure 6.4. Option B Temporary Work Zone Sign Support after Test No. 490026-2-2.	27
Figure 6.5. Test Vehicle after Test No. 490026-2-2.	28
Figure 6.6. Interior of Test Vehicle for Test No. 490026-2-2.	28
Figure 6.7. Summary of Results for <i>MASH</i> Test 3-72 at 90 Degrees on the Option B Temporary Work Zone Sign Support.	31
Figure 6.8. Option B Temporary Work Zone Sign Support Used for Test No. 490026-2-4.	32
Figure 6.9. Test Vehicle before Test No. 490026-2-4.....	33
Figure 6.10. Option B Temporary Work Zone Sign Support after Test No. 490026-2-4.	34
Figure 6.11. Test Vehicle after Test No. 490026-2-4.	35
Figure 6.12. Interior of Test Vehicle for Test No. 490026-2-4.	35
Figure 6.13. Summary of Results for <i>MASH</i> Test 3-71 at 90 Degrees on the Option B Temporary Work Zone Sign Support.	38
Figure 6.14. Option B Temporary Work Zone Sign Support Used for Test No. 490026-2-6.	39
Figure 6.15. Test Vehicle before Test No. 490026-2-6.....	40
Figure 6.16. Option B Temporary Work Zone Sign Support after Test No. 490026-2-6.	41
Figure 6.17. Test Vehicle after Test No. 490026-2-6.	42
Figure 6.18. Interior of Test Vehicle for Test No. 490026-2-6.....	42
Figure 6.19. Summary of Results for <i>MASH</i> Test 3-71 at 0 Degrees on the Option B Temporary Work Zone Sign Support.	45
Figure 6.20. Option A Temporary Work Zone Sign Support Used for Test No. 490026-2-8.	46
Figure 6.21. Test Vehicle before Test No. 490026-2-8.....	47
Figure 6.22. Option A Temporary Work Zone Sign Support after Test No. 490026-2-8.....	48
Figure 6.23. Test Vehicle after Test No. 490026-2-8.	49
Figure 6.24. Interior of Test Vehicle after Test No. 490026-2-8.	49
Figure 6.25. Summary of Results for <i>MASH</i> Test 3-72 at 0 Degrees on the Option B Temporary Work Zone Sign Support.	52

LIST OF FIGURES (CONTINUED)

	Page
Figure 7.1. Details of the Option C Temporary Work Zone Sign Support.....	54
Figure 7.2. Option C Temporary Work Zone Sign Support Used for Test No. 490026-2-3.....	57
Figure 7.3. Test Vehicle before Test No. 490026-2-3.....	58
Figure 7.4. Option C Temporary Work Zone Sign Support after Test No. 490026-2-3.....	59
Figure 7.5. Test Vehicle after Test No. 490026-2-3.....	60
Figure 7.6. Interior of Test Vehicle for Test No. 490026-2-3.....	60
Figure 7.7. Summary of Results for <i>MASH</i> Test 3-72 at 90 Degrees on the Option C Temporary Work Zone Sign Support.....	63
Figure 7.8. Option C Temporary Work Zone Sign Support Used for Test No. 490026-2-5.....	64
Figure 7.9. Test Vehicle before Test No. 490026-2-5.....	65
Figure 7.10. Option C Temporary Work Zone Sign Support after Test No. 490026-2-5.....	66
Figure 7.11. Test Vehicle after Test No. 490026-2-5.....	67
Figure 7.12. Interior of Test Vehicle for Test No. 490026-2-5.....	67
Figure 7.13. Summary of Results for <i>MASH</i> Test 3-71 at 90 Degrees on the Option C Temporary Work Zone Sign Support.....	70
Figure 7.14. Option C Temporary Work Zone Sign Support Used for Test No. 490026-2-7.....	71
Figure 7.15. Test Vehicle before Test No. 490026-2-7.....	72
Figure 7.16. Option C Temporary Work Zone Sign Support after Test No. 490026-2-7.....	73
Figure 7.17. Test Vehicle after Test No. 490026-2-7.....	74
Figure 7.18. Interior of Test Vehicle for Test No. 490026-2-7.....	74
Figure 7.19. Summary of Results for <i>MASH</i> Test 3-71 at 0 Degrees on the Option C Temporary Work Zone Sign Support.....	77
Figure 7.20. Option C Temporary Work Zone Sign Support Used for Test No. 490026-2-9.....	78
Figure 7.21. Test Vehicle before Test No. 490026-2-9.....	79
Figure 7.22. Option C Temporary Work Zone Sign Support after Test No. 490026-2-9.....	80
Figure 7.23. Test Vehicle after Test No. 490026-2-9.....	81
Figure 7.24. Interior of Test Vehicle for Test No. 490026-2-9.....	81
Figure 7.25. Summary of Results for <i>MASH</i> Test 3-72 at 0 Degrees on the Option C Temporary Work Zone Sign Support.....	84
Figure A.1. Sequential Photographs for Test No. 490026-2-1 (Perpendicular and Oblique Views).....	105
Figure B.1. Sequential Photographs for Test No. 490026-2-2 (Perpendicular and Oblique Views).....	111
Figure C.1. Sequential Photographs for Test No. 490026-2-4 (Perpendicular and Oblique Views).....	116
Figure D.1. Sequential Photographs for Test No. 490026-2-6 (Perpendicular and Oblique Views).....	122

LIST OF FIGURES (CONTINUED)

	Page
Figure E.1. Sequential Photographs for Test No. 490026-2-8 (Perpendicular and Oblique Views).	129
Figure F.1. Sequential Photographs for Test No. 490026-2-3 (Perpendicular and Oblique Views).	135
Figure G.1. Sequential Photographs for Test No. 490026-2-5 (Perpendicular and Oblique Views).	140
Figure H.1. Sequential Photographs for Test No. 490026-2-7 (Perpendicular and Oblique Views).	146
Figure I.1. Sequential Photographs for Test No. 490026-2-9 (Perpendicular and Oblique Views).	153

LIST OF TABLES

		Page
Table 8.1.	Performance Evaluation Summary for <i>MASH</i> Test 3-72 at 90 Degrees on the Option A Temporary Work Zone Sign Support.....	87
Table 8.2.	Performance Evaluation Summary for <i>MASH</i> Test 3-72 at 90 Degrees on the Option B Temporary Work Zone Sign Support.....	88
Table 8.3.	Performance Evaluation Summary for <i>MASH</i> Test 3-71 at 90 Degrees on the Option B Temporary Work Zone Sign Support.....	89
Table 8.4.	Performance Evaluation Summary for <i>MASH</i> Test 3-71 at 0 Degrees on the Option B Temporary Work Zone Sign Support.....	90
Table 8.5.	Performance Evaluation Summary for <i>MASH</i> Test 3-72 at 0 Degrees on the Option B Temporary Work Zone Sign Support.....	91
Table 8.6.	Performance Evaluation Summary for <i>MASH</i> Test 3-72 at 90 Degrees on the Option C Temporary Work Zone Sign Support.....	92
Table 8.7.	Performance Evaluation Summary for <i>MASH</i> Test 3-71 at 90 Degrees on the Option C Temporary Work Zone Sign Support.....	93
Table 8.8.	Performance Evaluation Summary for <i>MASH</i> Test 3-71 at 0 Degrees on the Option C Temporary Work Zone Sign Support.....	94
Table 8.9.	Performance Evaluation Summary for <i>MASH</i> Test 3-72 at 0 Degrees on the Option C Temporary Work Zone Sign Support.....	95
Table A.1.	Vehicle Properties for Test No. 490026-2-1 through 490026-2-3.....	101
Table A.2.	Measurements of Vehicle Vertical CG for Test No. 490026-2-1 through 490026-2-3.....	102
Table A.3.	Exterior Crush Measurements for Test No. 490026-2-1.....	103
Table A.4.	Occupant Compartment Measurements for Test No. 490026-2-1.....	104
Table B.1.	Vehicle Properties for Test No. 490026-2-2.....	107
Table B.2.	Measurements of Vehicle Vertical CG for Test No. 490026-2-2.....	108
Table B.3.	Exterior Crush Measurements for Test No. 490026-2-2.....	109
Table B.4.	Occupant Compartment Measurements for Test No. 490026-2-2.....	110
Table C.1.	Vehicle Properties for Test Nos. 490026-2-4.....	113
Table C.2.	Exterior Crush Measurements for Test No. 490026-2-4.....	114
Table C.3.	Occupant Compartment Measurements for Test No. 490026-2-4.....	115
Table D.1.	Vehicle Properties for Test No. 490026-2-6.....	119
Table D.2.	Exterior Crush Measurements for Test No. 490026-2-6.....	120
Table D.3.	Occupant Compartment Measurements for Test No. 490026-2-6.....	121
Table E.1.	Vehicle Properties for Test No. 490026-2-8.....	125
Table E.2.	Measurements of Vehicle Vertical CG for Test No. 490026-2-8.....	126
Table E.3.	Exterior Crush Measurements for Test No. 490026-2-8.....	127
Table E.4.	Occupant Compartment Measurements for Test No. 490026-2-8.....	128
Table F.1.	Vehicle Properties for Test No. 490026-2-3.....	131
Table F.2.	Measurements of Vehicle Vertical CG for Test No. 490026-2-3.....	132
Table F.3.	Exterior Crush Measurements for Test No. 490026-2-3.....	133
Table F.4.	Occupant Compartment Measurements for Test No. 490026-2-3.....	134

LIST OF TABLES (CONTINUED)

	Page
Table G.1. Vehicle Properties for Test No. 490026-2-5.....	137
Table G.2. Exterior Crush Measurements for Test No. 490026-2-5.	138
Table G.3. Occupant Compartment Measurements for Test No. 490026-2-5.....	139
Table H.1. Vehicle Properties for Test No. 490026-2-7.....	143
Table H.2. Exterior Crush Measurements for Test No. 490026-2-7.	144
Table H.3. Occupant Compartment Measurements for Test No. 490026-2-7.....	145
Table I.1. Vehicle Properties for Test No. 490026-2-9.....	149
Table I.2. Measurements of Vehicle Vertical CG for Test No. 490026-2-9.....	150
Table I.3. Exterior Crush Measurements for Test No. 490026-2-9.	151
Table I.4. Occupant Compartment Measurements for Test No. 490026-2-9.....	152

Chapter 1. INTRODUCTION

1.1. RESEARCH PROBLEM STATEMENT

Work zone traffic control devices, such as temporary single sign supports, are a primary means to communicate information to motorists in work zone areas. The Federal Highway Administration (FHWA) and the *Manual on Uniform Traffic Control Devices* require work zone traffic control devices to be crashworthy (1). The American Association of State Highway and Transportation Officials (AASHTO) *Manual for Assessing Safety Hardware (MASH)* contains procedures recommended for testing and evaluation of work zone traffic control devices (2).

State maintenance personnel and contractors prefer lightweight sign support systems that are easy to handle and transport. Temporary work zone sign support systems fabricated from perforated steel tubing are relatively lightweight compared to other materials such as timber. When galvanized, perforated steel tubing also provides good durability and resistance to environmental attack and does not need painting, which is a maintenance requirement for timber systems.

An existing temporary single sign support system fabricated from perforated steel tubing requires the use of a corrugated plastic sign panel. The Texas Department of Transportation (TxDOT) expressed a desire to develop a nonproprietary, lightweight, and crashworthy temporary single sign support system that uses an aluminum sign substrate, which is stiffer and more durable than the corrugated plastic signs.

1.2. RESEARCH OBJECTIVES

The objective of this research was to develop a nonproprietary, lightweight, and crashworthy temporary work-zone single sign support system with an aluminum sign substrate. The device is intended to meet the evaluation criteria in *MASH*. In addition to crashworthiness, consideration was given to cost, functionality, and accommodation of a high-mounting-height (7 ft). The use of an aluminum sign substrate was also a stipulated requirement.

Test results and recommendations from a previous research study were reviewed (3). Three different design concepts were developed for evaluation. Texas A&M Transportation Institute (TTI) researchers used perforated steel tubing for the frame of the new temporary single sign support system to accommodate the requests for a lightweight, durable, and easy to assemble system. Slip joints were incorporated into the vertical support to help mitigate the severity of secondary contact between the sign substrate and roof of the impacting vehicle.

This report summarizes the findings of the project. Chapter 2 presents the design criteria for the work zone devices to be tested. Chapter 3 describes testing requirements for work-zone devices. Chapter 4 describes the test facility, test vehicle guidance, and instrumentation. Chapters 5 through 7 contain details of the crash tests performed on the three design options evaluated. Chapter 8 contains a summary and conclusions of the testing performed. Chapter 9 provides implementation recommendations for the temporary single sign support designs.

Chapter 2. DESIGN ALTERNATIVES

2.1. HIGH-MOUNTING SIGN SUPPORTS WITH ALUMINUM SIGNS

While rigid sign substrate materials may be desirable for improved durability, their rigidity and mass can make them more critical than other substrate materials, from a crashworthiness standpoint, in certain orientations. In particular, impacts with high-mounting-height sign supports oriented 90 degrees to the travel path of the vehicle have caused the rigid substrate to penetrate the windshield and/or the roof sheet metal. Therefore, high-mounting-height temporary work zone sign supports with aluminum or plywood substrates must be properly designed to achieve acceptable impact performance. Some successful crash tests have involved the early release of the rigid substrate or fracture of the vertical support at or near bumper height. Combinations of design modifications can be incorporated to allow the sign panel and supports to rotate above and over the vehicle. Secondary contact may still occur between the sign components and vehicle, but the degree of damage can be mitigated to acceptable levels.

2.2. DESIGN ALTERNATIVES

The TxDOT project panel specified the use of a 36 inch × 36 inch aluminum sign at a mounting height of 7 ft. Perforated steel tubing was preferred for its light weight, durability, and ease of fabrication. Having defined the basic requirements for the system (e.g., mounting height, sign substrate, support material type and size), the researchers developed design alternatives with potential to meet impact performance requirements.

Three high-mounting-height, temporary single sign support designs were developed and evaluated through full-scale crash testing. Design details and test results for each of the three options are presented in Chapters 5 through 7.

Chapter 3. TEST REQUIREMENTS AND EVALUATION CRITERIA

3.1. CRASH TEST MATRIX

According to *MASH*, three tests are recommended to evaluate work-zone support structures to test level three (TL-3):

MASH Test Designation 3-70: A 2425 lb vehicle impacting the support structure at a nominal impact speed of 19 mi/h. This test is recommended to evaluate the potential for test article intrusion through the windshield or roof of a small passenger car when impacting the test article at a low speed.

MASH Test Designation 3-71: A 2425 lb vehicle impacting the support structure at a nominal impact speed of 62 mi/h. This test is recommended to evaluate the potential for test article intrusion through the windshield or roof of a small passenger car when impacting the test article at a high speed.

MASH Test Designation 3-72: A 5000 lb pickup truck impacting the support structure at a nominal impact speed and angle of 62 mi/h. This test is recommended to evaluate the potential for test article intrusion through the windshield or roof of a light truck vehicle when impacting the test article at a high speed.

FHWA/AASHTO requires the impact performance of temporary work zone sign supports be evaluated for two different orientations. In addition to the common scenario involving the vehicle impacting the device head-on (i.e., 0 deg.), an impact with the device turned 90 degrees is also required. This test condition accounts for the common field practice of rotating a device out of view of traffic until it is needed again and/or picked up and moved by work zone personnel.

The tests reported herein correspond to *MASH* Test 3-71 (2425-lb passenger car, 62 mi/h, 90- and 0-degree sign orientation) and *MASH* Test 3-72 (5000-lb pickup, 62 mi/h, 90- and 0-degree sign orientation). *MASH* Test 3-70 was deemed to be unnecessary for the successful performance of the considered devices.

The crash tests and data analysis procedures were in accordance with guidelines presented in *MASH*.

3.2. EVALUATION CRITERIA

The crash test results for each test were evaluated in accordance with the criteria presented in *MASH*. The impact performance of the temporary work zone sign supports was judged based on the following factors:

- The temporary work zone sign supports should readily activate in a predictable manner by breaking away, fracturing, or yielding.

- Risk of occupant compartment deformation or intrusion by detached elements, fragments, or other debris from the temporary work zone sign supports, which evaluates the potential risk of hazard to occupants, and, to some extent, other traffic, pedestrians, or workers in construction zones, if applicable.
- Occupant risk values, for which longitudinal and lateral occupant impact velocity and ridedown accelerations for the 1100C and 2270P vehicles must be within the limits specified in *MASH*, and determines the risk of injury to the occupants.
- Detached elements, fragments, or other debris from the temporary work zone sign supports, or vehicular damage should not block the driver's vision or otherwise cause the driver to lose control of the vehicle.
- Post-impact vehicle trajectory, which considers potential for secondary impact with other vehicles or fixed objects, creating further risk of injury to occupants of the impacting vehicle and/or risk of injury to occupants in other vehicles.

The appropriate safety evaluation criteria from Table 5-1 of *MASH* were used to evaluate the crash tests reported herein. These criteria are listed in further detail under the assessment of each crash test.

Chapter 4. TEST CONDITIONS

4.1. TEST FACILITY

The full-scale crash test reported here was performed at the TTI Proving Ground, an International Standards Organization 17025-accredited laboratory with American Association for Laboratory Accreditation Mechanical Testing certificate 2821.01. The full-scale crash test was performed according to TTI Proving Ground quality procedures, and according to the *MASH* guidelines and standards.

The TTI Proving Ground is a 2000-acre complex of research and training facilities located 10 miles northwest of the main campus of Texas A&M University. The site, formerly a United States Army Air Corps base, has large expanses of concrete runways and parking aprons that are well-suited for experimental research and testing in the areas of vehicle performance and handling, vehicle-roadway interaction, durability and efficacy of highway pavements, and safety evaluation of roadside safety hardware. The site selected for construction and testing of the temporary work zone sign supports was on the surface of an existing out-of-service apron. The apron consists of an unreinforced jointed-concrete pavement in 12.5-ft × 15-ft blocks nominally 6 inches deep. The aprons were built in 1942, and the joints have some displacement, but are otherwise flat and level.

4.2 VEHICLE TOW AND GUIDANCE SYSTEM

The test vehicles were towed into the temporary work zone sign supports using a steel cable guidance and reverse tow system. A steel cable for guiding each test vehicle was tensioned along the path, anchored at each end, and threaded through an attachment to the front wheel of the test vehicle. An additional steel cable was connected to each test vehicle, passed around a pulley near the impact point, through a pulley on the tow vehicle, and then anchored to the ground such that the tow vehicle moved away from the test site. A 2:1 speed ratio between the test and tow vehicle existed with this system. Just prior to impact with the temporary work zone sign supports, the test vehicle was released and ran unrestrained. The vehicle remained freewheeling (i.e., no steering or braking inputs) until it cleared the immediate area of the test site, after which the brakes were activated, if needed, to bring each test vehicle to a safe and controlled stop.

4.3 DATA ACQUISITION SYSTEMS

4.3.1 Vehicle Instrumentation and Data Processing

MASH states “that lightweight free-standing features cannot cause sufficient velocity change to result in failure of the test under occupant risk criteria. Therefore, Tests 3-71 and 3-72 can be conducted without the instrumentation necessary for determining occupant risk whenever the test article has a total weight of 220 lb (100 kg) or less.” Consequently, the vehicles used in the testing program were un-instrumented except for a remote controlled braking package installed for safety purposes.

4.3.2 Anthropomorphic Dummy Instrumentation

An Alderson Research Laboratories Hybrid II, 50th percentile male anthropomorphic dummy, restrained with lap and shoulder belts, was placed in the front seat on the opposite side of impact in the 1100C vehicle. The dummy was not instrumented.

According to *MASH*, use of a dummy in the 2270P vehicle is optional. No dummy was used in the tests with the 2270P vehicle reported herein.

4.3.3 Photographic Instrumentation Data Processing

Photographic coverage of each test included two high-speed cameras:

- One placed behind the installation at an angle.
- Another placed to have a field of perpendicular to the vehicle path and aligned with the sign installation.

A flashbulb on each impacting vehicle was activated by a pressure-sensitive tape switch to indicate the instant of contact with each temporary work zone sign support. The flashbulb was visible from each camera. The videos from these high-speed cameras were analyzed to observe phenomena occurring during the collision and to obtain time-event, displacement, and angular data. A mini-digital video camera and still cameras recorded and documented conditions of each test vehicle and each temporary work zone sign support before and after the test.

Chapter 5. OPTION A TEMPORARY WORK ZONE SIGN SUPPORT

5.1 OPTION A DESIGN AND CONSTRUCTION

The test installation for Design Option A was fabricated using a single aluminum sign mounted on 1 $\frac{3}{4}$ -inch, 12-gauge (0.105 inch) nominal thickness perforated steel tubing containing $\frac{7}{16}$ -inch diameter holes on 1-inch spacing on all four sides. The test sign panel measured 36 inches square and was fabricated from 0.100-inch thick aluminum. The sign was mounted in a diamond configuration with a tip-to-tip distance of 49 $\frac{1}{8}$ inches as a result of each corner having a 2-inch radius. The vertical support post and sign were mounted to an H-shaped base measuring 48 inches \times 51 $\frac{1}{2}$ inches comprised of three 48-inch long sections of 1 $\frac{3}{4}$ -inch perforated steel tubing. Junctions of the 3-piece base and lower section of the segmented vertical support post were joined with fillet welds. The sign was attached to the upper section of the segmented vertical support post with two $\frac{3}{8}$ -inch diameter \times 2 $\frac{1}{2}$ -inch long SAE grade 5 hex bolts, nuts, and flat and lock washers. Two 40-lb sandbags were placed on top of the H-shaped base; one at the midpoint of each outrigger. The outriggers and sign panel were oriented parallel to the direction of impact. The approximate total weight of the test assembly was 60 lb (16-lb sign panel, 20-lb sectional vertical support post, and 24-lb 3-piece base) exclusive of the two 40-lb sandbags.

The upper and lower sections of the vertical support post were connected with an 8-inch long sleeve fabricated from 1 $\frac{1}{2}$ -inch, 12-gauge perforated steel tubing. This insert was secured in the lower section with a $\frac{3}{8}$ -inch diameter \times 2 $\frac{1}{2}$ -inch long smooth pin located in the holes 2 $\frac{1}{2}$ inches below the joint. The pin was welded to one side of the lower post once the insert was installed. The joint between the upper and lower sections of the vertical support post was located 67 $\frac{3}{4}$ inches above grade. The bottom of the aluminum sign was 83 $\frac{1}{2}$ inches above grade.

Figure 5.1 shows details of the Option A temporary work zone sign support installation. Figure 5.2 provides photographs of the completed installation.

5.2 MASH TEST 3-72 AT 90 DEGREES (CRASH TEST NO. 490026-2-1)

5.2.1 Test Designation and Actual Impact Conditions

MASH Test 3-72 involves a 2270P vehicle weighing 5000 lb \pm 110 lb impacting the Option A temporary work zone sign support with the quarter point of the front of the vehicle at an impact speed of 62.2 mi/h \pm 2.5 mi/h at the critical impact angle (CIA) \pm 1.5 degrees. The CIA for *MASH* Test 3-72 on the temporary work zone sign support was 90 degrees. The 2010 Dodge Ram 1500 pickup truck used in the test weighed 5014 lb, and the actual impact speed and angle were 62.9 mi/h and 90 degrees, respectively. The impact point was 10 inches to the right of centerline of the vehicle. The target kinetic energy (KE) was \geq 594 kip-ft, and the actual KE at impact was 663 kip-ft.

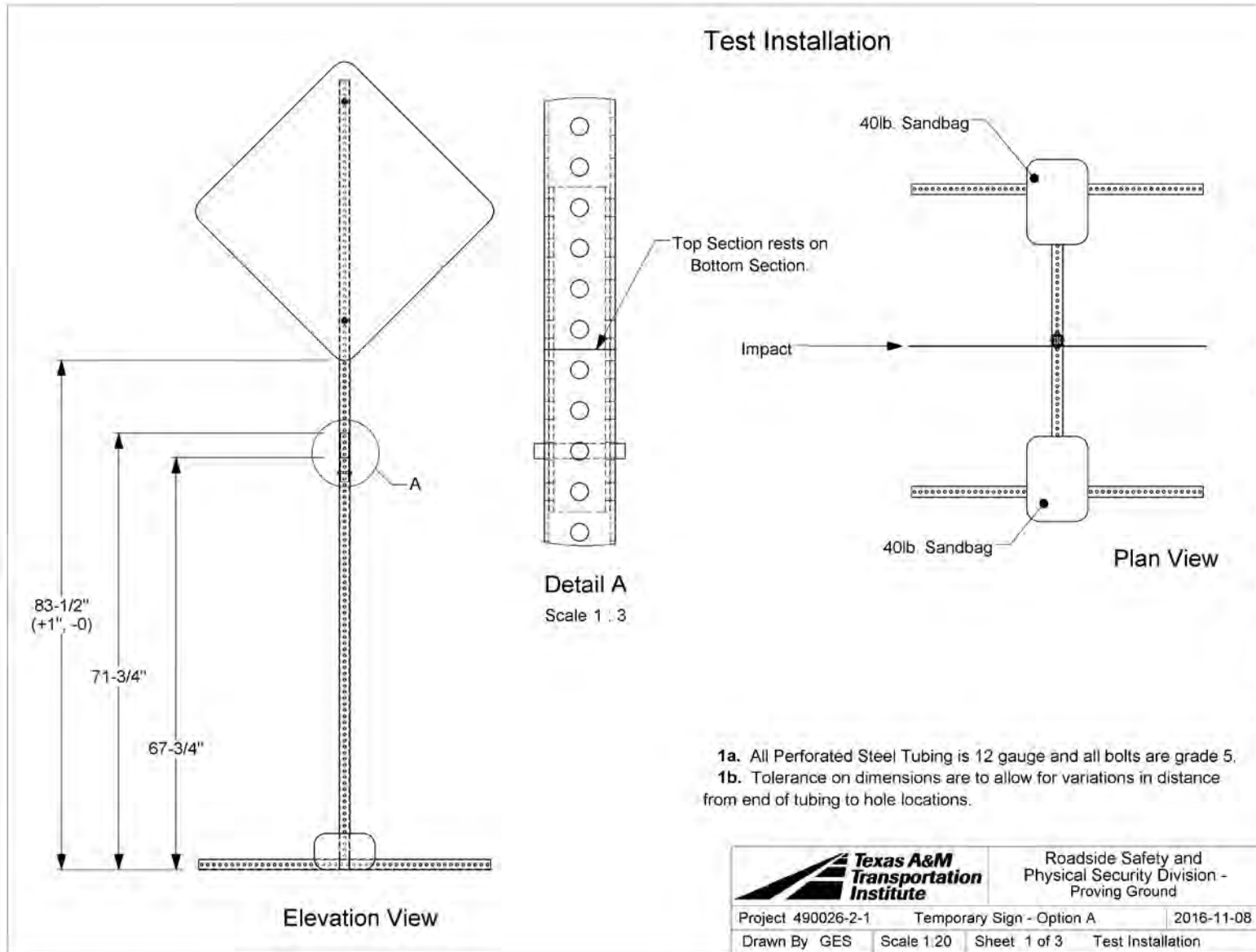

T:\1-ProjectFiles\490026-Tx\DOT\2 - Temporary Single Leg Sign Support - Chiara\2-1\Drafting\490026-2-1 Drawing

Figure 5.1. Details of the Option A Temporary Work Zone Sign Support.

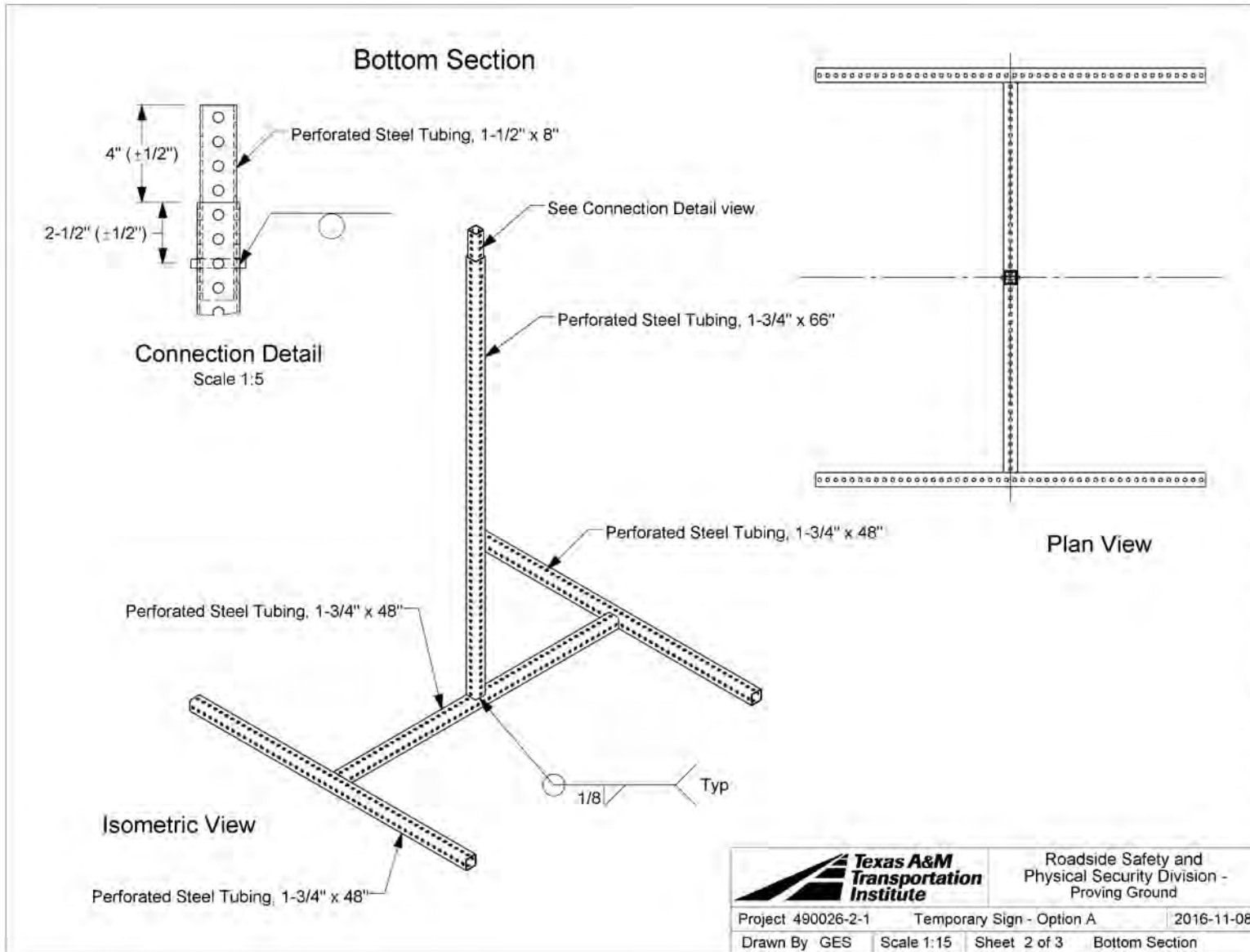

T:\11-ProjectFiles\490026-TxDO\T\2 - Temporary Single Leg Sign Support - Chiara\2-1\Drafting\490026-2-1 Drawing

Figure 5.1. Details of the Option A Temporary Work Zone Sign Support (Continued).

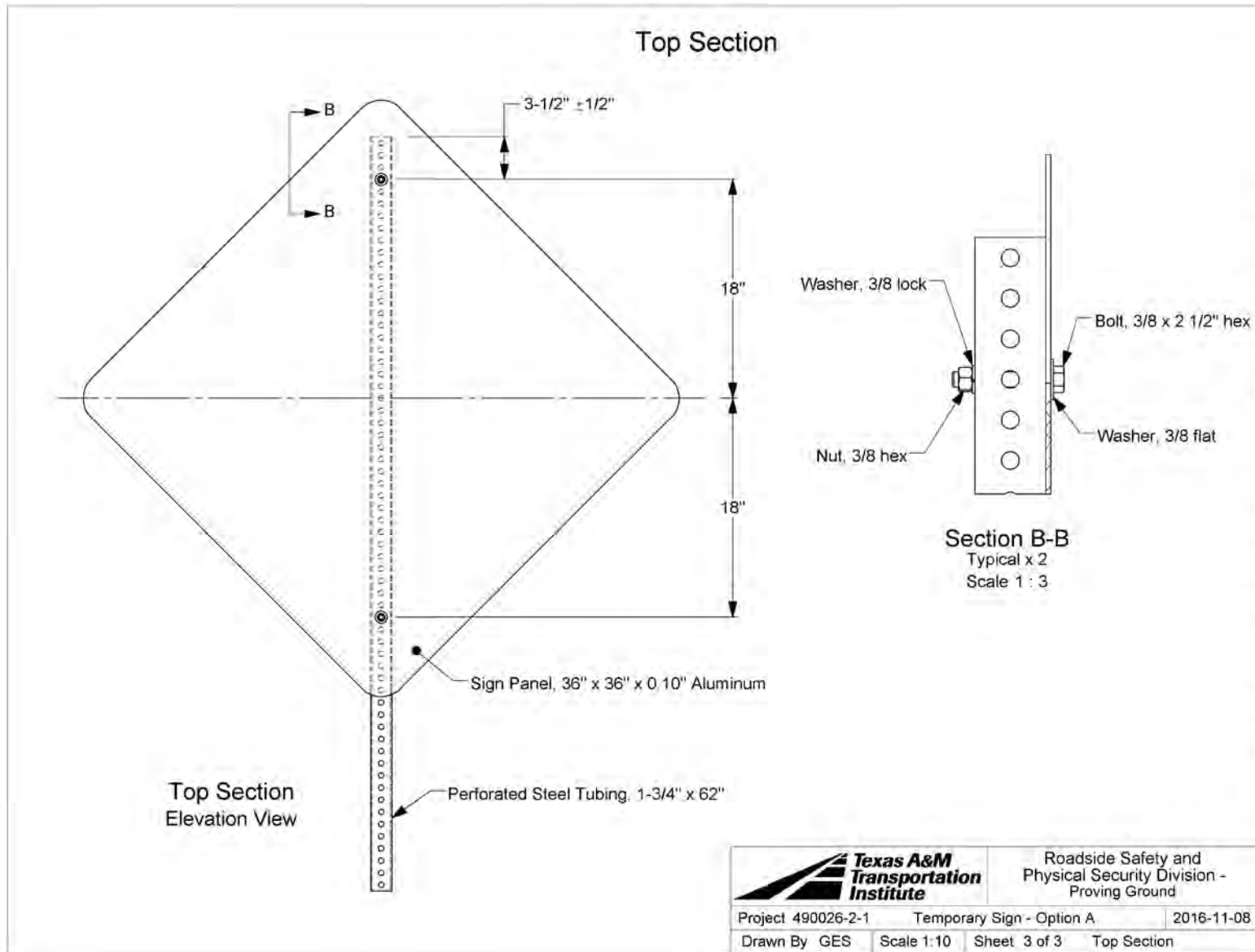

T:\1-ProjectFiles\490026-Tx\DOT\2 - Temporary Single Leg Sign Support - Chiara\2-1\Drafting\490026-2-1 Drawing

Figure 5.1. Details of the Option A Temporary Work Zone Sign Support (Continued).

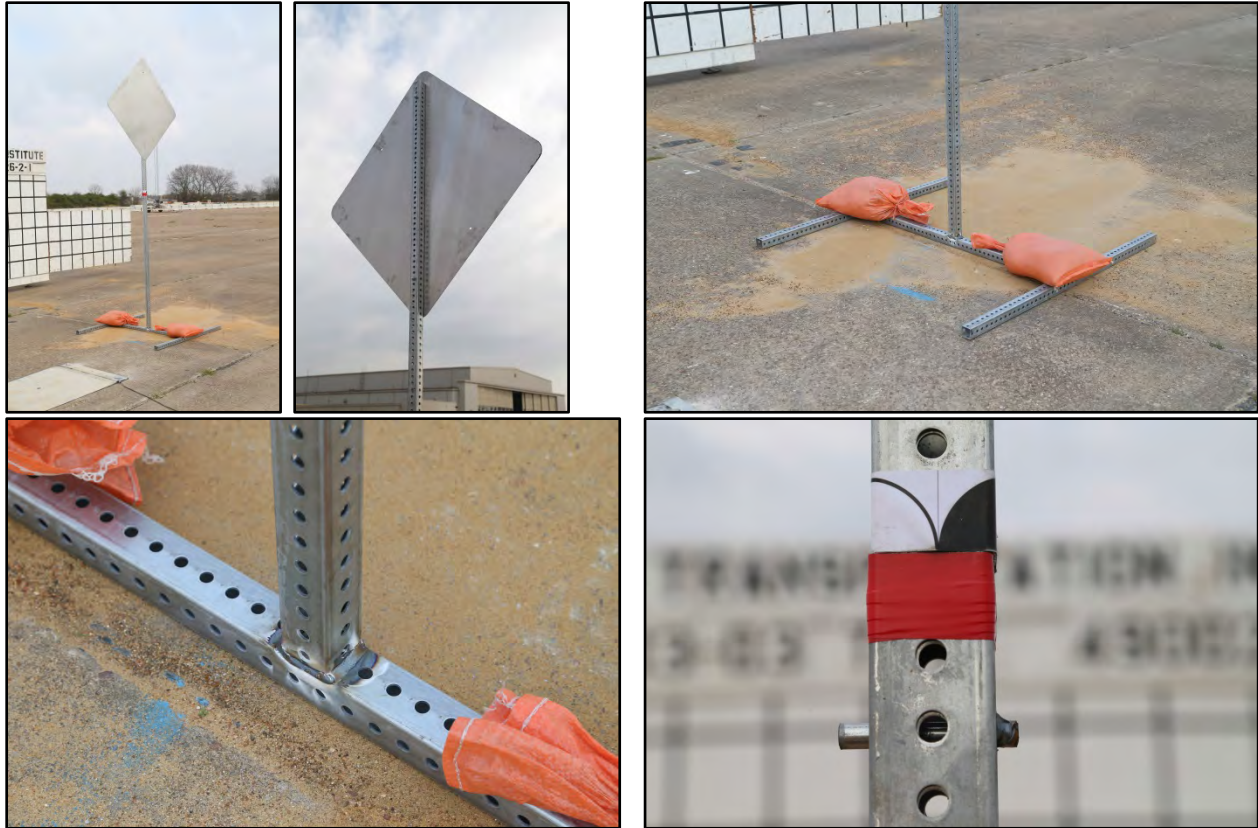

Figure 5.2. Option A Temporary Work Zone Sign Support Used for Test No. 490026-2-1.

5.2.2 Weather Conditions

The test was performed on the morning of March 3, 2016. Weather conditions at the time of testing were as follows: wind speed: 9 mi/h; wind direction: 248 degrees with respect to the vehicle (vehicle was traveling in a northerly direction); temperature: 74°F; relative humidity: 81 percent.

5.2.3 Test Vehicle

The 2010 Dodge Ram 1500 pickup, shown in Figure 5.3, was used for the crash test. The vehicle's test inertia weight was 5014 lb, and its gross static weight was 5014 lb. The height to the lower edge of the vehicle bumper was 12.5 inches, and the height to the upper edge of the vehicle bumper was 27.5 inches. The height to the vehicle's center of gravity was 28.4 inches. Tables A.1 and A.2 in Appendix A1 give additional dimensions and information on the vehicle. The vehicle was directed into the installation using a cable reverse tow and guidance system, and was released to be freewheeling and unrestrained just prior to impact.



Figure 5.3. Test Vehicle before Test No. 490026-2-1.

5.2.4 Test Description

The 2010 Dodge Ram 1500 pickup, traveling at an impact speed of 62.9 mi/h, contacted the Option A temporary work zone sign support 10 inches to the right of centerline of the vehicle at an impact angle of 90 degrees. At 0.003 s after impact, the support contacted the upper grill, and at 0.004 s, the base of the support began to lift off the concrete pavement. The right front tire contacted the base at 0.008 s, and the upper section of the vertical support began to release from the lower section of the vertical support at 0.009 s. At 0.012 s, the lower section of the vertical support began to rupture at bumper height, and at 0.020 s, the upper section of the vertical support lost contact with the lower section of the vertical support. The lower section of the support contacted the concrete pavement at 0.071 s, and the sign panel contacted the right side of the roof 8.5 inches behind the top of the windshield at 0.079 s. A corner of the sign panel contacted the right rear of the roof at 0.117 s and lost contact with the roof at 0.140 s. At loss of contact with the sign panel, the vehicle was traveling at a speed of 61.8 mi/h. Brakes on the vehicle were applied after loss of contact with the sign panel, and the vehicle came to rest 280 ft downstream from the point of impact and 38 ft to the right of centerline of the impact path. Figure A.1 in Appendix A2 presents sequential photographs during the test.

5.2.5 Damage to Test Installation

Figure 5.4 shows the damage to the Option A temporary work zone sign support. The sign panel and a portion of the upright came to rest 20 ft downstream of impact and 6 ft to the right of centerline of the impact path. The lower section of the vertical support post fractured 24 inches above grade and the fractured section came to rest 29 ft downstream and 5 ft to the right of centerline. The H-shaped base with the remaining piece of the lower section of the vertical support post came to rest 98 ft downstream of impact and 12 ft left of centerline of the impact path.



Figure 5.4. Option A Temporary Work Zone Sign Support after Test No. 490026-2-1.

5.2.6 Vehicle Damage

Figure 5.5 shows the damage sustained by the vehicle. The bumper, hood, grill, and roof were damaged. Maximum exterior crush to the vehicle was 2.5 inches in the front plane at the right quarter point at bumper height. On the rear of the roof, there was a 16-inch long scratch that ended in a 5-inch long tear on the outer surface. The cut did not extend into the passenger compartment. The interior roof in the area of the cut was only dented approximately 1 inch, as shown in Figure 5.6. No other occupant compartment deformation or intrusion was noted. Tables A.3 and A.4 in Appendix A1 provide exterior crush and occupant compartment measurements.



Figure 5.5. Test Vehicle after Test No. 490026-2-1.



Figure 5.6. Interior of Test Vehicle after Test No. 490026-2-1.

5.2.7 Occupant Risk Factors

No accelerometer or other types of instrumentation were installed in the vehicle. *MASH* states that Test 3-72 “can be conducted without the instrumentation necessary for determining occupant risk whenever the test article has a total weight of 220 lb or less. In this

case, vehicle intrusion, windshield damage, and vehicle stability are the primary performance evaluation factors.” The weight of the temporary work zone sign support system was 60 lb.

5.2.8 Assessment of Test Results

An assessment of the test based on the applicable *MASH* safety evaluation criteria for *MASH* test 3-72 is provided below.

5.2.8.1 Structural Adequacy

- B. *The test article should readily activate in a predictable manner by breaking away, fracturing, or yielding.*

Results: The Option A temporary work zone sign support readily activated by yielding to the 2270P vehicle and fracturing. (PASS)

5.2.8.2 Occupant Risk

- D. *Detached elements, fragments, or other debris from the test article should not penetrate or show potential for penetrating the occupant compartment, or present an undue hazard to other traffic, pedestrians, or personnel in a work zone.*

Deformation of, or intrusions into, the occupant compartment should not exceed limits set forth in Section 5.3 and Appendix E of MASH (roof ≤ 4.0 inches; windshield = ≤ 3.0 inches; side windows = no shattering by test article structural member; wheel/foot well/toe pan ≤ 9.0 inches; forward of A-pillar ≤ 12.0 inches; front side door area above seat ≤ 9.0 inches; front side door below seat ≤ 12.0 inches; floor pan/transmission tunnel area ≤ 12.0 inches).

Results: The Option A temporary work zone sign support released and fractured into three pieces. The sign panel and the attached upper section of the vertical support post contacted the roof of the 2270P vehicle causing a 16-inch long scratch that ended in a 5-inch long tear on the outer surface of the roof at the rear of the cab. This was determined to be of concern for potential intrusion into the vehicle. (FAIL)

The 5-inch cut did not penetrate the occupant compartment, but the interior section of the roof was dented inward approximately 1 inch at this location. No other occupant compartment deformation or intrusion was noted. (PASS)

- E. *Detached element, fragments or other debris from the test article, or vehicular damage should not block the driver’s vision or otherwise cause the driver to lose control of the vehicle.*

Results: The released and fractured pieces of the Option A temporary work zone sign support did not block the driver's view and would not cause the driver to lose control of the 2270P vehicle. (PASS)

F. *The vehicle should remain upright during and after collision. The maximum roll and pitch angles are not to exceed 75 degrees.*

Results: The 2270P vehicle remained upright during and after the collision event. (PASS)

H. *Occupant impact velocities should satisfy the following:*

Longitudinal and Lateral Occupant Impact Velocity

<u><i>Preferred</i></u>	<u><i>Maximum</i></u>
<i>10 ft/s</i>	<i>16.4 ft/s</i>

Results: Assessment of occupant risk factors is not required for test articles having a total weight of 220 lb or less. (NA)

I. *Occupant ridedown accelerations should satisfy the following:*

Longitudinal and Lateral Occupant Ridedown Accelerations

<u><i>Preferred</i></u>	<u><i>Maximum</i></u>
<i>15 G</i>	<i>20.49 G</i>

Results: Assessment of occupant risk factors is not required for test articles having a total weight of 220 lb or less. (NA)

5.2.8.3 Vehicle Trajectory

N. *Vehicle trajectory behind the test article is acceptable.*

Results: The 2270P vehicle came to rest 280 ft behind the point of impact with the Option A temporary work zone sign support. (PASS)

5.2.9 Conclusions

Figure 5.7 provides a summary of the results of the test. The slip connection incorporated into the vertical support post of the Option A temporary work zone sign support allowed the top of the system to release from the lower section of the vertical support post and base as intended. The corner of the sign panel impacted the vehicle roof, and no tear occurred with this first impact. However, as the vehicle continued forward, the sign panel continued to rotate and impacted the rear of the roof causing a 5-inch long tear in the exterior of the roof. The tear did not extend into the occupant compartment, but did cause a 1-inch dent in the interior roof panel at this location of the right rear passenger compartment. Due to the extent of the external roof tear, the Option A temporary work zone sign support was judged to have potential for intrusion into the occupant compartment.

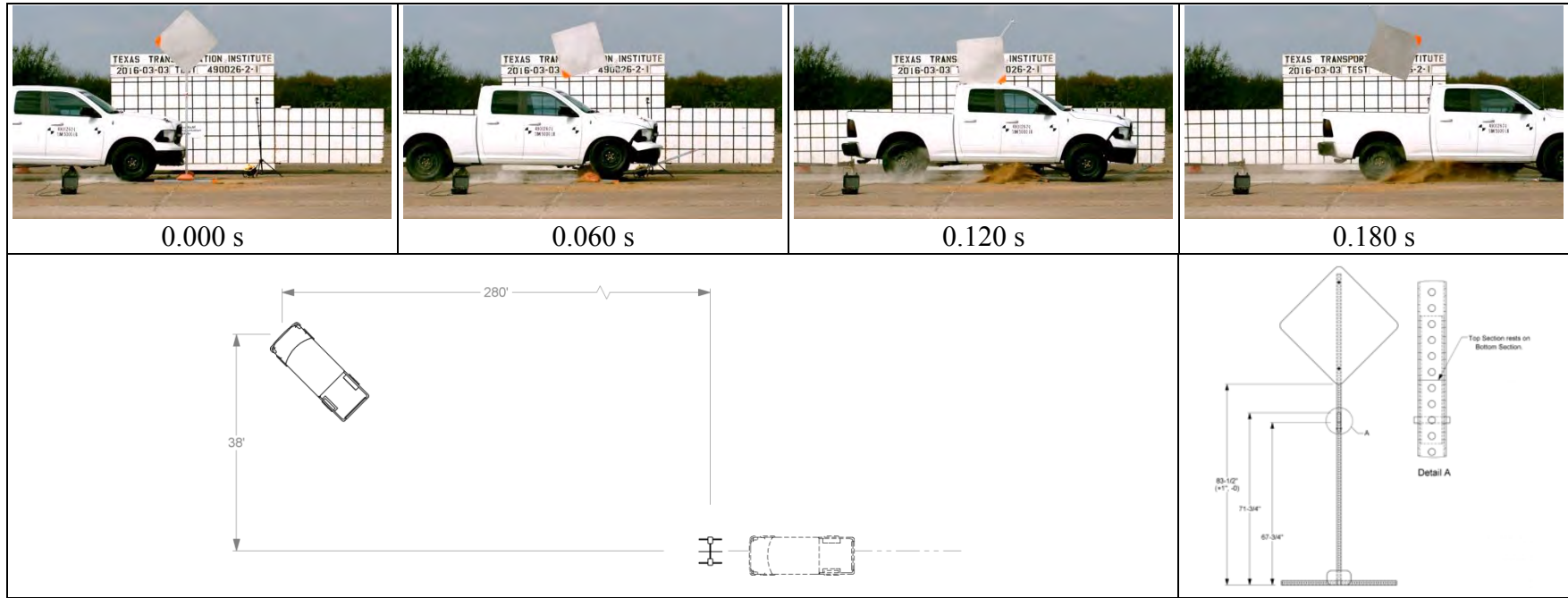

General Information

Test Agency Texas A&M Transportation Institute (TTI)
 Test Standard Test No. MASH Test 3-72
 TTI Test No. 490026-2-1
 Test Date 2016-03-03

Test Article

Type Temporary Work Zone Sign Support
 Name Option A Temporary Work Zone Sign Support
 Installation Height 83½ inches to bottom of sign; 132 5/8 to top
 Material or Key Elements Upper & lower sections connected with 8-inch long insert sleeve of 1½-inch, 12-gauge perforated square steel tubing secured with 5/8-inch diameter x 2½-inch long smooth pin located in holes 2½ inches below joint

Soil Type and Condition Placed on dry concrete surface

Test Vehicle

Type/Designation 2270P
 Make and Model 2010 Dodge Ram 1500
 Curb 4898 lb
 Test Inertial 5014 lb
 Dummy No dummy
 Gross Static 5014 lb

Impact Conditions

Speed 62.9 mi/h
 Angle 90 degrees
 Location/Orientation 10 inches right of centerline

Kinetic Energy 663 kip-ft

Exit Conditions

Speed 61.8 mi/h
 Angle NA

Occupant Risk Values Assessment of occupant risk factors not required for test articles of 60 lb

Test Article Debris Scatter

Longitudinal 98 ft downstream
 Lateral 12 ft left of center

Post-Impact Trajectory

Stopping Distance 280 ft downstream
 38 ft right of center

Vehicle Stability

Maximum Yaw Angle Vehicle
 Maximum Pitch Angle remained
 Maximum Roll Angle upright
 Vehicle Snagging No
 Vehicle Pocketing No

Vehicle Damage

VDS 12FR1
 CDC 12FREN1
 Max. Exterior Deformation 2.5 inches
 OCDI RR0000000
 Max. Occupant Compartment Deformation 1 inch

Figure 5.7. Summary of Results for MASH Test 3-72 at 90 Degrees on the Option A Temporary Work Zone Sign Support.

Chapter 6. OPTION B TEMPORARY WORK ZONE SIGN SUPPORT

6.1 OPTION B DESIGN AND CONSTRUCTION

The Option B test installations were each fabricated with a single aluminum sign mounted on a 3-piece vertical support post fabricated from 1 $\frac{3}{4}$ -inch and 1 $\frac{1}{2}$ -inch, 12-gauge (0.105 inch) nominal thickness perforated square steel tubing containing $\frac{7}{16}$ -inch diameter holes on 1-inch spacing on all four sides. The sign panel measured 36 inches square and was fabricated from 0.100-inch thick aluminum. The sign was mounted in a diamond configuration with a tip-to-tip distance of 49 $\frac{1}{8}$ inches as a result of each corner having a 2-inch radius. The vertical support post and sign were mounted to an H-shaped base measuring 48 inches \times 51 $\frac{1}{2}$ inches comprised of three 48-inch long sections of 1 $\frac{3}{4}$ -inch perforated square steel tubing. Junctions of the 3-piece base and the lower section of the vertical support post were joined with fillet welds. The sign was attached to the uppermost section of the vertical support post with two $\frac{3}{8}$ -inch diameter \times 2 $\frac{1}{2}$ -inch long SAE grade 5 hex bolts, nuts, and flat and lock washers. Two 40-lb sandbags were placed on top of the H-shaped base; one at the midpoint of each outrigger. The approximate total weight of each test assembly was 58 lb (16-lb sign panel, 18-lb sectional vertical support post, and 24-lb 3-piece base) exclusive of two 40 lb sandbags).

For Option B, the vertical support post was comprised of three sections. The middle and upper sections of the vertical support post were fabricated from 1 $\frac{1}{2}$ -inch, 12-gauge (0.105 inch) nominal thickness perforated square steel tubing. The 39-inch long top section and 26-inch long middle section were joined with two opposing fuse plates, each 1 $\frac{1}{2}$ inch wide \times 8 $\frac{1}{2}$ inches long \times $\frac{1}{8}$ inch thick. The fuse plates had four $\frac{7}{16}$ -inch diameter holes located to match hole locations in the perforated square steel tubing, and one centrally located 1-inch diameter weakening hole. These fuse plates joined the upper and middle vertical support post sections using four $\frac{3}{8}$ -inch diameter \times 2 $\frac{1}{2}$ -inch long hex bolts, lock washers, and nuts. The lower end of the assembled middle section of the vertical support post was inserted approximately 4 $\frac{9}{32}$ inches into the 64-inch long, 1 $\frac{3}{4}$ -inch square bottom section of the vertical support post and rested on a $\frac{3}{8}$ -inch diameter \times 2 $\frac{1}{2}$ -inch long hex bolt (with nut) located in the holes 4 $\frac{1}{2}$ inches below the upper edge of the bottom section. The head of the bolt was welded in place and the nut was snugly tightened. The top of the lower joint in the vertical support post was 65 $\frac{3}{4}$ inches above grade. The bottom and top corners of the sign panel were 83 $\frac{1}{2}$ inches and 132 $\frac{5}{8}$ inches above grade, respectively. The installation was oriented to impact the sign from the reverse direction during the zero degree impacts.

Figure 6.1 shows details of the Option B sign support installation. Figure 6.2 provides photographs of the completed installation.

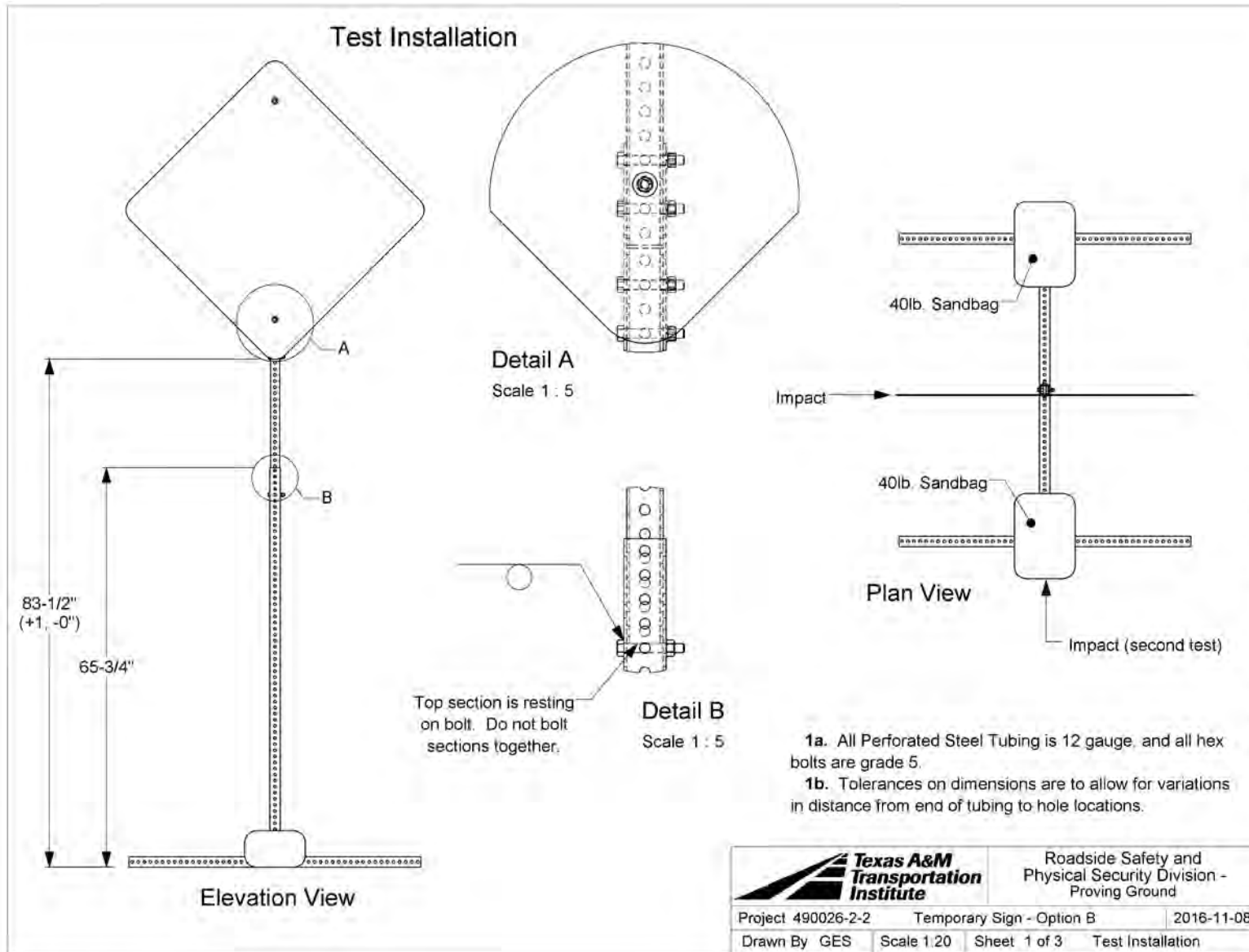

T:\1-ProjectFiles\490026-Tx\DOT\2 - Temporary Single Leg Sign Support - Chiara\2-2\Drafting\490026-2-2 Drawing

Figure 6.1. Details of the Option B Temporary Work Zone Sign Support.

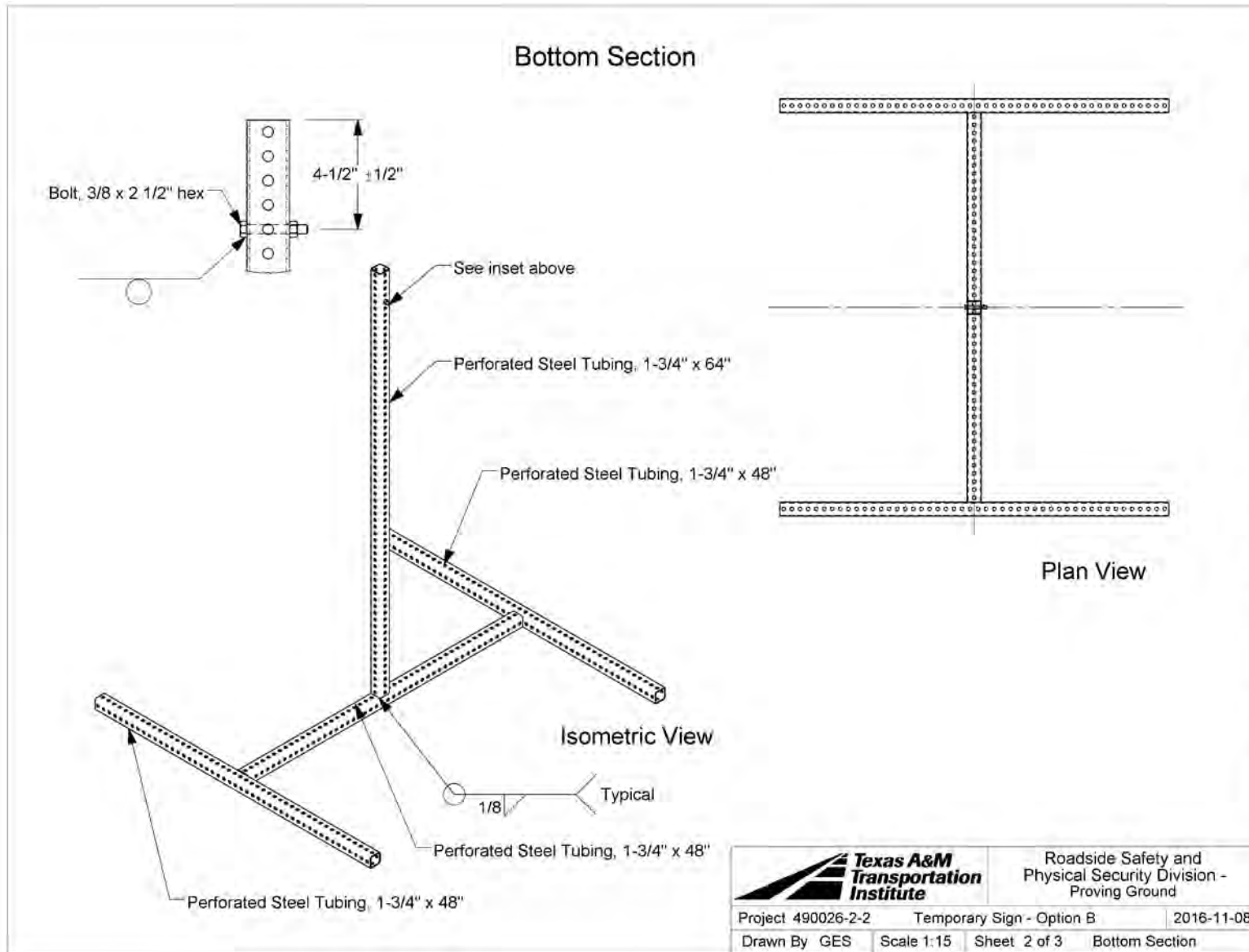

T:\1-ProjectFiles\490026-Tx\DOT\2 - Temporary Single Leg Sign Support - Chiaro\2-2\Drafting\490026-2-2 Drawing

Figure 6.1. Details of the Option B Temporary Work Zone Sign Support (Continued).

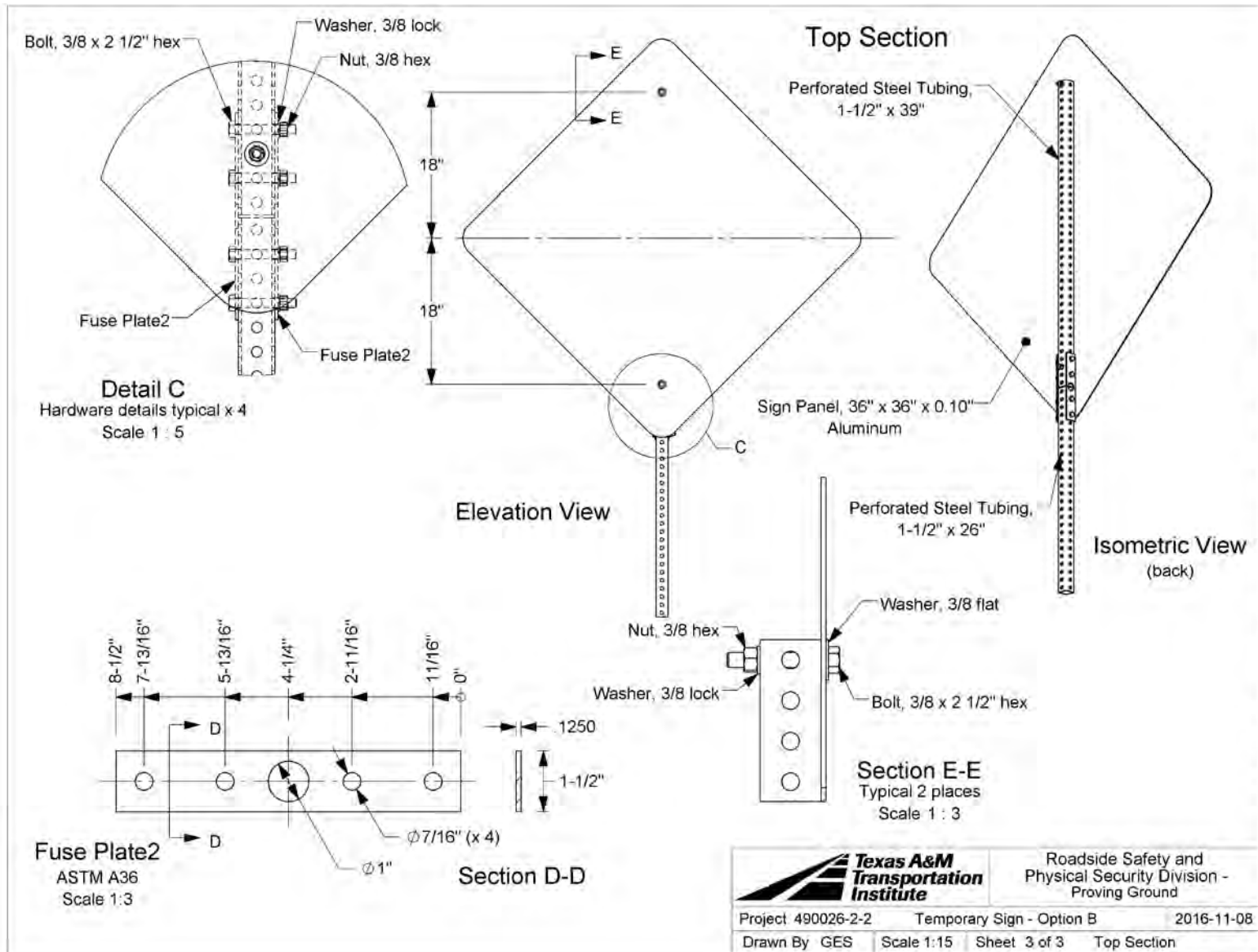

T:\11-ProjectFiles\490026-TxDOT\1-2 - Temporary Sign - Option B - Chihara\2-2\Drafting\490026-2-2 Drawing

Figure 6.1. Details of the Option B Temporary Work Zone Sign Support (Continued).

6.2 MASH TEST 3-72 AT 90 DEGREES (CRASH TEST NO. 490026-2-2)

6.2.1 Test Designation and Actual Impact Conditions

MASH Test 3-72 involves a 2270P vehicle weighing 5000 lb \pm 110 lb impacting the Option B temporary work zone sign support at an impact speed of 62.2 mi/h \pm 2.5 mi/h and CIA \pm 1.5 degrees. The CIA for MASH Test 3-72 on the temporary work zone sign support was 90 degrees. The 2010 Dodge Ram 1500 pickup truck used in the test weighed 5014 lb, and the actual impact speed and angle were 62.6 mi/h and 90 degrees, respectively. The actual impact point was 10 inches to the left of centerline of the vehicle. Target KE was \geq 594 kip-ft, and actual KE was 655 kip-ft.

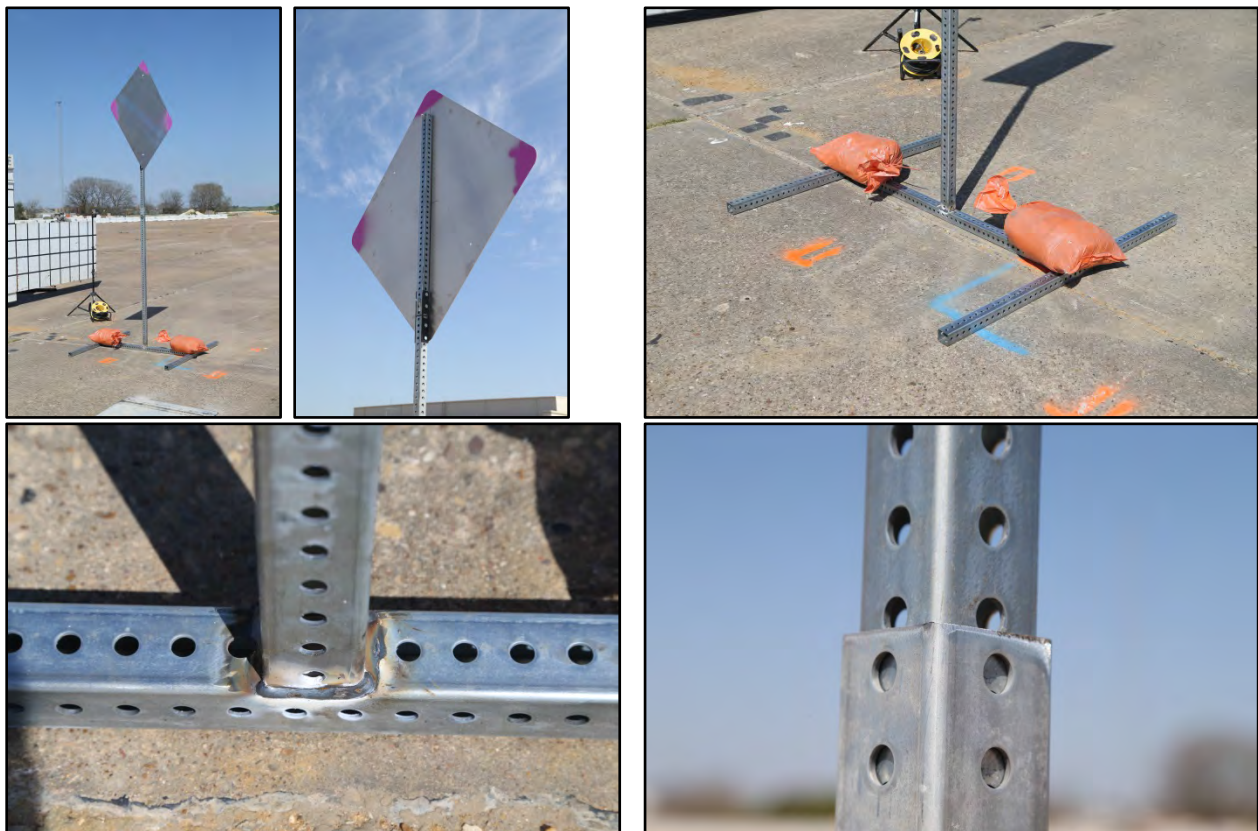

Figure 6.2. Option B Temporary Work Zone Sign Support Used for Test No. 490026-2-2.

6.2.2 Weather Conditions

The test was performed in the late morning of March 3, 2016. Weather conditions at the time of testing were as follows: wind speed: 12 mi/h; wind direction: 360 degrees with respect to the vehicle (vehicle was traveling in a northerly direction); temperature: 79°F; relative humidity: 53 percent.

6.2.3 Test Vehicle

The 2010 Dodge Ram 1500 pickup, shown in Figure 6.3, was used for the crash test. The vehicle's test inertia weight was 5014 lb, and its gross static weight was 5014 lb. The height to the lower edge of the vehicle bumper was 12.5 inches, and the height to the upper edge of the bumper was 27.5 inches. The height to the vehicle's center of gravity was 28.4 inches. Tables B.1 and B.2 in Appendix B1 give additional dimensions and information on the vehicle. The vehicle was directed into the installation using a cable reverse tow and guidance system, and was released to be freewheeling and unrestrained just prior to impact.



Figure 6.3. Test Vehicle before Test No. 490026-2-2.

6.2.4 Test Description

The 2010 Dodge Ram 1500 pickup, traveling at an impact speed of 62.6 mi/h, contacted the Option B temporary work zone sign support 10 inches to the left of centerline of the vehicle at an impact angle of 90 degrees. At 0.004 s after impact, the support contacted the upper grill, and at 0.005 s, the upstream end of the base began to lift off the concrete pavement. The middle section of the vertical support began to pull out of the lower section of the support at 0.007 s, and the lower section of the support began to deform at bumper height at 0.009 s. At 0.018 s, the middle and upper section of the support lost contact with the lower section, and at 0.085 s, the lower section of the support contacted the pavement. The sign panel and upper section of the support was parallel with and above the roof of the vehicle at 0.094 s, and the sign panel contacted the roof 50 inches behind the windshield at 0.114 s. At 0.133 s, the sign panel lost contact with the roof and the vehicle was traveling at a speed of 61.6 mi/h. Brakes on the vehicle were applied after loss of contact with the sign panel, and the vehicle came to rest 305 ft downstream of the impact point and 13 ft to the left of the vehicle impact path. Figure B.1 in Appendix B2 presents sequential photographs during the test.

6.2.5 Damage to Test Installation

Figure 6.4 shows the damage to the Option B temporary work zone sign support. The sign panel and middle and upper sections of the vertical support came to rest 10 ft downstream of impact and 2 ft to the left of centerline of the impact path. The fuse plates connecting the middle and upper sections of the vertical support were activated. The bottom section of the vertical

support fractured 24 inches above grade and the piece came to rest 77 ft downstream of impact and 3 ft to the right of centerline of the impact path. The H-shaped base and lower portion of the bottom section of the vertical support came to rest 108 ft downstream of impact and 6 ft right of centerline of the impact path.

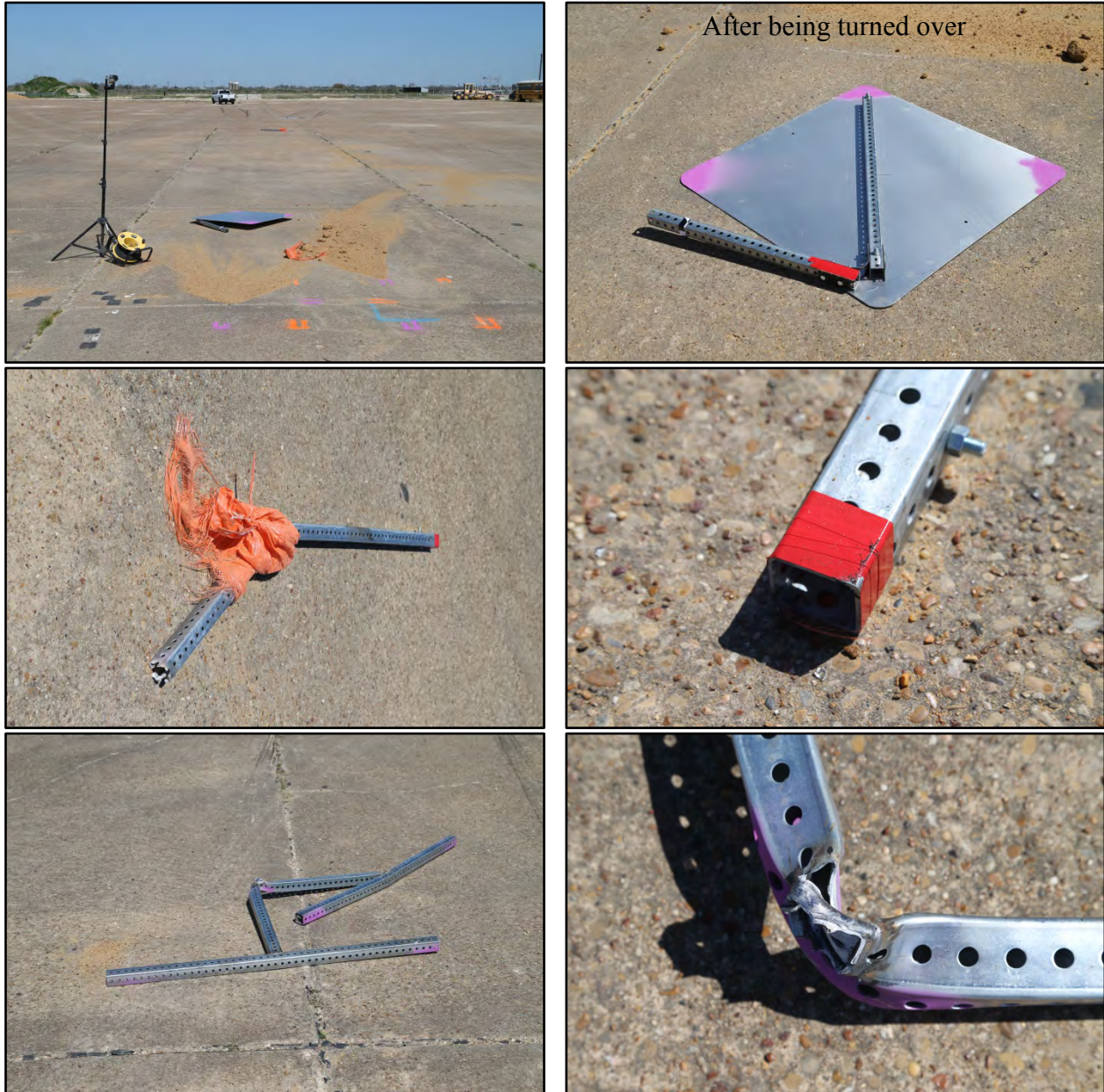

Figure 6.4. Option B Temporary Work Zone Sign Support after Test No. 490026-2-2.

6.2.6 Vehicle Damage

Figure 6.5 shows the damage sustained by the vehicle. The bumper and roof were scraped. A small tear in the transmission pan was noted, but did not show evidence of penetration or intrusion. Maximum exterior crush to the vehicle was 2.5 inches in the front plane

at the left quarter point at bumper height. On the left side of the roof of the cab, there was a 10-inch long dent on the outer surface, but no penetration into the passenger compartment. Figure 6.6 shows the interior of the vehicle. No occupant compartment deformation or intrusion was noted. Tables B.3 and B.4 in Appendix B1 provide exterior crush and occupant compartment measurements.



Figure 6.5. Test Vehicle after Test No. 490026-2-2.

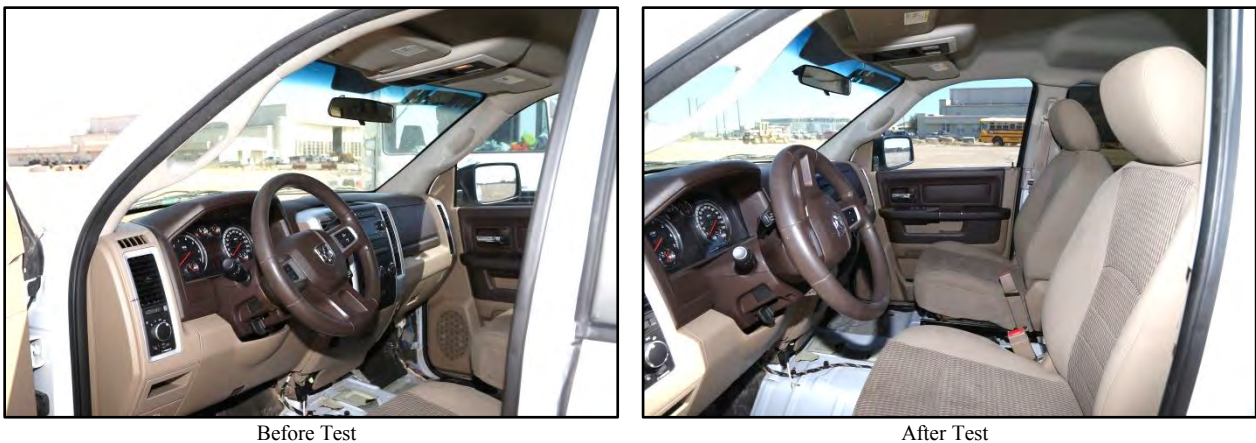

Figure 6.6. Interior of Test Vehicle for Test No. 490026-2-2.

6.2.7 Occupant Risk Factors

No accelerometer or other types of instrumentation were installed in the vehicle. *MASH* states that Test 3-72 “can be conducted without the instrumentation necessary for determining occupant risk whenever the test article has a total weight of 220 lb or less. In this case, vehicle intrusion, windshield damage, and vehicle stability are the primary performance evaluation factors.” The weight of the temporary work zone sign support system was 58 lb.

6.2.8 Assessment of Test Results

An assessment of the test based on the applicable *MASH* safety evaluation criteria for *MASH* test 3-72 is provided below.

6.2.8.1 Structural Adequacy

- B. *The test article should readily activate in a predictable manner by breaking away, fracturing, or yielding.*

Results: The Option B temporary work zone sign support readily activated by yielding to the 2270P vehicle and fracturing. (PASS)

6.2.8.2 Occupant Risk

- D. *Detached elements, fragments, or other debris from the test article should not penetrate or show potential for penetrating the occupant compartment, or present an undue hazard to other traffic, pedestrians, or personnel in a work zone.*

Deformation of, or intrusions into, the occupant compartment should not exceed limits set forth in Section 5.3 and Appendix E of MASH (roof ≤ 4.0 inches; windshield = ≤ 3.0 inches; side windows = no shattering by test article structural member; wheel/foot well/toe pan ≤ 9.0 inches; forward of A-pillar ≤ 12.0 inches; front side door area above seat ≤ 9.0 inches; front side door below seat ≤ 12.0 inches; floor pan/transmission tunnel area ≤ 12.0 inches).

Results: The Option B temporary work zone sign support released and fractured into three pieces; however, there was no concern for potential deformation or intrusion into the vehicle. (PASS)

No occupant compartment penetration, deformation, or intrusion was noted. (PASS)

- E. *Detached element, fragments or other debris from the test article, or vehicular damage should not block the driver’s vision or otherwise cause the driver to lose control of the vehicle.*

Results: The released and fractured pieces of the Option B temporary work zone sign support did not block the driver’s view or otherwise cause the driver to lose control of the 2270P vehicle. (PASS)

F. *The vehicle should remain upright during and after collision. The maximum roll and pitch angles are not to exceed 75 degrees.*

Results: The 2270P vehicle remained upright during and after the collision event. (PASS)

H. *Occupant impact velocities should satisfy the following:*

Longitudinal and Lateral Occupant Impact Velocity

<u>Preferred</u>	<u>Maximum</u>
10 ft/s	16.4 ft/s

Results: Assessment of occupant risk factors is not required for test articles having a total weight of 220 lb or less. (NA)

I. *Occupant ridedown accelerations should satisfy the following:*

Longitudinal and Lateral Occupant Ridedown Accelerations

<u>Preferred</u>	<u>Maximum</u>
15 G	20.49 G

Results: Assessment of occupant risk factors is not required for test articles having a total weight of 220 lb or less. (NA)

6.2.8.3 Vehicle Trajectory

N. *Vehicle trajectory behind the test article is acceptable.*

Results: The 2270P vehicle came to rest 305 ft behind the Option B temporary work zone sign support. (PASS)

6.2.9 Conclusions

Figure 6.7 provides a summary of the results of the test. The slip connection between the bottom and middle sections of the vertical support performed as designed and released the middle and upper sections and sign panel from the lower section and base. The fuse plate between the upper and middle sections of the vertical support activated as designed. Although the sign panel impacted the roof, this contact did not result in any tear or penetration of the roof. The slight roof deformation that occurred was within *MASH* criteria.

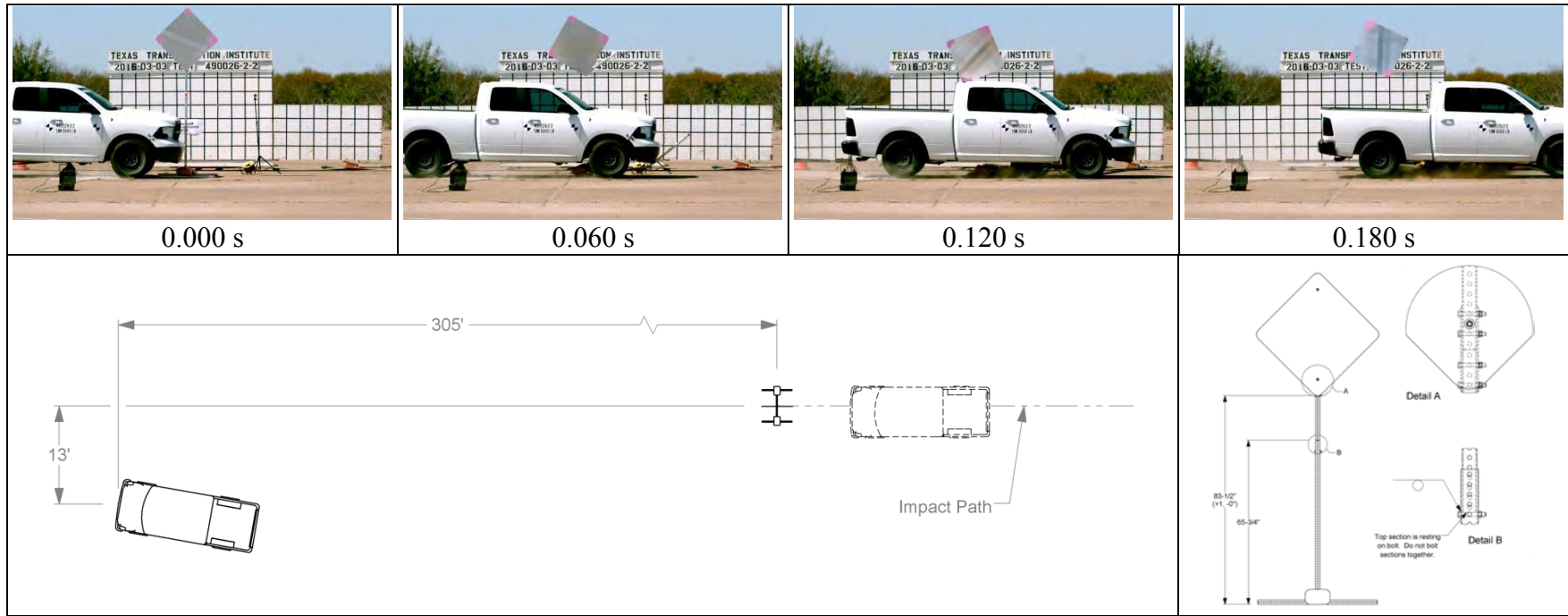

General Information

Test Agency Texas A&M Transportation Institute (TTI)
 Test Standard Test No. MASH Test 3-72
 TTI Test No. 490026-2-2
 Test Date 2016-03-03

Test Article

Type Temporary Work Zone Sign Support
 Name Option B Temporary Work Zone Sign Support
 Installation Height 83½ inches to bottom of sign; 132% to top
 Material or Key Elements Upper & middle sections joined with two opposing fuse plates; smaller 1½ inch middle section had telescopic slip joint inside 1 ¾ inch lower section of vertical support

Soil Type and Condition Placed on dry concrete surface

Test Vehicle

Type/Designation 2270P
 Make and Model 2010 Dodge Ram 1500
 Curb 4898 lb
 Test Inertial 5014 lb
 Dummy No dummy
 Gross Static 5014 lb

Impact Conditions

Speed 62.6 mi/h
 Angle 90 degrees
 Location/Orientation 10 inches left of centerline 655 kip-ft

Kinetic Energy 61.6 mi/h

Exit Conditions

Speed Assessment of
 Angle occupant risk factors not

Occupant Risk Values required for test articles of 58 lb

Test Article Debris Scatter

Longitudinal 108 downstream
 Lateral 2 ft left – 6 ft right

Post-Impact Trajectory

Stopping Distance 305 ft downstream
 13 ft left of center

Vehicle Stability

Maximum Yaw Angle Vehicle
 Maximum Pitch Angle remained
 Maximum Roll Angle upright
 Vehicle Snagging No
 Vehicle Pocketing No

Vehicle Damage

VDS 12FL1
 CDC 12FLEN1
 Max. Exterior Deformation 2.5 inches
 OCDI RR0000000
 Max. Occupant Compartment Deformation None

Figure 6.7. Summary of Results for MASH Test 3-72 at 90 Degrees on the Option B Temporary Work Zone Sign Support.

6.3 MASH TEST 3-71 AT 90 DEGREES (CRASH TEST NO. 490026-2-4)

6.3.1 Test Designation and Actual Impact Conditions

MASH Test 3-71 involves an 1100C vehicle weighing 2425 lb \pm 55 lb and impacting the Option B temporary work zone sign support at an impact speed of 62.2 mi/h \pm 2.5 mi/h and CIA \pm 1.5 degrees. The CIA for MASH Test 3-71 on the temporary work zone sign support was 90 degrees. The 2011 Kia Rio used in the test weighed 2443 lb, and the actual impact speed and angle were 60.9 mi/h and 90 degrees, respectively. The actual impact point was 10 inches right of the vehicle centerline. The target KE was \geq 288 kip-ft, and the actual KE at impact was 303 kip-ft. Figure 6.8 shows the installation before the test.

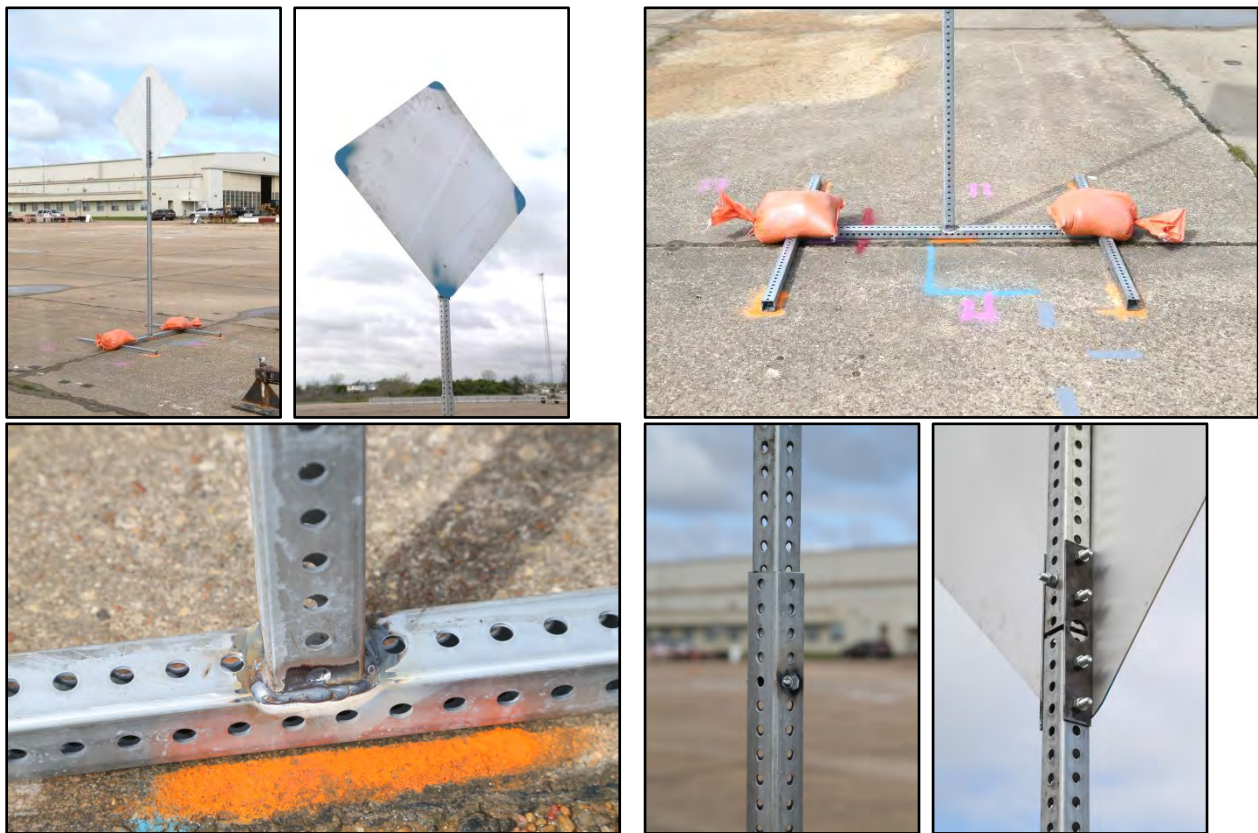

Figure 6.8. Option B Temporary Work Zone Sign Support Used for Test No. 490026-2-4.

6.3.2 Weather Conditions

The test was performed on the morning of March 11, 2016. Weather conditions at the time of testing were as follows: wind speed: 3 mi/h; wind direction: 205 degrees with respect to the vehicle (vehicle was traveling in a northerly direction); temperature: 66°F; relative humidity: 89 percent.

6.3.3 Test Vehicle

The 2011 Kia Rio, shown in Figure 6.9, was used for the crash test. The vehicle's test inertia weight was 2443 lb, and its gross static weight was 2608 lb. The height to the lower edge of the vehicle bumper was 8.0 inches, and the height to the upper edge of the vehicle bumper was 21.5 inches. Table C.1 in Appendix C1 gives additional dimensions and information on the vehicle. The vehicle was directed into the installation using a cable reverse tow and guidance system, and was released to be freewheeling and unrestrained just prior to impact.



Figure 6.9. Test Vehicle before Test No. 490026-2-4.

6.3.4 Test Description

The 2011 Kia Rio, traveling at an impact speed of 60.9 mi/h, contacted the Option B temporary work zone sign support 10 inches to the right of centerline of the vehicle at an impact angle of 90 degrees. At 0.003 s after impact, the base of the support began to lift off the concrete pavement, and at 0.007 s, the middle section of the support began to release from the lower section at the slip joint. The middle and upper sections of the support lost contact with the lower section at 0.024 s, and the vehicle lost contact with the support at 0.140 s traveling at a speed of 58.8 mi/h. Brakes on the vehicle were applied after loss of contact with the support, and the vehicle came to rest 468 ft downstream of impact. Figure C.1 in Appendix C2 presents sequential photographs during the test.

6.3.5 Damage to Test Installation

Figure 6.10 shows the damage to the Option B temporary work zone sign support. The sign panel and middle and upper sections of the vertical support came to rest 3 ft downstream of impact and on the centerline of the impact path. The fuse plates connecting the middle and upper section of the support were activated. The remainder of the temporary work zone sign support rode along with the 1100C vehicle. As the vehicle came to a stop, the support slid ahead of the vehicle and came to rest 483 ft downstream of impact and on the centerline of the impact path. The lower section of the vertical support was bent at bumper height.



Figure 6.10. Option B Temporary Work Zone Sign Support after Test No. 490026-2-4.

6.3.6 Vehicle Damage

Figure 6.11 shows the damage sustained by the vehicle. The 1100C vehicle sustained only scrapes to the bumper and hood with no measureable exterior vehicle deformation. Figure 6.12 shows the interior of the vehicle. No occupant compartment deformation or intrusion was noted. Tables C.2 and C.3 in Appendix C1 provide exterior crush and occupant compartment measurements.



Figure 6.11. Test Vehicle after Test No. 490026-2-4.



Figure 6.12. Interior of Test Vehicle for Test No. 490026-2-4.

6.3.7 Occupant Risk Factors

No accelerometer or other types of instrumentation were installed in the vehicle. *MASH* states that Test 3-72 “can be conducted without the instrumentation necessary for determining occupant risk whenever the test article has a total weight of 220 lb or less. In this

case, vehicle intrusion, windshield damage, and vehicle stability are the primary performance evaluation factors.” The weight of the temporary work zone sign support system was 58 lb.

6.3.8 Assessment of Test Results

An assessment of the test based on the applicable *MASH* safety evaluation criteria for *MASH* test 3-71 is provided below.

6.3.8.1 Structural Adequacy

- B. The test article should readily activate in a predictable manner by breaking away, fracturing, or yielding.*

Results: The Option B temporary work zone sign support readily activated by yielding to the 1100C vehicle and releasing at a slip joint as designed. (PASS)

6.3.8.2 Occupant Risk

- D. Detached elements, fragments, or other debris from the test article should not penetrate or show potential for penetrating the occupant compartment, or present an undue hazard to other traffic, pedestrians, or personnel in a work zone.*

Deformation of, or intrusions into, the occupant compartment should not exceed limits set forth in Section 5.3 and Appendix E of MASH (roof ≤ 4.0 inches; windshield = ≤ 3.0 inches; side windows = no shattering by test article structural member; wheel/foot well/toe pan ≤ 9.0 inches; forward of A-pillar ≤ 12.0 inches; front side door area above seat ≤ 9.0 inches; front side door below seat ≤ 12.0 inches; floor pan/transmission tunnel area ≤ 12.0 inches).

Results: The Option B temporary work zone sign support released into two pieces; however, there was no potential for penetration into the vehicle. The lower portion of the sign support rode along with the 1100C vehicle and came to rest 15 ft ahead of the vehicle. (PASS)
No occupant compartment deformation or intrusion was noted. (PASS)

- E. Detached element, fragments or other debris from the test article, or vehicular damage should not block the driver’s vision or otherwise cause the driver to lose control of the vehicle.*

Results: The released pieces of the Option B temporary work zone sign support did not block the driver’s view and would not cause the driver to lose control of the 1100C vehicle. (PASS)

- F. The vehicle should remain upright during and after collision. The maximum roll and pitch angles are not to exceed 75 degrees.*

Results: The 1100C vehicle remained upright during and after the collision event. (PASS)

H. *Occupant impact velocities should satisfy the following:*

Longitudinal and Lateral Occupant Impact Velocity

<u><i>Preferred</i></u>	<u><i>Maximum</i></u>
<i>10 ft/s</i>	<i>16.4 ft/s</i>

Results: Assessment of occupant risk factors is not required for test articles having a total weight of 220 lb or less. (NA)

I. *Occupant ridedown accelerations should satisfy the following:*

Longitudinal and Lateral Occupant Ridedown Accelerations

<u><i>Preferred</i></u>	<u><i>Maximum</i></u>
<i>15 G</i>	<i>20.49 G</i>

Results: Assessment of occupant risk factors is not required for test articles having a total weight of 220 lb or less. (NA)

6.3.8.3 Vehicle Trajectory

N. *Vehicle trajectory behind the test article is acceptable.*

Results: The 1100C vehicle came to rest 468 ft behind the Option B temporary work zone sign support. (PASS)

6.3.9 Conclusions

Figure 6.13 provides a summary of the results of the test. The slip connection between the bottom and middle sections of the vertical support performed as designed and released the middle and upper sections and sign panel from the lower section and base. The fuse plate between the upper and middle sections of the vertical support activated as designed. There was no secondary contact between the sign panel and the roof of the vehicle.

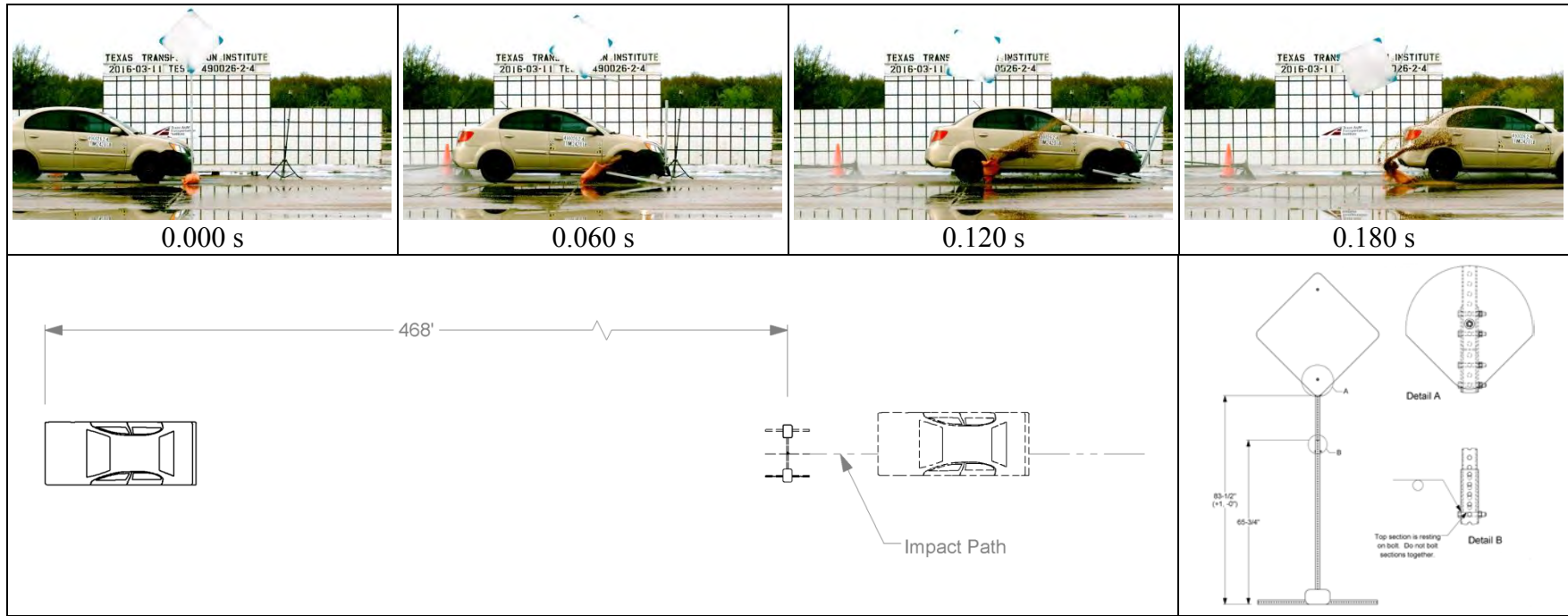

General Information

Test Agency Texas A&M Transportation Institute (TTI)
 Test Standard Test No. MASH Test 3-71
 TTI Test No. 490026-2-4
 Test Date 2016-03-11

Test Article

Type Temporary Work Zone Sign Support
 Name Option B Temporary Work Zone Sign Support
 Installation Height 83½ inches to bottom; 132¾ to top
 Material or Key Elements Upper & lower sections joined with two opposing fuse plates, Upper & middle sections joined with two opposing fuse plates; smaller 1½ inch middle section had telescopic slip joint inside 1 ¾ inch lower section of vertical support

Soil Type and Condition Placed on dry concrete surface

Test Vehicle

Type/Designation 1100C
 Make and Model 2011 Kia Rio
 Curb 2479 lb
 Test Inertial 2443 lb
 Dummy 165 lb
 Gross Static 2608 lb

Impact Conditions

Speed 60.9 mi/h
 Angle 90 degrees
 Location/Orientation 10 inches right of centerline 303 kip-ft

Kinetic Energy 58.8 mi/h

Exit Conditions NA

Speed Assessment of occupant
 Angle risk factors not required

Occupant Risk Values for test articles of 58 lb

Test Article Debris Scatter

Longitudinal 483 downstream
 Lateral Centerline

Post-Impact Trajectory

Stopping Distance 468 ft downstream
 Centerline

Vehicle Stability

Maximum Yaw Angle Vehicle
 Maximum Pitch Angle remained
 Maximum Roll Angle upright
 Vehicle Snagging No
 Vehicle Pocketing No

Vehicle Damage

VDS 12FR1
 CDC 12FREN1
 Max. Exterior Deformation None
 OCDI RF0000000
 Max. Occupant Compartment Deformation None

Figure 6.13. Summary of Results for MASH Test 3-71 at 90 Degrees on the Option B Temporary Work Zone Sign Support.

6.4 MASH TEST 3-71 AT 0 DEGREES (CRASH TEST NO. 490026-2-6)

6.4.1 Test Designation and Actual Impact Conditions

MASH Test 3-71 involves a 1100C vehicle weighing 2425 lb \pm 55 lb and impacting the Option B temporary work zone sign support 10 inches to the right of centerline of the vehicle at an impact speed of 62.2 mi/h \pm 2.5 mi/h and CIA \pm 1.5 degrees. The CIA for MASH Test 3-71 on the temporary work zone sign support was 0 degrees. The 2011 Kia Rio used in the test weighed 2443 lb, and the actual impact speed and angle were 61.7 mi/h and 0 degrees, respectively. The actual impact point was the right quarter point of the front of the vehicle. The target KE was \geq 288 kip-ft, and the actual KE at impact was 311 kip-ft. Figure 6.14 shows the installation before the test.



Figure 6.14. Option B Temporary Work Zone Sign Support Used for Test No. 490026-2-6.

6.4.2 Weather Conditions

The test was performed on the afternoon of March 11, 2016. Weather conditions at the time of testing were as follows: wind speed: 4 mi/h; wind direction: 146 degrees with respect to the vehicle (vehicle was traveling in a northerly direction); temperature: 72°F; relative humidity: 73 percent.

6.4.3 Test Vehicle

The 2011 Kia Rio used in the previous test 490026-2-4, shown in Figure 6.15, was used for the crash test. The vehicle's test inertia weight was 2443 lb, and its gross static weight was 2608 lb. The height to the lower edge of the vehicle bumper was 8.0 inches, and the height to the upper edge of the vehicle bumper was 21.5 inches. Table D.1 in Appendix D1 gives additional dimensions and information on the vehicle. The vehicle was directed into the installation using a cable reverse tow and guidance system, and was released to be freewheeling and unrestrained just prior to impact.



Figure 6.15. Test Vehicle before Test No. 490026-2-6.

6.4.4 Test Description

The 2011 Kia Rio, traveling at an impact speed of 61.7 mi/h, contacted the Option B temporary work zone sign support 10 inches to the right of centerline of the vehicle at an impact angle of 0 degrees. At 0.001 s after impact, the right front tire contacted the base of the support, and at 0.003 s, the base began to lift off the concrete pavement. The upper section of the support began to release from the lower section at 0.006 s, and the lower section of the support fractured at bumper height at 0.010 s. At 0.017 s, the upper section of the support lost contact with the lower section, and the lower section lost contact with the bumper at 0.055 s. The top of the lower section of the support contacted the concrete pavement at 0.086 s, and the vehicle contacted the lower section of the support again at 0.172 s. The vehicle was traveling at a speed of 59.7 mi/h. Brakes on the vehicle were applied after loss of contact with the support, and the vehicle came to rest 438 ft downstream of impact. Figure D.1 in Appendix D2 presents sequential photographs during the test.

6.4.5 Damage to Test Installation

Figure 6.16 shows the damage to the Option B temporary work zone sign support. The sign panel and the attached upper and middle sections of the vertical support came to rest 3 ft downstream of impact. The lower section of the vertical support fractured into two pieces 16 inches above ground level. The upper fractured piece came to rest 185 ft downstream of impact and 12 ft to the right of centerline of the vehicle path. The remaining lower portion and H-base of the temporary work zone sign support came to rest 83 ft downstream of impact.

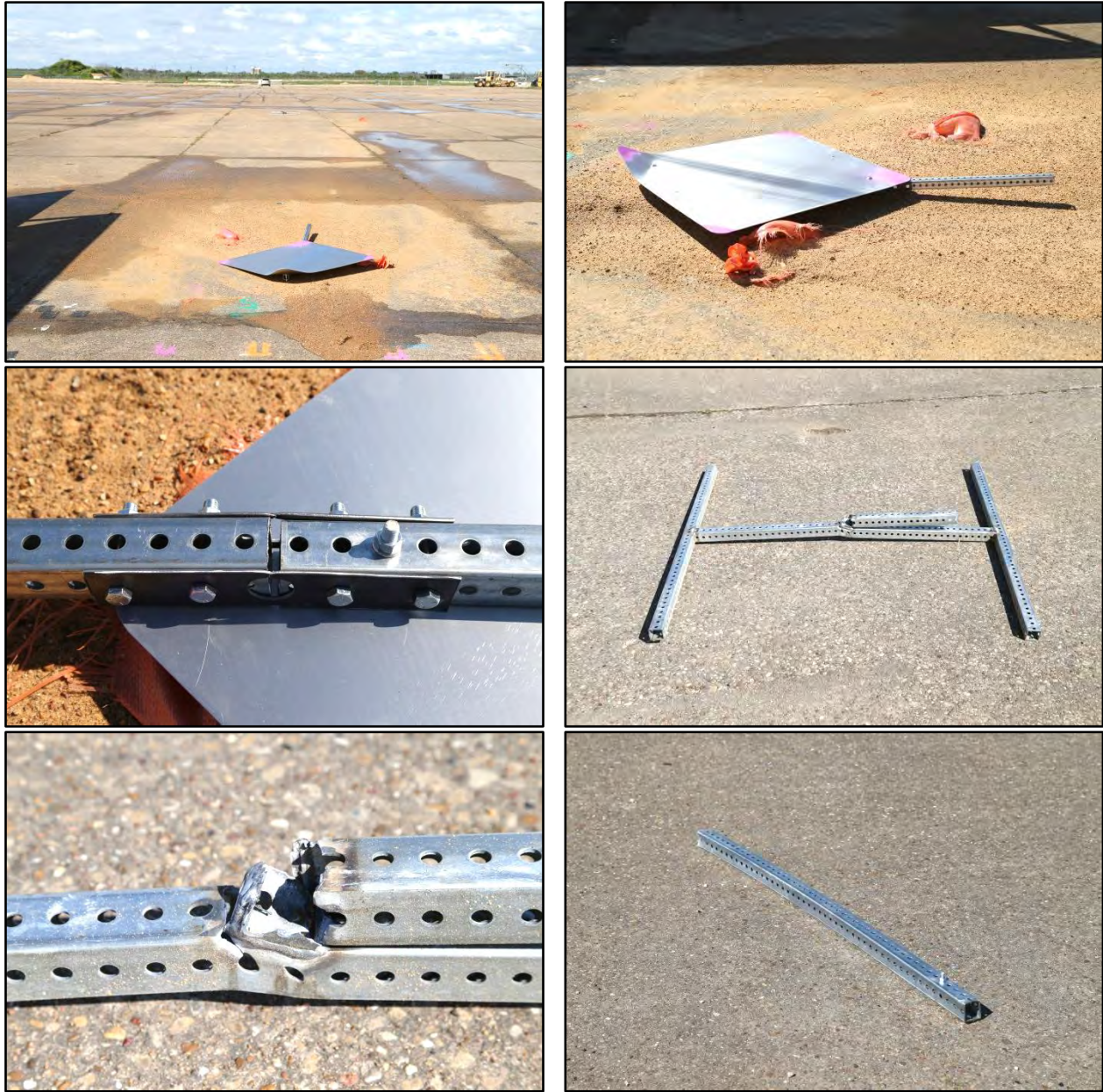

Figure 6.16. Option B Temporary Work Zone Sign Support after Test No. 490026-2-6.

6.4.6 Vehicle Damage

Figure 6.17 shows the damage sustained by the vehicle. The 1100C vehicle sustained only scrapes to the bumper and hood with no measureable exterior vehicle deformation. Figure 6.18 shows the interior of the vehicle. No occupant compartment penetration, deformation, or intrusion was noted. Tables D.2 and D.3 in Appendix D1 provide exterior crush and occupant compartment measurements.



Figure 6.17. Test Vehicle after Test No. 490026-2-6.

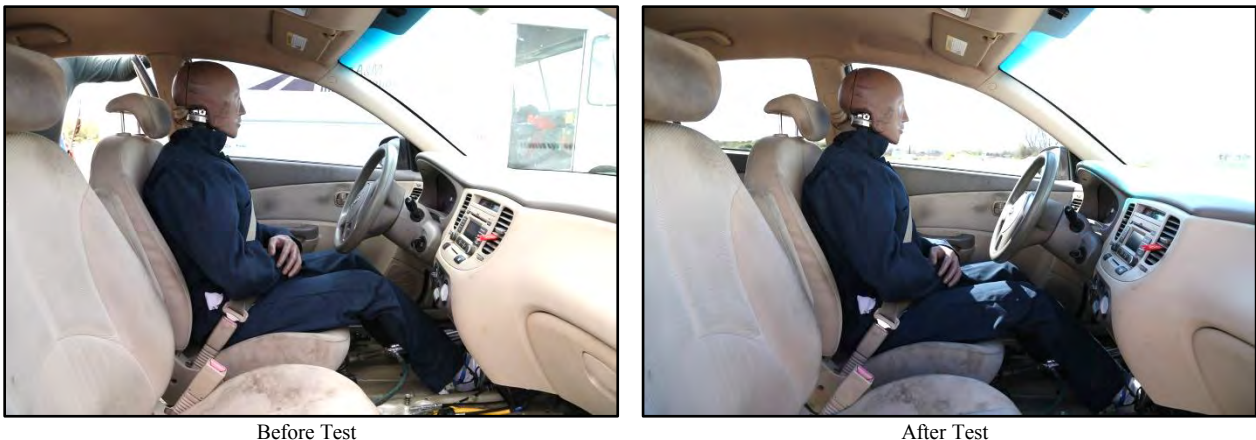

Figure 6.18. Interior of Test Vehicle for Test No. 490026-2-6.

6.4.7 Occupant Risk Factors

No accelerometer or other types of instrumentation were installed in the vehicle. *MASH* states that Test 3-71 “can be conducted without the instrumentation necessary for determining occupant risk whenever the test article has a total weight of 220 lb or less. In this

case, vehicle intrusion, windshield damage, and vehicle stability are the primary performance evaluation factors.” The weight of the temporary work zone sign support system was 58 lb.

6.4.8 Assessment of Test Results

An assessment of the test based on the applicable *MASH* safety evaluation criteria for *MASH* test 3-71 is provided below.

6.4.8.1 Structural Adequacy

- B. The test article should readily activate in a predictable manner by breaking away, fracturing, or yielding.*

Results: The Option B temporary work zone sign support readily activated by yielding to the 1100C vehicle, releasing at the slip joint, and fracturing. (PASS)

6.4.8.2 Occupant Risk

- D. Detached elements, fragments, or other debris from the test article should not penetrate or show potential for penetrating the occupant compartment, or present an undue hazard to other traffic, pedestrians, or personnel in a work zone.*

Deformation of, or intrusions into, the occupant compartment should not exceed limits set forth in Section 5.3 and Appendix E of MASH (roof ≤ 4.0 inches; windshield = ≤ 3.0 inches; side windows = no shattering by test article structural member; wheel/foot well/toe pan ≤ 9.0 inches; forward of A-pillar ≤ 12.0 inches; front side door area above seat ≤ 9.0 inches; front side door below seat ≤ 12.0 inches; floor pan/transmission tunnel area ≤ 12.0 inches).

Results: The Option B temporary work zone sign support released and fractured into three pieces; however, there was no concern for penetration or intrusion into the vehicle. The lower portion of the sign support rode along with the 1100C vehicle for a distance and came to rest 83 ft downstream of impact and along the centerline of the vehicle path. (PASS)

No occupant compartment deformation or intrusion was noted. (PASS)

- E. Detached element, fragments or other debris from the test article, or vehicular damage should not block the driver's vision or otherwise cause the driver to lose control of the vehicle.*

Results: The fractured pieces of the Option B temporary work zone sign support did not block the driver's view and would not cause the driver to lose control of the 1100C vehicle. (PASS)

F. *The vehicle should remain upright during and after collision. The maximum roll and pitch angles are not to exceed 75 degrees.*

Results: The 1100C vehicle remained upright during and after the collision event. (PASS)

H. *Occupant impact velocities should satisfy the following:*

Longitudinal and Lateral Occupant Impact Velocity

<u><i>Preferred</i></u>	<u><i>Maximum</i></u>
<i>10 ft/s</i>	<i>16.4 ft/s</i>

Results: Assessment of occupant risk factors is not required for test articles having a total weight of 220 lb or less. (NA)

I. *Occupant ridedown accelerations should satisfy the following:*

Longitudinal and Lateral Occupant Ridedown Accelerations

<u><i>Preferred</i></u>	<u><i>Maximum</i></u>
<i>15 G</i>	<i>20.49 G</i>

Results: Assessment of occupant risk factors is not required for test articles having a total weight of 220 lb or less. (NA)

6.4.8.3 Vehicle Trajectory

N. *Vehicle trajectory behind the test article is acceptable.*

Results: The 1100C vehicle came to rest 438 ft behind the Option B temporary work zone sign support. (PASS)

6.4.9 Conclusions

Figure 6.19 provides a summary of the results of the test. The slip connection of Option B temporary work zone sign support performed as designed and permitted the top of the system to release from the lower section. There was no secondary contact between the sign panel and the roof of the vehicle.

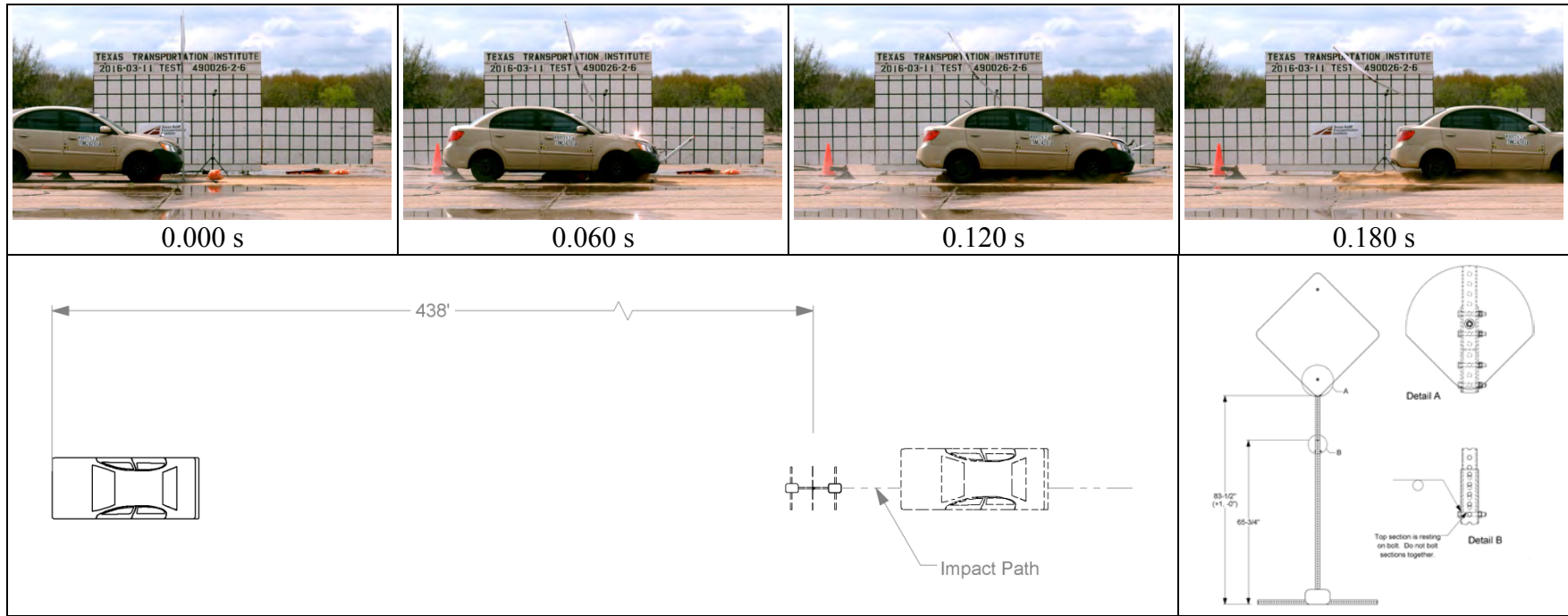

General Information

Test Agency Texas A&M Transportation Institute (TTI)
 Test Standard Test No. MASH Test 3-71
 TTI Test No. 490026-2-6
 Test Date 2016-03-11

Test Article

Type Temporary Work Zone Sign Support
 Name Option B Temporary Work Zone Sign Support
 Installation Height 83½ inches to bottom; 132¾ to top
 Material or Key Elements Upper & middle sections joined with two opposing fuse plates; smaller 1½ inch middle section had telescopic slip joint inside 1 ¾ inch lower section of vertical support

Soil Type and Condition Placed on dry concrete surface

Test Vehicle

Type/Designation1100C
 Make and Model.....2011 Kia Rio
 Curb2479 lb
 Test Inertial2443 lb
 Dummy.....165 lb
 Gross Static.....2608 lb

Impact Conditions

Speed.....61.7 mi/h
 Angle.....0 degrees
 Location/Orientation10 inches right of centerline 311 kip-ft

Kinetic Energy59.7 mi/h

Exit Conditions NA

Speed.....Assessment of occupant
 Angle.....risk factors not required

Occupant Risk Valuesfor test articles of 58 lb

Test Article Debris Scatter

Longitudinal 185 ft downstream
 Lateral.....12 ft right of center

Post-Impact Trajectory

Stopping Distance438 ft downstream
 Centerline

Vehicle Stability

Maximum Yaw AngleVehicle
 Maximum Pitch Angle remained
 Maximum Roll Angle upright
 Vehicle SnaggingNo
 Vehicle PocketingNo

Vehicle Damage

VDS12FR1
 CDC.....12FREN1
 Max. Exterior Deformation.....None
 OCDI.....RF000000
 Max. Occupant Compartment DeformationNone

Figure 6.19. Summary of Results for MASH Test 3-71 at 0 Degrees on the Option B Temporary Work Zone Sign Support.

6.5 MASH TEST 3-72 AT 0 DEGREES (CRASH TEST NO. 490026-2-8)

6.5.1 Test Designation and Actual Impact Conditions

MASH Test 3-72 involves a 2270P vehicle weighing 5000 lb \pm 110 lb impacting the Option B temporary work zone sign support at an impact speed of 62.2 mi/h \pm 2.5 mi/h and CIA \pm 1.5 degrees. The CIA for MASH Test 3-72 on the temporary work zone sign support was 0 degrees. The 2010 Dodge Ram 1500 pickup truck used in the test weighed 5014 lb, and the actual impact speed and angle were 62.1 mi/h and 0 degrees, respectively. The actual impact point was 10 inches left of vehicle's centerline. The target KE was \geq 594 kip-ft, and the actual KE at impact was 646 kip-ft. Figure 6.20 shows the installation before the test.

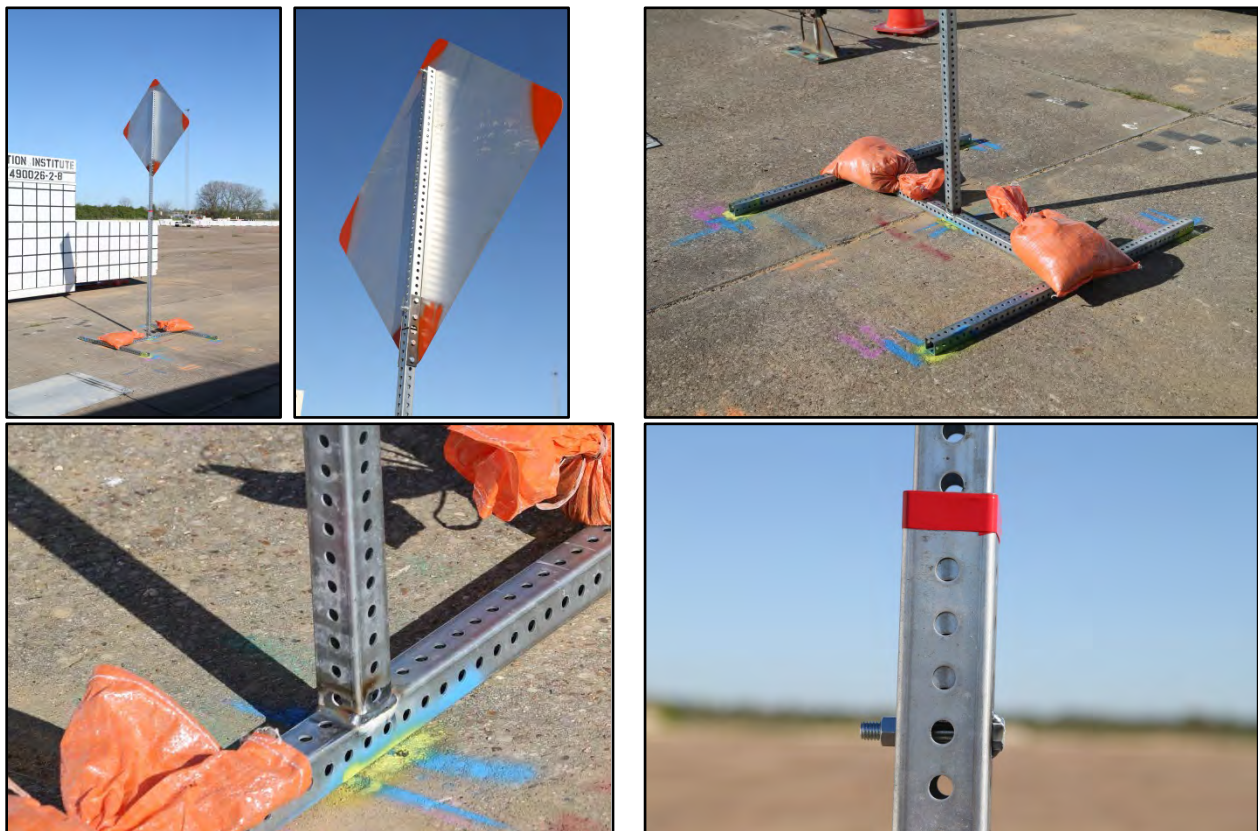

Figure 6.20. Option A Temporary Work Zone Sign Support Used for Test No. 490026-2-8.

6.5.2 Weather Conditions

The test was performed on the morning of March 14, 2016. Weather conditions at the time of testing were as follows: wind speed: 3 mi/h; wind direction: 192 degrees with respect to the vehicle (vehicle was traveling in a northerly direction); temperature: 70°F; relative humidity: 63 percent.

6.5.3 Test Vehicle

The 2010 Dodge Ram 1500 pickup, shown in Figure 6.21, was used for the crash test. The vehicle's test inertia weight was 5014 lb, and its gross static weight was 5014 lb. The height to the lower edge of the vehicle bumper was 12.5 inches, and the height to the upper edge of the vehicle bumper was 27.5 inches. The height to the vehicle's center of gravity was 28.4 inches. Tables E.1 and E.2 in Appendix E1 give additional dimensions and information on the vehicle. The vehicle was directed into the installation using a cable reverse tow and guidance system, and was released to be freewheeling and unrestrained just prior to impact.



Figure 6.21. Test Vehicle before Test No. 490026-2-8.

6.5.4 Test Description

The 2010 Dodge Ram 1500 pickup, traveling at an impact speed of 62.1 mi/h, contacted the Option B temporary work zone sign support 10 inches to the left of centerline of the vehicle at an impact angle of 0 degrees. At 0.004 s after impact, the support contacted the upper grill, and at 0.005 s, the base of the support began to lift off and slide along the surface of the concrete pavement. The upper section of the support began to slide out of the lower section at 0.007 s, and the upper section lost contact with the lower section of the support at 0.018 s. At 0.020 s, the lower section of the vertical support began to rupture at bumper height, and at 0.058 s, the vehicle lost contact with the lower section of the support. The lower section of the support contacted the concrete pavement at 0.075 s. At loss of contact with the support, the vehicle was traveling at a speed of 61.1 mi/h. Brakes on the vehicle were applied after loss of contact with the sign panel, and the vehicle came to rest 409 ft downstream of impact and 21 ft to the left of centerline of the impact path. Figure E.1 in Appendix E2 presents sequential photographs during the test.

6.5.5 Damage to Test Installation

Figure 6.22 shows the damage to the Option B temporary work zone sign support. The sign panel and the attached middle and upper sections of the vertical support came to rest 10 ft downstream of impact and 3 ft to the right of centerline of the impact path. The lower section of the vertical support fractured into two pieces 24 inches above ground level. The upper fractured piece came to rest 125 ft downstream and 15 ft to the left of centerline of the vehicle path. The

remaining lower portion and H-base of the temporary work zone sign support came to rest 83 ft downstream of impact. The H-shaped base came to rest 8 ft downstream of impact.



Figure 6.22. Option A Temporary Work Zone Sign Support after Test No. 490026-2-8.

6.5.6 Vehicle Damage

Figure 6.23 shows the damage sustained by the vehicle. The bumper and hood were damaged. Maximum exterior crush to the vehicle was 4.0 inches in the front plane at the left quarter point at bumper height. Figure 6.24 shows the interior of the vehicle. No occupant compartment deformation or intrusion was noted. Tables E.3 and E.4 in Appendix E1 provide exterior crush and occupant compartment measurements.

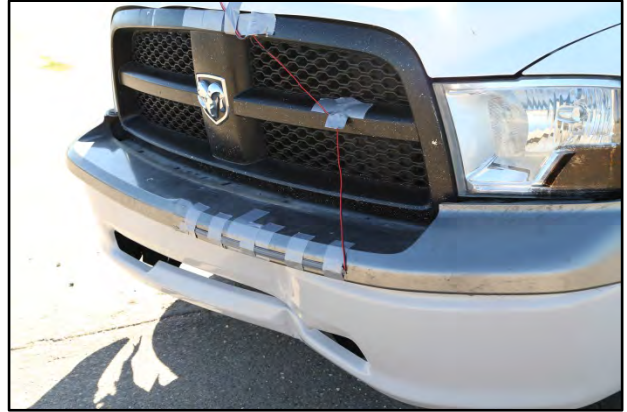

Figure 6.23. Test Vehicle after Test No. 490026-2-8.



Figure 6.24. Interior of Test Vehicle after Test No. 490026-2-8.

6.5.7 Occupant Risk Factors

No accelerometer or other types of instrumentation were installed in the vehicle. *MASH* states that Test 3-72 “can be conducted without the instrumentation necessary for determining occupant risk whenever the test article has a total weight of 220 lb or less. In this case, vehicle intrusion, windshield damage, and vehicle stability are the primary performance evaluation factors.” The weight of the temporary work zone sign support system was 62 lb.

6.5.8 Assessment of Test Results

An assessment of the test based on the applicable *MASH* safety evaluation criteria for *MASH* test 3-72 is provided below.

6.5.8.1 Structural Adequacy

- B. The test article should readily activate in a predictable manner by breaking away, fracturing, or yielding.*

Results: The Option B temporary work zone sign support readily activated by yielding to the 2270P vehicle, releasing at the slip joint, and fracturing. (PASS)

6.5.8.2 Occupant Risk

D. *Detached elements, fragments, or other debris from the test article should not penetrate or show potential for penetrating the occupant compartment, or present an undue hazard to other traffic, pedestrians, or personnel in a work zone.*

Deformation of, or intrusions into, the occupant compartment should not exceed limits set forth in Section 5.3 and Appendix E of MASH (roof ≤ 4.0 inches; windshield = ≤ 3.0 inches; side windows = no shattering by test article structural member; wheel/foot well/toe pan ≤ 9.0 inches; forward of A-pillar ≤ 12.0 inches; front side door area above seat ≤ 9.0 inches; front side door below seat ≤ 12.0 inches; floor pan/transmission tunnel area ≤ 12.0 inches).

Results: The Option B temporary work zone sign support released and fractured but did not penetrate or show signs for potential penetration of the vehicle. (PASS)

No occupant compartment penetration, deformation, or intrusion was noted. (PASS)

E. *Detached element, fragments or other debris from the test article, or vehicular damage should not block the driver's vision or otherwise cause the driver to lose control of the vehicle.*

Results: The released and fractured pieces of the Option B temporary work zone sign support did not block the driver's view and would not cause the driver to lose control of the 2270P vehicle. (PASS)

F. *The vehicle should remain upright during and after collision. The maximum roll and pitch angles are not to exceed 75 degrees.*

Results: The 2270P vehicle remained upright during and after the collision event. (PASS)

H. *Occupant impact velocities should satisfy the following:*

<u>Longitudinal and Lateral Occupant Impact Velocity</u>	
<u>Preferred</u>	<u>Maximum</u>
10 ft/s	16.4 ft/s

Results: Assessment of occupant risk factors is not required for test articles having a total weight of 220 lb or less. (NA)

- I. *Occupant ridedown accelerations should satisfy the following:*
Longitudinal and Lateral Occupant Ridedown Accelerations

<u>Preferred</u>	<u>Maximum</u>
15 G	20.49 G

Results: Assessment of occupant risk factors is not required for test articles having a total weight of 220 lb or less. (NA)

6.5.8.3 Vehicle Trajectory

- N. *Vehicle trajectory behind the test article is acceptable.*

Results: The 2270P vehicle came to rest 409 ft behind the installation.
(PASS)

6.5.9 Conclusions

Figure 6.25 provides a summary of the results of the test. The slip connection of Option B temporary work zone sign supports performed as designed and the top of the system released from the lower section. The lower section of the vertical support fractured but did not penetrate or show potential for penetrating the vehicle. No occupant compartment deformation or intrusion was noted. The fractured pieces of the Option B temporary work zone sign support did not block the driver's view and would not cause the driver to lose control of the 2270P vehicle. The 2270P vehicle remained upright during and after the collision event. The 2270P vehicle came to rest 409 ft behind the installation.

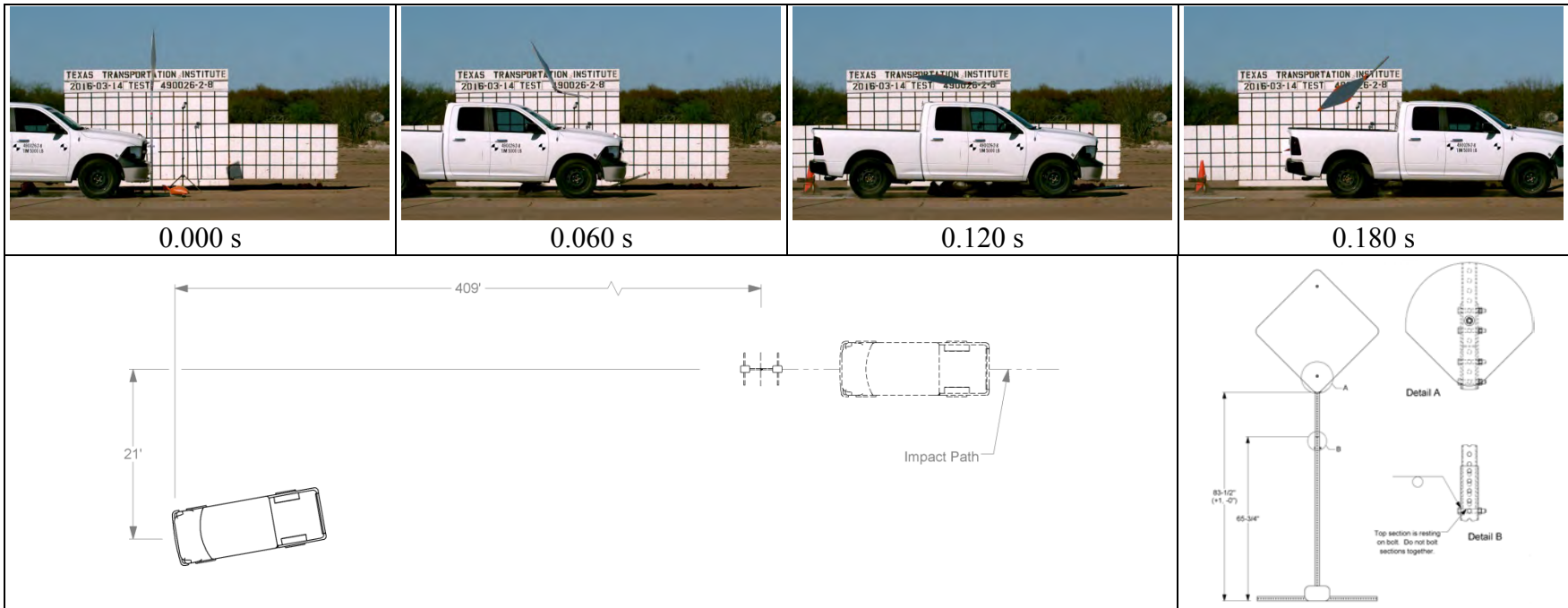

General Information

Test Agency..... Texas A&M Transportation Institute (TTI)
 Test Standard Test No. MASH Test 3-72
 TTI Test No. 490026-2-8
 Test Date..... 2016-03-14

Test Article

Type Temporary Work Zone Sign Support
 Name..... Option B Temporary Work Zone Sign Support
 Installation Height 83½ inches to bottom; 132½ to top
 Material or Key Elements Upper & middle sections joined with two opposing fuse plates; smaller 1½ inch middle section had telescopic slip joint inside 1 ¾ inch lower section of vertical support ,

Soil Type and Condition Placed on dry concrete surface

Test Vehicle

Type/Designation2270P
 Make and Model.....2010 Dodge Ram 1500
 Curb4898 lb
 Test Inertial5014 lb
 Dummy.....No dummy
 Gross Static.....5014 lb

Impact Conditions

Speed.....62.1 mi/h
 Angle.....0 degrees
 Location/Orientation 10 inches left of centerline

Kinetic Energy

..... 646 kip-ft

Exit Conditions

Speed.....61.1 mi/h
 Angle.....NA

Occupant Risk ValuesAssessment of occupant risk factors not required for test articles of 58 lb

Test Article Debris Scatter

Longitudinal 125 downstream
 Lateral 15 ft left of center
 3 ft right of center

Post-Impact Trajectory

Stopping Distance..... 409 ft downstream
 21 ft left of center

Vehicle Stability

Maximum Yaw Angle Vehicle
 Maximum Pitch Angle remained
 Maximum Roll Angle..... upright
 Vehicle Snagging..... No
 Vehicle Pocketing No

Vehicle Damage

VDS..... 01FL1
 CDC 01FLEN1
 Max. Exterior Deformation 4.0 inches
 OCDI FR000000
 Max. Occupant Compartment Deformation..... None

Figure 6.25. Summary of Results for MASH Test 3-72 at 0 Degrees on the Option B Temporary Work Zone Sign Support.

Chapter 7. OPTION C TEMPORARY WORK ZONE SIGN SUPPORT

7.1 OPTION C DESIGN AND CONSTRUCTION

The Option C test installation consisted of a single aluminum sign mounted on a two-piece vertical supported fabricated from 1³/₄-inch and 1¹/₂-inch, 12-gauge (0.105 inch) nominal thickness perforated square steel tubing containing ⁷/₁₆-inch diameter holes on 1-inch spacing on all four sides. The sign panel measured 36 inches square and was fabricated from 0.100-inch thick aluminum. The sign was mounted in a diamond configuration with a tip-to-tip distance of 49¹/₈ inches as a result of each corner having a 2-inch radius. The vertical support and sign were mounted to an H-shaped base measuring 48 inches × 51¹/₂ inches comprised of three 48-inch long sections of 1³/₄-inch perforated square steel tubing. Junctions of the 3-piece base and lower section of the vertical support post were joined with fillet welds. The sign was attached to the upper section of the vertical support with two ³/₈-inch diameter × 2¹/₂-inch long SAE grade 5 hex bolts, nuts, and flat and lock washers. Two 40-lb sandbags were placed on top of the H-shaped base, one at the midpoint of each outrigger. The approximate total weight of each test assembly was 57 lb (16-lb sign panel, 17-lb sectional post, and 24-lb 3-piece base) exclusive of two 40-lb sandbags.

For Option C, the upper section of the vertical support was comprised of a 48-inch length of 1¹/₂-inch, 12-gauge (0.105-inch) nominal thickness perforated square steel tubing. This upper section was inserted approximately 4⁹/₃₂ inches into the lower section of 1³/₄-inch perforated square steel tubing to form a slip joint. The upper section rested on a ³/₈-inch diameter × 2¹/₄-inch long smooth pin located in the holes 4¹/₂ inches below the top end of the lower section. The pin was welded to one side of the lower section. The top of the lower section was 83³/₄ inches above grade. The bottom and top of the sign panel were 84¹/₂ inches and 133⁵/₈ inches above grade, respectively.

Figure 7.1 shows details of the Option C temporary work zone sign and post installation. Figure 7.2 provides photographs of the completed installation.

7.2 MASH TEST 3-72 AT 90 DEGREES (CRASH TEST NO. 490026-2-3)

7.2.1 Test Designation and Actual Impact Conditions

MASH Test 3-72 involves a 2270P vehicle weighing 5000 lb ±110 lb impacting the Option C temporary work zone sign support at an impact speed of 62.2 mi/h ±2.5 mi/h and CIA ±1.5 degrees. The CIA for *MASH* Test 3-72 on the temporary work zone sign support was 90 degrees. The 2010 Dodge Ram 1500 pickup truck used in the test weighed 5014 lb, and the actual impact speed and angle were 62.5 mi/h and 90 degrees, respectively. The actual impact point was the centerline of the front of the vehicle. The target KE was ≥594 kip-ft, and the actual KE at impact was 653 kip-ft. Figure 7.2 shows the installation before the test.

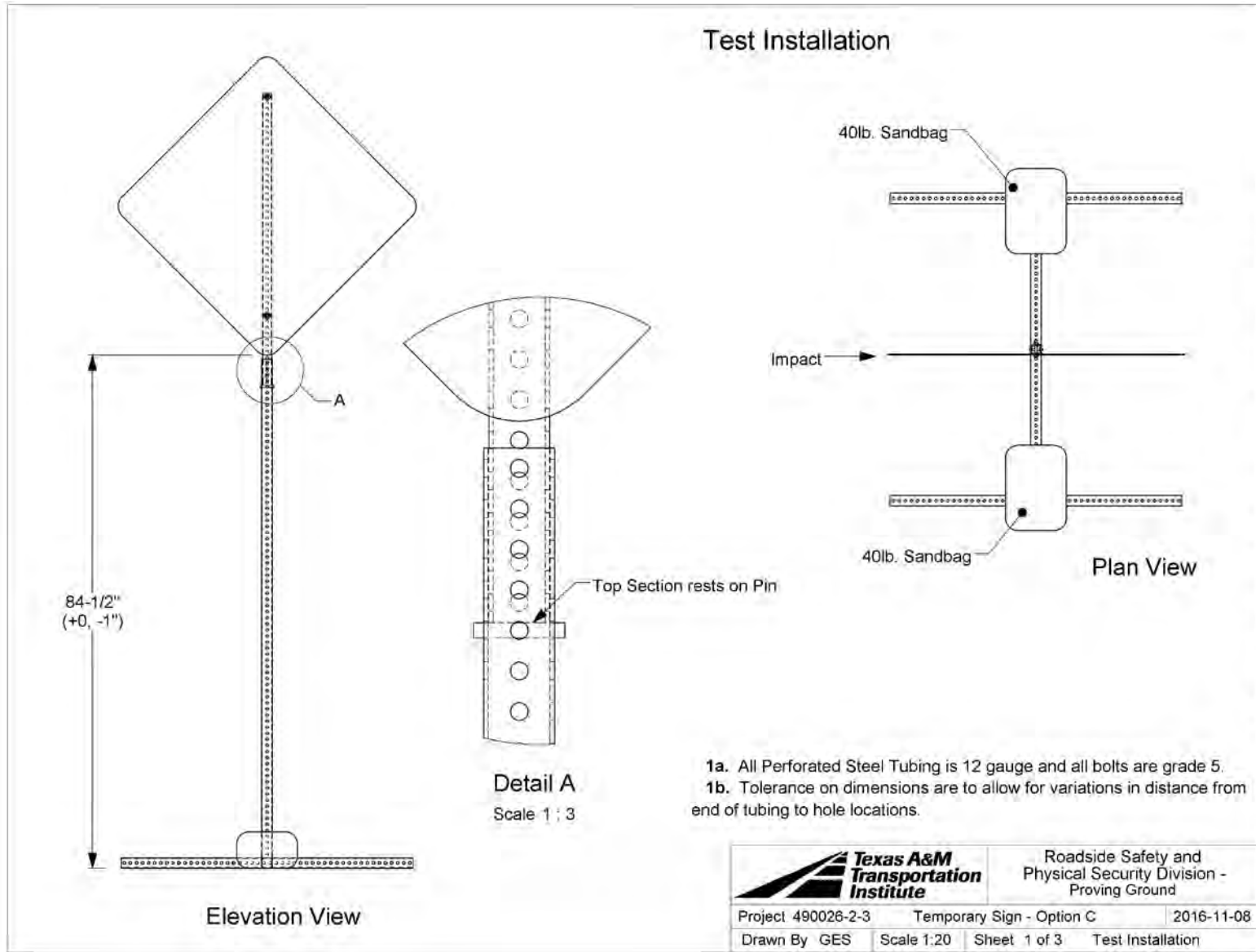

T:\11-ProjectFiles\490026-TxDOT\2 - Temporary Single Leg Sign Support - Chisara\2-3\Drafting\490026-2-3 Drawing

Figure 7.1. Details of the Option C Temporary Work Zone Sign Support.

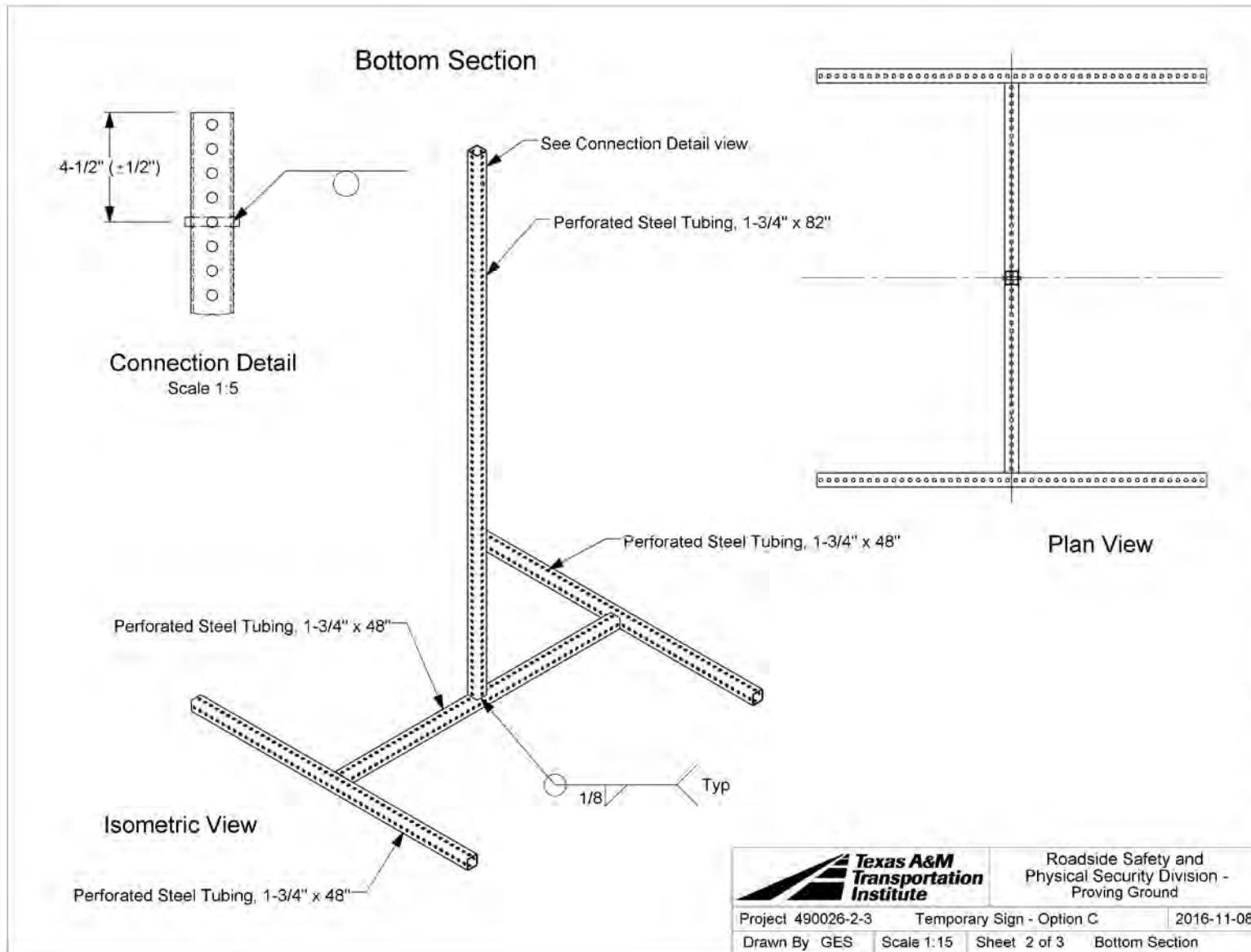

T:\11-ProjectFiles\490026-TxDOT\2 - Temporary Single Leg Sign Support - Chiara\2-3\Drafting\490026-2-3 Drawing

Figure 7.1. Details of the Option C Temporary Work Zone Sign Support (Continued).

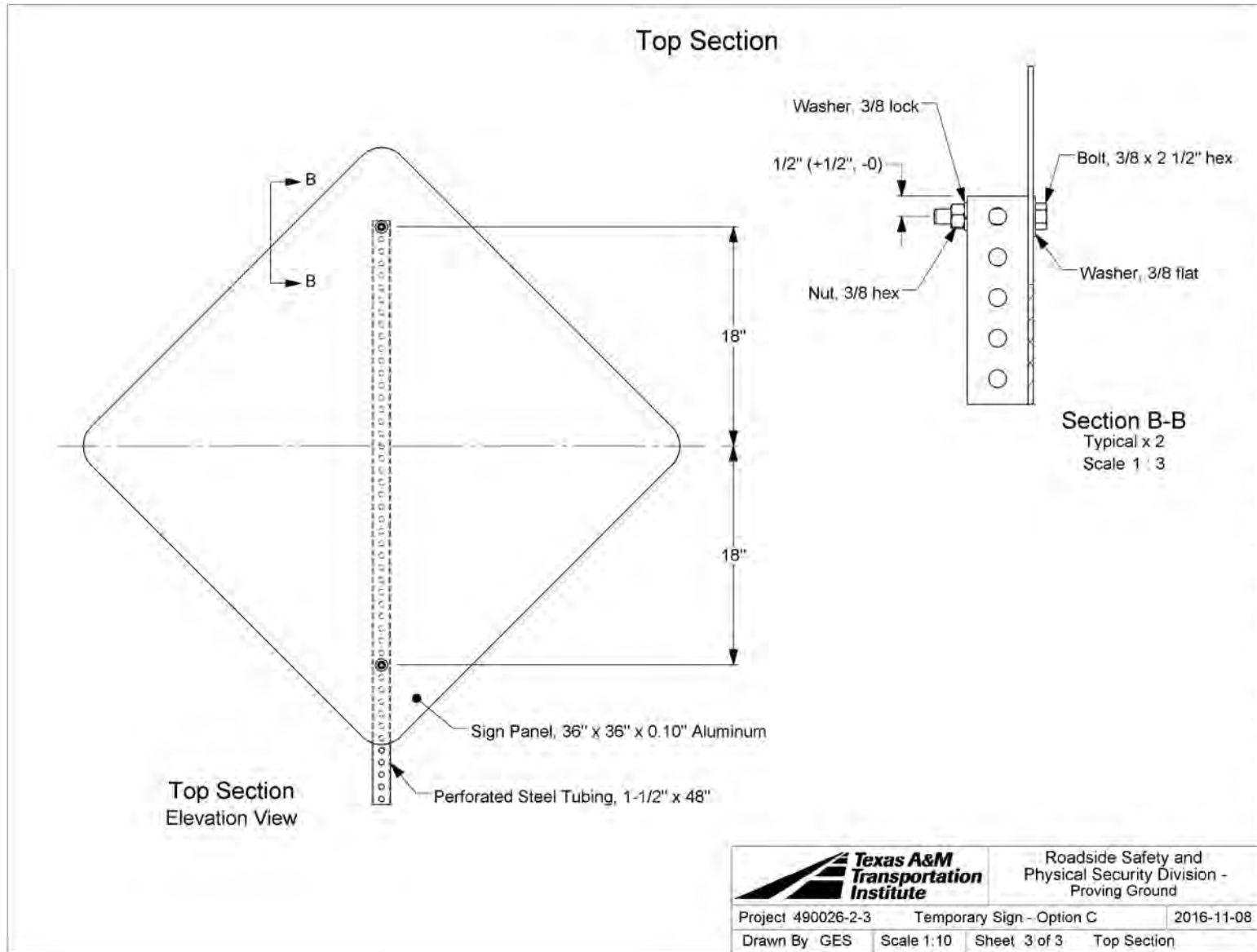

T:\1-ProjectFiles\490026-TxDOT\2 - Temporary Single Leg Sign Support - Chiarra\2-3\Drafting\490026-2-3-Drawing

Figure 7.1. Details of the Option C Temporary Work Zone Sign Support (Continued).

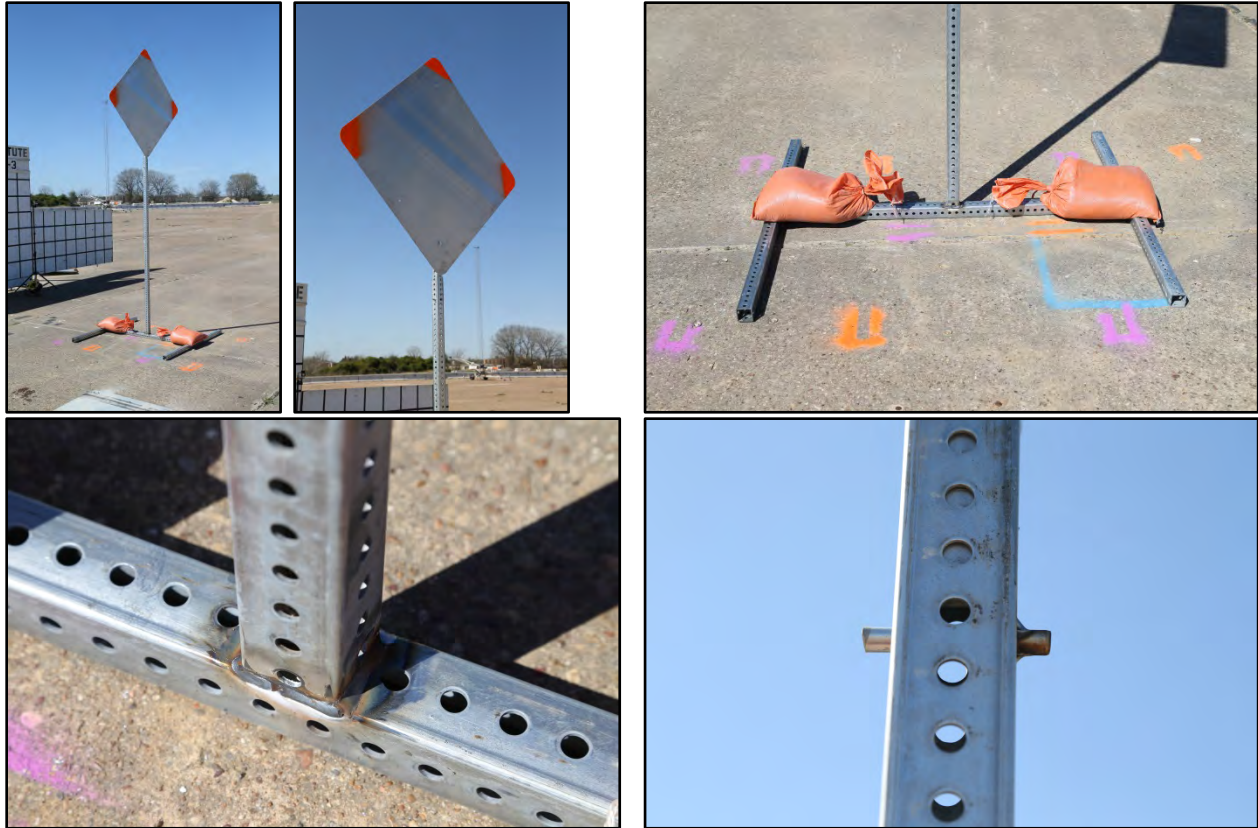

Figure 7.2. Option C Temporary Work Zone Sign Support Used for Test No. 490026-2-3.

7.2.2 Weather Conditions

The test was performed on the afternoon of March 3, 2016. Weather conditions at the time of testing were as follows: wind speed: 14 mi/h; wind direction: 350 degrees with respect to the vehicle (vehicle was traveling in a northerly direction); temperature: 81°F; relative humidity: 29 percent.

7.2.3 Test Vehicle

The 2010 Dodge Ram 1500 pickup, shown in Figure 7.3, was used for the crash test. The vehicle's test inertia weight was 5014 lb, and its gross static weight was 5014 lb. The height to the lower edge of the vehicle bumper was 12.5 inches, and the height to the upper edge of the vehicle bumper was 27.5 inches. The height to the vehicle's center of gravity was 28.4 inches. Tables F.1 and F.2 in Appendix F1 give additional dimensions and information on the vehicle. The vehicle was directed into the installation using the cable reverse tow and guidance system, and was released to be freewheeling and unrestrained just prior to impact.



Figure 7.3. Test Vehicle before Test No. 490026-2-3.

7.2.4 Test Description

The 2010 Dodge Ram 1500 pickup, traveling at an impact speed of 62.5 mi/h, contacted the Option C temporary work zone sign support with the centerline of the front bumper at an impact angle of 90 degrees. At 0.003 s, the support contacted the upper grill of the vehicle, and at 0.004 s, the base of the support began to lift off the concrete pavement. The upper section of the support began to pull out of the lower section at 0.008 s, the upper section of the support lost contact with the lower section at 0.032 s, and the sign panel was traveling above and parallel with the roof of the vehicle at 0.078 s. At 0.086 s, the sign panel contacted the roof 16.5 inches behind the windshield, and at 0.111 s, the sign panel lost contact with the roof. The vehicle was traveling at a speed of 60.8 mi/h at loss of contact. Brakes on the vehicle were applied after loss of contact with the sign panel, and the vehicle came to rest 347 ft downstream of impact. Figure F.1 in Appendix F2 presents sequential photographs during the test.

7.2.5 Damage to Test Installation

Figure 7.4 shows the damage to the Option C temporary work zone sign support. The sign panel and the attached upper section of the vertical support came to rest 35 ft downstream of impact and 3 ft to the right of centerline of the impact path. The remainder of the temporary work zone sign support became lodged under the 2270P vehicle and traveled along with the vehicle, which came to rest 347 ft downstream of impact and on the centerline of the impact path.



Figure 7.4. Option C Temporary Work Zone Sign Support after Test No. 490026-2-3.

7.2.6 Vehicle Damage

Figure 7.5 shows the damage sustained by the vehicle. The bumper, hood, and roof were scraped. Maximum exterior crush to the vehicle was 6 inches in the front plane at the centerline at bumper height. There was a 3-inch long dent on the outer surface of the front of the roof of the cab, but it did not extend into the passenger compartment. Figure 7.6 shows the interior of the vehicle. No occupant compartment deformation or intrusion was noted. Tables F.3 and F.4 in Appendix F1 provide exterior crush and occupant compartment measurements.

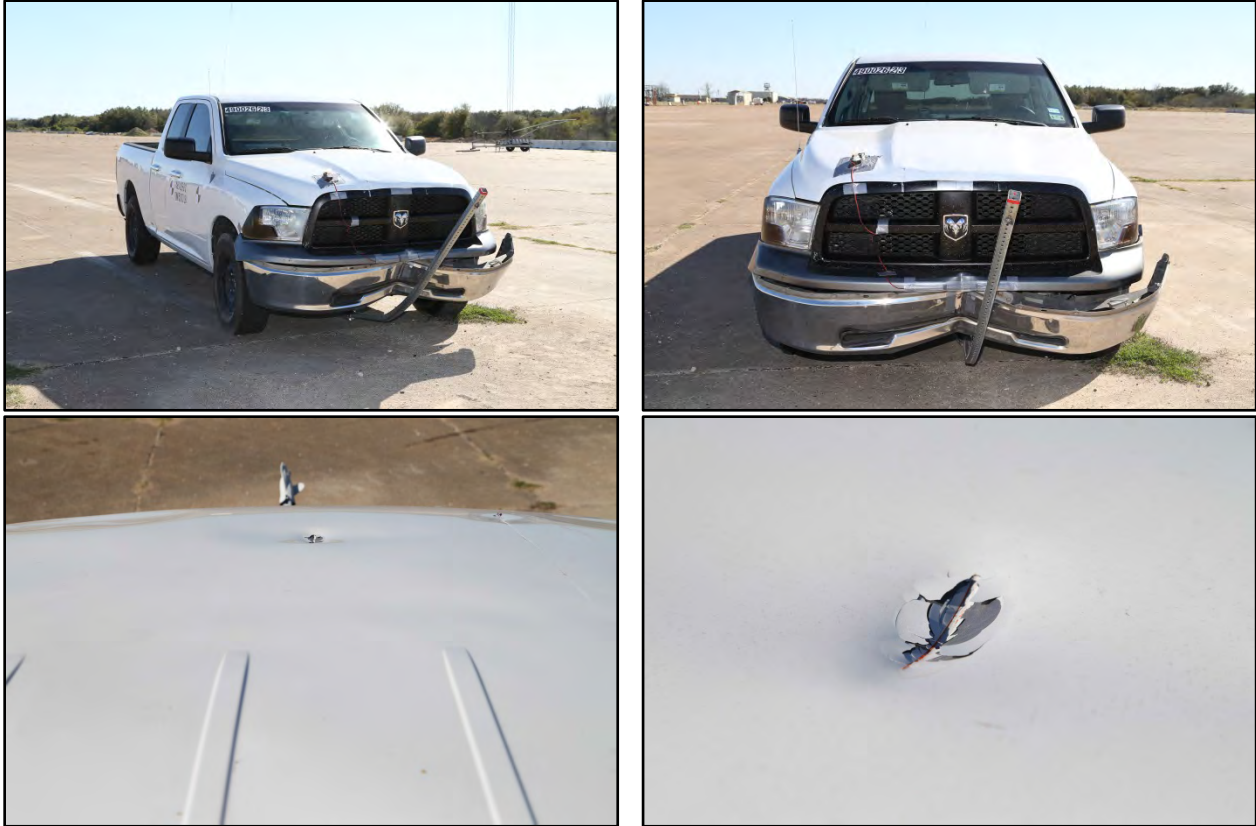

Figure 7.5. Test Vehicle after Test No. 490026-2-3.



Figure 7.6. Interior of Test Vehicle for Test No. 490026-2-3.

7.2.7 Occupant Risk Factors

No accelerometer or other types of instrumentation were installed in the vehicle. *MASH* states that Test 3-71 “can be conducted without the instrumentation necessary for determining occupant risk whenever the test article has a total weight of 220 lb or less. In this

case, vehicle intrusion, windshield damage, and vehicle stability are the primary performance evaluation factors.” The weight of the temporary work zone sign support system was 57 lb.

7.2.8 Assessment of Test Results

An assessment of the test based on the applicable *MASH* safety evaluation criteria for *MASH* test 3-72 is provided below.

7.2.8.1 Structural Adequacy

- B. The test article should readily activate in a predictable manner by breaking away, fracturing, or yielding.*

Results: The Option C temporary work zone sign support readily activated by yielding to the 2270P vehicle and releasing at the slip joint. (PASS)

7.2.8.2 Occupant Risk

- D. Detached elements, fragments, or other debris from the test article should not penetrate or show potential for penetrating the occupant compartment, or present an undue hazard to other traffic, pedestrians, or personnel in a work zone.*

Deformation of, or intrusions into, the occupant compartment should not exceed limits set forth in Section 5.3 and Appendix E of MASH (roof ≤ 4.0 inches; windshield = ≤ 3.0 inches; side windows = no shattering by test article structural member; wheel/foot well/toe pan ≤ 9.0 inches; forward of A-pillar ≤ 12.0 inches; front side door area above seat ≤ 9.0 inches; front side door below seat ≤ 12.0 inches; floor pan/transmission tunnel area ≤ 12.0 inches).

Results: The Option C temporary work zone sign support released at the slip joint into two pieces; however, there was no concern for penetration or intrusion into the vehicle. The lower portion of the sign support lodged under the truck and traveled with the vehicle. (PASS)

No occupant compartment deformation or intrusion was noted. (PASS)

- E. Detached element, fragments or other debris from the test article, or vehicular damage should not block the driver’s vision or otherwise cause the driver to lose control of the vehicle.*

Results: The fractured pieces of the Option C temporary work zone sign support did not block the driver’s view and would not cause the driver to lose control of the 2270P vehicle. (PASS)

- F. The vehicle should remain upright during and after collision. The maximum roll and pitch angles are not to exceed 75 degrees.*

Results: The 2270P vehicle remained upright during and after the collision event. (PASS)

H. *Occupant impact velocities should satisfy the following:*

Longitudinal and Lateral Occupant Impact Velocity

<u><i>Preferred</i></u>	<u><i>Maximum</i></u>
<i>10 ft/s</i>	<i>16.4 ft/s</i>

Results: Assessment of occupant risk factors is not required for test articles having a total weight of 220 lb or less. (NA)

I. *Occupant ridedown accelerations should satisfy the following:*

Longitudinal and Lateral Occupant Ridedown Accelerations

<u><i>Preferred</i></u>	<u><i>Maximum</i></u>
<i>15 G</i>	<i>20.49 G</i>

Results: Assessment of occupant risk factors is not required for test articles having a total weight of 220 lb or less. (NA)

7.2.8.3 Vehicle Trajectory

N. *Vehicle trajectory behind the test article is acceptable.*

Results: The 2270P vehicle came to rest 347 ft behind the original position of the Option C temporary work zone sign support. (PASS)

7.2.9 Conclusions

Figure 7.7 provides a summary of the results of the test. The slip connection for Option C temporary work zone sign support performed as designed and the top of the system released from the lower section. The sign panel contacted the roof; however, it did not cause any tears or penetration. The resulting roof deformation was within *MASH* criteria.

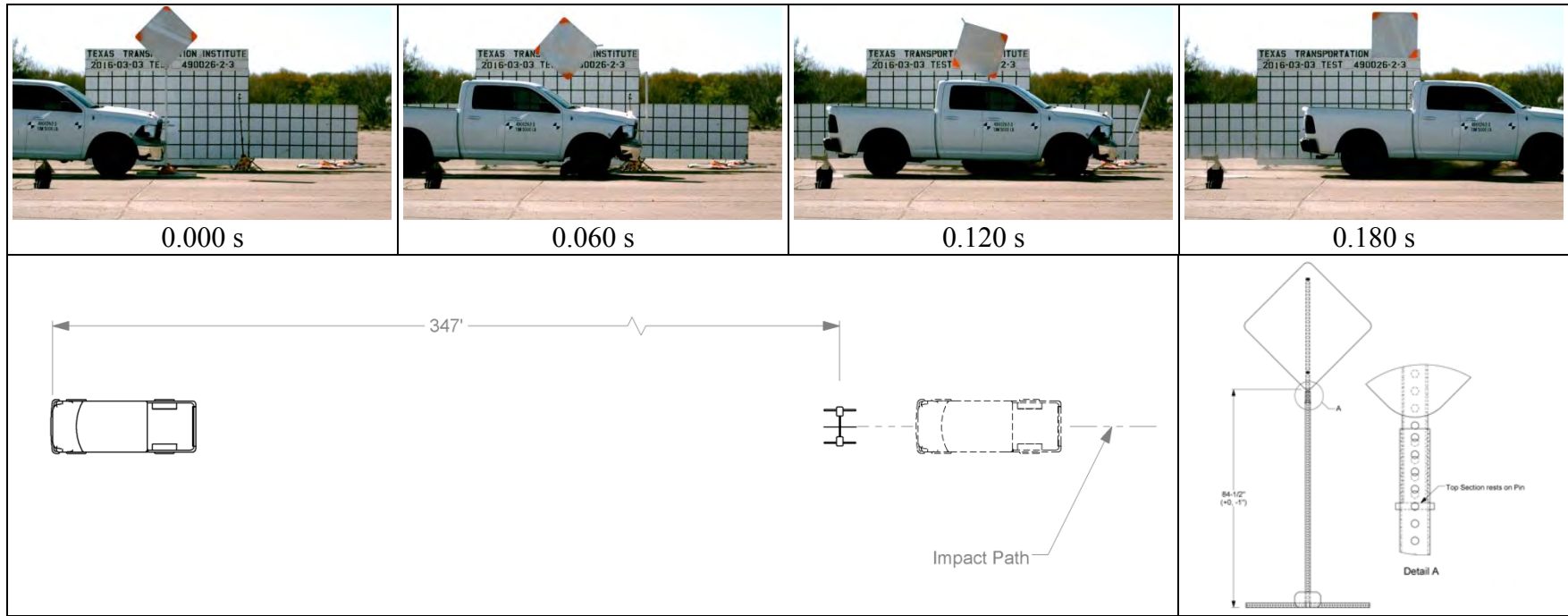

General Information

Test Agency Texas A&M Transportation Institute (TTI)
 Test Standard Test No. MASH Test 3-72
 TTI Test No. 490026-2-3
 Test Date 2016-03-03

Test Article

Type Temporary Work Zone Sign Support
 Name Option C Temporary Work Zone Sign Support
 Installation Height 84½ inches to bottom; 133¾ to top
 Material or Key Elements Upper section inserted 4⁹/₃₂ inches into the lower 1¾-inch square tubing post and rested on a ¾-inch diameter × 2¼-inch long smooth pin located in holes 4½ inches below the top of post

Soil Type and Condition Placed on dry concrete surface

Test Vehicle

Type/Designation 2270P
 Make and Model 2010 Dodge Ram 1500
 Curb 4898 lb
 Test Inertial 5014 lb
 Dummy No dummy
 Gross Static 5014 lb

Impact Conditions

Speed 62.5 mi/h
 Angle 90 degrees
 Location/Orientation Centerline

Kinetic Energy 653 kip-ft

Exit Conditions

Speed 60.8 mi/h
 Angle NA

Occupant Risk Values Assessment of occupant risk factors not required for test articles of 57 lb

Test Article Debris Scatter

Longitudinal 347 downstream
 Lateral Centerline

Post-Impact Trajectory

Stopping Distance 347 ft downstream on center

Vehicle Stability

Maximum Yaw Angle Vehicle
 Maximum Pitch Angle remained
 Maximum Roll Angle upright
 Vehicle Snagging No
 Vehicle Pocketing No

Vehicle Damage

VDS 12FC1
 CDC 12FCEN1
 Max. Exterior Deformation 6.0 inches
 OCDI RR0000000
 Max. Occupant Compartment Deformation None

Figure 7.7. Summary of Results for MASH Test 3-72 at 90 Degrees on the Option C Temporary Work Zone Sign Support.

7.3 MASH TEST 3-71 AT 90 DEGREES (CRASH TEST NO. 490026-2-5)

7.3.1 Test Designation and Actual Impact Conditions

MASH Test 3-71 involves an 1100C vehicle weighing 2425 lb \pm 55 lb impacting the Option C temporary work zone sign support at an impact speed of 62.2 mi/h \pm 2.5 mi/h and CIA \pm 1.5 degrees. The CIA for MASH Test 3-71 on the temporary work zone sign support was 90 degrees. The 2011 Kia Rio used in the test weighed 2443 lb, and the actual impact speed and angle were 61.5 mi/h and 90 degrees, respectively. The actual impact point was 10 inches to the left of centerline of the vehicle. The target KE was \geq 288 kip-ft, and the actual KE at impact was 309 kip-ft. Figure 7.8 shows the installation before the test.

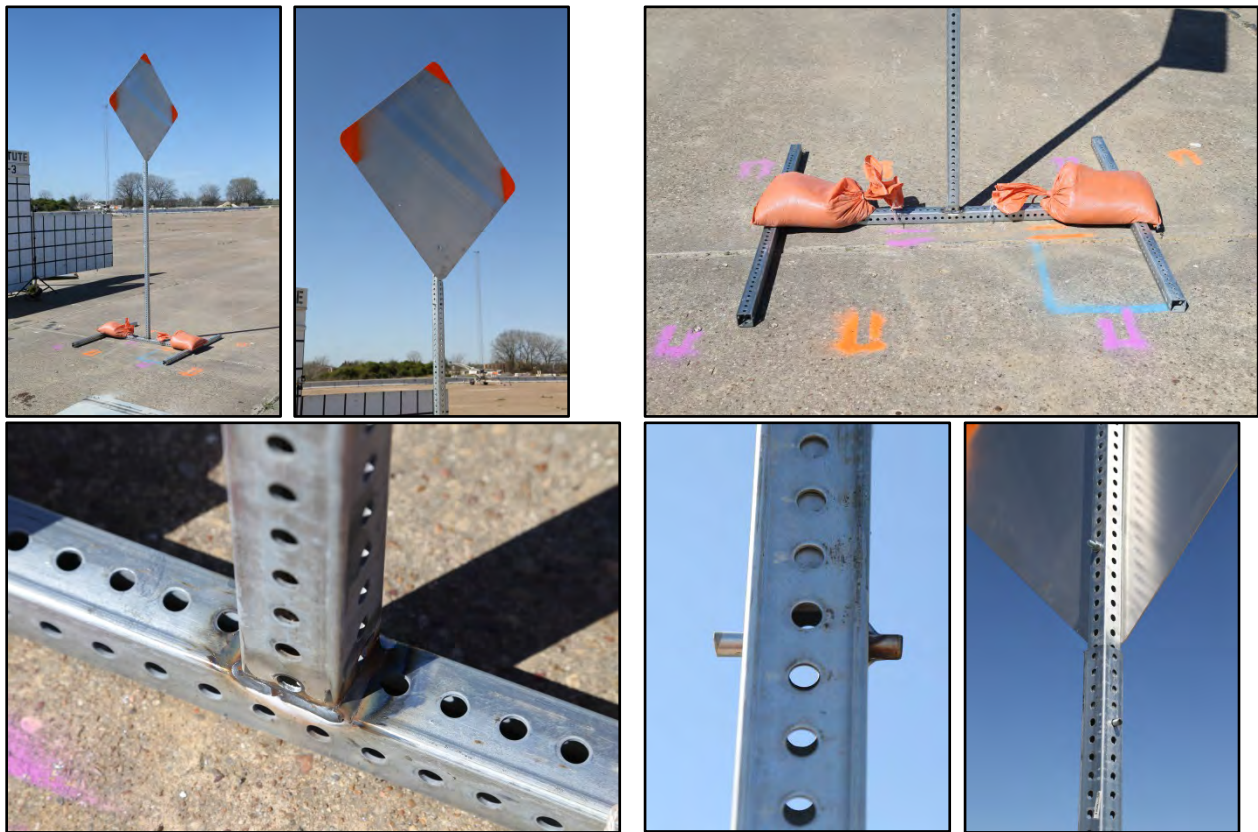

Figure 7.8. Option C Temporary Work Zone Sign Support Used for Test No. 490026-2-5.

7.3.2 Weather Conditions

The test was performed afternoon on March 11, 2016. Weather conditions at the time of testing were as follows: wind speed: 2 mi/h; wind direction: 205 degrees with respect to the vehicle (vehicle was traveling in a northerly direction); temperature: 67°F; relative humidity: 86 percent.

7.3.3 Test Vehicle

The 2011 Kia Rio for the previous test (test 490026-2-4), shown in Figure 7.9, was used for the crash test. The vehicle's test inertia weight was 2443 lb, and its gross static weight was 2608 lb. The height to the lower edge of the vehicle bumper was 8.0 inches, and the height to the upper edge of the vehicle bumper was 21.5 inches. Table G.1 in Appendix G1 gives additional dimensions and information on the vehicle. The vehicle was directed into the installation using the cable reverse tow and guidance system, and was released to be freewheeling and unrestrained just prior to impact.



Figure 7.9. Test Vehicle before Test No. 490026-2-5.

7.3.4 Test Description

The 2011 Kia Rio, traveling at an impact speed of 61.5 mi/h, contacted the Option C temporary work zone sign support 10 inches to the left of centerline of the vehicle at an impact angle of 90 degrees. At 0.004 s after impact, the upstream end of the base of the support began to lift off the concrete pavement, and at 0.007 s, the upper section of the support began to release from the lower section. The upper section of the support separated from the lower section at 0.024 s. At 0.140 s, the vehicle was traveling at a speed of 59.5 mi/h. Brakes on the vehicle were applied after loss of contact with the support, and the vehicle came to rest 500 ft downstream of impact. Figure G.1 in Appendix G2 presents sequential photographs during the test.

7.3.5 Damage to Test Installation

Figure 7.10 shows the damage to the Option C temporary work zone sign support. The sign panel and attached upper section of the vertical support came to rest at the point of impact. The remainder of the temporary work zone sign support rode along with the 1100C vehicle for a distance and then came to rest 230 ft downstream of impact and 25 ft to the left of centerline of the impact path.

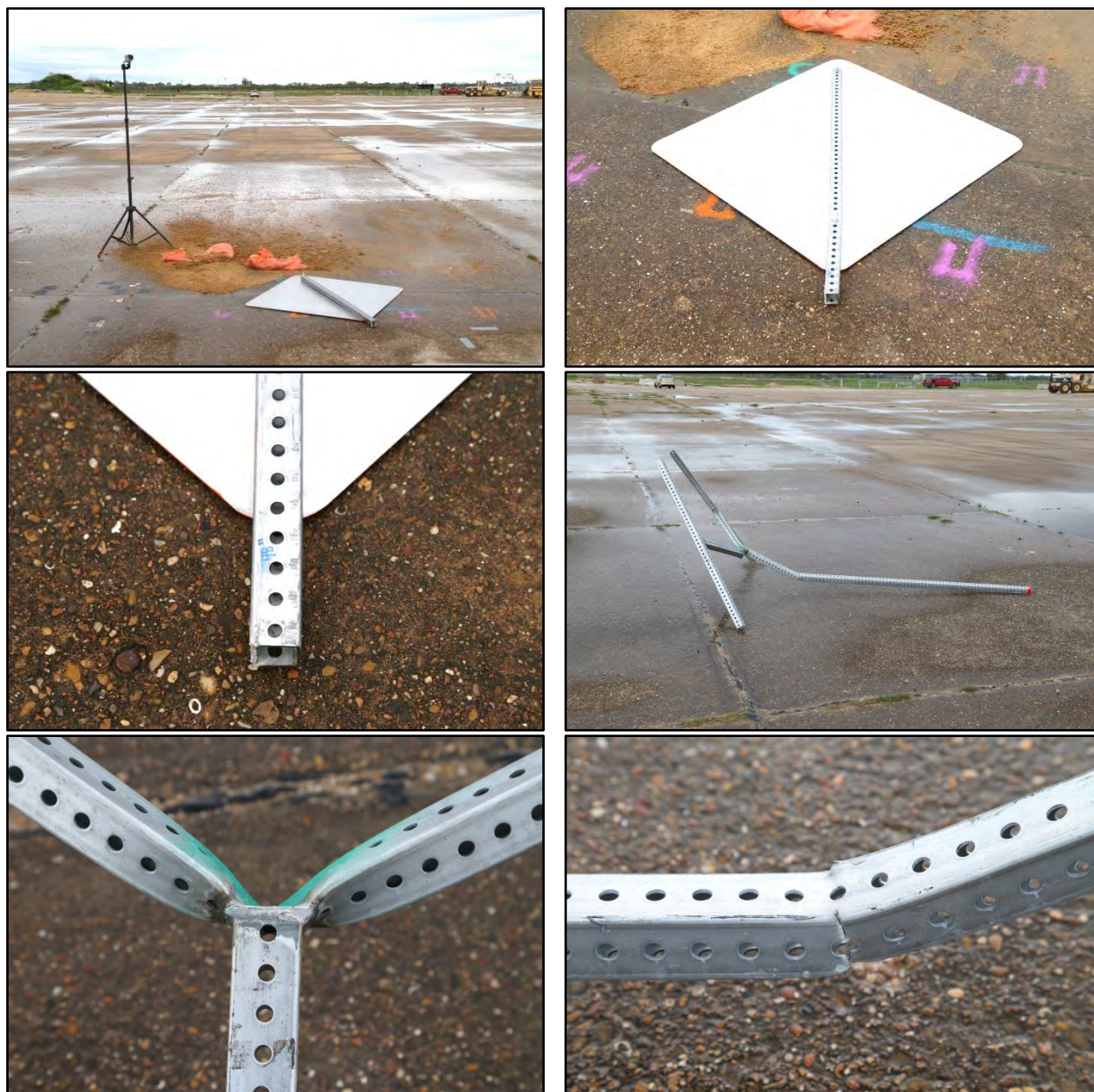

Figure 7.10. Option C Temporary Work Zone Sign Support after Test No. 490026-2-5.

7.3.6 Vehicle Damage

Figure 7.11 shows the damage sustained by the vehicle. The 1100C vehicle sustained only scrapes to the bumper and hood with no measureable exterior vehicle deformation. Figure 7.12 shows the interior of the vehicle. No occupant compartment deformation or intrusion was noted. Tables G.2 and G.3 in Appendix G1 provides exterior crush and occupant compartment measurements.



Figure 7.11. Test Vehicle after Test No. 490026-2-5.

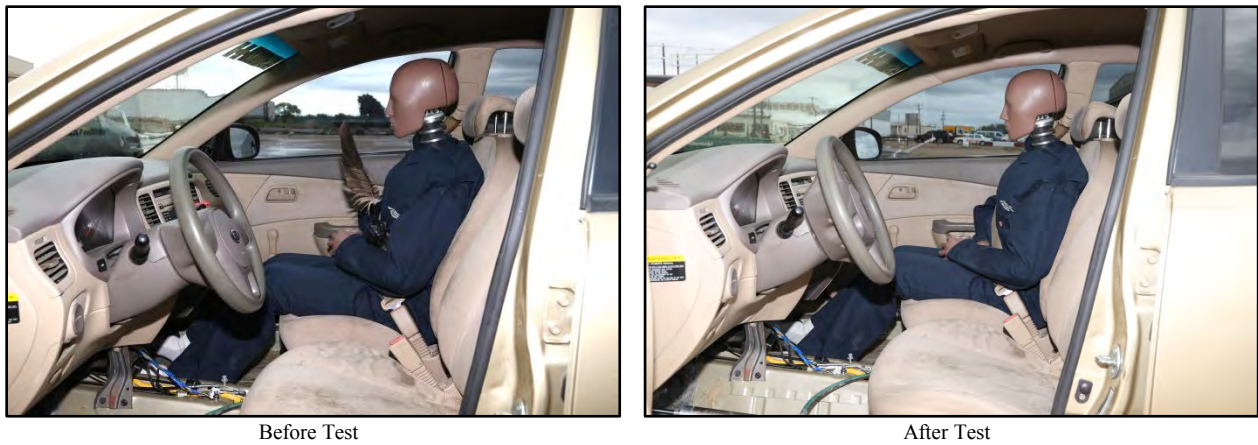

Figure 7.12. Interior of Test Vehicle for Test No. 490026-2-5.

7.3.7 Occupant Risk Factors

No accelerometer or other types of instrumentation were installed in the vehicle. *MASH* states that Test 3-71 “can be conducted without the instrumentation necessary for determining occupant risk whenever the test article has a total weight of 220 lb or less. In this

case, vehicle intrusion, windshield damage, and vehicle stability are the primary performance evaluation factors.” The weight of the temporary work zone sign support system was 57 lb.

7.3.8 Assessment of Test Results

An assessment of the test based on the applicable *MASH* safety evaluation criteria for *MASH* test 3-71 is provided below.

7.3.8.1 Structural Adequacy

- B. *The test article should readily activate in a predictable manner by breaking away, fracturing, or yielding.*

Results: The Option C temporary work zone sign support readily activated by yielding to the 1100C vehicle and releasing at the slip joint. (PASS)

7.3.8.2 Occupant Risk

- D. *Detached elements, fragments, or other debris from the test article should not penetrate or show potential for penetrating the occupant compartment, or present an undue hazard to other traffic, pedestrians, or personnel in a work zone.*

Deformation of, or intrusions into, the occupant compartment should not exceed limits set forth in Section 5.3 and Appendix E of MASH (roof ≤ 4.0 inches; windshield = ≤ 3.0 inches; side windows = no shattering by test article structural member; wheel/foot well/toe pan ≤ 9.0 inches; forward of A-pillar ≤ 12.0 inches; front side door area above seat ≤ 9.0 inches; front side door below seat ≤ 12.0 inches; floor pan/transmission tunnel area ≤ 12.0 inches).

Results: The Option C temporary work zone sign support released into two pieces; however, there was no concern for penetration or intrusion into the vehicle. The sign panel and upper portion of the support remained at the impact site. The lower portion of the sign support rode along with the 1100C vehicle for a distance and came to rest 230 ft downstream of impact and 25 ft left of the centerline of the vehicle path. (PASS)

No occupant compartment deformation or intrusion was noted. (PASS)

- E. *Detached element, fragments or other debris from the test article, or vehicular damage should not block the driver’s vision or otherwise cause the driver to lose control of the vehicle.*

Results: The released upper section of the Option C temporary work zone sign support did not block the driver’s view or otherwise cause the driver to lose control of the 1100C vehicle. (PASS)

F. *The vehicle should remain upright during and after collision. The maximum roll and pitch angles are not to exceed 75 degrees.*

Results: The 1100C vehicle remained upright during and after the collision event. (PASS)

H. *Occupant impact velocities should satisfy the following:*

Longitudinal and Lateral Occupant Impact Velocity

Preferred

10 ft/s

Maximum

16.4 ft/s

Results: Assessment of occupant risk factors is not required for test articles having a total weight of 220 lb or less. (NA)

I. *Occupant ridedown accelerations should satisfy the following:*

Longitudinal and Lateral Occupant Ridedown Accelerations

Preferred

15 G

Maximum

20.49 G

Results: Assessment of occupant risk factors is not required for test articles having a total weight of 220 lb or less. (NA)

7.3.8.3 Vehicle Trajectory

N. *Vehicle trajectory behind the test article is acceptable.*

Results: The 1100C vehicle came to rest 500 ft behind the Option C temporary work zone sign support. (PASS)

7.3.9 Conclusions

Figure 7.13 provides a summary of the results of the test. The slip connection of Option C temporary work zone sign support performed as designed and the top of the system released from the lower section at vehicle impact. The support structure contacted the bumper and hood, but the sign panel did not contact the roof of the vehicle.

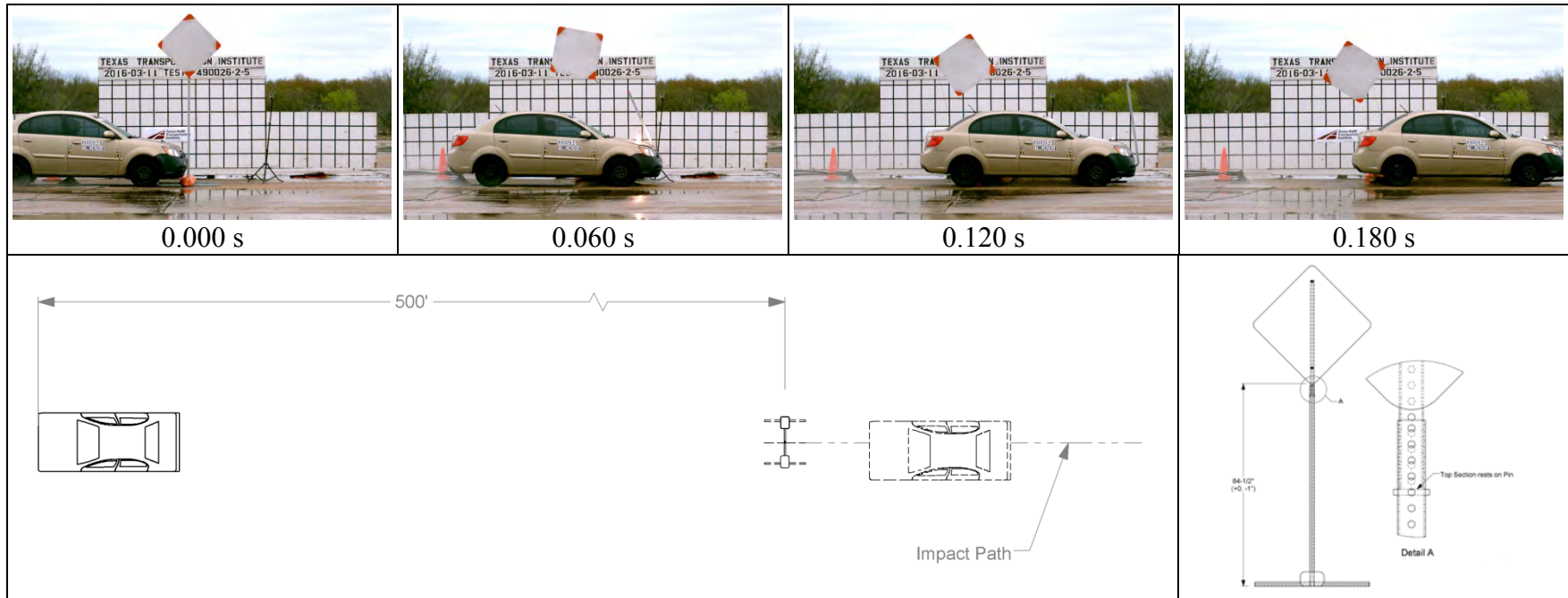

General Information

Test Agency..... Texas A&M Transportation Institute (TTI)
 Test Standard Test No..... MASH Test 3-71
 TTI Test No. 490026-2-5
 Test Date..... 2016-03-11

Test Article

Type Temporary Work Zone Sign Support
 Name..... Option C Temporary Work Zone Sign Support
 Installation Height 84½ inches to bottom; 133¾ to top
 Material or Key Elements Upper section inserted 4⁹/₃₂ inches into the lower 1¾-inch square tubing post and rested on a ¾-inch diameter × 2¼-inch long smooth pin located in holes 4½ inches below the top of post

Soil Type and Condition Placed on dry concrete surface

Test Vehicle

Type/Designation1100C
 Make and Model.....2011 Kia Rio
 Curb2479 lb
 Test Inertial2443 lb
 Dummy.....165 lb
 Gross Static.....2608 lb

Impact Conditions

Speed.....61.5 mi/h
 Angle.....90 degrees
 Location/Orientation10 inches left of centerline

Kinetic Energy309 kip-ft

Exit Conditions

Speed.....59.5 mi/h
 Angle.....NA

Occupant Risk Values Assessment of occupant risk factors not required for test articles of 57 lb

Test Article Debris Scatter

Longitudinal230 downstream
 Lateral.....25 ft left of center

Post-Impact Trajectory

Stopping Distance.....500 ft downstream Centerline

Vehicle Stability

Maximum Yaw Angle Vehicle
 Maximum Pitch Angle remained
 Maximum Roll Angle upright
 Vehicle Snagging No
 Vehicle Pocketing No

Vehicle Damage

VDS 12FL1
 CDC..... 12FLEN1
 Max. Exterior Deformation.....None
 OCDI.....LF0000000
 Max. Occupant Compartment DeformationNone

Figure 7.13. Summary of Results for MASH Test 3-71 at 90 Degrees on the Option C Temporary Work Zone Sign Support.

7.4 MASH TEST 3-71 AT 0 DEGREES (CRASH TEST NO. 490026-2-7)

7.4.1 Test Designation and Actual Impact Conditions

MASH Test 3-71 involves an I100C vehicle weighing 2425 lb \pm 55 lb and impacting the Option C temporary work zone sign support at an impact speed of 62.2 mi/h \pm 2.5 mi/h and CIA \pm 1.5 degrees. The CIA for MASH Test 3-71 on the temporary work zone sign support was 0 degrees. The 2011 Kia Rio used in the test weighed 2443 lb, and the actual impact speed and angle were 61.9 mi/h and 90 degrees, respectively. The actual impact point was 10 inches to the left of centerline of the vehicle. Target KE was \geq 288 kip-ft, and actual KE was 313 kip-ft. Figure 7.14 shows the installation before the test.

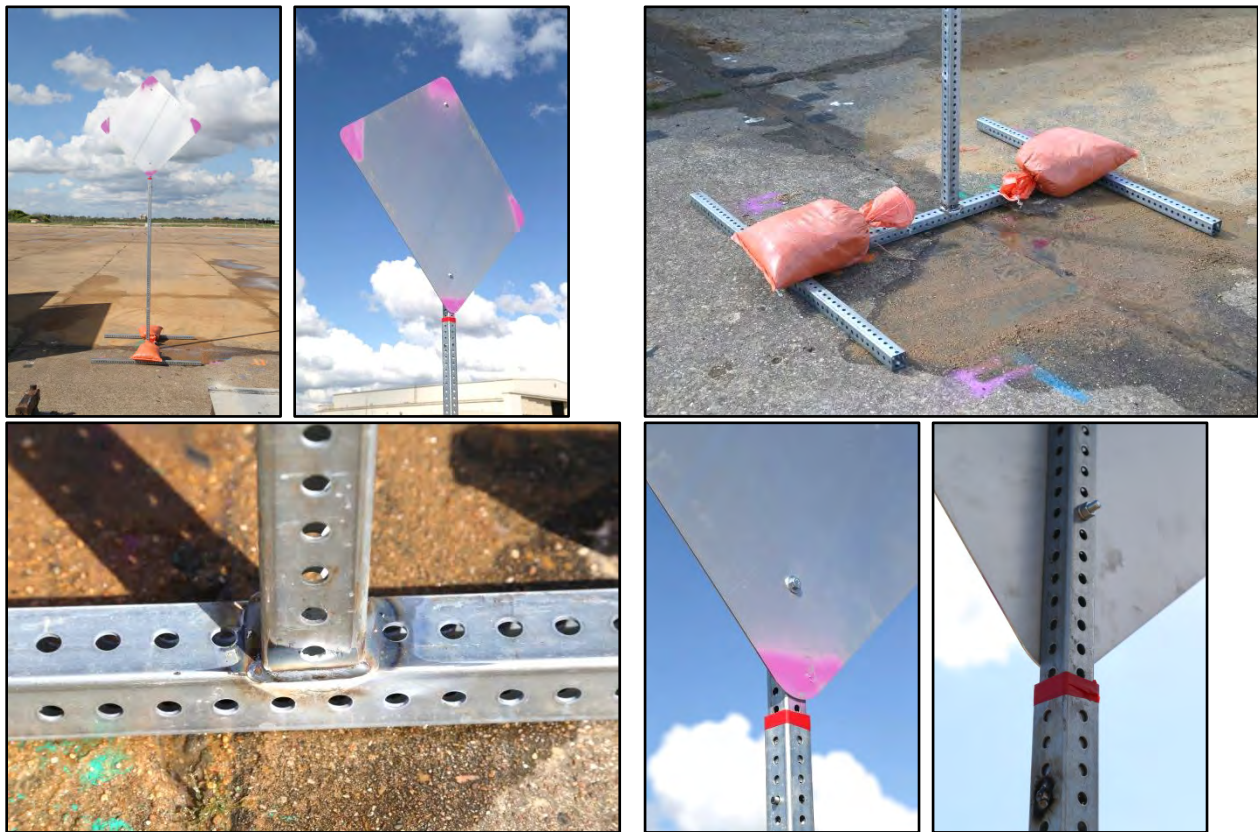

Figure 7.14. Option C Temporary Work Zone Sign Support Used for Test No. 490026-2-7.

7.4.2 Weather Conditions

The test was performed on the afternoon of March 11, 2016. Weather conditions at the time of testing were as follows: wind speed: 6 mi/h; wind direction: 163 degrees with respect to the vehicle (vehicle was traveling in a northerly direction); temperature: 76°F; relative humidity: 63 percent.

7.4.3 Test Vehicle

The 2011 Kia Rio used in the tests 490026-2-4 and 2-5, shown in Figure 7.15, was used for the crash test. The vehicle's test inertia weight was 2443 lb, and its gross static weight was 2608 lb. The height to the lower edge of the vehicle bumper was 8.0 inches, and the height to the upper edge of the vehicle bumper was 21.5 inches. Table H.1 in Appendix H1 gives additional dimensions and information on the vehicle. The vehicle was directed into the installation using the cable reverse tow and guidance system, and was released to be freewheeling and unrestrained just prior to impact.



Figure 7.15. Test Vehicle before Test No. 490026-2-7.

7.4.4 Test Description

The 2011 Kia Rio, traveling at an impact speed of 61.9 mi/h, contacted the Option C temporary work zone sign support 10 inches to the left of centerline of the vehicle at an impact angle of 0 degrees. At 0.003 s after impact, the base of the support began to lift off the concrete pavement and slide in front of the vehicle. The upper section of the support began to separate from the lower section at 0.008 s, and the lower section fractured at bumper height at 0.012 s. At 0.021 s, the upper section of the support lost contact with the lower section, and the lower section lost contact with the vehicle at 0.099 s. The vehicle was traveling at a speed of 59.8 mi/h. Brakes on the vehicle were applied after loss of contact with the support and came to rest 480 ft downstream and 19 ft to the left of centerline of the impact path. Figure H.1 in Appendix H2 presents sequential photographs during the test.

7.4.5 Damage to Test Installation

Figure 7.16 shows the damage to the Option C temporary work zone sign support. The sign panel and attached upper section of the vertical support came to rest 2 ft downstream of impact and 2 ft to the left of centerline of the vehicle path. The lower portion of the temporary work zone sign support came to rest 143 ft downstream of impact and 9 ft to the right of centerline of the impact path, and was deformed 85 degrees. A piece of the vertical section fractured away from the lower support 18 inches above ground level, and came to rest 275 ft downstream of impact and 18 ft to the right of centerline of the vehicle path.

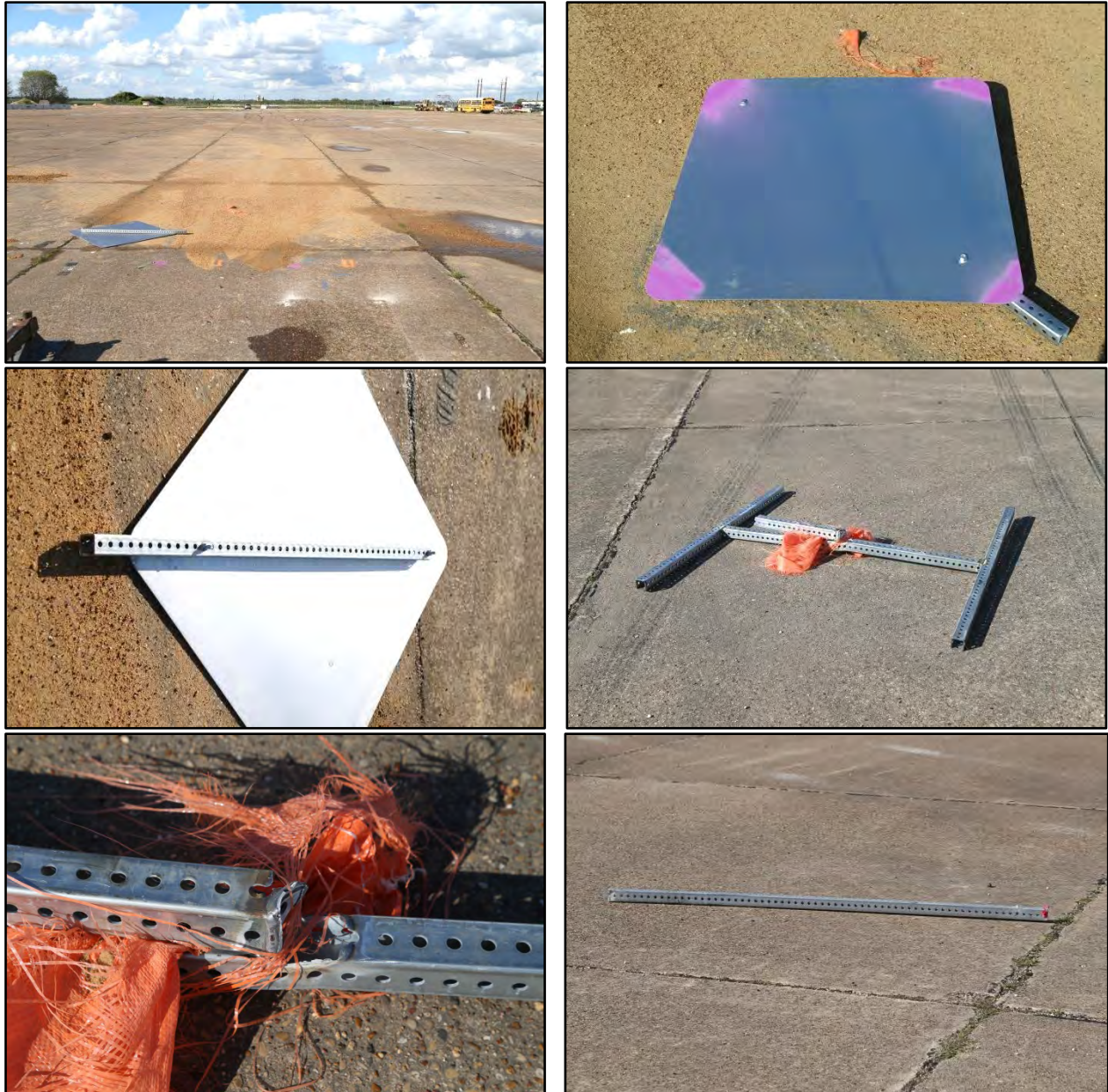

Figure 7.16. Option C Temporary Work Zone Sign Support after Test No. 490026-2-7.

7.4.6 Vehicle Damage

Figure 7.17 shows the damage sustained by the vehicle. The 1100C vehicle sustained only scrapes to the bumper and hood with no measureable exterior vehicle deformation. Figure 7.18 shows the interior of the vehicle. No occupant compartment deformation or intrusion was noted. Tables H.2 and H.3 in Appendix H1 provides exterior crush and occupant compartment measurements.



Figure 7.17. Test Vehicle after Test No. 490026-2-7.



Figure 7.18. Interior of Test Vehicle for Test No. 490026-2-7.

7.4.7 Occupant Risk Factors

No accelerometer or other types of instrumentation were installed in the vehicle. *MASH* states that Test 3-71 “can be conducted without the instrumentation necessary for determining occupant risk whenever the test article has a total weight of 220 lb or less. In this

case, vehicle intrusion, windshield damage, and vehicle stability are the primary performance evaluation factors.” The weight of the temporary work zone sign support system was 57 lb.

7.4.8 Assessment of Test Results

An assessment of the test based on the applicable *MASH* safety evaluation criteria for *MASH* test 3-71 is provided below.

7.4.8.1 Structural Adequacy

- B. The test article should readily activate in a predictable manner by breaking away, fracturing, or yielding.*

Results: The Option C temporary work zone sign support readily activated by yielding to the 1100C vehicle and releasing and fracturing. (PASS)

7.4.8.2 Occupant Risk

- D. Detached elements, fragments, or other debris from the test article should not penetrate or show potential for penetrating the occupant compartment, or present an undue hazard to other traffic, pedestrians, or personnel in a work zone.*

Deformation of, or intrusions into, the occupant compartment should not exceed limits set forth in Section 5.3 and Appendix E of MASH (roof ≤ 4.0 inches; windshield = ≤ 3.0 inches; side windows = no shattering by test article structural member; wheel/foot well/toe pan ≤ 9.0 inches; forward of A-pillar ≤ 12.0 inches; front side door area above seat ≤ 9.0 inches; front side door below seat ≤ 12.0 inches; floor pan/transmission tunnel area ≤ 12.0 inches).

Results: The Option C temporary work zone sign support released and fractured into three pieces; however, there was no concern for penetration or intrusion into the vehicle. The lower portion of the sign support rode along with the 1100C vehicle for a distance and came to rest 275 ft downstream of impact and 18 ft to the right of centerline of the vehicle path. (PASS)

No occupant compartment deformation or intrusion was noted. (PASS)

- E. Detached element, fragments or other debris from the test article, or vehicular damage should not block the driver’s vision or otherwise cause the driver to lose control of the vehicle.*

Results: The fractured pieces of the Option C temporary work zone sign support did not block the driver’s view or otherwise cause the driver to lose control of the 1100C vehicle. (PASS)

F. *The vehicle should remain upright during and after collision. The maximum roll and pitch angles are not to exceed 75 degrees.*

Results: The 1100C vehicle remained upright during and after the collision event. (PASS)

H. *Occupant impact velocities should satisfy the following:*

Longitudinal and Lateral Occupant Impact Velocity

<u><i>Preferred</i></u>	<u><i>Maximum</i></u>
<i>10 ft/s</i>	<i>16.4 ft/s</i>

Results: Assessment of occupant risk factors is not required for test articles having a total weight of 220 lb or less. (NA)

I. *Occupant ridedown accelerations should satisfy the following:*

Longitudinal and Lateral Occupant Ridedown Accelerations

<u><i>Preferred</i></u>	<u><i>Maximum</i></u>
<i>15 G</i>	<i>20.49 G</i>

Results: Assessment of occupant risk factors is not required for test articles having a total weight of 220 lb or less. (NA)

7.4.8.3 Vehicle Trajectory

N. *Vehicle trajectory behind the test article is acceptable.*

Results: The 1100C vehicle came to rest 480 ft behind the original position of the Option C temporary work zone sign support. (PASS)

7.4.9 Conclusions

Figure 7.19 provides a summary of the results of the test. The slip connection of Option C temporary work zone sign support performed as designed and the top of the system released from the lower section. The support structure contacted the bumper and hood, but the sign panel did not contact the roof of the vehicle.

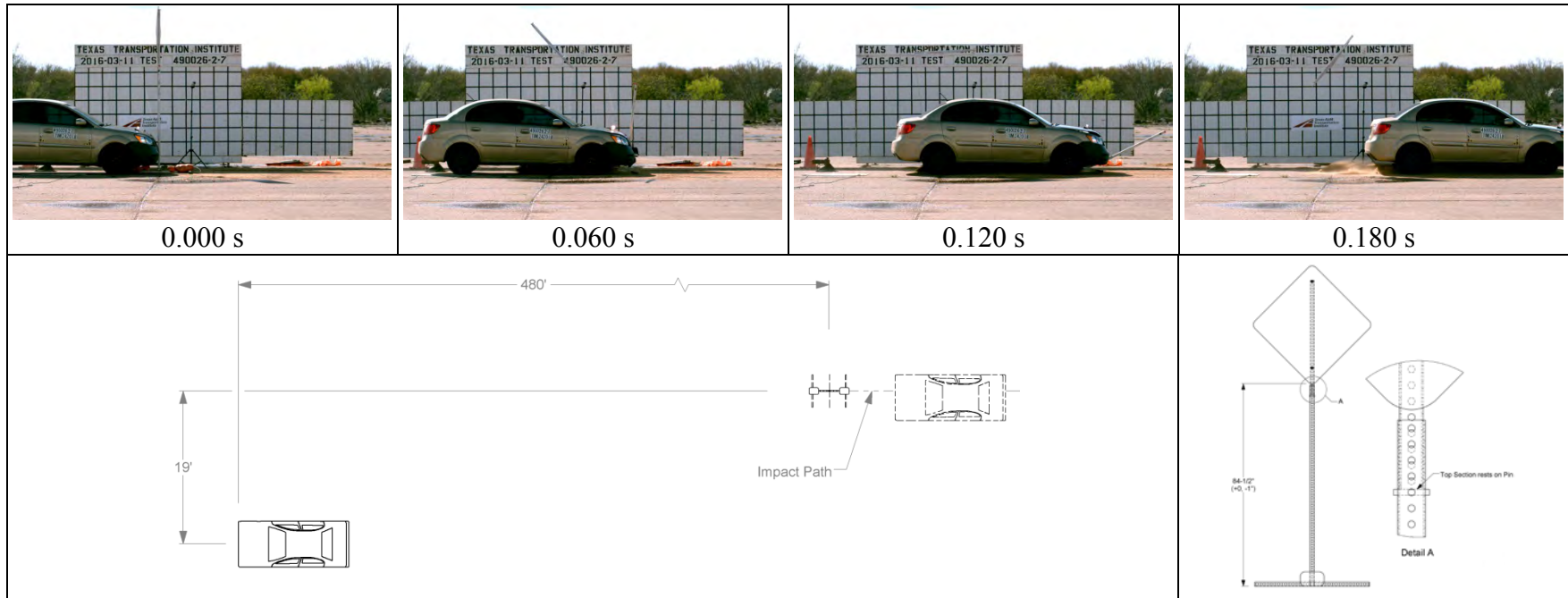

General Information

Test Agency..... Texas A&M Transportation Institute (TTI)
 Test Standard Test No..... MASH Test 3-71
 TTI Test No. 490026-2-7
 Test Date..... 2016-03-11

Test Article

Type Temporary Work Zone Sign Support
 Name..... Option C Temporary Work Zone Sign Support
 Installation Height 84 1/2 inches to bottom; 133 3/8 to top
 Material or Key Elements Upper section inserted 4 9/32 inches into the lower 1 3/4-inch square tubing post and rested on a 3/8-inch diameter x 2 1/4-inch long smooth pin located in holes 4 1/2 inches below the top of post

Soil Type and Condition Placed on dry concrete surface

Test Vehicle

Type/Designation1100C
 Make and Model.....2011 Kia Rio
 Curb2479 lb
 Test Inertial2443 lb
 Dummy.....165 lb
 Gross Static.....2608 lb

Impact Conditions

Speed.....61.9 mi/h
 Angle.....0 degrees
 Location/Orientation10 inches left of centerline

Kinetic Energy311 kip-ft

Exit Conditions

Speed.....59.8 mi/h
 Angle.....NA

Occupant Risk Values Assessment of occupant risk factors not required for test articles of 57 lb

Test Article Debris Scatter

Longitudinal275 downstream
 Lateral.....18 ft right – 2 ft left

Post-Impact Trajectory

Stopping Distance.....480 ft downstream
 19 ft left of center

Vehicle Stability

Maximum Yaw Angle Vehicle
 Maximum Pitch Angle remained
 Maximum Roll Angle upright
 Vehicle Snagging No
 Vehicle Pocketing No

Vehicle Damage

VDS 12FL1
 CDC..... 12FLEN1
 Max. Exterior Deformation.....None
 OCDI.....LF0000000
 Max. Occupant Compartment Deformation.....None

Figure 7.19. Summary of Results for MASH Test 3-71 at 0 Degrees on the Option C Temporary Work Zone Sign Support.

7.5 MASH TEST 3-72 AT 0 DEGREES (CRASH TEST NO. 490026-2-9)

7.5.1 Test Designation and Actual Impact Conditions

MASH Test 3-72 involves a 2270P vehicle weighing 5000 lb \pm 110 lb impacting the Option C temporary work zone sign support at an impact speed of 62.2 mi/h \pm 2.5 mi/h and CIA \pm 1.5 degrees. The CIA for MASH Test 3-72 on the temporary work zone sign support was 0 degrees. The 2010 Dodge Ram 1500 pickup truck used in the test weighed 5014 lb, and the actual impact speed and angle were 62.9 mi/h and 0 degrees, respectively. The actual impact point was 10 inches to the left of centerline of the vehicle. The target KE was \geq 594 kip-ft, and the actual KE at impact was 663 kip-ft. Figure 7.20 shows the installation before the test.

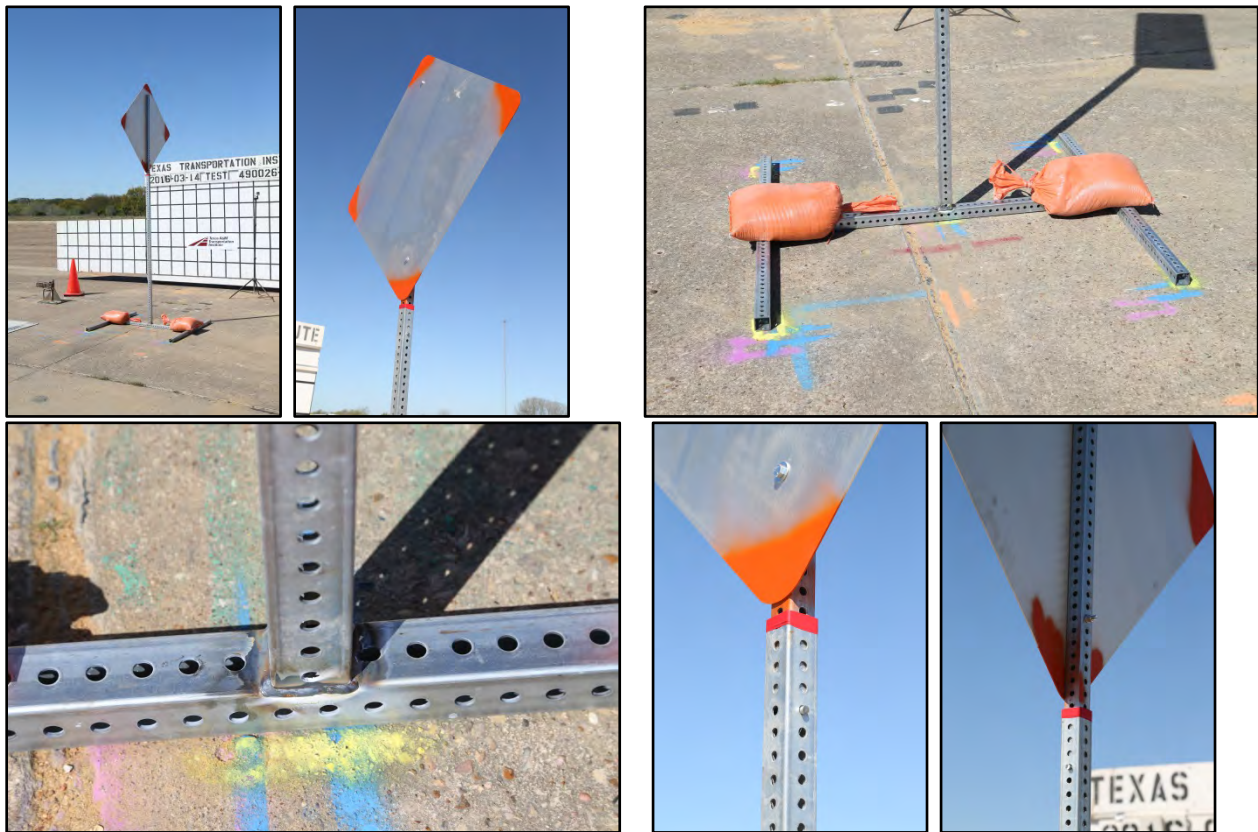

Figure 7.20. Option C Temporary Work Zone Sign Support Used for Test No. 490026-2-9.

7.5.2 Weather Conditions

The test was performed at noon on March 14, 2016. Weather conditions at the time of testing were as follows: wind speed: 9 mi/h; wind direction: 209 degrees with respect to the vehicle (vehicle was traveling in a northerly direction); temperature: 80°F; relative humidity: 43 percent.

7.5.3 Test Vehicle

The 2010 Dodge Ram 1500 pickup, shown in Figure 7.21, was used for the crash test. The vehicle's test inertia weight was 5014 lb, and its gross static weight was 5014 lb. The height to the lower edge of the vehicle bumper was 12.5 inches, and the height to the upper edge of the vehicle bumper was 27.5 inches. The height to the vehicle's center of gravity was 28.4 inches. Tables I.1 and I.2 in Appendix I1 give additional dimensions and information on the vehicle. The vehicle was directed into the installation using a cable reverse tow and guidance system, and was released to be freewheeling and unrestrained just prior to impact.



Figure 7.21. Test Vehicle before Test No. 490026-2-9.

7.5.4 Test Description

The 2010 Dodge Ram 1500 pickup, traveling at an impact speed of 62.9 mi/h, contacted the Option C temporary work zone sign support 10 inches to the left of centerline of the vehicle at an impact angle of 0 degrees. At 0.003 s, the support contacted the upper grill of the vehicle, and at 0.006 s, the base of the support began to lift off the concrete pavement and slide along the surface. The upper section of the support began to pull out of the lower section at 0.007 s, and the lower section of the support fractured at bumper height at 0.009 s. At 0.020 s, the upper section of the support lost contact with the lower section, and at 0.078 s, the vehicle lost contact with the support. The vehicle was traveling at a speed of 61.9 mi/h at loss of contact. Brakes on the vehicle were applied after loss of contact with the sign panel, and the vehicle came to rest 405 ft downstream of impact and 6 ft to the left of centerline of the impact path. Figure I.1 in Appendix I2 presents sequential photographs during the test.

7.5.5 Damage to Test Installation

Figure 7.22 shows the damage to the Option C temporary work zone sign support. The sign panel and the attached upper section of the vertical support came to rest 7 ft downstream of impact. A vertical piece fractured from the lower section of the support at 24 inches above ground and came to rest 125 ft downstream of impact. The remainder of the temporary work zone sign support came to rest 120 ft downstream of impact and 10 ft to the right of centerline of the impact path.



Figure 7.22. Option C Temporary Work Zone Sign Support after Test No. 490026-2-9.

7.5.6 Vehicle Damage

Figure 7.23 shows the damage sustained by the vehicle. The bumper and hood were scraped. Maximum exterior crush to the vehicle was 3.5 inches in the front plane at the left quarter point at bumper height. Figure 7.24 shows the interior of the vehicle. No occupant compartment deformation or intrusion was noted. Tables I.3 and I.4 in Appendix I1 provides exterior crush and occupant compartment measurements.



Figure 7.23. Test Vehicle after Test No. 490026-2-9.

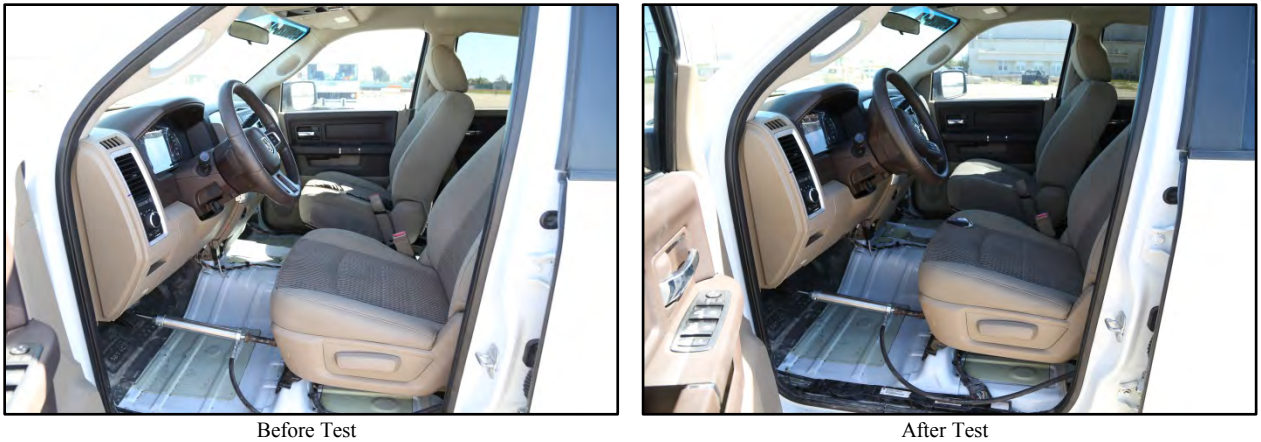

Figure 7.24. Interior of Test Vehicle for Test No. 490026-2-9.

7.5.7 Occupant Risk Factors

No accelerometer or other types of instrumentation were installed in the vehicle. *MASH* states that Test 3-71 “can be conducted without the instrumentation necessary for determining occupant risk whenever the test article has a total weight of 220 lb or less. In this case, vehicle intrusion, windshield damage, and vehicle stability are the primary performance evaluation factors.” The weight of the temporary work zone sign support system was 57 lb.

7.5.8 Assessment of Test Results

An assessment of the test based on the applicable *MASH* safety evaluation criteria for *MASH* test 3-72 is provided below.

7.5.8.1 Structural Adequacy

- B. The test article should readily activate in a predictable manner by breaking away, fracturing, or yielding.*

Results: The Option C temporary work zone sign support readily activated by yielding to the 2270P vehicle and releasing and fracturing. (PASS)

7.5.8.2 Occupant Risk

D. *Detached elements, fragments, or other debris from the test article should not penetrate or show potential for penetrating the occupant compartment, or present an undue hazard to other traffic, pedestrians, or personnel in a work zone.*

Deformation of, or intrusions into, the occupant compartment should not exceed limits set forth in Section 5.3 and Appendix E of MASH (roof ≤ 4.0 inches; windshield = ≤ 3.0 inches; side windows = no shattering by test article structural member; wheel/foot well/toe pan ≤ 9.0 inches; forward of A-pillar ≤ 12.0 inches; front side door area above seat ≤ 9.0 inches; front side door below seat ≤ 12.0 inches; floor pan/transmission tunnel area ≤ 12.0 inches).

Results: The Option C temporary work zone sign support released and fractured into three pieces; however, there was no concern for penetration or intrusion into the vehicle. The lower portion of the sign support lodged under the truck and traveled with the vehicle. (PASS)

No occupant compartment deformation or intrusion was noted. (PASS)

E. *Detached element, fragments or other debris from the test article, or vehicular damage should not block the driver's vision or otherwise cause the driver to lose control of the vehicle.*

Results: The released and fractured pieces of the Option C temporary work zone sign support did not block the driver's view or otherwise cause the driver to lose control of the 2270P vehicle. (PASS)

F. *The vehicle should remain upright during and after collision. The maximum roll and pitch angles are not to exceed 75 degrees.*

Results: The 2270P vehicle remained upright during and after the collision event. (PASS)

H. *Occupant impact velocities should satisfy the following:*

Longitudinal and Lateral Occupant Impact Velocity

<u><i>Preferred</i></u>	<u><i>Maximum</i></u>
<i>10 ft/s</i>	<i>16.4 ft/s</i>

Results: Assessment of occupant risk factors is not required for test articles having a total weight of 220 lb or less. (NA)

I. *Occupant ridedown accelerations should satisfy the following:*
Longitudinal and Lateral Occupant Ridedown Accelerations

<u>Preferred</u>	<u>Maximum</u>
15 G	20.49 G

Results: Assessment of occupant risk factors is not required for test articles having a total weight of 220 lb or less. (NA)

7.5.8.3 Vehicle Trajectory

N. *Vehicle trajectory behind the test article is acceptable.*

Results: The 2270P vehicle came to rest 405 ft behind the Option C temporary work zone sign support. (PASS)

7.5.9 Conclusions

Figure 7.25 provides a summary of the results of the test. The slip connection for Option C temporary work zone sign support performed as designed, and the top of the system released from the lower section at vehicle impact. The released and fractured pieces gave no concern for penetration or intrusion into the vehicle. The sign panel did not contact the roof. The 2270P vehicle remained upright during and after the collision event. The 2270P vehicle came to rest 405 ft behind the Option C temporary work zone sign support.

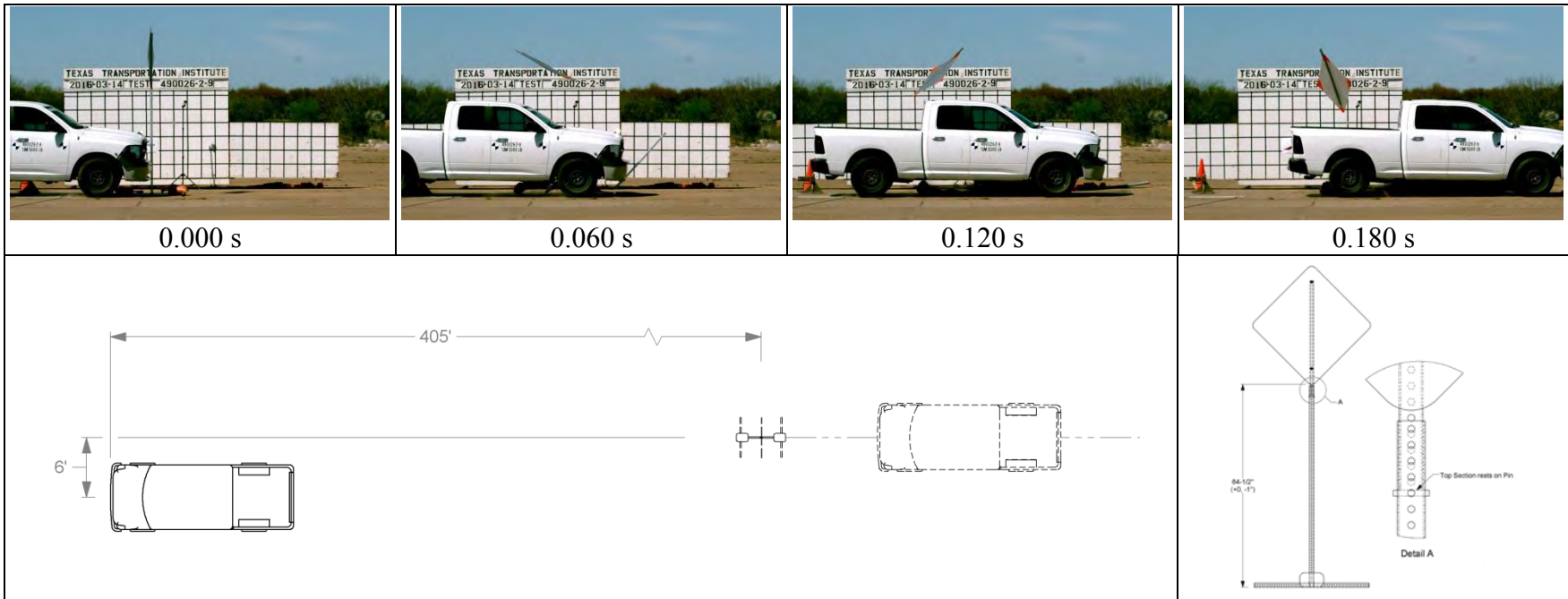

General Information

Test Agency..... Texas A&M Transportation Institute (TTI)
 Test Standard Test No..... MASH Test 3-72
 TTI Test No. 490026-2-9
 Test Date 2016-03-14

Test Article

Type Temporary Work Zone Sign Support
 Name..... Option C Temporary Work Zone Sign Support
 Installation Height 84½ inches to bottom; 133¾ to top
 Material or Key Elements Upper section inserted 4⁹/₃₂ inches into the lower 1¾-inch square tubing post and rested on a ¾-inch diameter × 2¼-inch long smooth pin located in holes 4½ inches below the top of post

Soil Type and Condition Placed on dry concrete surface

Test Vehicle

Type/Designation2270P
 Make and Model.....2010 Dodge Ram 1500
 Curb4898 lb
 Test Inertial5014 lb
 Dummy.....No dummy
 Gross Static.....5014 lb

Impact Conditions

Speed.....62.9 mi/h
 Angle.....0 degrees
 Location/Orientation10 inches left of centerline

Kinetic Energy663 kip-ft

Exit Conditions

Speed.....61.9 mi/h
 Angle.....NA

Occupant Risk Values Assessment of occupant risk factors not required for test articles of 57 lb

Test Article Debris Scatter

Longitudinal 120 downstream
 Lateral..... 10 ft right of center

Post-Impact Trajectory

Stopping Distance405 ft downstream
 6 ft left of center

Vehicle Stability

Maximum Yaw Angle Vehicle
 Maximum Pitch Angle remained
 Maximum Roll Angle upright
 Vehicle Snagging No
 Vehicle Pocketing No

Vehicle Damage

VDS 12FL1
 CDC..... 12FLEN1
 Max. Exterior Deformation.....3.5 inches
 OCDI.....FR000000
 Max. Occupant Compartment DeformationNone

Figure 7.25. Summary of Results for MASH Test 3-72 at 0 Degrees on the Option C Temporary Work Zone Sign Support.

Chapter 8. SUMMARY AND CONCLUSIONS

8.1 ASSESSMENT OF TEST RESULTS

8.1.1 Option A Temporary Work Zone Sign Support

During *MASH* Test 3-72 at 90 degrees, the slip connection of the Option A temporary work zone sign support performed as designed and the top of the system released from the lower section at vehicle impact. The corner of the sign panel impacted the vehicle roof, and no tear occurred during this first impact. However, as the vehicle continued forward, the sign panel continued to rotate and impacted the rear of the roof causing a 5-inch long tear in the exterior of the roof. The tear did not extend into the occupant compartment, but did cause a 1-inch dent in the interior roof of the right rear passenger compartment. Due to this tear, the Option A temporary work zone sign support was judged to have potential for intrusion into the occupant compartment. Therefore, the Option A temporary work zone sign support was deemed not to meet the criteria for *MASH* Test 3-72, and additional testing was not performed.

8.1.2 Option B Temporary Work Zone Sign Support

During *MASH* Test 3-72 at 90 degrees, the slip connection of Option B temporary work zone sign support performed as designed and the top of the system released from the lower section at vehicle impact. The fuse plate activated as designed. The sign panel impacted the roof; however, it did not cause any tears. The slight roof deformation was within *MASH* criteria.

The slip connection of Option B temporary work zone sign supports performed as designed and the top of the system released from the lower section at vehicle impact during *MASH* Test 3-72 at 0 degrees. The Option B temporary work zone sign support did not penetrate or show signs for potential penetration of the vehicle. No occupant compartment deformation or intrusion was noted. The released and fractured pieces of the Option B temporary work zone sign support did not block the driver's view or otherwise cause the driver to lose control of the 2270P vehicle. The 2270P vehicle remained upright during and after the collision event. The 2270P vehicle came to rest 409 ft behind the installation.

The slip connection of Option B temporary work zone sign support performed as designed and the top of the system released from the lower section at vehicle impact during *MASH* Test 3-71 at 90 degrees. The fuse plate activated as designed. The support structure contacted the bumper and hood, but the sign panel did not contact the roof of the vehicle.

During *MASH* Test 3-71 at 0 degrees, the slip connection of Option B temporary work zone sign support performed as designed and the top of the system released from the lower section at vehicle impact. The support structure contacted the bumper and hood, but the sign panel did not contact the roof of the vehicle.

8.1.3 Option C Temporary Work Zone Sign Support

During *MASH* Test 3-72, the slip connection for Option C temporary work zone sign support performed as designed and the top of the system released from the lower section at

vehicle impact. The sign panel contacted the roof; however, it did not cause any tears. The resulting roof deformation was minor and within *MASH* criteria.

The slip connection for Option C temporary work zone sign support performed as designed and the top of the system released from the lower section at vehicle impact during *MASH* Test 3-72. The released and fractured pieces gave no concern for penetration or intrusion into the vehicle. The sign panel did not contact the roof. The 2270P vehicle remained upright during and after the collision event. The 2270P vehicle came to rest 405 ft behind the Option C temporary work zone sign support.

The slip connection of Option C temporary work zone sign support performed as designed and the top of the system released from the lower section at vehicle impact during *MASH* Test 3-71 at 90 degrees. The support structure contacted the bumper and hood, but the sign panel did not contact the roof of the vehicle.

During *MASH* Test 3-71 at 0 degrees, the slip connection of Option C temporary work zone sign support performed as designed and the top of the system released from the lower section at vehicle impact. The support structure contacted the bumper and hood, but the sign panel did not contact the roof of the vehicle.

8.2 CONCLUSIONS

Table 8.1 shows that the Option A temporary work zone sign support did not perform acceptably for *MASH* Test 3-72 at 90 degrees. Due to a tear in the roof of the 2270P vehicle, the Option A temporary work zone sign support was judged to have potential for intrusion into the occupant compartment.

Tables 8.2 through 8.5 show that the Option B temporary work zone sign support functioned acceptably in all four *MASH* tests performed.

Tables 8.6 through 8.9 show that the Option C temporary work zone sign support performed acceptably in all four *MASH* tests performed.

Table 8.1. Performance Evaluation Summary for MASH Test 3-72 at 90 Degrees on the Option A Temporary Work Zone Sign Support.

Test Agency: Texas A&M Transportation Institute

Test No.: 490026-2-1

Test Date: 2016-03-03

MASH Test 3-72 Evaluation Criteria	Test Results	Assessment
Structural Adequacy		
<i>B. The test article should readily activate in a predictable manner by breaking away, fracturing, or yielding.</i>	The Option A temporary work zone sign support readily activated by yielding to the 2270P vehicle.	Pass
Occupant Risk		
<i>D. Detached elements, fragments, or other debris from the test article should not penetrate or show potential for penetrating the occupant compartment, or present an undue hazard to other traffic, pedestrians, or personnel in a work zone.</i>	The sign panel and a portion of the upright contacted the roof of the 2270P vehicle causing a 16-inch long scratch that ended in a 5-inch long cut on the outer surface of the rear cab. This was determined to be of concern for potential intrusion into the vehicle.	Fail
<i>Deformations of, or intrusions into, the occupant compartment should not exceed limits set forth in Section 5.3 and Appendix E of MASH.</i>	The interior roof in the area of the 5-inch cut did not penetrate the occupant compartment, but the interior was dented inward approximately 1 inch. No other occupant compartment deformation or intrusion was noted.	Pass
<i>E. Detached elements, fragments, or other debris from the test article, of vehicular damage should not block the driver's vision or otherwise cause the driver to lose control of the vehicle.</i>	The fractured pieces of the Option A temporary work zone sign support did not block the driver's view or otherwise cause the driver to lose control of the 2270P vehicle.	Pass
<i>F. The vehicle should remain upright during and after collision. The maximum roll and pitch angles are not to exceed 75 degrees.</i>	The 2270P vehicle remained upright during and after the collision event.	Pass
<i>H. Longitudinal and lateral occupant impact velocities should fall below the preferred value of 10 ft/s, or at least below the maximum allowable value of 16.4 ft/s.</i>	Assessment of occupant risk factors is not required for test articles having a total weight of 220 lb or less.	NA
<i>I. Longitudinal and lateral occupant ridedown accelerations should fall below the preferred value of 15.0 Gs, or at least below the maximum allowable value of 20.49 Gs.</i>	The weight of the Option A temporary work zone sign support system was 60 lb.	NA
Vehicle Trajectory		
<i>N. Vehicle trajectory behind the test article is acceptable.</i>	The 2270P vehicle came to rest 280 ft behind the Option A temporary work zone sign support.	Pass

Table 8.2. Performance Evaluation Summary for MASH Test 3-72 at 90 Degrees on the Option B Temporary Work Zone Sign Support.

Test Agency: Texas A&M Transportation Institute

Test No.: 490026-2-2

Test Date: 2016-03-03

MASH Test 3-72 Evaluation Criteria	Test Results	Assessment
Structural Adequacy		
<i>B. The test article should readily activate in a predictable manner by breaking away, fracturing, or yielding.</i>	The Option B temporary work zone sign support readily activated by yielding to the 2270P vehicle.	Pass
Occupant Risk		
<i>D. Detached elements, fragments, or other debris from the test article should not penetrate or show potential for penetrating the occupant compartment, or present an undue hazard to other traffic, pedestrians, or personnel in a work zone.</i>	The Option B temporary work zone sign support fractured into several pieces; however, there was no concern for potential deformation or intrusion into the vehicle.	Pass
<i>Deformations of, or intrusions into, the occupant compartment should not exceed limits set forth in Section 5.3 and Appendix E of MASH.</i>	No occupant compartment deformation or intrusion was noted.	Pass
<i>E. Detached elements, fragments, or other debris from the test article, of vehicular damage should not block the driver's vision or otherwise cause the driver to lose control of the vehicle.</i>	The fractured pieces of the Option B temporary work zone sign support did not block the driver's view or otherwise cause the driver to lose control of the 2270P vehicle.	Pass
<i>F. The vehicle should remain upright during and after collision. The maximum roll and pitch angles are not to exceed 75 degrees.</i>	The 2270P vehicle remained upright during and after the collision event.	Pass
<i>H. Longitudinal and lateral occupant impact velocities should fall below the preferred value of 10 ft/s, or at least below the maximum allowable value of 16.4 ft/s.</i>	Assessment of occupant risk factors is not required for test articles having a total weight of 220 lb or less.	NA
<i>I. Longitudinal and lateral occupant ridedown accelerations should fall below the preferred value of 15.0 Gs, or at least below the maximum allowable value of 20.49 Gs.</i>	The weight of the Option B temporary work zone sign support system was 58 lb.	NA
Vehicle Trajectory		
<i>N. Vehicle trajectory behind the test article is acceptable.</i>	The 2270P vehicle came to rest 305 ft behind the Option B temporary work zone sign support.	Pass

Table 8.3. Performance Evaluation Summary for MASH Test 3-71 at 90 Degrees on the Option B Temporary Work Zone Sign Support.

Test Agency: Texas A&M Transportation Institute

Test No.: 490026-2-4

Test Date: 2016-03-11

MASH Test 3-71 Evaluation Criteria	Test Results	Assessment
Structural Adequacy		
<i>B. The test article should readily activate in a predictable manner by breaking away, fracturing, or yielding.</i>	The Option B temporary work zone sign support readily activated by yielding to the 1100C vehicle.	Pass
Occupant Risk		
<i>D. Detached elements, fragments, or other debris from the test article should not penetrate or show potential for penetrating the occupant compartment, or present an undue hazard to other traffic, pedestrians, or personnel in a work zone.</i>	The Option B temporary work zone sign support fractured into several pieces; however, there was no concern for potential deformation or intrusion into the vehicle.	Pass
<i>Deformations of, or intrusions into, the occupant compartment should not exceed limits set forth in Section 5.3 and Appendix E of MASH.</i>	No occupant compartment deformation or intrusion was noted.	Pass
<i>E. Detached elements, fragments, or other debris from the test article, of vehicular damage should not block the driver's vision or otherwise cause the driver to lose control of the vehicle.</i>	The fractured pieces of the Option B temporary work zone sign support did not block the driver's view or otherwise cause the driver to lose control of the 1100C vehicle.	Pass
<i>F. The vehicle should remain upright during and after collision. The maximum roll and pitch angles are not to exceed 75 degrees.</i>	The 1100C vehicle remained upright during and after the collision event.	Pass
<i>H. Longitudinal and lateral occupant impact velocities should fall below the preferred value of 10 ft/s, or at least below the maximum allowable value of 16.4 ft/s.</i>	Assessment of occupant risk factors is not required for test articles having a total weight of 220 lb or less.	NA
<i>I. Longitudinal and lateral occupant ridedown accelerations should fall below the preferred value of 15.0 Gs, or at least below the maximum allowable value of 20.49 Gs.</i>	The weight of the Option B temporary work zone sign support system was 58 lb.	NA
Vehicle Trajectory		
<i>N. Vehicle trajectory behind the test article is acceptable.</i>	The 1100C vehicle came to rest 468 ft behind the Option B temporary work zone sign support.	Pass

Table 8.4. Performance Evaluation Summary for MASH Test 3-71 at 0 Degrees on the Option B Temporary Work Zone Sign Support.

Test Agency: Texas A&M Transportation Institute

Test No.: 490026-2-6

Test Date: 2016-03-11

MASH Test 3-71 Evaluation Criteria	Test Results	Assessment
Structural Adequacy		
<i>B. The test article should readily activate in a predictable manner by breaking away, fracturing, or yielding.</i>	The Option B temporary work zone sign support readily activated by yielding to the 1100C vehicle.	Pass
Occupant Risk		
<i>D. Detached elements, fragments, or other debris from the test article should not penetrate or show potential for penetrating the occupant compartment, or present an undue hazard to other traffic, pedestrians, or personnel in a work zone.</i>	The Option B temporary work zone sign support fractured into several pieces; however, there was no concern for potential deformation or intrusion into the vehicle.	Pass
<i>Deformations of, or intrusions into, the occupant compartment should not exceed limits set forth in Section 5.3 and Appendix E of MASH.</i>	No occupant compartment deformation or intrusion was noted.	Pass
<i>E. Detached elements, fragments, or other debris from the test article, of vehicular damage should not block the driver's vision or otherwise cause the driver to lose control of the vehicle.</i>	The fractured pieces of the Option B temporary work zone sign support did not block the driver's view or otherwise cause the driver to lose control of the 1100C vehicle.	Pass
<i>F. The vehicle should remain upright during and after collision. The maximum roll and pitch angles are not to exceed 75 degrees.</i>	The 1100C vehicle remained upright during and after the collision event.	Pass
<i>H. Longitudinal and lateral occupant impact velocities should fall below the preferred value of 10 ft/s, or at least below the maximum allowable value of 16.4 ft/s.</i>	Assessment of occupant risk factors is not required for test articles having a total weight of 220 lb or less.	NA
<i>I. Longitudinal and lateral occupant ridedown accelerations should fall below the preferred value of 15.0 Gs, or at least below the maximum allowable value of 20.49 Gs.</i>	The weight of the Option B temporary work zone sign support system was 58 lb.	NA
Vehicle Trajectory		
<i>N. Vehicle trajectory behind the test article is acceptable.</i>	The 1100C vehicle came to rest 500 ft behind the Option B temporary work zone sign support.	Pass

Table 8.5. Performance Evaluation Summary for MASH Test 3-72 at 0 Degrees on the Option B Temporary Work Zone Sign Support.

Test Agency: Texas A&M Transportation Institute

Test No.: 490026-2-8

Test Date: 2016-03-14

MASH Test 3-72 Evaluation Criteria	Test Results	Assessment
Structural Adequacy		
<i>B. The test article should readily activate in a predictable manner by breaking away, fracturing, or yielding.</i>	The Option B temporary work zone sign support readily activated by yielding to the 2270P vehicle.	Pass
Occupant Risk		
<i>D. Detached elements, fragments, or other debris from the test article should not penetrate or show potential for penetrating the occupant compartment, or present an undue hazard to other traffic, pedestrians, or personnel in a work zone.</i>	The Option B temporary work zone sign support fractured but did not penetrate or show signs for potential penetration of the vehicle.	Pass
<i>Deformations of, or intrusions into, the occupant compartment should not exceed limits set forth in Section 5.3 and Appendix E of MASH.</i>	No occupant compartment deformation or intrusion was noted.	Pass
<i>E. Detached elements, fragments, or other debris from the test article, of vehicular damage should not block the driver's vision or otherwise cause the driver to lose control of the vehicle.</i>	The fractured pieces of the Option B temporary work zone sign support did not block the driver's view or otherwise cause the driver to lose control of the 2270P vehicle.	Pass
<i>F. The vehicle should remain upright during and after collision. The maximum roll and pitch angles are not to exceed 75 degrees.</i>	The 2270P vehicle remained upright during and after the collision event.	Pass
<i>H. Longitudinal and lateral occupant impact velocities should fall below the preferred value of 10 ft/s, or at least below the maximum allowable value of 16.4 ft/s.</i>	Assessment of occupant risk factors is not required for test articles having a total weight of 220 lb or less.	NA
<i>I. Longitudinal and lateral occupant ridedown accelerations should fall below the preferred value of 15.0 Gs, or at least below the maximum allowable value of 20.49 Gs.</i>	The weight of the Option A temporary work zone sign support system was 58 lb.	NA
Vehicle Trajectory		
<i>N. Vehicle trajectory behind the test article is acceptable.</i>	The 2270P vehicle came to rest 409 ft behind the installation.	Pass

Table 8.6. Performance Evaluation Summary for MASH Test 3-72 at 90 Degrees on the Option C Temporary Work Zone Sign Support.

Test Agency: Texas A&M Transportation Institute

Test No.: 490026-2-3

Test Date: 2016-03-03

MASH Test 3-72 Evaluation Criteria	Test Results	Assessment
Structural Adequacy		
<i>B. The test article should readily activate in a predictable manner by breaking away, fracturing, or yielding.</i>	The Option C temporary work zone sign support readily activated by yielding to the 2270P vehicle.	Pass
Occupant Risk		
<i>D. Detached elements, fragments, or other debris from the test article should not penetrate or show potential for penetrating the occupant compartment, or present an undue hazard to other traffic, pedestrians, or personnel in a work zone.</i>	The Option C temporary work zone sign support fractured into several pieces; however, there was no concern for potential deformation or intrusion into the vehicle.	Pass
<i>Deformations of, or intrusions into, the occupant compartment should not exceed limits set forth in Section 5.3 and Appendix E of MASH.</i>	No occupant compartment deformation or intrusion was noted.	Pass
<i>E. Detached elements, fragments, or other debris from the test article, of vehicular damage should not block the driver's vision or otherwise cause the driver to lose control of the vehicle.</i>	The fractured pieces of the Option C temporary work zone sign support did not block the driver's view or otherwise cause the driver to lose control of the 2270P vehicle.	Pass
<i>F. The vehicle should remain upright during and after collision. The maximum roll and pitch angles are not to exceed 75 degrees.</i>	The 2270P vehicle remained upright during and after the collision event.	Pass
<i>H. Longitudinal and lateral occupant impact velocities should fall below the preferred value of 10 ft/s, or at least below the maximum allowable value of 16.4 ft/s.</i>	Assessment of occupant risk factors is not required for test articles having a total weight of 220 lb or less.	NA
<i>I. Longitudinal and lateral occupant ridedown accelerations should fall below the preferred value of 15.0 Gs, or at least below the maximum allowable value of 20.49 Gs.</i>	The weight of the Option C temporary work zone sign support system was 57 lb.	NA
Vehicle Trajectory		
<i>N. Vehicle trajectory behind the test article is acceptable.</i>	The 2270P vehicle came to rest 347 ft behind the Option C temporary work zone sign support.	Pass

Table 8.7. Performance Evaluation Summary for MASH Test 3-71 at 90 Degrees on the Option C Temporary Work Zone Sign Support.

Test Agency: Texas A&M Transportation Institute

Test No.: 490026-2-5

Test Date: 2016-03-11

MASH Test 3-71 Evaluation Criteria	Test Results	Assessment
Structural Adequacy		
<i>B. The test article should readily activate in a predictable manner by breaking away, fracturing, or yielding.</i>	The Option C temporary work zone sign support readily activated by yielding to the 1100C vehicle.	Pass
Occupant Risk		
<i>D. Detached elements, fragments, or other debris from the test article should not penetrate or show potential for penetrating the occupant compartment, or present an undue hazard to other traffic, pedestrians, or personnel in a work zone.</i>	The Option C temporary work zone sign support fractured into several pieces; however, there was no concern for potential deformation or intrusion into the vehicle.	Pass
<i>Deformations of, or intrusions into, the occupant compartment should not exceed limits set forth in Section 5.3 and Appendix E of MASH.</i>	No occupant compartment deformation or intrusion was noted.	Pass
<i>E. Detached elements, fragments, or other debris from the test article, of vehicular damage should not block the driver's vision or otherwise cause the driver to lose control of the vehicle.</i>	The fractured pieces of the Option C temporary work zone sign support did not block the driver's view or otherwise cause the driver to lose control of the 1100C vehicle.	Pass
<i>F. The vehicle should remain upright during and after collision. The maximum roll and pitch angles are not to exceed 75 degrees.</i>	The 1100C vehicle remained upright during and after the collision event.	Pass
<i>H. Longitudinal and lateral occupant impact velocities should fall below the preferred value of 10 ft/s, or at least below the maximum allowable value of 16.4 ft/s.</i>	Assessment of occupant risk factors is not required for test articles having a total weight of 220 lb or less.	NA
<i>I. Longitudinal and lateral occupant ridedown accelerations should fall below the preferred value of 15.0 Gs, or at least below the maximum allowable value of 20.49 Gs.</i>	The weight of the Option C temporary work zone sign support system was 57 lb.	NA
Vehicle Trajectory		
<i>N. Vehicle trajectory behind the test article is acceptable.</i>	The 1100C vehicle came to rest 500 ft behind the Option C temporary work zone sign support.	Pass

Table 8.8. Performance Evaluation Summary for MASH Test 3-71 at 0 Degrees on the Option C Temporary Work Zone Sign Support.

Test Agency: Texas A&M Transportation Institute

Test No.: 490026-2-7

Test Date: 2016-03-11

MASH Test 3-71 Evaluation Criteria	Test Results	Assessment
Structural Adequacy		
<i>B. The test article should readily activate in a predictable manner by breaking away, fracturing, or yielding.</i>	The Option C temporary work zone sign support readily activated by yielding to the 1100C vehicle.	Pass
Occupant Risk		
<i>D. Detached elements, fragments, or other debris from the test article should not penetrate or show potential for penetrating the occupant compartment, or present an undue hazard to other traffic, pedestrians, or personnel in a work zone.</i>	The Option C temporary work zone sign support fractured into several pieces; however, there was no concern for potential deformation or intrusion into the vehicle.	Pass
<i>Deformations of, or intrusions into, the occupant compartment should not exceed limits set forth in Section 5.3 and Appendix E of MASH.</i>	No occupant compartment deformation or intrusion was noted.	Pass
<i>E. Detached elements, fragments, or other debris from the test article, of vehicular damage should not block the driver's vision or otherwise cause the driver to lose control of the vehicle.</i>	The fractured pieces of the Option C temporary work zone sign support did not block the driver's view or otherwise cause the driver to lose control of the 1100C vehicle.	Pass
<i>F. The vehicle should remain upright during and after collision. The maximum roll and pitch angles are not to exceed 75 degrees.</i>	The 1100C vehicle remained upright during and after the collision event.	Pass
<i>H. Longitudinal and lateral occupant impact velocities should fall below the preferred value of 10 ft/s, or at least below the maximum allowable value of 16.4 ft/s.</i>	Assessment of occupant risk factors is not required for test articles having a total weight of 220 lb or less.	NA
<i>I. Longitudinal and lateral occupant ridedown accelerations should fall below the preferred value of 15.0 Gs, or at least below the maximum allowable value of 20.49 Gs.</i>	The weight of the Option C temporary work zone sign support system was 57 lb.	NA
Vehicle Trajectory		
<i>N. Vehicle trajectory behind the test article is acceptable.</i>	The 1100C vehicle came to rest 480 ft behind the Option C temporary work zone sign support.	Pass

Table 8.9. Performance Evaluation Summary for MASH Test 3-72 at 0 Degrees on the Option C Temporary Work Zone Sign Support.

Test Agency: Texas A&M Transportation Institute

Test No.: 490026-2-9

Test Date: 2016-03-14

MASH Test 3-72 Evaluation Criteria	Test Results	Assessment
Structural Adequacy		
<i>B. The test article should readily activate in a predictable manner by breaking away, fracturing, or yielding.</i>	The Option C temporary work zone sign support readily activated by yielding to the 2270P vehicle.	Pass
Occupant Risk		
<i>D. Detached elements, fragments, or other debris from the test article should not penetrate or show potential for penetrating the occupant compartment, or present an undue hazard to other traffic, pedestrians, or personnel in a work zone.</i>	The Option C temporary work zone sign support fractured into several pieces; however, there was no concern for potential deformation or intrusion into the vehicle.	Pass
<i>Deformations of, or intrusions into, the occupant compartment should not exceed limits set forth in Section 5.3 and Appendix E of MASH.</i>	No occupant compartment deformation or intrusion was noted.	Pass
<i>E. Detached elements, fragments, or other debris from the test article, of vehicular damage should not block the driver's vision or otherwise cause the driver to lose control of the vehicle.</i>	The fractured pieces of the Option C temporary work zone sign support did not block the driver's view or otherwise cause the driver to lose control of the 1100C vehicle.	Pass
<i>F. The vehicle should remain upright during and after collision. The maximum roll and pitch angles are not to exceed 75 degrees.</i>	The 2270P vehicle remained upright during and after the collision event.	Pass
<i>H. Longitudinal and lateral occupant impact velocities should fall below the preferred value of 10 ft/s, or at least below the maximum allowable value of 16.4 ft/s.</i>	Assessment of occupant risk factors is not required for test articles having a total weight of 220 lb or less.	NA
<i>I. Longitudinal and lateral occupant ridedown accelerations should fall below the preferred value of 15.0 Gs, or at least below the maximum allowable value of 20.49 Gs.</i>	The weight of the Option C temporary work zone sign support system was 57 lb.	NA
Vehicle Trajectory		
<i>N. Vehicle trajectory behind the test article is acceptable.</i>	The 2270P vehicle came to rest 480 ft behind the Option C temporary work zone sign support.	Pass

Chapter 9. IMPLEMENTATION STATEMENT

The objective of this research was to develop a nonproprietary, lightweight, crashworthy temporary work-zone single sign support with an aluminum sign substrate. The device was intended to meet the evaluation criteria in *MASH*. In addition to crashworthiness, due consideration was given to cost and functionality. The system was designed for a mounting-height of 7 ft. The researchers used perforated steel tubing for the frame of the new temporary single sign support system. Use of perforated steel tubing makes the system relatively lightweight, durable, easy to assemble, and adjustable.

The Option B and Option C temporary work zone sign supports functioned acceptably in all four *MASH* tests performed. Therefore, these options are considered suitable for implementation on Texas roads.

REFERENCES

1. Manual on Uniform Traffic Control Devices (MUTCD): <http://mutcd.fhwa.dot.gov> Last accessed August 01, 2016.
2. AASHTO, *Manual for Assessing Safety Hardware*, American Association of State Highway and Transportation Officials, Washington, D.C., 2009.
3. Silvestri C., D. R. Arrington, R. P. Bligh, and W. L. Menges. “[Development and MASH Full-Scale Crash Testing of a High-Mounting-Height Temporary Single Sign Support with Aluminum Sign](#),” Research Report 9-1002-12-7, Texas A&M Transportation Institute, College Station, TX, August 2012.

APPENDIX A. CRASH TEST NO. 490026-2-1 (MASH TEST 3-72)

A1 VEHICLE PROPERTIES AND INFORMATION

Table A.1. Vehicle Properties for Test No. 490026-2-1 through 490026-2-3.

Date: 2016-03-03 Test No.: 490026-2-1/2/3 VIN No.: 1D7RB1GP5AS126554

Year: 2010 Make: Dodge Model: Ram 1500

Tire Size: 265/70R17 Tire Inflation Pressure: 35 psi

Tread Type: Highway Odometer: 173708

Note any damage to the vehicle prior to test: None noted

- Denotes accelerometer location.

NOTES: None

Engine Type: V-8
 Engine CID: 4.7 liter

Transmission Type:
 Auto or Manual
 FWD RWD 4WD

Optional Equipment:
None

Dummy Data:
 Type: No dummy
 Mass: NA
 Seat Position: NA

Geometry: inches

A	<u>78.50</u>	F	<u>40.00</u>	K	<u>19.50</u>	P	<u>3.00</u>	U	<u>----</u>
B	<u>74.00</u>	G	<u>28.38</u>	L	<u>29.00</u>	Q	<u>30.50</u>	V	<u>----</u>
C	<u>227.50</u>	H	<u>62.43</u>	M	<u>68.50</u>	R	<u>18.00</u>	W	<u>----</u>
D	<u>47.00</u>	I	<u>12.50</u>	N	<u>68.00</u>	S	<u>13.00</u>	X	<u>----</u>
E	<u>140.50</u>	J	<u>27.50</u>	O	<u>46.50</u>	T	<u>77.00</u>		<u>----</u>
Wheel Center Height Front		<u>14.75</u>	Wheel Well Clearance (Front)		<u>6.00</u>	Bottom Frame Height - Front		<u>17.00</u>	
Wheel Center Height Rear		<u>14.75</u>	Wheel Well Clearance (Rear)		<u>9.25</u>	Bottom Frame Height - Rear		<u>25.50</u>	

RANGE LIMIT: A=78 ±2 inches; C=237 ±13 inches; E=148 ±12 inches; F=39 ±3 inches; G = > 28 inches; H = 63 ±4 inches; O=43 ±4 inches; M+N/2=67 ±1.5 inches

GVWR Ratings:	Mass: lb	Curb	Test Inertial	Gross Static
Front <u>3700</u>	M_{front}	<u>2850</u>	<u>2786</u>	<u>----</u>
Back <u>3900</u>	M_{rear}	<u>2048</u>	<u>2228</u>	<u>----</u>
Total <u>6700</u>	M_{Total}	<u>4898</u>	<u>5014</u>	<u>----</u>

(Allowable Range for TIM and GSM = 5000 lb ±110 lb)

Mass Distribution:

lb LF: 1388 RF: 1398 LR: 1084 RR: 1144

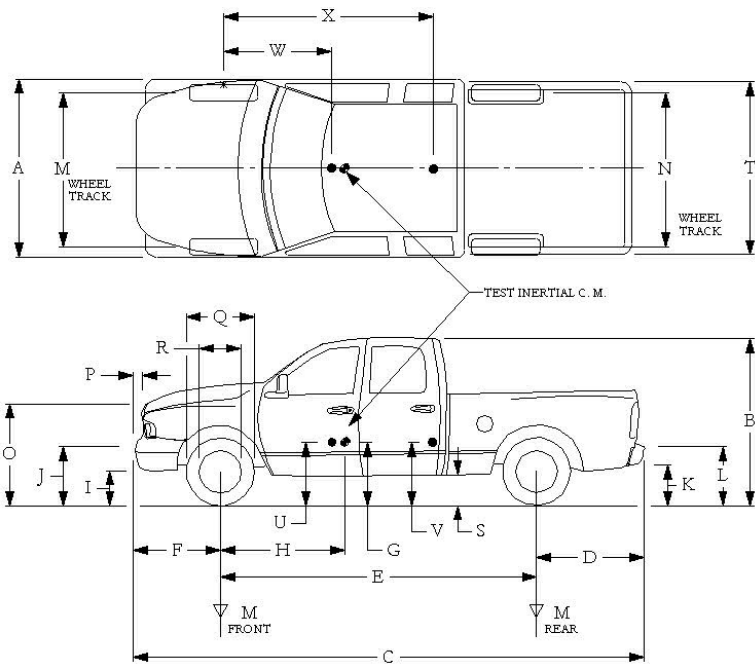

Table A.2. Measurements of Vehicle Vertical CG for Test No. 490026-2-1 through 490026-2-3.

Date: 2016-03-03 Test No.: 490026-2-1/2/3 VIN: 1D7RB1GP5AS126554
 Year: 2010 Make: Dodge Model: Ram 1500
 Body Style: Quad Cab Mileage: 173708
 Engine: 4.7 liter V-8 Transmission: Automatic
 Fuel Level: Empty Ballast: 228 lb (440 lb max)
 Tire Pressure: Front: 35 psi Rear: 35 psi Size: 265/70R17

Measured Vehicle Weights: (lb)			
LF:	<u>1388</u>	RF:	<u>1398</u>
		Front Axle:	<u>2786</u>
LR:	<u>1084</u>	RR:	<u>1144</u>
		Rear Axle:	<u>2228</u>
Left:	<u>2472</u>	Right:	<u>2542</u>
		Total:	<u>5014</u>
			5000 ±110 lb allowed
Wheel Base:	<u>140.5</u> inches	Track: F:	<u>68.5</u> inches
	148 ±12 inches allowed	R:	<u>68</u> inches
			Track = (F+R)/2 = 67 ±1.5 inches allowed
Center of Gravity, SAE J874 Suspension Method			
X:	<u>62.43</u> in	Rear of Front Axle	(63 ±4 inches allowed)
Y:	<u>0.48</u> in	Left - Right +	of Vehicle Centerline
Z:	<u>28.375</u> in	Above Ground	(minimum 28.0 inches allowed)

Hood Height: 46.5 inches Front Bumper Height: 27.5 inches
 43 ±4 inches allowed

Front Overhang: 40.0 inches Rear Bumper Height: 29.0 inches
 39 ±3 inches allowed

Overall Length: 227.5 inches
 237 ±13 inches allowed

Table A.3. Exterior Crush Measurements for Test No. 490026-2-1.

Date: 2016-03-03 Test No.: 490026-2-1 VIN No.: 1D7RB1GP5AS126554
 Year: 2010 Make: Dodge Model: Ram 1500

VEHICLE CRUSH MEASUREMENT SHEET¹

Complete When Applicable	
End Damage	Side Damage
Undeformed end width _____ Corner shift: A1 _____ A2 _____ End shift at frame (CDC) (check one) < 4 inches _____ ≥ 4 inches _____	Bowing: B1 _____ X1 _____ B2 _____ X2 _____ Bowing constant $\frac{X1 + X2}{2} = \underline{\hspace{2cm}}$

Note: Measure C₁ to C₆ from Driver to Passenger Side in Front or Rear impacts – Rear to Front in Side Impacts.

Specific Impact Number	Plane* of C-Measurements	Direct Damage		Field L**	C ₁	C ₂	C ₃	C ₄	C ₅	C ₆	±D
		Width** (CDC)	Max*** Crush								
1	Front plane at bumper ht	---	2.5	---	---	---	---	---	---	---	---
	Measurements recorded										
	in inches										

¹Table taken from National Accident Sampling System (NASS).

*Identify the plane at which the C-measurements are taken (e.g., at bumper, above bumper, at sill, above sill, at beltline, etc.) or label adjustments (e.g., free space).

Free space value is defined as the distance between the baseline and the original body contour taken at the individual C locations. This may include the following: bumper lead, bumper taper, side protrusion, side taper, etc. Record the value for each C-measurement and maximum crush.

**Measure and document on the vehicle diagram the beginning or end of the direct damage width and field L (e.g., side damage with respect to undamaged axle).

***Measure and document on the vehicle diagram the location of the maximum crush.

Note: Use as many lines/columns as necessary to describe each damage profile.

Table A.4. Occupant Compartment Measurements for Test No. 490026-2-1.

Date: 2016-03-03 Test No.: 490026-2-1 VIN No.: 1D7RB1GP5AS126554
 Year: 2010 Make: Dodge Model: Ram 1500

OCCUPANT COMPARTMENT DEFORMATION MEASUREMENT

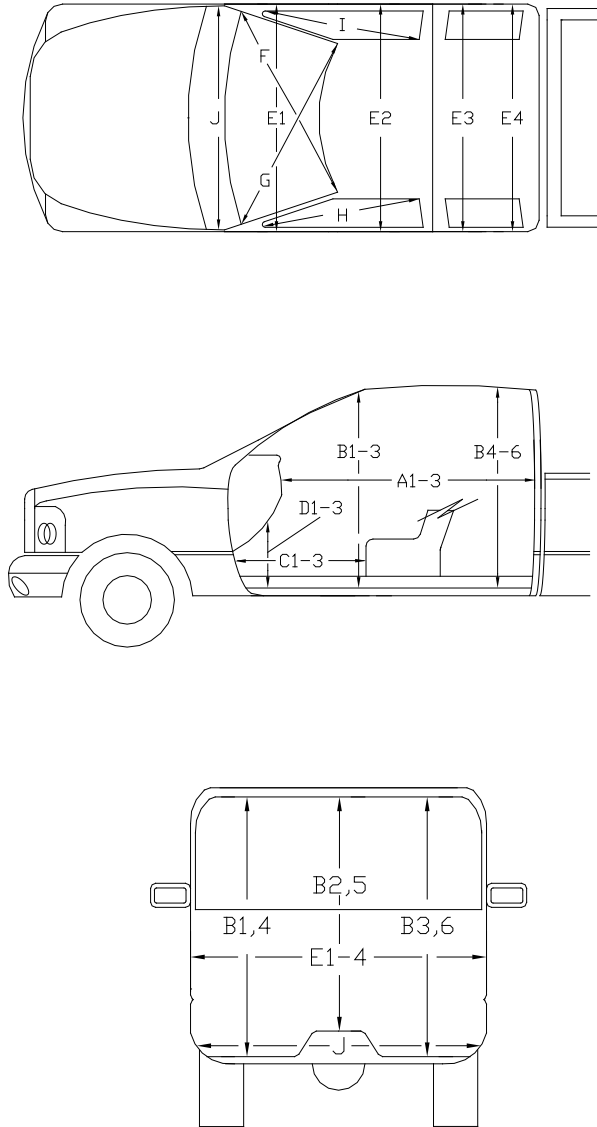

	Before (inches)	After (inches)
A1	65.50	65.50
A2	63.50	63.50
A3	65.50	65.50
B1	45.00	45.00
B2	37.75	37.75
B3	45.00	45.00
B4	39.50	39.50
B5	41.00	41.00
B6	39.50	39.50
C1	26.50	26.50
C2	-----	-----
C3	26.00	26.00
D1	11.25	11.25
D2	-----	-----
D3	11.25	11.25
E1	58.50	58.50
E2	63.50	63.50
E3	63.50	63.50
E4	63.25	63.25
F	59.00	59.00
G	59.00	59.00
H	37.50	37.50
I	37.50	37.50
J*	23.00	23.00

*Lateral area across the cab from driver's side kickpanel to passenger's side kickpanel.

A2 SEQUENTIAL PHOTOGRAPHS

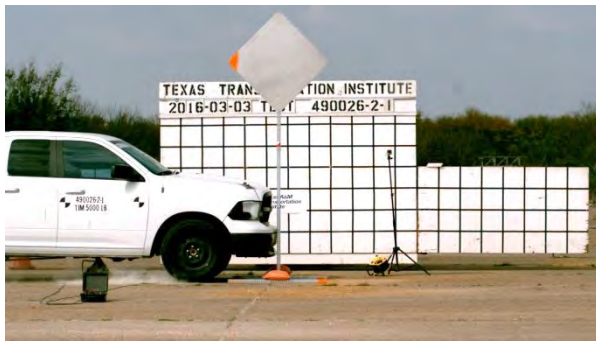

Figure A.1. Sequential Photographs for Test No. 490026-2-1 (Perpendicular and Oblique Views).



0.120 s



0.150 s



0.180 s



0.210 s



Figure A.1. Sequential Photographs for Test No. 490026-2-1 (Perpendicular and Oblique Views) (Continued).

APPENDIX B. CRASH TEST NO. 490026-2-2 (MASH TEST 3-72)

B1 VEHICLE PROPERTIES AND INFORMATION

Table B.1. Vehicle Properties for Test No. 490026-2-2.

Date: 2016-03-03 Test No.: 490026-2-1/2/3 VIN No.: 1D7RB1GP5AS126554
 Year: 2010 Make: Dodge Model: Ram 1500
 Tire Size: 265/70R17 Tire Inflation Pressure: 35 psi
 Tread Type: Highway Odometer: 173708
 Note any damage to the vehicle prior to test: None noted

• Denotes accelerometer location.

NOTES: None

Engine Type: V-8
 Engine CID: 4.7 liter

Transmission Type:
 Auto or Manual
 FWD RWD 4WD

Optional Equipment:
None

Dummy Data:
 Type: No dummy
 Mass: NA
 Seat Position: NA

Geometry: inches

A	<u>78.50</u>	F	<u>40.00</u>	K	<u>19.50</u>	P	<u>3.00</u>	U	<u>----</u>
B	<u>74.00</u>	G	<u>28.38</u>	L	<u>29.00</u>	Q	<u>30.50</u>	V	<u>----</u>
C	<u>227.50</u>	H	<u>62.43</u>	M	<u>68.50</u>	R	<u>18.00</u>	W	<u>----</u>
D	<u>47.00</u>	I	<u>12.50</u>	N	<u>68.00</u>	S	<u>13.00</u>	X	<u>----</u>
E	<u>140.50</u>	J	<u>27.50</u>	O	<u>46.50</u>	T	<u>77.00</u>		<u>----</u>
Wheel Center Height Front	<u>14.75</u>	Wheel Well Clearance (Front)	<u>6.00</u>	Bottom Frame Height - Front	<u>17.00</u>				
Wheel Center Height Rear	<u>14.75</u>	Wheel Well Clearance (Rear)	<u>9.25</u>	Bottom Frame Height - Rear	<u>25.50</u>				

RANGE LIMIT: A=78 ±2 inches; C=237 ±13 inches; E=148 ±12 inches; F=39 ±3 inches; G = > 28 inches; H = 63 ±4 inches; O=43 ±4 inches; M+N/2=67 ±1.5 inches

GVWR Ratings:	Mass: lb	Curb	Test Inertial	Gross Static
Front <u>3700</u>	M_{front}	<u>2850</u>	<u>2786</u>	<u>----</u>
Back <u>3900</u>	M_{rear}	<u>2048</u>	<u>2228</u>	<u>----</u>
Total <u>6700</u>	M_{Total}	<u>4898</u>	<u>5014</u>	<u>----</u>

(Allowable Range for TIM and GSM = 5000 lb ±110 lb)

Mass Distribution:

lb LF: 1388 RF: 1398 LR: 1084 RR: 1144

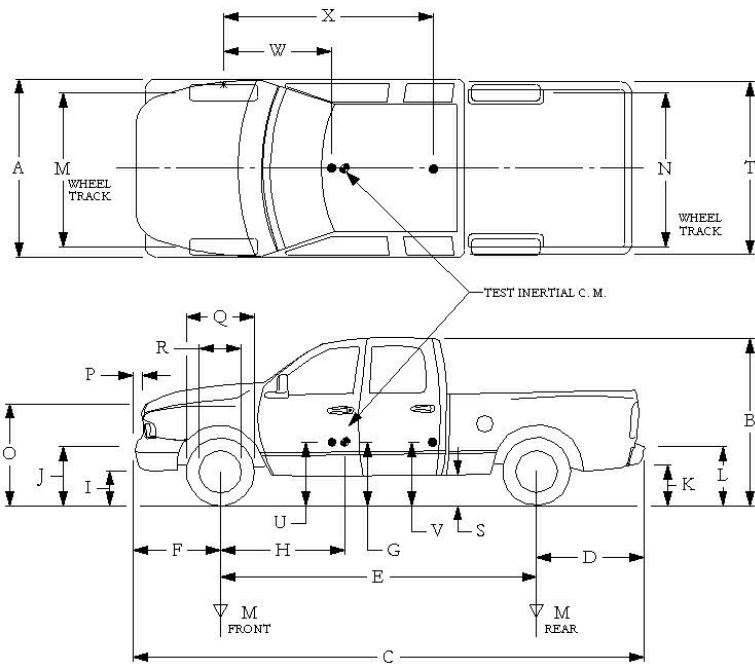

Table B.2. Measurements of Vehicle Vertical CG for Test No. 490026-2-2.

Date: 2016-03-03 Test No.: 490026-2-1/2/3 VIN: 1D7RB1GP5AS126554
 Year: 2010 Make: Dodge Model: Ram 1500
 Body Style: Quad Cab Mileage: 173708
 Engine: 4.7 liter V-8 Transmission: Automatic
 Fuel Level: Empty Ballast: 228 lb (440 lb max)
 Tire Pressure: Front: 35 psi Rear: 35 psi Size: 265/70R17

Measured Vehicle Weights: (lb)			
LF:	<u>1388</u>	RF:	<u>1398</u>
		Front Axle:	<u>2786</u>
LR:	<u>1084</u>	RR:	<u>1144</u>
		Rear Axle:	<u>2228</u>
Left:	<u>2472</u>	Right:	<u>2542</u>
		Total:	<u>5014</u>
			5000 ±110 lb allow ed
Wheel Base:	<u>140.5</u> inches	Track: F:	<u>68.5</u> inches
	148 ±12 inches allow ed	R:	<u>68</u> inches
			Track = (F+R)/2 = 67 ±1.5 inches allow ed
Center of Gravity, SAE J874 Suspension Method			
X:	<u>62.43</u> in	Rear of Front Axle	(63 ±4 inches allow ed)
Y:	<u>0.48</u> in	Left - Right +	of Vehicle Centerline
Z:	<u>28.375</u> in	Above Ground	(minumum 28.0 inches allow ed)

Hood Height: 46.5 inches Front Bumper Height: 27.5 inches
 43 ±4 inches allowed

Front Overhang: 40.0 inches Rear Bumper Height: 29.0 inches
 39 ±3 inches allowed

Overall Length: 227.5 inches
 237 ±13 inches allowed

Table B.3. Exterior Crush Measurements for Test No. 490026-2-2.

Date: 2016-03-03 Test No.: 490026-2-2 VIN No.: 1D7RB1GP5AS126554
 Year: 2010 Make: Dodge Model: Ram 1500

VEHICLE CRUSH MEASUREMENT SHEET¹

Complete When Applicable	
End Damage	Side Damage
Undeformed end width _____ Corner shift: A1 _____ A2 _____ End shift at frame (CDC) (check one) < 4 inches _____ ≥ 4 inches _____	Bowing: B1 _____ X1 _____ B2 _____ X2 _____ Bowing constant $\frac{X1 + X2}{2} = \underline{\hspace{2cm}}$

Note: Measure C₁ to C₆ from Driver to Passenger Side in Front or Rear impacts – Rear to Front in Side Impacts.

Specific Impact Number	Plane* of C-Measurements	Direct Damage		Field L**	C ₁	C ₂	C ₃	C ₄	C ₅	C ₆	±D
		Width** (CDC)	Max*** Crush								
1	Front plane at bumper ht	---	2.5	---	---	---	---	---	---	---	---
	Measurements recorded										
	in inches										

¹Table taken from National Accident Sampling System (NASS).

*Identify the plane at which the C-measurements are taken (e.g., at bumper, above bumper, at sill, above sill, at beltline, etc.) or label adjustments (e.g., free space).

Free space value is defined as the distance between the baseline and the original body contour taken at the individual C locations. This may include the following: bumper lead, bumper taper, side protrusion, side taper, etc. Record the value for each C-measurement and maximum crush.

**Measure and document on the vehicle diagram the beginning or end of the direct damage width and field L (e.g., side damage with respect to undamaged axle).

***Measure and document on the vehicle diagram the location of the maximum crush.

Note: Use as many lines/columns as necessary to describe each damage profile.

Table B.4. Occupant Compartment Measurements for Test No. 490026-2-2.

Date: 2016-03-03 Test No.: 490026-2-2 VIN No.: 1D7RB1GP5AS126554
 Year: 2010 Make: Dodge Model: Ram 1500

OCCUPANT COMPARTMENT DEFORMATION MEASUREMENT

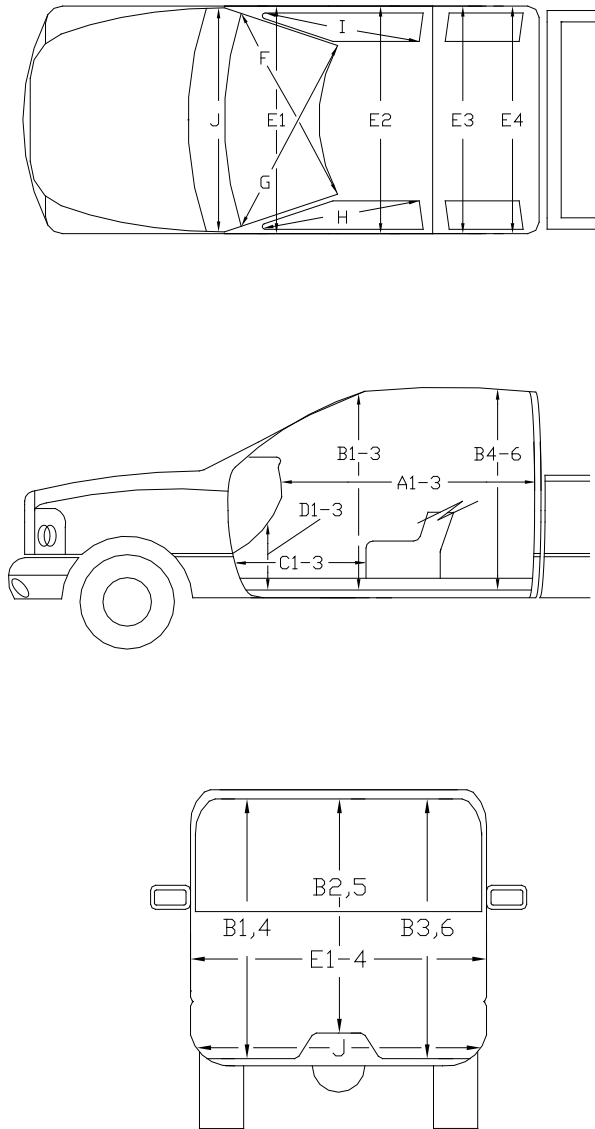

	Before (inches)	After (inches)
A1	65.50	65.50
A2	63.50	63.50
A3	65.50	65.50
B1	45.00	45.00
B2	37.75	37.75
B3	45.00	45.00
B4	39.50	39.50
B5	41.00	41.00
B6	39.50	39.50
C1	26.50	26.50
C2	-----	-----
C3	26.00	26.00
D1	11.25	11.25
D2	-----	-----
D3	11.25	11.25
E1	58.50	58.50
E2	63.50	63.50
E3	63.50	63.50
E4	63.25	63.25
F	59.00	59.00
G	59.00	59.00
H	37.50	37.50
I	37.50	37.50
J*	23.00	23.00

*Lateral area across the cab from driver's side kickpanel to passenger's side kickpanel.

B2 SEQUENTIAL PHOTOGRAPHS



0.000 s



0.030 s

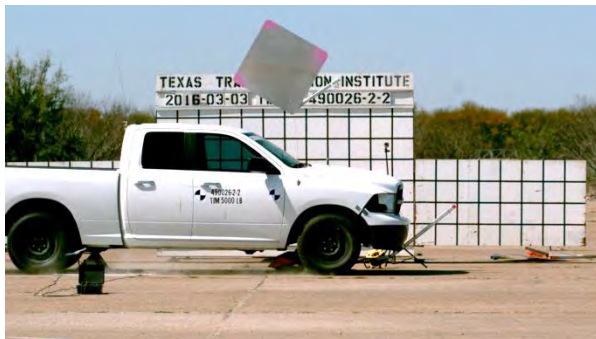

0.060 s

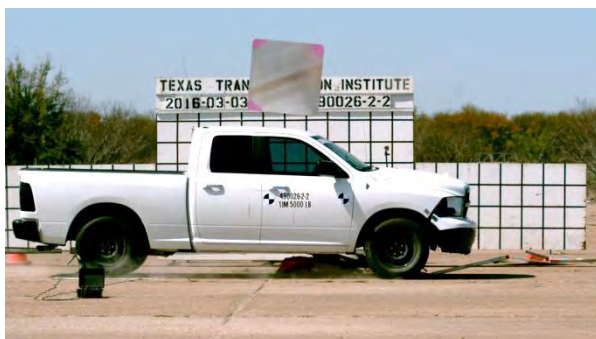

0.090 s



Figure B.1. Sequential Photographs for Test No. 490026-2-2 (Perpendicular and Oblique Views).



0.120 s



0.150 s



0.180 s



0.210 s



Figure B.1. Sequential Photographs for Test No. 490026-2-2 (Perpendicular and Oblique Views) (Continued).

APPENDIX C. CRASH TEST NO. 490026-2-4 (MASH TEST 3-71)

C1 VEHICLE PROPERTIES AND INFORMATION

Table C.1. Vehicle Properties for Test Nos. 490026-2-4.

Date: 2016-03-11 Test No.: 490026-2-4/5/6/7 VIN No.: KNAD14A35B6916812
 Year: 2011 Make: Kia Model: Rio
 Tire Inflation Pressure: 32 psi Odometer: 95120 Tire Size: P185/65R14
 Describe any damage to the vehicle prior to test: None

• Denotes accelerometer location.

NOTES: None

Engine Type: 4 cylinder
 Engine CID: 1.6 liter
 Transmission Type:
x Auto or _____ Manual
x FWD _____ RWD _____ 4WD
 Optional Equipment:
None

Dummy Data:
 Type: 50th percentile male
 Mass: 165 lb
 Seat Position: Driver

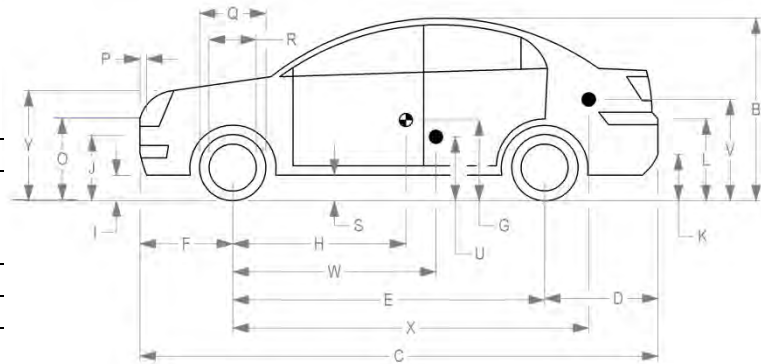
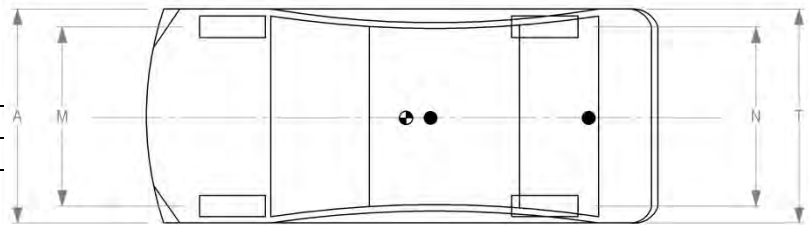

Geometry: inches

A	<u>66.38</u>	F	<u>33.00</u>	K	<u>12.20</u>	P	<u>4.12</u>	U	<u>NA</u>	
B	<u>58.00</u>	G	<u>-----</u>	L	<u>25.00</u>	Q	<u>22.50</u>	V	<u>NA</u>	
C	<u>165.75</u>	H	<u>35.93</u>	M	<u>57.75</u>	R	<u>15.50</u>	W	<u>NA</u>	
D	<u>34.00</u>	I	<u>8.00</u>	N	<u>57.10</u>	S	<u>7.25</u>	X	<u>NA</u>	
E	<u>98.75</u>	J	<u>21.50</u>	O	<u>28.25</u>	T	<u>66.20</u>	Y	<u>27.00</u>	
	Wheel Center Ht Front		<u>11.00</u>		Wheel Center Ht Rear		<u>11.00</u>		W-H	<u>NA</u>

GVWR Ratings:

	Mass: lb	Curb	Test Inertial	Gross Static
Front	<u>1918</u>	<u>M_{front}</u>	<u>1579</u>	<u>1640</u>
Back	<u>1874</u>	<u>M_{rear}</u>	<u>900</u>	<u>968</u>
Total	<u>3638</u>	<u>M_{Total}</u>	<u>2479</u>	<u>2608</u>

Allowable TIM = 2420 lb ±55 lb | Allowable GSM = 2585 lb ± 55 lb

Mass Distribution:

lb LF: 800 RF: 754 LR: 440 RR: 449

Table C.2. Exterior Crush Measurements for Test No. 490026-2-4.

Date: 2016-03-11 Test No.: 490026-2-4 VIN No.: KNAD14A35B6916812

Year: 2011 Make: Kia Model: Rio

VEHICLE CRUSH MEASUREMENT SHEET¹

Complete When Applicable	
End Damage	Side Damage
Undeformed end width _____ Corner shift: A1 _____ A2 _____ End shift at frame (CDC) (check one) < 4 inches _____ ≥ 4 inches _____	Bowing: B1 _____ X1 _____ B2 _____ X2 _____ Bowing constant $\frac{X1 + X2}{2} = \underline{\hspace{2cm}}$

Note: Measure C₁ to C₆ from Driver to Passenger Side in Front or Rear impacts – Rear to Front in Side Impacts.

Specific Impact Number	Plane* of C-Measurements	Direct Damage		Field L**	C ₁	C ₂	C ₃	C ₄	C ₅	C ₆	±D
		Width** (CDC)	Max*** Crush								
1	Front plane at bumper ht	0	0	---	---	---	---	---	---	---	---
	Measurements recorded										
	in inches										

¹Table taken from National Accident Sampling System (NASS).

*Identify the plane at which the C-measurements are taken (e.g., at bumper, above bumper, at sill, above sill, at beltline, etc.) or label adjustments (e.g., free space).

Free space value is defined as the distance between the baseline and the original body contour taken at the individual C locations. This may include the following: bumper lead, bumper taper, side protrusion, side taper, etc. Record the value for each C-measurement and maximum crush.

**Measure and document on the vehicle diagram the beginning or end of the direct damage width and field L (e.g., side damage with respect to undamaged axle).

***Measure and document on the vehicle diagram the location of the maximum crush.

Note: Use as many lines/columns as necessary to describe each damage profile.

Table C.3. Occupant Compartment Measurements for Test No. 490026-2-4.

Date: 2016-03-11 Test No.: 490026-2-4 VIN No.: KNAD14A35B6916812

Year: 2011 Make: Kia Model: Rio

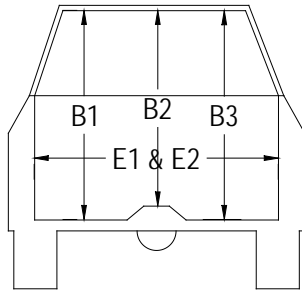
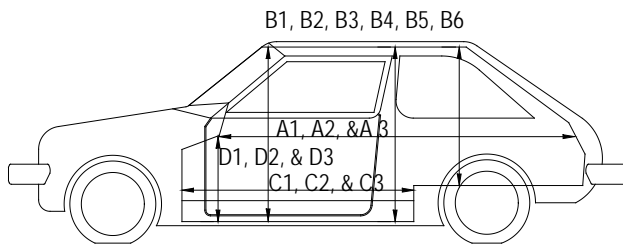
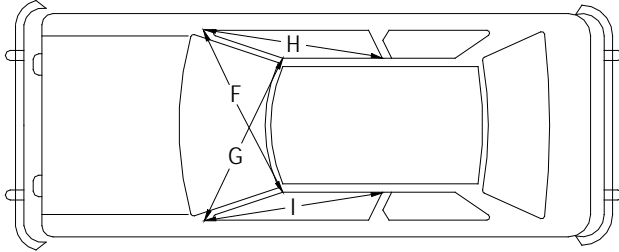

OCCUPANT COMPARTMENT DEFORMATION MEASUREMENT

	Before (inches)	After (inches)
A1	67.50	67.50
A2	67.25	67.25
A3	67.75	67.75
B1	40.50	40.50
B2	35.75	35.75
B3	40.50	40.50
B4	36.00	36.00
B5	32.50	32.50
B6	36.00	36.00
C1	27.25	27.25
C2	-----	-----
C3	27.00	27.00
D1	9.50	9.50
D2	-----	-----
D3	9.25	9.25
E1	51.50	51.50
E2	51.00	51.00
F	51.00	51.00
G	51.00	51.00
H	37.50	37.50
I	37.50	37.50
J*	51.00	51.00

*Lateral area across the cab from driver's side kickpanel to passenger's side kickpanel.

C2 SEQUENTIAL PHOTOGRAPHS



Figure C.1. Sequential Photographs for Test No. 490026-2-4 (Perpendicular and Oblique Views).



0.120 s



0.160 s



0.180 s



0.210 s



Figure C.1. Sequential Photographs for Test No. 49026-2-4 (Perpendicular and Oblique Views) (Continued).

APPENDIX D. CRASH TEST NO. 490026-2-6 (MASH TEST 3-71)

D1 VEHICLE PROPERTIES AND INFORMATION

Table D.1. Vehicle Properties for Test No. 490026-2-6.

Date: 2016-03-11 Test No.: 490026-2-6 VIN No.: KNAD14A35B6916812
 Year: 2011 Make: Kia Model: Rio
 Tire Inflation Pressure: 32 psi Odometer: 95120 Tire Size: P185/65R14
 Describe any damage to the vehicle prior to test: None

• Denotes accelerometer location.

NOTES: None

Engine Type: 4 cylinder
 Engine CID: 1.6 liter
 Transmission Type:
x Auto or _____ Manual
x FWD _____ RWD _____ 4WD
 Optional Equipment:
None

Dummy Data:
 Type: 50th percentile male
 Mass: 165 lb
 Seat Position: Driver

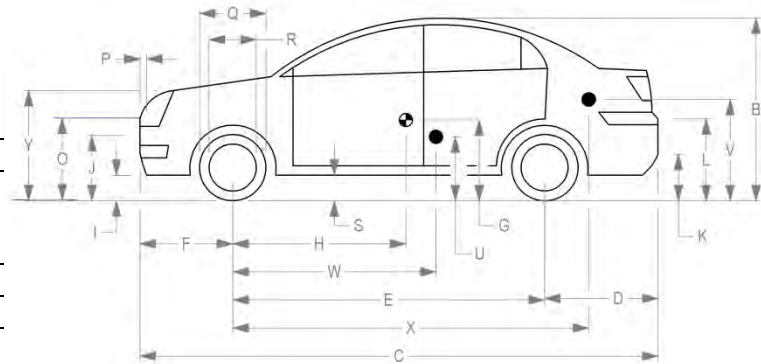
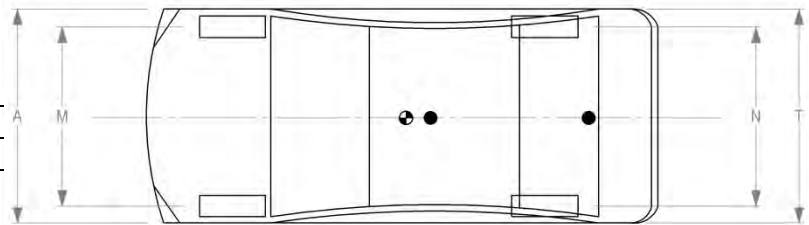

Geometry: inches

A	<u>66.38</u>	F	<u>33.00</u>	K	<u>12.20</u>	P	<u>4.12</u>	U	<u>NA</u>	
B	<u>58.00</u>	G	<u>-----</u>	L	<u>25.00</u>	Q	<u>22.50</u>	V	<u>NA</u>	
C	<u>165.75</u>	H	<u>35.93</u>	M	<u>57.75</u>	R	<u>15.50</u>	W	<u>NA</u>	
D	<u>34.00</u>	I	<u>8.00</u>	N	<u>57.10</u>	S	<u>7.25</u>	X	<u>NA</u>	
E	<u>98.75</u>	J	<u>21.50</u>	O	<u>28.25</u>	T	<u>66.20</u>	Y	<u>27.00</u>	
	Wheel Center Ht Front		<u>11.00</u>		Wheel Center Ht Rear		<u>11.00</u>		W-H	<u>NA</u>

GVWR Ratings:

	Mass: lb	Curb	Test Inertial	Gross Static
Front	<u>1918</u>	<u>M_{front}</u>	<u>1579</u>	<u>1640</u>
Back	<u>1874</u>	<u>M_{rear}</u>	<u>900</u>	<u>968</u>
Total	<u>3638</u>	<u>M_{Total}</u>	<u>2479</u>	<u>2608</u>

Allowable TIM = 2420 lb ±55 lb | Allowable GSM = 2585 lb ± 55 lb

Mass Distribution:

lb LF: 800 RF: 754 LR: 440 RR: 449

Table D.3. Occupant Compartment Measurements for Test No. 490026-2-6.

Date: 2016-03-11 Test No.: 490026-2-6 VIN No.: KNAD14A35B6916812

Year: 2011 Make: Kia Model: Rio

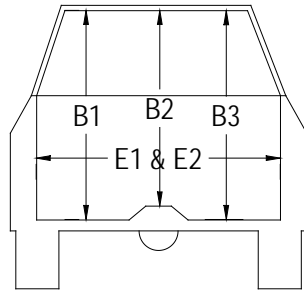
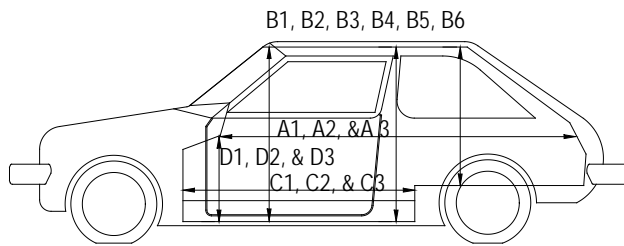
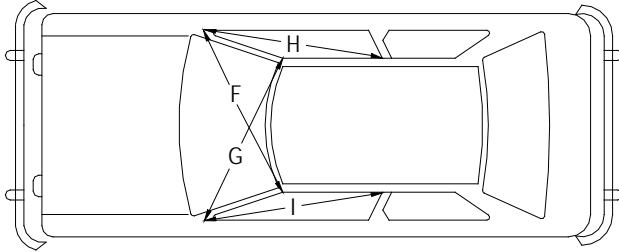

OCCUPANT COMPARTMENT DEFORMATION MEASUREMENT

	Before (inches)	After (inches)
A1	67.50	67.50
A2	67.25	67.25
A3	67.75	67.75
B1	40.50	40.50
B2	35.75	35.75
B3	40.50	40.50
B4	36.00	36.00
B5	32.50	32.50
B6	36.00	36.00
C1	27.25	27.25
C2	-----	-----
C3	27.00	27.00
D1	9.50	9.50
D2	-----	-----
D3	9.25	9.25
E1	51.50	51.50
E2	51.00	51.00
F	51.00	51.00
G	51.00	51.00
H	37.50	37.50
I	37.50	37.50
J*	51.00	51.00

*Lateral area across the cab from driver's side kickpanel to passenger's side kickpanel.

D2 SEQUENTIAL PHOTOGRAPHS

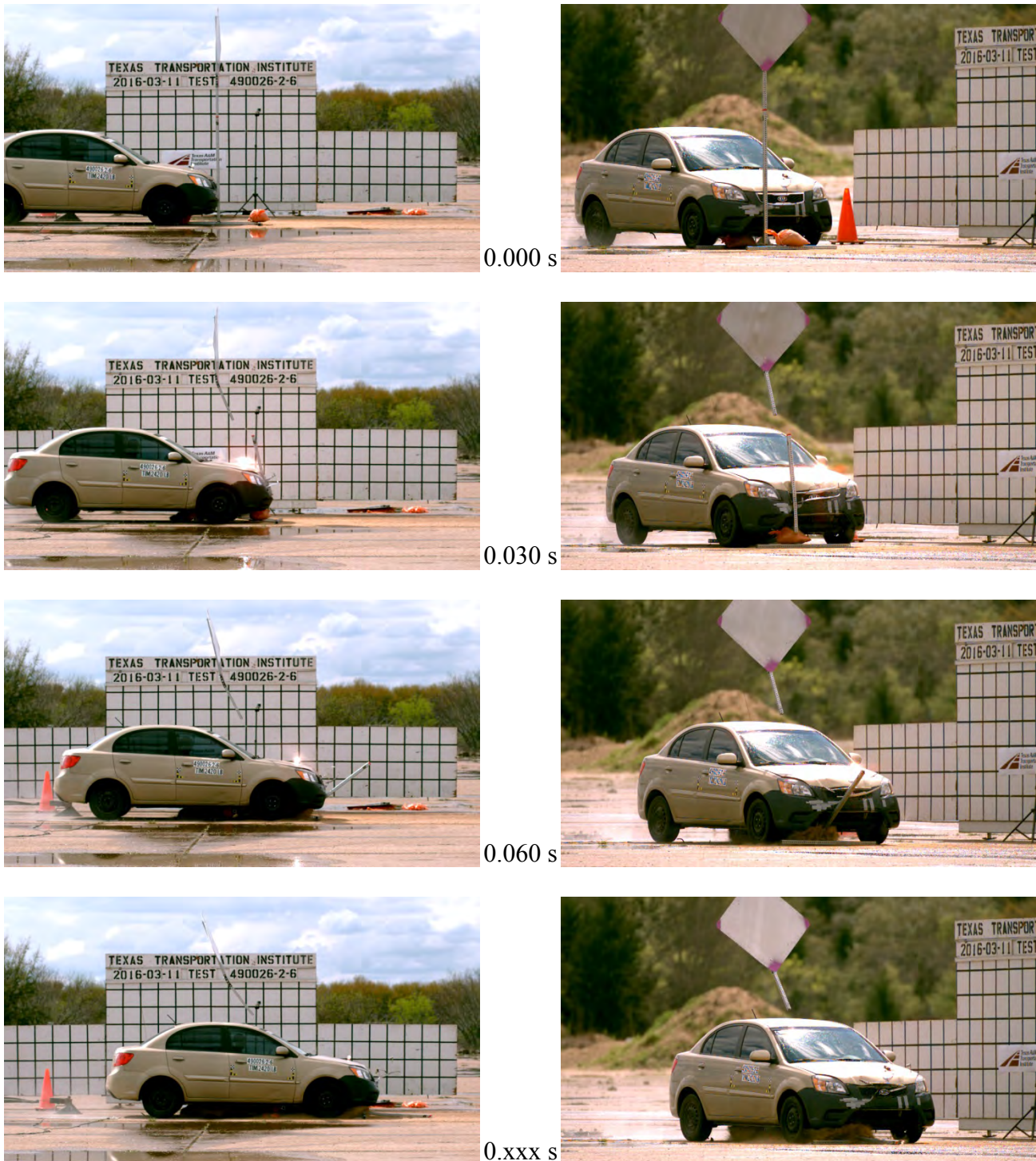

Figure D.1. Sequential Photographs for Test No. 490026-2-6 (Perpendicular and Oblique Views).



0.120 s



0.150 s



0.180 s



0.210 s



Figure D.1. Sequential Photographs for Test No. 490026-2-6 (Perpendicular and Oblique Views) (Continued).

APPENDIX E. CRASH TEST NO. 490026-2-8 (MASH TEST 3-72)

E1 VEHICLE PROPERTIES AND INFORMATION

Table E.1. Vehicle Properties for Test No. 490026-2-8.

Date: 2016-03-03 Test No.: 490026-2-8 and 9 VIN No.: 1D7RB1GP5AS126554
 Year: 2010 Make: Dodge Model: Ram 1500
 Tire Size: 265/70R17 Tire Inflation Pressure: 35 psi
 Tread Type: Highway Odometer: 173708
 Note any damage to the vehicle prior to test: None noted

• Denotes accelerometer location.

NOTES: None

Engine Type: V-8
 Engine CID: 4.7 liter

Transmission Type:
 Auto or Manual
 FWD RWD 4WD

Optional Equipment:
None

Dummy Data:
 Type: No dummy
 Mass: NA
 Seat Position: NA

Geometry: inches

A	<u>78.50</u>	F	<u>40.00</u>	K	<u>19.50</u>	P	<u>3.00</u>	U	<u>----</u>
B	<u>74.00</u>	G	<u>28.38</u>	L	<u>29.00</u>	Q	<u>30.50</u>	V	<u>----</u>
C	<u>227.50</u>	H	<u>62.43</u>	M	<u>68.50</u>	R	<u>18.00</u>	W	<u>----</u>
D	<u>47.00</u>	I	<u>12.50</u>	N	<u>68.00</u>	S	<u>13.00</u>	X	<u>----</u>
E	<u>140.50</u>	J	<u>27.50</u>	O	<u>46.50</u>	T	<u>77.00</u>		<u>----</u>
Wheel Center Height Front	<u>14.75</u>	Wheel Well Clearance (Front)	<u>6.00</u>	Bottom Frame Height - Front	<u>17.00</u>				
Wheel Center Height Rear	<u>14.75</u>	Wheel Well Clearance (Rear)	<u>9.25</u>	Bottom Frame Height - Rear	<u>25.50</u>				

RANGE LIMIT: A=78 ±2 inches; C=237 ±13 inches; E=148 ±12 inches; F=39 ±3 inches; G = > 28 inches; H = 63 ±4 inches; O=43 ±4 inches; M+N/2=67 ±1.5 inches

GVWR Ratings:	Mass: lb	Curb	Test Inertial	Gross Static
Front <u>3700</u>	M_{front} <u>2850</u>	<u>2850</u>	<u>2786</u>	<u>----</u>
Back <u>3900</u>	M_{rear} <u>2048</u>	<u>2048</u>	<u>2228</u>	<u>----</u>
Total <u>6700</u>	M_{Total} <u>4898</u>	<u>4898</u>	<u>5014</u>	<u>----</u>

(Allowable Range for TIM and GSM = 5000 lb ±110 lb)

Mass Distribution:

lb LF: 1388 RF: 1398 LR: 1084 RR: 1144

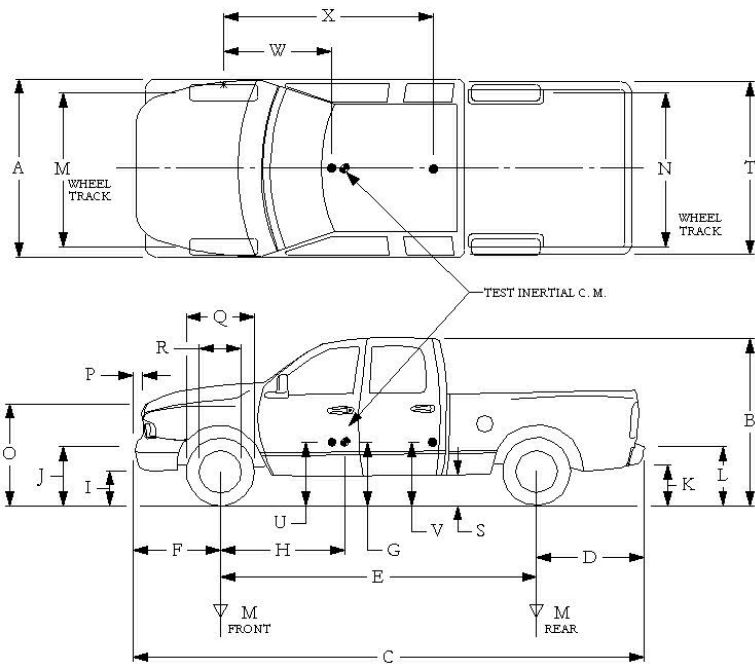

Table E.2. Measurements of Vehicle Vertical CG for Test No. 490026-2-8.

Date: 2016-03-03 Test No.: 490026-2-8 & 9 VIN: 1D7RB1GP5AS126554
 Year: 2010 Make: Dodge Model: Ram 1500
 Body Style: Quad Cab Mileage: 173708
 Engine: 4.7 liter V-8 Transmission: Automatic
 Fuel Level: Empty Ballast: 228 lb (440 lb max)
 Tire Pressure: Front: 35 psi Rear: 35 psi Size: 265/70R17

Measured Vehicle Weights: (lb)			
LF:	<u>1388</u>	RF:	<u>1398</u>
		Front Axle:	<u>2786</u>
LR:	<u>1084</u>	RR:	<u>1144</u>
		Rear Axle:	<u>2228</u>
Left:	<u>2472</u>	Right:	<u>2542</u>
		Total:	<u>5014</u>
			5000 ±110 lb allow ed
Wheel Base:	<u>140.5</u> inches	Track: F:	<u>68.5</u> inches
	148 ±12 inches allow ed	R:	<u>68</u> inches
			Track = (F+R)/2 = 67 ±1.5 inches allow ed
Center of Gravity, SAE J874 Suspension Method			
X:	<u>62.43</u> in	Rear of Front Axle	(63 ±4 inches allow ed)
Y:	<u>0.48</u> in	Left - Right +	of Vehicle Centerline
Z:	<u>28.375</u> in	Above Ground	(minumum 28.0 inches allow ed)

Hood Height: 46.5 inches Front Bumper Height: 27.5 inches
 43 ±4 inches allowed

Front Overhang: 40.0 inches Rear Bumper Height: 29.0 inches
 39 ±3 inches allowed

Overall Length: 227.5 inches
 237 ±13 inches allowed

Table E.3. Exterior Crush Measurements for Test No. 490026-2-8.

Date: 2016-03-03 Test No.: 490026-2-8 VIN No.: 1D7RB1GP5AS126554

Year: 2010 Make: Dodge Model: Ram 1500

VEHICLE CRUSH MEASUREMENT SHEET¹

Complete When Applicable	
End Damage	Side Damage
Undeformed end width _____ Corner shift: A1 _____ A2 _____ End shift at frame (CDC) (check one) < 4 inches _____ ≥ 4 inches _____	Bowing: B1 _____ X1 _____ B2 _____ X2 _____ Bowing constant $\frac{X1 + X2}{2} = \underline{\hspace{2cm}}$

Note: Measure C₁ to C₆ from Driver to Passenger Side in Front or Rear impacts – Rear to Front in Side Impacts.

Specific Impact Number	Plane* of C-Measurements	Direct Damage		Field L**	C ₁	C ₂	C ₃	C ₄	C ₅	C ₆	±D
		Width** (CDC)	Max*** Crush								
1	Front plane at bumper ht	---	4.0	---	---	---	---	---	---	---	---
	Measurements recorded										
	in inches										

¹Table taken from National Accident Sampling System (NASS).

*Identify the plane at which the C-measurements are taken (e.g., at bumper, above bumper, at sill, above sill, at beltline, etc.) or label adjustments (e.g., free space).

Free space value is defined as the distance between the baseline and the original body contour taken at the individual C locations. This may include the following: bumper lead, bumper taper, side protrusion, side taper, etc. Record the value for each C-measurement and maximum crush.

**Measure and document on the vehicle diagram the beginning or end of the direct damage width and field L (e.g., side damage with respect to undamaged axle).

***Measure and document on the vehicle diagram the location of the maximum crush.

Note: Use as many lines/columns as necessary to describe each damage profile.

Table E.4. Occupant Compartment Measurements for Test No. 490026-2-8.

Date: 2016-03-03 Test No.: 490026-2-8 VIN No.: 1D7RB1GP5AS126554
 Year: 2010 Make: Dodge Model: Ram 1500

OCCUPANT COMPARTMENT DEFORMATION MEASUREMENT

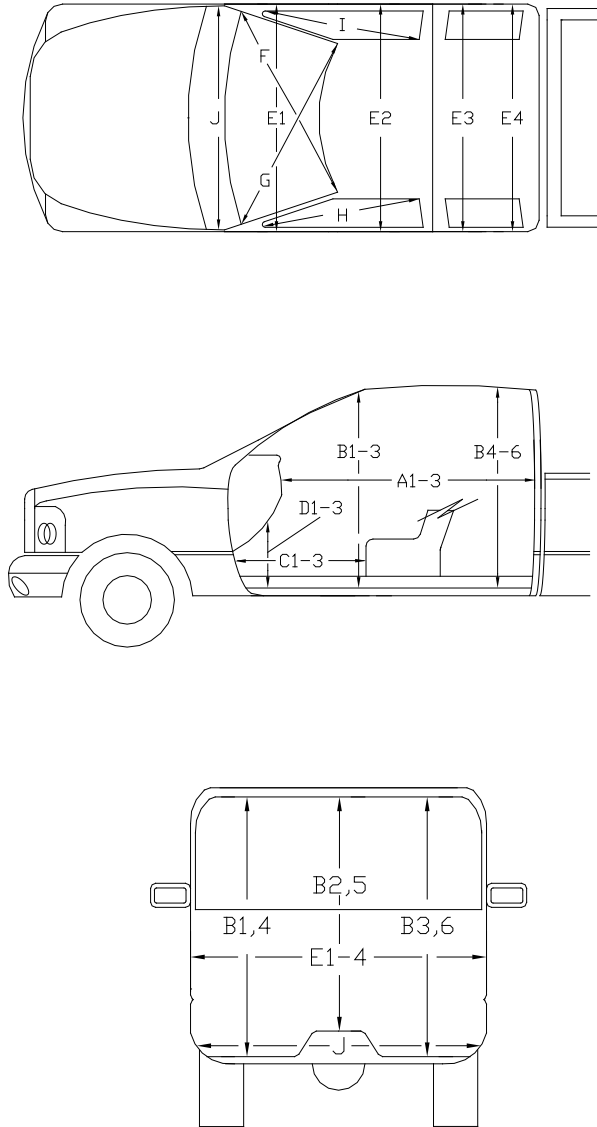

	Before (inches)	After (inches)
A1	65.50	65.50
A2	63.50	63.50
A3	65.50	65.50
B1	45.00	45.00
B2	37.75	37.75
B3	45.00	45.00
B4	39.50	39.50
B5	41.00	41.00
B6	39.50	39.50
C1	26.50	26.50
C2	-----	-----
C3	26.00	26.00
D1	11.25	11.25
D2	-----	-----
D3	11.25	11.25
E1	58.50	58.50
E2	63.50	63.50
E3	63.50	63.50
E4	63.25	63.25
F	59.00	59.00
G	59.00	59.00
H	37.50	37.50
I	37.50	37.50
J*	23.00	23.00

*Lateral area across the cab from driver's side kickpanel to passenger's side kickpanel.

E2 SEQUENTIAL PHOTOGRAPHS



Figure E.1. Sequential Photographs for Test No. 490026-2-8 (Perpendicular and Oblique Views).



0.120 s



0.150 s

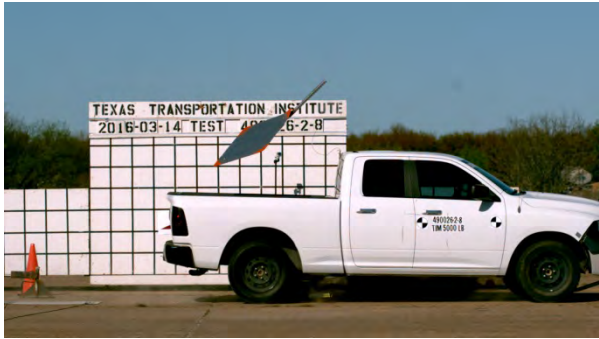

0.180 s



0.210 s



Figure E.1. Sequential Photographs for Test No. 490026-2-8 (Perpendicular and Oblique Views) (Continued).

APPENDIX F. CRASH TEST NO. 490026-2-3 (MASH TEST 3-72)

F1 VEHICLE PROPERTIES AND INFORMATION

Table F.1. Vehicle Properties for Test No. 490026-2-3.

Date: 2016-03-03 Test No.: 490026-2-1/2/3 VIN No.: 1D7RB1GP5AS126554
 Year: 2010 Make: Dodge Model: Ram 1500
 Tire Size: 265/70R17 Tire Inflation Pressure: 35 psi
 Tread Type: Highway Odometer: 173708
 Note any damage to the vehicle prior to test: None noted

• Denotes accelerometer location.

NOTES: None

Engine Type: V-8
 Engine CID: 4.7 liter

Transmission Type:
 Auto or Manual
 FWD RWD 4WD

Optional Equipment:
None

Dummy Data:
 Type: No dummy
 Mass: NA
 Seat Position: NA

Geometry: inches

A	<u>78.50</u>	F	<u>40.00</u>	K	<u>19.50</u>	P	<u>3.00</u>	U	<u>----</u>
B	<u>74.00</u>	G	<u>28.38</u>	L	<u>29.00</u>	Q	<u>30.50</u>	V	<u>----</u>
C	<u>227.50</u>	H	<u>62.43</u>	M	<u>68.50</u>	R	<u>18.00</u>	W	<u>----</u>
D	<u>47.00</u>	I	<u>12.50</u>	N	<u>68.00</u>	S	<u>13.00</u>	X	<u>----</u>
E	<u>140.50</u>	J	<u>27.50</u>	O	<u>46.50</u>	T	<u>77.00</u>		<u>----</u>
Wheel Center Height Front	<u>14.75</u>	Wheel Well Clearance (Front)	<u>6.00</u>	Bottom Frame Height - Front	<u>17.00</u>				
Wheel Center Height Rear	<u>14.75</u>	Wheel Well Clearance (Rear)	<u>9.25</u>	Bottom Frame Height - Rear	<u>25.50</u>				

RANGE LIMIT: A=78 ±2 inches; C=237 ±13 inches; E=148 ±12 inches; F=39 ±3 inches; G = > 28 inches; H = 63 ±4 inches; O=43 ±4 inches; M+N/2=67 ±1.5 inches

GVWR Ratings:	Mass: lb	Curb	Test Inertial	Gross Static
Front <u>3700</u>	M_{front}	<u>2850</u>	<u>2786</u>	<u>----</u>
Back <u>3900</u>	M_{rear}	<u>2048</u>	<u>2228</u>	<u>----</u>
Total <u>6700</u>	M_{Total}	<u>4898</u>	<u>5014</u>	<u>----</u>

(Allowable Range for TIM and GSM = 5000 lb ±110 lb)

Mass Distribution:

lb LF: 1388 RF: 1398 LR: 1084 RR: 1144

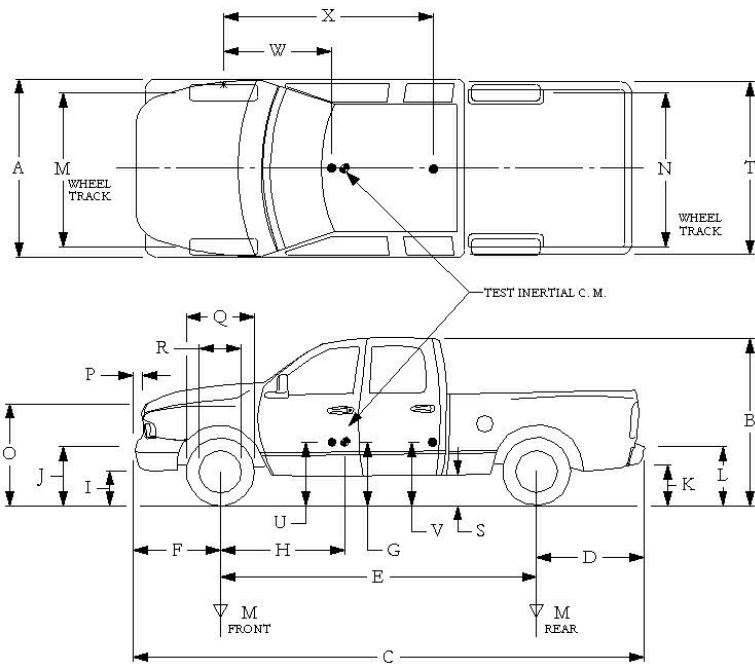

Table F.2. Measurements of Vehicle Vertical CG for Test No. 490026-2-3.

Date: 2016-03-03 Test No.: 490026-2-1/2/3 VIN: 1D7RB1GP5AS126554
 Year: 2010 Make: Dodge Model: Ram 1500
 Body Style: Quad Cab Mileage: 173708
 Engine: 4.7 liter V-8 Transmission: Automatic
 Fuel Level: Empty Ballast: 228 lb (440 lb max)
 Tire Pressure: Front: 35 psi Rear: 35 psi Size: 265/70R17

Measured Vehicle Weights: (lb)			
LF:	<u>1388</u>	RF:	<u>1398</u>
		Front Axle:	<u>2786</u>
LR:	<u>1084</u>	RR:	<u>1144</u>
		Rear Axle:	<u>2228</u>
Left:	<u>2472</u>	Right:	<u>2542</u>
		Total:	<u>5014</u>
			5000 ±110 lb allow ed
Wheel Base:	<u>140.5</u> inches	Track: F:	<u>68.5</u> inches
	148 ±12 inches allow ed	R:	<u>68</u> inches
			Track = (F+R)/2 = 67 ±1.5 inches allow ed
Center of Gravity, SAE J874 Suspension Method			
X:	<u>62.43</u> in	Rear of Front Axle	(63 ±4 inches allow ed)
Y:	<u>0.48</u> in	Left - Right +	of Vehicle Centerline
Z:	<u>28.375</u> in	Above Ground	(minumum 28.0 inches allow ed)

Hood Height: 46.5 inches Front Bumper Height: 27.5 inches
 43 ±4 inches allowed

Front Overhang: 40.0 inches Rear Bumper Height: 29.0 inches
 39 ±3 inches allowed

Overall Length: 227.5 inches
 237 ±13 inches allowed

Table F.3. Exterior Crush Measurements for Test No. 490026-2-3.

Date: 2016-03-03 Test No.: 490026-2-3 VIN No.: 1D7RB1GP5AS126554
 Year: 2010 Make: Dodge Model: Ram 1500

VEHICLE CRUSH MEASUREMENT SHEET¹

Complete When Applicable	
End Damage	Side Damage
Undeformed end width _____ Corner shift: A1 _____ A2 _____ End shift at frame (CDC) (check one) < 4 inches _____ ≥ 4 inches _____	Bowing: B1 _____ X1 _____ B2 _____ X2 _____ Bowing constant $\frac{X1 + X2}{2} = \underline{\hspace{2cm}}$

Note: Measure C₁ to C₆ from Driver to Passenger Side in Front or Rear impacts – Rear to Front in Side Impacts.

Specific Impact Number	Plane* of C-Measurements	Direct Damage		Field L**	C ₁	C ₂	C ₃	C ₄	C ₅	C ₆	±D
		Width** (CDC)	Max*** Crush								
1	Front plane at bumper ht	---	2.5	---	---	---	---	---	---	---	---
	Measurements recorded										
	in inches										

¹Table taken from National Accident Sampling System (NASS).

*Identify the plane at which the C-measurements are taken (e.g., at bumper, above bumper, at sill, above sill, at beltline, etc.) or label adjustments (e.g., free space).

Free space value is defined as the distance between the baseline and the original body contour taken at the individual C locations. This may include the following: bumper lead, bumper taper, side protrusion, side taper, etc. Record the value for each C-measurement and maximum crush.

**Measure and document on the vehicle diagram the beginning or end of the direct damage width and field L (e.g., side damage with respect to undamaged axle).

***Measure and document on the vehicle diagram the location of the maximum crush.

Note: Use as many lines/columns as necessary to describe each damage profile.

Table F.4. Occupant Compartment Measurements for Test No. 490026-2-3.

Date: 2016-03-03 Test No.: 490026-2-3 VIN No.: 1D7RB1GP5AS126554
 Year: 2010 Make: Dodge Model: Ram 1500

OCCUPANT COMPARTMENT DEFORMATION MEASUREMENT

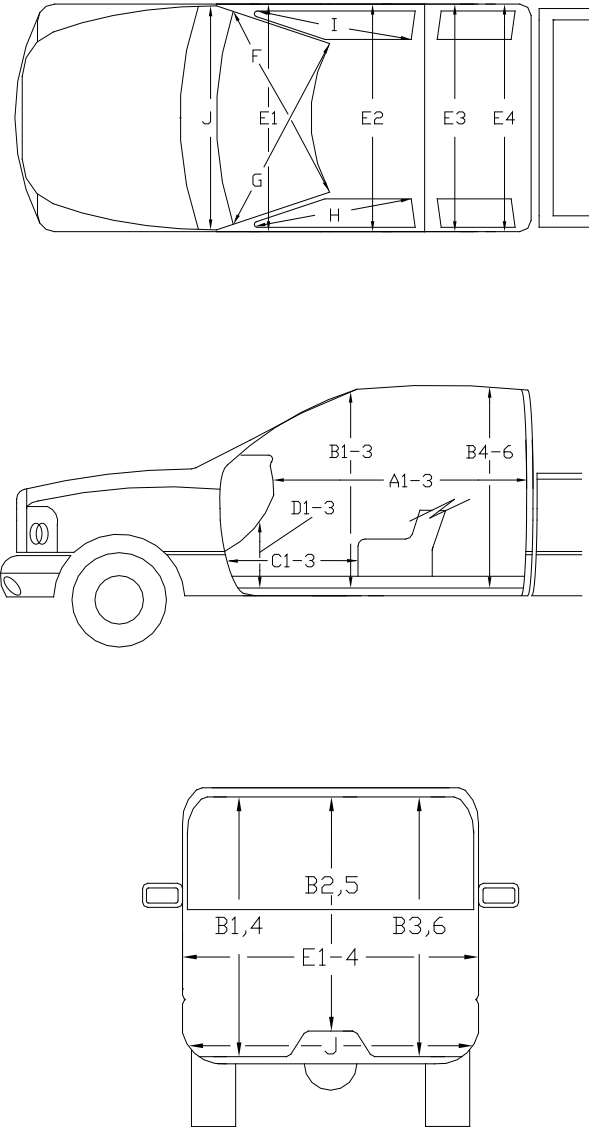

	Before (inches)	After (inches)
A1	65.50	65.50
A2	63.50	63.50
A3	65.50	65.50
B1	45.00	45.00
B2	37.75	37.75
B3	45.00	45.00
B4	39.50	39.50
B5	41.00	41.00
B6	39.50	39.50
C1	26.50	26.50
C2	-----	-----
C3	26.00	26.00
D1	11.25	11.25
D2	-----	-----
D3	11.25	11.25
E1	58.50	58.50
E2	63.50	63.50
E3	63.50	63.50
E4	63.25	63.25
F	59.00	59.00
G	59.00	59.00
H	37.50	37.50
I	37.50	37.50
J*	23.00	23.00

*Lateral area across the cab from driver's side kickpanel to passenger's side kickpanel.

F2 SEQUENTIAL PHOTOGRAPHS



0.000 s

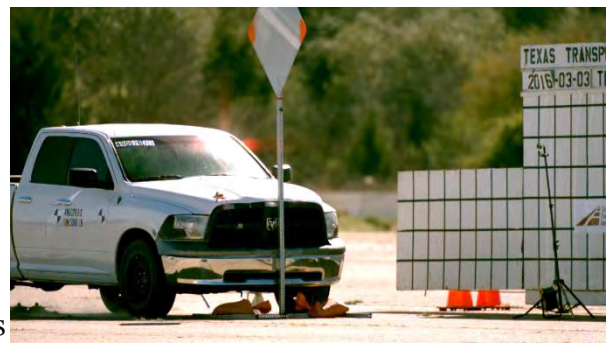

0.030 s



0.060 s



0.090 s

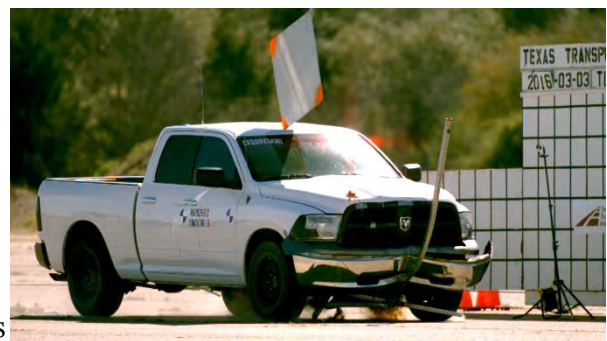

Figure F.1. Sequential Photographs for Test No. 490026-2-3 (Perpendicular and Oblique Views).



0.120 s



0.150 s



0.180 s



0.210 s



Figure F.1. Sequential Photographs for Test No. 490026-2-3 (Perpendicular and Oblique Views) (Continued).

APPENDIX G. CRASH TEST NO. 490026-2-5 (MASH TEST 3-71)

G1 VEHICLE PROPERTIES AND INFORMATION

Table G.1. Vehicle Properties for Test No. 490026-2-5.

Date: 2016-03-11 Test No.: 490026-2-4/5/6/7 VIN No.: KNAD14A35B6916812
 Year: 2011 Make: Kia Model: Rio
 Tire Inflation Pressure: 32 psi Odometer: 95120 Tire Size: P185/65R14
 Describe any damage to the vehicle prior to test: None

• Denotes accelerometer location.

NOTES: None

Engine Type: 4 cylinder
 Engine CID: 1.6 liter
 Transmission Type:
x Auto or _____ Manual
x FWD _____ RWD _____ 4WD
 Optional Equipment:
None

Dummy Data:
 Type: 50th percentile male
 Mass: 165 lb
 Seat Position: Driver

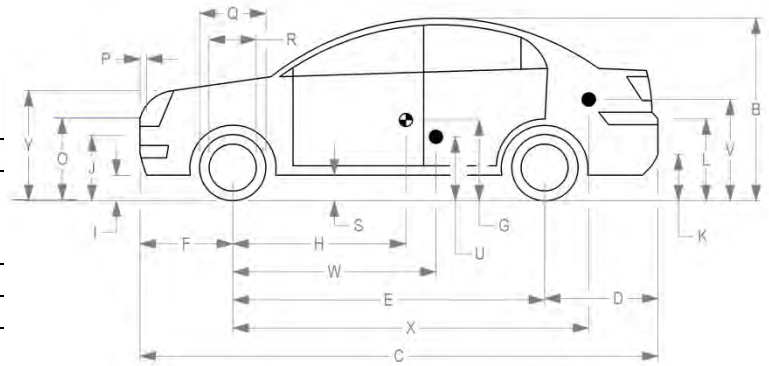
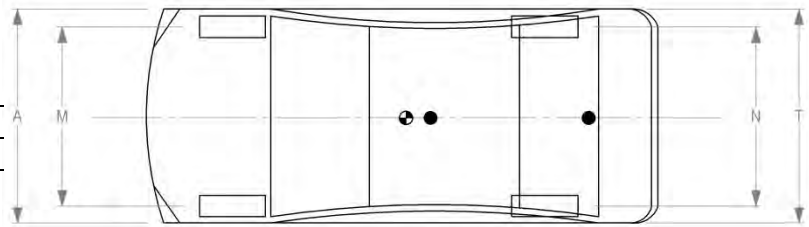

Geometry: inches

A	<u>66.38</u>	F	<u>33.00</u>	K	<u>12.20</u>	P	<u>4.12</u>	U	<u>NA</u>	
B	<u>58.00</u>	G	<u>-----</u>	L	<u>25.00</u>	Q	<u>22.50</u>	V	<u>NA</u>	
C	<u>165.75</u>	H	<u>35.93</u>	M	<u>57.75</u>	R	<u>15.50</u>	W	<u>NA</u>	
D	<u>34.00</u>	I	<u>8.00</u>	N	<u>57.10</u>	S	<u>7.25</u>	X	<u>NA</u>	
E	<u>98.75</u>	J	<u>21.50</u>	O	<u>28.25</u>	T	<u>66.20</u>	Y	<u>27.00</u>	
	Wheel Center Ht Front		<u>11.00</u>		Wheel Center Ht Rear		<u>11.00</u>		W-H	<u>NA</u>

GVWR Ratings:

	Mass: lb	Curb	Test Inertial	Gross Static
Front	<u>1918</u>	<u>1579</u>	<u>1554</u>	<u>1640</u>
Back	<u>1874</u>	<u>900</u>	<u>889</u>	<u>968</u>
Total	<u>3638</u>	<u>2479</u>	<u>2443</u>	<u>2608</u>

Allowable TIM = 2420 lb ±55 lb | Allowable GSM = 2585 lb ± 55 lb

Mass Distribution:

lb LF: 800 RF: 754 LR: 440 RR: 449

Table G.2. Exterior Crush Measurements for Test No. 490026-2-5.

Date: 2016-03-11 Test No.: 490026-2-5 VIN No.: KNAD14A35B6916812

Year: 2011 Make: Kia Model: Rio

VEHICLE CRUSH MEASUREMENT SHEET¹

Complete When Applicable	
End Damage	Side Damage
Undeformed end width _____ Corner shift: A1 _____ A2 _____ End shift at frame (CDC) (check one) < 4 inches _____ ≥ 4 inches _____	Bowing: B1 _____ X1 _____ B2 _____ X2 _____ Bowing constant $\frac{X1 + X2}{2} = \underline{\hspace{2cm}}$

Note: Measure C₁ to C₆ from Driver to Passenger Side in Front or Rear impacts – Rear to Front in Side Impacts.

Specific Impact Number	Plane* of C-Measurements	Direct Damage		Field L**	C ₁	C ₂	C ₃	C ₄	C ₅	C ₆	±D
		Width** (CDC)	Max*** Crush								
1	Front plane at bumper ht	0	0	---	---	---	---	---	---	---	---
	Measurements recorded										
	in inches										

¹Table taken from National Accident Sampling System (NASS).

*Identify the plane at which the C-measurements are taken (e.g., at bumper, above bumper, at sill, above sill, at beltline, etc.) or label adjustments (e.g., free space).

Free space value is defined as the distance between the baseline and the original body contour taken at the individual C locations. This may include the following: bumper lead, bumper taper, side protrusion, side taper, etc. Record the value for each C-measurement and maximum crush.

**Measure and document on the vehicle diagram the beginning or end of the direct damage width and field L (e.g., side damage with respect to undamaged axle).

***Measure and document on the vehicle diagram the location of the maximum crush.

Note: Use as many lines/columns as necessary to describe each damage profile.

Table G.3. Occupant Compartment Measurements for Test No. 490026-2-5.

Date: 2016-03-11 Test No.: 490026-2-5 VIN No.: KNAD14A35B6916812

Year: 2011 Make: Kia Model: Rio

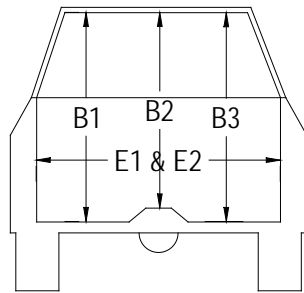
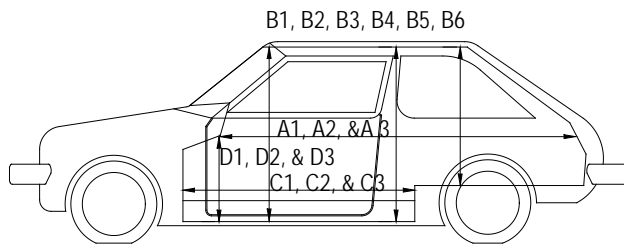
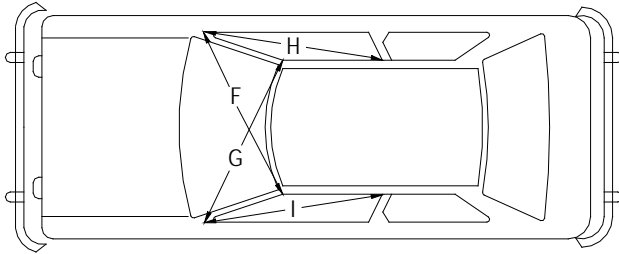

OCCUPANT COMPARTMENT DEFORMATION MEASUREMENT

	Before (inches)	After (inches)
A1	67.50	67.50
A2	67.25	67.25
A3	67.75	67.75
B1	40.50	40.50
B2	35.75	35.75
B3	40.50	40.50
B4	36.00	36.00
B5	32.50	32.50
B6	36.00	36.00
C1	27.25	27.25
C2	-----	-----
C3	27.00	27.00
D1	9.50	9.50
D2	-----	-----
D3	9.25	9.25
E1	51.50	51.50
E2	51.00	51.00
F	51.00	51.00
G	51.00	51.00
H	37.50	37.50
I	37.50	37.50
J*	51.00	51.00

*Lateral area across the cab from driver's side kickpanel to passenger's side kickpanel.

G2 SEQUENTIAL PHOTOGRAPHS



0.000 s

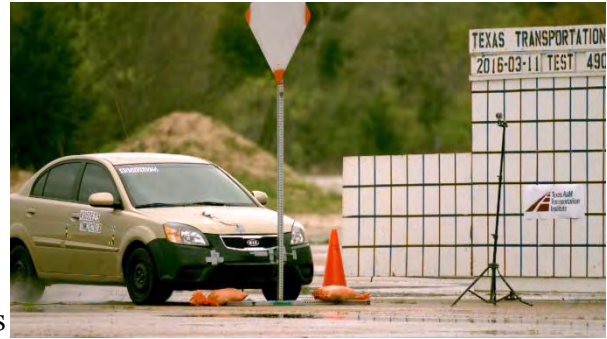

0.030 s

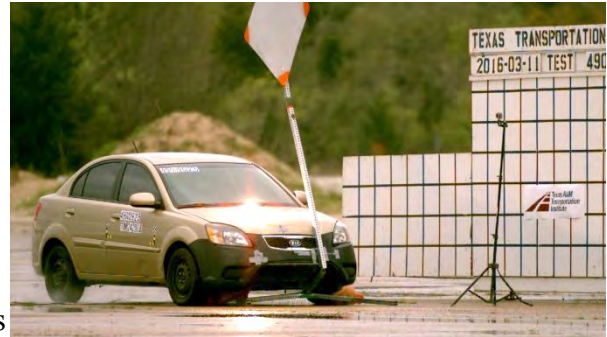

0.060 s



0.090 s

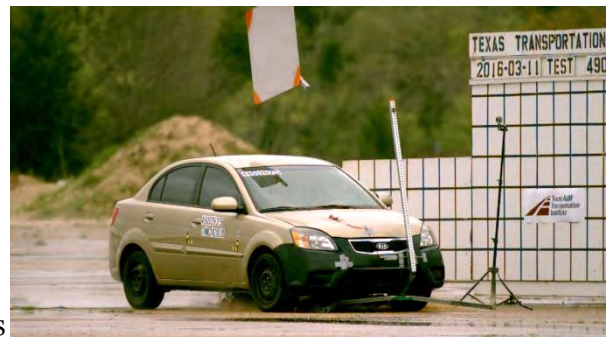

Figure G.1. Sequential Photographs for Test No. 490026-2-5 (Perpendicular and Oblique Views).



0.120 s



0.150 s



0.180 s



0.210 s



Figure G.1. Sequential Photographs for Test No. 490026-2-5 (Perpendicular and Oblique Views) (Continued).

APPENDIX H. CRASH TEST NO. 490026-2-7 (MASH TEST 3-71)

H1 VEHICLE PROPERTIES AND INFORMATION

Table H.1. Vehicle Properties for Test No. 490026-2-7.

Date: 2016-03-11 Test No.: 490026-2-7 VIN No.: KNAD14A35B6916812
 Year: 2011 Make: Kia Model: Rio
 Tire Inflation Pressure: 32 psi Odometer: 95120 Tire Size: P185/65R14
 Describe any damage to the vehicle prior to test: None

• Denotes accelerometer location.

NOTES: None

Engine Type: 4 cylinder
 Engine CID: 1.6 liter
 Transmission Type:
x Auto or _____ Manual
x FWD _____ RWD _____ 4WD
 Optional Equipment:
None

Dummy Data:
 Type: 50th percentile male
 Mass: 165 lb
 Seat Position: Driver

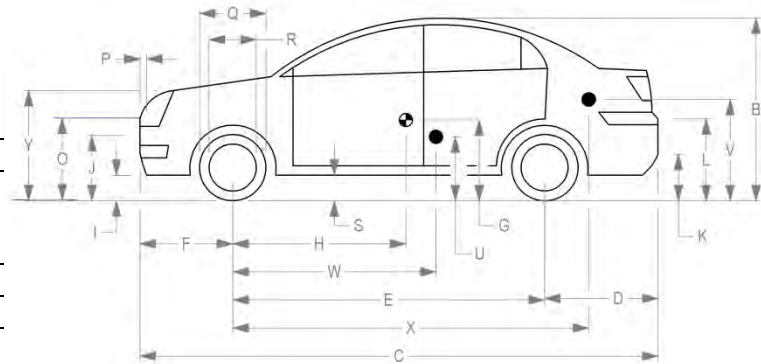
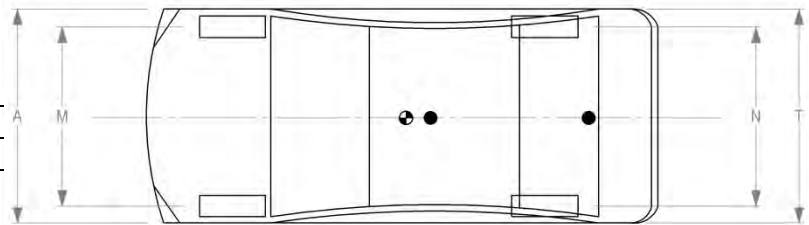

Geometry: inches

A	<u>66.38</u>	F	<u>33.00</u>	K	<u>12.20</u>	P	<u>4.12</u>	U	<u>NA</u>	
B	<u>58.00</u>	G	<u>-----</u>	L	<u>25.00</u>	Q	<u>22.50</u>	V	<u>NA</u>	
C	<u>165.75</u>	H	<u>35.93</u>	M	<u>57.75</u>	R	<u>15.50</u>	W	<u>NA</u>	
D	<u>34.00</u>	I	<u>8.00</u>	N	<u>57.10</u>	S	<u>7.25</u>	X	<u>NA</u>	
E	<u>98.75</u>	J	<u>21.50</u>	O	<u>28.25</u>	T	<u>66.20</u>	Y	<u>27.00</u>	
	Wheel Center Ht Front		<u>11.00</u>		Wheel Center Ht Rear		<u>11.00</u>		W-H	<u>NA</u>

GVWR Ratings:

	GVWR	Mass: lb	Curb	Test Inertial	Gross Static
Front	<u>1918</u>	M_{front}	<u>1579</u>	<u>1554</u>	<u>1640</u>
Back	<u>1874</u>	M_{rear}	<u>900</u>	<u>889</u>	<u>968</u>
Total	<u>3638</u>	M_{Total}	<u>2479</u>	<u>2443</u>	<u>2608</u>

Allowable TIM = 2420 lb ±55 lb | Allowable GSM = 2585 lb ± 55 lb

Mass Distribution:

lb LF: 800 RF: 754 LR: 440 RR: 449

Table H.2. Exterior Crush Measurements for Test No. 490026-2-7.

Date: 2016-03-11 Test No.: 490026-2-7 VIN No.: KNAD14A35B6916812

Year: 2011 Make: Kia Model: Rio

VEHICLE CRUSH MEASUREMENT SHEET¹

Complete When Applicable	
End Damage	Side Damage
Undeformed end width _____ Corner shift: A1 _____ A2 _____ End shift at frame (CDC) (check one) < 4 inches _____ ≥ 4 inches _____	Bowing: B1 _____ X1 _____ B2 _____ X2 _____ Bowing constant $\frac{X1 + X2}{2} = \underline{\hspace{2cm}}$

Note: Measure C₁ to C₆ from Driver to Passenger Side in Front or Rear impacts – Rear to Front in Side Impacts.

Specific Impact Number	Plane* of C-Measurements	Direct Damage		Field L**	C ₁	C ₂	C ₃	C ₄	C ₅	C ₆	±D
		Width** (CDC)	Max*** Crush								
1	Front plane at bumper ht	0	0	---	---	---	---	---	---	---	---
	Measurements recorded										
	in inches										

¹Table taken from National Accident Sampling System (NASS).

*Identify the plane at which the C-measurements are taken (e.g., at bumper, above bumper, at sill, above sill, at beltline, etc.) or label adjustments (e.g., free space).

Free space value is defined as the distance between the baseline and the original body contour taken at the individual C locations. This may include the following: bumper lead, bumper taper, side protrusion, side taper, etc. Record the value for each C-measurement and maximum crush.

**Measure and document on the vehicle diagram the beginning or end of the direct damage width and field L (e.g., side damage with respect to undamaged axle).

***Measure and document on the vehicle diagram the location of the maximum crush.

Note: Use as many lines/columns as necessary to describe each damage profile.

Table H.3. Occupant Compartment Measurements for Test No. 490026-2-7.

Date: 2016-03-11 Test No.: 490026-2-7 VIN No.: KNAD14A35B6916812

Year: 2011 Make: Kia Model: Rio

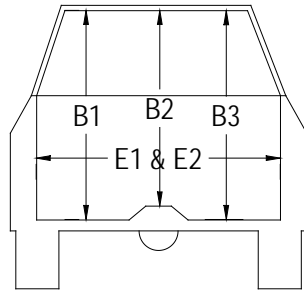
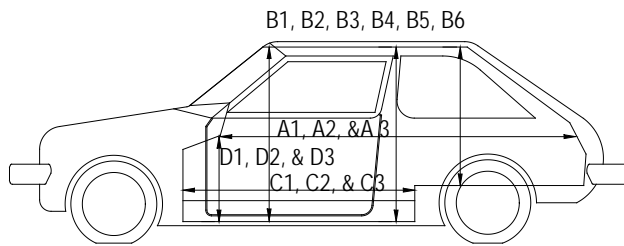
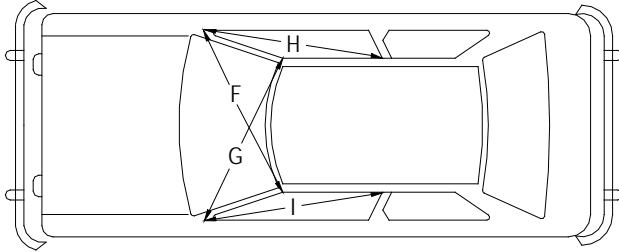

OCCUPANT COMPARTMENT DEFORMATION MEASUREMENT

	Before (inches)	After (inches)
A1	67.50	67.50
A2	67.25	67.25
A3	67.75	67.75
B1	40.50	40.50
B2	35.75	35.75
B3	40.50	40.50
B4	36.00	36.00
B5	32.50	32.50
B6	36.00	36.00
C1	27.25	27.25
C2	-----	-----
C3	27.00	27.00
D1	9.50	9.50
D2	-----	-----
D3	9.25	9.25
E1	51.50	51.50
E2	51.00	51.00
F	51.00	51.00
G	51.00	51.00
H	37.50	37.50
I	37.50	37.50
J*	51.00	51.00

*Lateral area across the cab from driver's side kickpanel to passenger's side kickpanel.

H2 SEQUENTIAL PHOTOGRAPHS



Figure H.1. Sequential Photographs for Test No. 490026-2-7 (Perpendicular and Oblique Views).



0.120 s



0.150 s



0.180 s



0.210 s



Figure H.1. Sequential Photographs for Test No. 490026-2-7 (Perpendicular and Oblique Views) (Continued).

APPENDIX I. CRASH TEST NO. 490026-2-9 (MASH TEST 3-72)

I1 VEHICLE PROPERTIES AND INFORMATION

Table I.1. Vehicle Properties for Test No. 490026-2-9.

Date: 2016-03-03 Test No.: 490026-2-9 VIN No.: 1D7RB1GP5AS126554
 Year: 2010 Make: Dodge Model: Ram 1500
 Tire Size: 265/70R17 Tire Inflation Pressure: 35 psi
 Tread Type: Highway Odometer: 173708
 Note any damage to the vehicle prior to test: None noted

• Denotes accelerometer location.

NOTES: None

Engine Type: V-8
 Engine CID: 4.7 liter

Transmission Type:
 Auto or Manual
 FWD RWD 4WD

Optional Equipment:
None

Dummy Data:
 Type: No dummy
 Mass: NA
 Seat Position: NA

Geometry: inches

A	<u>78.50</u>	F	<u>40.00</u>	K	<u>19.50</u>	P	<u>3.00</u>	U	<u>----</u>
B	<u>74.00</u>	G	<u>28.38</u>	L	<u>29.00</u>	Q	<u>30.50</u>	V	<u>----</u>
C	<u>227.50</u>	H	<u>62.43</u>	M	<u>68.50</u>	R	<u>18.00</u>	W	<u>----</u>
D	<u>47.00</u>	I	<u>12.50</u>	N	<u>68.00</u>	S	<u>13.00</u>	X	<u>----</u>
E	<u>140.50</u>	J	<u>27.50</u>	O	<u>46.50</u>	T	<u>77.00</u>		<u>----</u>
Wheel Center Height Front	<u>14.75</u>	Wheel Well Clearance (Front)	<u>6.00</u>	Bottom Frame Height - Front	<u>17.00</u>				
Wheel Center Height Rear	<u>14.75</u>	Wheel Well Clearance (Rear)	<u>9.25</u>	Bottom Frame Height - Rear	<u>25.50</u>				

RANGE LIMIT: A=78 ±2 inches; C=237 ±13 inches; E=148 ±12 inches; F=39 ±3 inches; G = > 28 inches; H = 63 ±4 inches; O=43 ±4 inches; M+N/2=67 ±1.5 inches

GVWR Ratings:	Mass: lb	Curb	Test Inertial	Gross Static
Front <u>3700</u>	M_{front}	<u>2850</u>	<u>2786</u>	<u>----</u>
Back <u>3900</u>	M_{rear}	<u>2048</u>	<u>2228</u>	<u>----</u>
Total <u>6700</u>	M_{Total}	<u>4898</u>	<u>5014</u>	<u>----</u>

(Allowable Range for TIM and GSM = 5000 lb ±110 lb)

Mass Distribution:

lb LF: 1388 RF: 1398 LR: 1084 RR: 1144

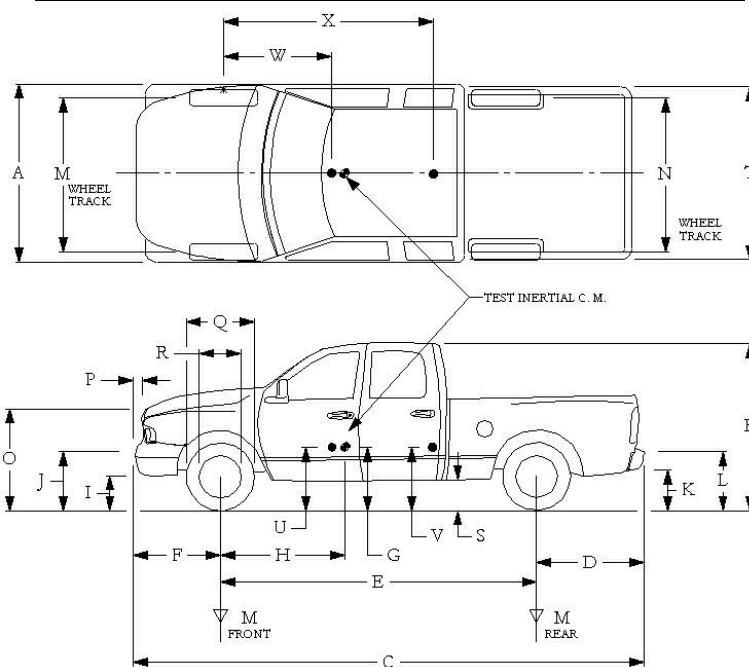

Table I.2. Measurements of Vehicle Vertical CG for Test No. 490026-2-9.

Date: 2016-03-03 Test No.: 490026-2-8 & 9 VIN: 1D7RB1GP5AS126554
 Year: 2010 Make: Dodge Model: Ram 1500
 Body Style: Quad Cab Mileage: 173708
 Engine: 4.7 liter V-8 Transmission: Automatic
 Fuel Level: Empty Ballast: 228 lb (440 lb max)
 Tire Pressure: Front: 35 psi Rear: 35 psi Size: 265/70R17

Measured Vehicle Weights: (lb)			
LF:	<u>1388</u>	RF:	<u>1398</u>
		Front Axle:	<u>2786</u>
LR:	<u>1084</u>	RR:	<u>1144</u>
		Rear Axle:	<u>2228</u>
Left:	<u>2472</u>	Right:	<u>2542</u>
		Total:	<u>5014</u>
			5000 ±110 lb allow ed
Wheel Base:	<u>140.5</u> inches	Track: F:	<u>68.5</u> inches
	148 ±12 inches allow ed	R:	<u>68</u> inches
			Track = (F+R)/2 = 67 ±1.5 inches allow ed
Center of Gravity, SAE J874 Suspension Method			
X:	<u>62.43</u> in	Rear of Front Axle	(63 ±4 inches allow ed)
Y:	<u>0.48</u> in	Left - Right +	of Vehicle Centerline
Z:	<u>28.375</u> in	Above Ground	(minumum 28.0 inches allow ed)

Hood Height: 46.5 inches Front Bumper Height: 27.5 inches
 43 ±4 inches allowed

Front Overhang: 40.0 inches Rear Bumper Height: 29.0 inches
 39 ±3 inches allowed

Overall Length: 227.5 inches
 237 ±13 inches allowed

Table I.3. Exterior Crush Measurements for Test No. 490026-2-9.

Date: 2016-03-03 Test No.: 490026-2-9 VIN No.: 1D7RB1GP5AS126554
 Year: 2010 Make: Dodge Model: Ram 1500

VEHICLE CRUSH MEASUREMENT SHEET¹

Complete When Applicable	
End Damage	Side Damage
Undeformed end width _____ Corner shift: A1 _____ A2 _____ End shift at frame (CDC) (check one) < 4 inches _____ ≥ 4 inches _____	Bowing: B1 _____ X1 _____ B2 _____ X2 _____ Bowing constant $\frac{X1 + X2}{2} = \underline{\hspace{2cm}}$

Note: Measure C₁ to C₆ from Driver to Passenger Side in Front or Rear impacts – Rear to Front in Side Impacts.

Specific Impact Number	Plane* of C-Measurements	Direct Damage		Field L**	C ₁	C ₂	C ₃	C ₄	C ₅	C ₆	±D
		Width** (CDC)	Max*** Crush								
1	Front plane at bumper ht	---	3.5	---	---	---	---	---	---	---	---
	Measurements recorded										
	in inches										

¹Table taken from National Accident Sampling System (NASS).

*Identify the plane at which the C-measurements are taken (e.g., at bumper, above bumper, at sill, above sill, at beltline, etc.) or label adjustments (e.g., free space).

Free space value is defined as the distance between the baseline and the original body contour taken at the individual C locations. This may include the following: bumper lead, bumper taper, side protrusion, side taper, etc. Record the value for each C-measurement and maximum crush.

**Measure and document on the vehicle diagram the beginning or end of the direct damage width and field L (e.g., side damage with respect to undamaged axle).

***Measure and document on the vehicle diagram the location of the maximum crush.

Note: Use as many lines/columns as necessary to describe each damage profile.

Table I.4. Occupant Compartment Measurements for Test No. 490026-2-9.

Date: 2016-03-03 Test No.: 490026-2-9 VIN No.: 1D7RB1GP5AS126554
 Year: 2010 Make: Dodge Model: Ram 1500

OCCUPANT COMPARTMENT DEFORMATION MEASUREMENT

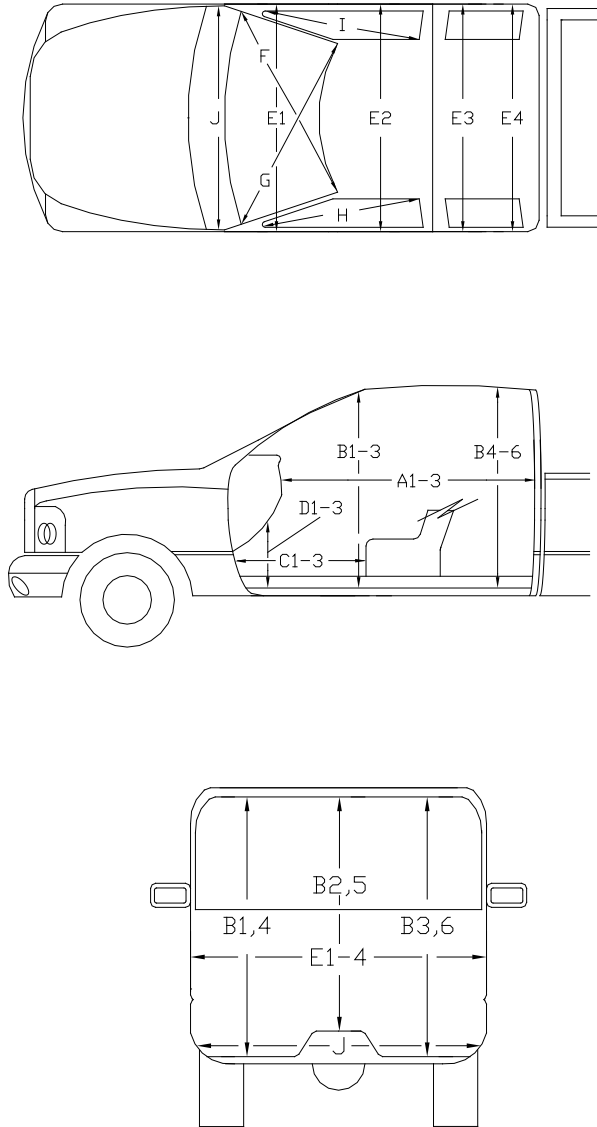

	Before (inches)	After (inches)
A1	65.50	65.50
A2	63.50	63.50
A3	65.50	65.50
B1	45.00	45.00
B2	37.75	37.75
B3	45.00	45.00
B4	39.50	39.50
B5	41.00	41.00
B6	39.50	39.50
C1	26.50	26.50
C2	-----	-----
C3	26.00	26.00
D1	11.25	11.25
D2	-----	-----
D3	11.25	11.25
E1	58.50	58.50
E2	63.50	63.50
E3	63.50	63.50
E4	63.25	63.25
F	59.00	59.00
G	59.00	59.00
H	37.50	37.50
I	37.50	37.50
J*	23.00	23.00

*Lateral area across the cab from driver's side kickpanel to passenger's side kickpanel.

12 SEQUENTIAL PHOTOGRAPHS

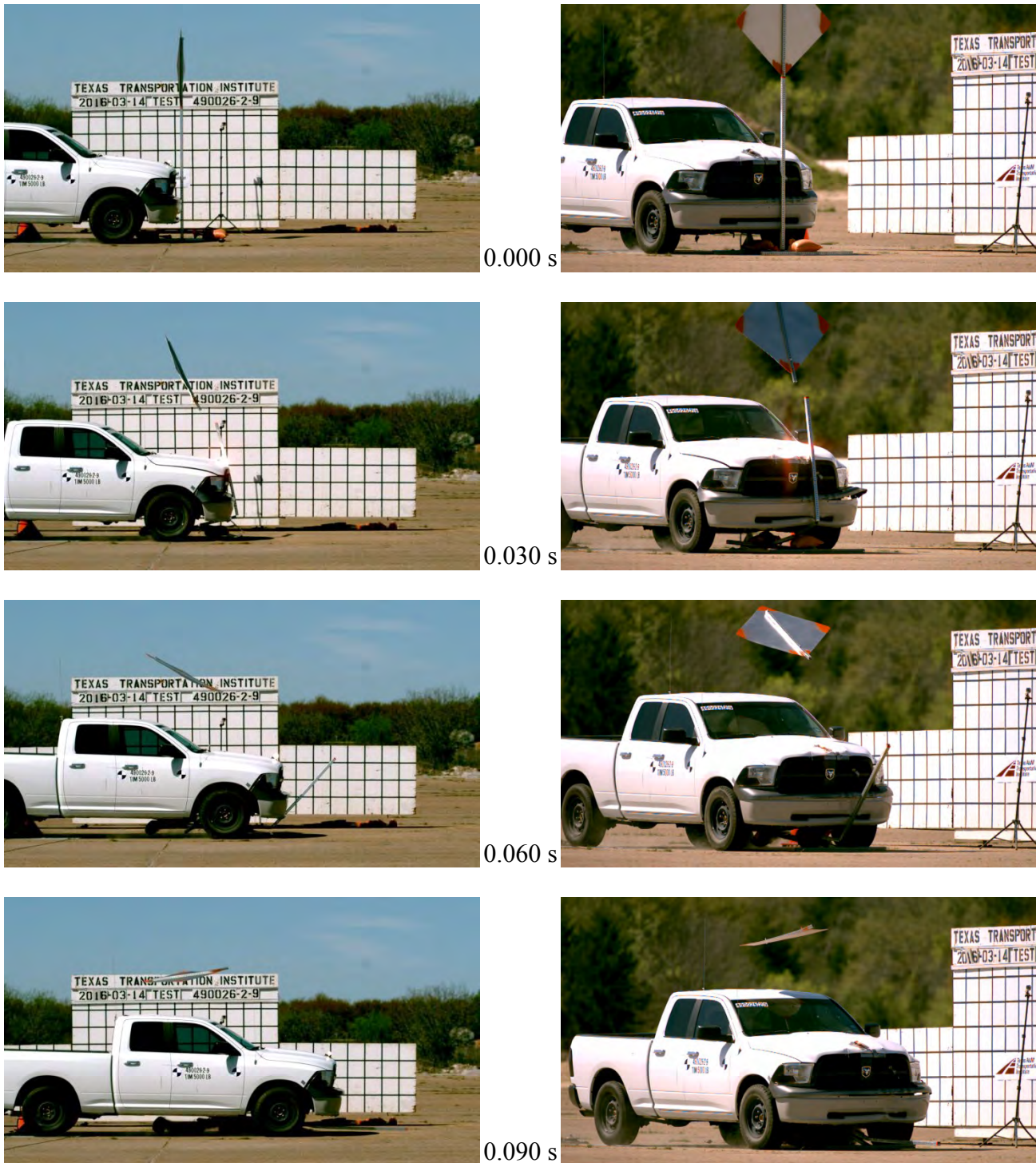
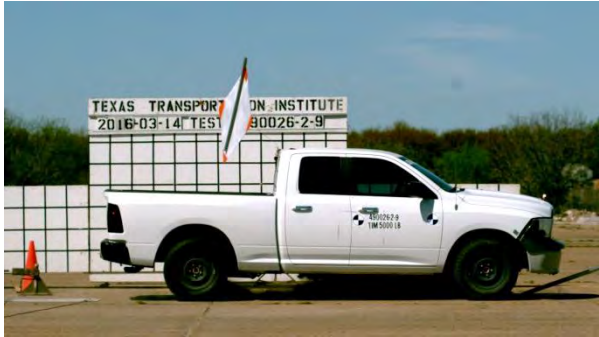

Figure I.1. Sequential Photographs for Test No. 490026-2-9 (Perpendicular and Oblique Views).



0.120 s



0.150 s

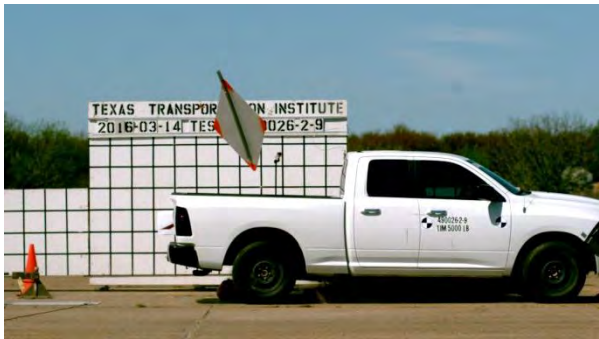

0.180 s

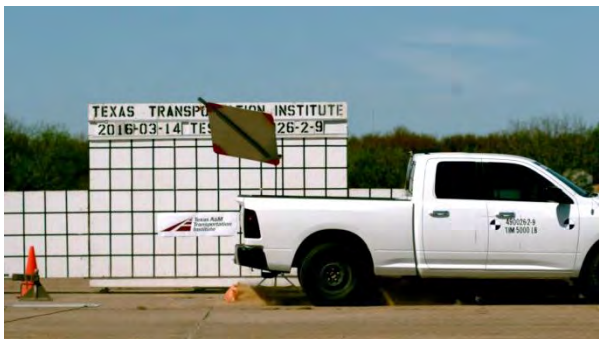

0.210 s



Figure I.1. Sequential Photographs for Test No. 490026-2-9 (Perpendicular and Oblique Views) (Continued).