



---

# Evaluate Potential Impacts, Benefits, Impediments, and Solutions of Automated Trucks and Truck Platooning on Texas Highway Infrastructure: Technical Report

Technical Report 0-6984-R1

---

Cooperative Research Program

TEXAS A&M TRANSPORTATION INSTITUTE  
COLLEGE STATION, TEXAS

in cooperation with the  
Federal Highway Administration and the  
Texas Department of Transportation  
<http://tti.tamu.edu/documents/0-6984-R1.pdf>



1. Report No. FHWA/TX-21/0-6984-R1		2. Government Accession No.		3. Recipient's Catalog No.	
4. Title and Subtitle EVALUATE POTENTIAL IMPACTS, BENEFITS, IMPEDIMENTS, AND SOLUTIONS OF AUTOMATED TRUCKS AND TRUCK PLATOONING ON TEXAS HIGHWAY INFRASTRUCTURE: TECHNICAL REPORT				5. Report Date Published: October 2020	
				6. Performing Organization Code	
7. Author(s) Bjorn Birgisson, Curtis A. Morgan, Matthew Yarnold, Jeffery Warner, Brianne Glover, Maxwell P. Steadman, Sunkari Srinivasa, Shengxin Cai, and Dahye Lee				8. Performing Organization Report No. Report 0-6984-R1	
9. Performing Organization Name and Address Texas A&M Transportation Institute The Texas A&M University System College Station, Texas 77843-3135				10. Work Unit No. (TRAVIS)	
				11. Contract or Grant No. Project 0-6984	
12. Sponsoring Agency Name and Address Texas Department of Transportation Research and Technology Implementation Office 125 E. 11 <sup>th</sup> Street Austin, Texas 78701-2483				13. Type of Report and Period Covered Technical Report: September 2018–August 2020	
				14. Sponsoring Agency Code	
15. Supplementary Notes Project performed in cooperation with the Texas Department of Transportation and the Federal Highway Administration. Project Title: Evaluate Potential Impacts, Benefits, Impediments, and Solutions of Automated Trucks and Truck Platooning on Texas Highway Infrastructure URL: <a href="http://ti.tamu.edu/documents/0-6984-R1.pdf">http://ti.tamu.edu/documents/0-6984-R1.pdf</a>					
16. Abstract This report presents a study that conducted an assessment of the potential impacts, benefits, and impediments of the introduction of automated trucks and truck platooning on Texas highway infrastructure. The assessment included, but was not limited to, identification or review of the following: (a) any needed infrastructure hardening decisions and potential changes in road and bridge design specifications; (b) impacts on the Texas Freight Mobility Plan and the wider designated Texas Highway Freight Network; (c) impacts on statewide planning/Texas Transportation Plan and on metropolitan planning organization and other local/regional plans; (d) overall impacts on the Texas Department of Transportation planning process; (e) national/state/local-level planning/policy impediments and obstacles; (f) potential need for separate/specialized freight transportation facilities; (g) wider impacts of these new technologies on Texas highway infrastructure via a vulnerability analysis at the asset and network levels; and (h) overall infrastructure costs and benefits associated with the introduction of automated and platoon truck technologies on Texas highway infrastructure.					
17. Key Words Autonomous trucks, platoon trucks, freight network, bridges, pavements, vulnerability analysis, graph-based analysis, economic benefits			18. Distribution Statement No restrictions. This document is available to the public through NTIS: National Technical Information Service Alexandria, Virginia <a href="http://www.ntis.gov">http://www.ntis.gov</a>		
19. Security Classif. (of this report) Unclassified		20. Security Classif. (of this page) Unclassified		21. No. of Pages 258	22. Price



**EVALUATE POTENTIAL IMPACTS, BENEFITS, IMPEDIMENTS, AND SOLUTIONS  
OF AUTOMATED TRUCKS AND TRUCK PLATOONING ON TEXAS HIGHWAY  
INFRASTRUCTURE: TECHNICAL REPORT**

by

Bjorn Birgisson, P.E.  
Researcher and Professor

Curtis A. Morgan  
Associate Research Scientist

Matthew Yarnold  
Researcher and Assistant Professor

Jeffery Warner  
Associate Research Scientist

Brianne Glover  
Associate Research Scientist

Maxwell P. Steadman  
Assistant Research Scientist

Sunkari Srinivasa  
Research Engineer

Shengxin Cai  
Graduate Assistant

Dahye Lee  
Graduate Assistant

Texas A&M Transportation Institute

Report 0-6984-R1  
Project 0-6984

Project Title: Evaluate Potential Impacts, Benefits, Impediments, and Solutions of Automated Trucks and  
Truck Platooning on Texas Highway Infrastructure

Performed in cooperation with the  
Texas Department of Transportation  
and the  
Federal Highway Administration

Published: October 2020

TEXAS A&M TRANSPORTATION INSTITUTE  
College Station, Texas 77843-3135



## **DISCLAIMER**

This research was performed in cooperation with the Texas Department of Transportation (TxDOT) and the Federal Highway Administration (FHWA). The contents of this report reflect the views of the authors, who are responsible for the facts and the accuracy of the data presented herein. The contents do not necessarily reflect the official view or policies of FHWA or TxDOT. This report does not constitute a standard, specification, or regulation.

## **ACKNOWLEDGMENTS**

This project was conducted in cooperation with TxDOT and FHWA. The authors thank Joanne Steele, research project manager at the TxDOT Research and Technology Implementation Division, for her excellent guidance and support on the project, as well as James Kuhr, the previous research project manager. The authors would also like to thank the members of the Project Monitoring Committee: Curtis Rokicki, Casey Wells, Loretta Brown, Chad Dabbs, Natnael Asfaw, and Neil Welch. Their active input and discussions were invaluable in the success of this project. In addition, the authors would like to thank Darran Anderson, Kevin Pete, and Caroline Mays for their excellent input and discussions.



# TABLE OF CONTENTS

	Page
<b>List of Figures</b> .....	<b>xi</b>
<b>List of Tables</b> .....	<b>xv</b>
<b>Chapter 1. Introduction</b> .....	<b>1</b>
Background.....	1
Scope of this Report.....	1
Highlights of Findings .....	2
<b>Chapter 2. Literature Review</b> .....	<b>5</b>
Objective.....	5
Potential Impacts of Automated Trucks and Truck Platooning.....	5
Environmental Impacts .....	5
Roadway Capacity Impacts.....	8
Labor Impacts .....	9
Driver Training and Commercial Driver’s License Impacts .....	10
Infrastructure and Land Use Impacts .....	11
Safety Impacts.....	12
Economic Impacts.....	13
Intermodal Freight Operation .....	14
Potential Impediments of Automated Trucks and Truck Platooning .....	14
Cybersecurity Issues .....	14
Privacy Issues.....	15
Liability.....	15
Regulatory.....	16
Identification of Trends in Automated Trucks and Truck Platooning Vehicle Technologies..	17
Base List of Technologies Required for Automated Trucks and Truck Platooning	
Deployment.....	17
New Approaches to Automated Trucks and Truck Platooning Technologies.....	18
<b>Chapter 3. Online Survey and Telephone Interviews</b> .....	<b>21</b>
Introduction.....	21
Survey Analysis .....	21
Type 1 Stakeholders—Trucking Fleet Personnel, Owner-Operators, and Industry	
Associations .....	22
Type 2 Stakeholders—OEMs, Startups, Tier 1 and 2 Suppliers, System Integrators, and	
Other Implementers .....	29
Type 3 Stakeholders—Legislative, Government, Texas Cities/MPO, and State DOT	
Personnel.....	30
<b>Chapter 4. Assessment of Planning and Policy Impacts</b> .....	<b>45</b>
Introduction.....	45
Review of Statewide Planning Process.....	45
TxDOT Planning Process .....	45
Local and Regional Planning Process.....	47
List of Planning Documents .....	50
Statewide.....	50

Metropolitan Planning Organizations .....	50
Other Local/Regional Plans .....	51
Outside Texas.....	51
<b>Chapter 5. Methodology to Develop Guidance for Commercial Truck Platooning .....</b>	<b>53</b>
Simulation Methodology .....	53
Policy Issues .....	53
Findings .....	54
<b>Chapter 6. Assessment of Technical and Performance Impacts on Texas Pavements.....</b>	<b>57</b>
Introduction.....	57
Analysis Framework for Performance Evaluation of Flexible Pavement .....	57
Traffic Data Collection .....	58
Categorization of Traffic Loads .....	58
Axle Load Distribution .....	59
Estimation of Number and Distribution of Axle Loads.....	61
Cost of Installation of Pavement Marking.....	63
Pavement Markings for AV-CV Users.....	66
Climate Model .....	67
Temperature Prediction in Surface Layer .....	67
Suction .....	68
Material Property Prediction Submodels.....	70
Asphalt Concrete Stiffness Aging Model Using Artificial Neural Network Algorithm.....	70
Moisture-Dependent Resilient Modulus of Base and Subgrade .....	71
Pavement Response SubModel.....	72
Effects of Wheel Wander.....	74
Variabilities of Axle Load on Magnitude .....	75
Variabilities of Tire Load on Location .....	77
Wheel-Wander Effects on Cumulative Driving Force of Pavement Distress.....	78
Wheel-Wander Coefficient .....	81
Predictive Models for TDC Initiation and Growth.....	83
TDC Initiation Time Prediction .....	83
TDC Growth Prediction Using ANN Model of J-Integral.....	84
Predictive Model of Pavement ME Design for Rutting and Bottom-Up Cracking .....	87
Rutting Prediction .....	87
Bottom-Up Cracking Prediction .....	92
Results and Discussion for Flexible Pavement.....	93
Top-Down Cracking Analysis .....	93
Rutting Analysis Using Pavement ME Design Model .....	94
Bottom-Up Cracking Analysis Using Pavement ME Design Model.....	95
Performance of Concrete Pavement under Effect of Platooned Traffic .....	96
Jointed Plain Concrete .....	97
CRC Pavement.....	104
Conclusions.....	109
<b>Chapter 7. Assessment of Technical and Performance Impacts on Texas Bridges .....</b>	<b>111</b>
Objective.....	111
Context.....	111
Prior Research.....	112

Background.....	112
Truck Platoon Parameters of Interest to Bridges .....	112
Bridge Load Rating.....	114
Methodology.....	116
Extracting NBI Data .....	116
Identifying Design Methodology .....	117
Calculating Design Live Load Demands .....	118
Determining Bridge Capacity and Dead Load Demands.....	119
Calculating Truck Platoon Live Load Demands.....	121
Calculating Truck Platoon Load Ratings .....	121
Determining Bridge Prioritization .....	123
Results.....	124
Findings .....	128
<b>Chapter 8. Impacts of Truck Platooning and Truck Automation on the Vulnerability of the Texas Highway System .....</b>	<b>131</b>
Objective.....	131
The Impacts of Truck Platooning on the Vulnerability of Texas Pavements.....	131
Policy, Planning, and Investment Implications.....	132
The Impacts of Truck Platooning on the Vulnerability of Texas Highway Bridges .....	132
Policy, Planning, and Investment Implications.....	133
Other Key Project Findings Affecting Policy and Planning.....	133
High-Level Objective and Motivation.....	134
Methodology Framework .....	135
Graph-Based Framework for Assessing Transportation Network Vulnerability.....	135
Application of Graph-Based Framework for Bridge Vulnerability Analysis.....	136
Modeling Transition from Regular Truck Traffic to Automated and Platoon Truck Traffic .....	141
Demonstration of Markov Transition-Based Modeling Framework .....	142
Hardening Options for Pavements .....	144
Texas Freight Network Pavement Case Study .....	149
Analysis of LTPP Pavement Sections.....	149
Texas Freight Network Pavements .....	155
Results and Conclusions .....	160
<b>Chapter 9. Analysis of Overall Economic Impact of Platooning and Truck Automation on Texas Highways .....</b>	<b>161</b>
Objective and Economic Evaluation Framework .....	161
Scenario Development.....	161
Case Study Corridor.....	165
Case Study Corridor Characteristics for Scenario Planning .....	166
Case Cost Element .....	168
Cost Element Discussions .....	169
Benefit-Cost Analysis .....	178
Truck Movements .....	178
Infrastructure Costs.....	179
Safety Benefits .....	180
Environmental Benefits .....	181

Operations Benefits.....	181
Freight Cost Savings .....	183
BCA Results.....	185
Economic Impact Analysis .....	187
<b>Chapter 10. Conclusions and Recommendations .....</b>	<b>191</b>
Determination of State-of-Practice .....	191
Connected and Automated Truck Applications .....	191
Establish Driver Training Program and Labor Standards.....	192
Other Research Needs Identified .....	192
Impacts on Planning and Policy.....	193
Impacts of Platooning and Truck Automation on Texas Infrastructure .....	193
Impacts on Texas Pavements .....	194
Impacts on Texas Bridges .....	194
Other Key Project Findings Affecting Policy and Planning.....	195
Impacts on the Vulnerability of the Texas Highway System Pavements .....	196
Impacts of Truck Platooning on the Vulnerability of Texas Pavements .....	196
Impacts of Truck Platooning on the Vulnerability of Texas Highway Bridges.....	197
Policy, Planning, and Investment Implications from the Pavement and Bridge Network Analyses.....	197
Economic Impact of Platooning and Truck Automation on Texas Highways .....	198
<b>References .....</b>	<b>201</b>
<b>Appendix A. Online Survey Questionnaire .....</b>	<b>207</b>
<b>Appendix B. Pavement Performance Prediction Based on the Surface and Base Type     Combination.....</b>	<b>225</b>
<b>Appendix C. Value of Research Report.....</b>	<b>237</b>

## LIST OF FIGURES

	Page
Figure 2.1. Transportation Energy Consumption Projection. ....	6
Figure 2.2. Percentage Fuel Savings by Different Distance Gaps (5–10). ....	8
Figure 2.3. Percent Travel Time Savings by Headways and Market Penetration Rates (15). ....	9
Figure 3.1. Projected Market Demand in Different Time Frame. ....	23
Figure 3.2. Challenges Related to the Introduction of Automated Truck and Truck Platooning. ....	24
Figure 3.3. Types of Platooning—Allowable Roads. ....	25
Figure 3.4. Complications and Risk Areas during the Transition Phase. ....	26
Figure 3.5. Traffic Volume Conditions to Permit Truck Platooning. ....	27
Figure 3.6. Areas Where Truck Platooning Needs to Disengage. ....	28
Figure 3.7. Types of Cargo for Which Truck Platooning Should Not Be Allowed. ....	28
Figure 3.8. Projected Market Demand for Different Time Frames. ....	30
Figure 3.9. Important Factors in Future DOT Planning for Platooning and Automated Trucks. ....	31
Figure 3.10. Challenges Related to the Introduction of Automated Truck and Truck Platooning. ....	32
Figure 3.11. Types of Platooning-Allowable Roads. ....	32
Figure 3.12. Types of Platooning-Allowable Vehicles. ....	33
Figure 3.13. Preferred Funding Sources for Infrastructure Improvements/Accommodations. ....	33
Figure 3.14. Expected Time Frame of Different Levels of Vehicle Automation. ....	34
Figure 3.15. Complications and Risk Areas during the Transition Phase. ....	36
Figure 3.16. Major Policy Issues Associated with Truck Automation and Platooned Trucks. ....	37
Figure 3.17. Survey Respondents’ Opinion on Current Texas State Programs. ....	38
Figure 3.18. Anticipated Impact of Implementing Technologies on Traditional Infrastructure Funding. ....	38
Figure 3.19. Potential Communication Method between Highway Users and Truck Platooning and Automated Truck Corridors/Segments. ....	40
Figure 3.20. Weather and Visibility Conditions in Which Truck Platooning Should Not Be Permitted. ....	41
Figure 3.21. Traffic Volume Conditions to Permit Truck Platooning. ....	41
Figure 3.22. Areas Where Truck Platooning Needs to Disengage. ....	42
Figure 3.23. Type of Cargo for Which Platooning Trucks Should Not Be Permitted. ....	43
Figure 4.1. TxDOT Planning and Programming Documents (53). ....	47
Figure 4.2. Texas MPOs (54). ....	48
Figure 4.3. Performance-Based Planning Process (55). ....	49
Figure 6.1. Flowchart for the Pavement Performance Analysis Framework Used in the Study. ....	58
Figure 6.2. Annual Axle Load Distribution for Traffic of LTPP Section 48-1050 in 1992. ....	60

Figure 6.3. Cumulative Axle Load Distribution versus Load Intervals for All Categories of LTPP Section 48-1050 in 1992. ....	61
Figure 6.4. Illustration of Heat Transfer Model of Asphalt Pavement. ....	67
Figure 6.5. Annual Temperature Profiles of Texas Section 48-1056 at Different Depths. ....	68
Figure 6.6. GIS-Based Contour Map of Equilibrium Suction. ....	70
Figure 6.7. Comparison of Measured versus Predicted Saturation (%) at 0.1-bar, 0.33-bar, and 15-bar Suction Level for Unbound Granular Base Materials Using the ANN Model: (a) Plastic Soils; (b) Non-plastic Soils (73).....	72
Figure 6.8. Pavement Structure in the Proposed Pavement Response Model. ....	73
Figure 6.9. Finite Element Configuration of Layered System: (a) Geometry; (b) Mesh and Loading. ....	73
Figure 6.10. Comparison of Pavement Surface Radial Stresses $\sigma_r$ Using Python FEM Simulator and COMSOL Software. ....	74
Figure 6.11. Procedures for Pavement Performance Analysis with or without WW with Variation of Tire Load Magnitude and Deviation. ....	75
Figure 6.12. Cumulative Axle Load Distribution versus Load Intervals for All Categories Using Default Class, Axle Type, and Axle Load Distribution. ....	76
Figure 6.13. Number of Axle Load Repetitions versus Load Intervals Based on Annual Truck Traffic of $1 \times 10^6$ for (a) Single and (b) Dual Tire Type.....	77
Figure 6.14. Tire Deviation Distributions for (a) 5,000-lb Tire Load Interval with 86,123 Load Repetitions in Single Tire Category; (b) 9,000-lb Tire Load Interval with 7,761 Load Repetitions in Single Tire Category; (c) 5,000-lb Tire Load Interval with 508,898 Load Repetitions in Dual Tire Category; (d) 13,000-lb Tire Load Interval with 9,153 Load Repetitions in Dual Tire Category. ....	78
Figure 6.15. Illustration of Variation of Each Tire Load on Magnitude and Deviation. ....	79
Figure 6.16. The Driving Force Profiles (tensile strain at AC bottom) Induced by Each Tire Load with (purple curves) and without (black curve) WW.....	80
Figure 6.17. Accumulative Driving Force Profiles ( $\epsilon_t$ at AC bottom) Induced by Annual Tire Load with (purple curve) and without (gray curve) WW.....	81
Figure 6.18. Wheel-Wander Coefficients for TDC, Bottom-Up Cracking (BUC), and Rutting (PD) for 22 Texas LTPP Sections.....	82
Figure 6.19. Modulus Gradient versus Depth of Asphalt Layer Due to (a) Oxidative Aging Effect and (b) Thermal Effect. ....	84
Figure 6.20. Crack Locations and Mesh Details of FEM in Crack and Loading Areas (81).....	86
Figure 6.21. Tire Patch and Tire Load Applied to Pavement Surface. ....	86
Figure 6.22. Typical Plot of J-integral versus Tire Patch for Dual Tire Type and Prediction of J-integral with Any Reasonable Tire Length through Curve Fitting. ....	87
Figure 6.23. Schematic of Rutting Accumulation Method. ....	92
Figure 6.24. Comparison of Predicted TDC Initiation Time for WW and Non-WW Cases.....	94
Figure 6.25. Comparison of Predicted Crack Initiation Time for WW and Non-WW Cases. ....	94
Figure 6.26. Comparison of Predicted Rutting Depth for WW and Non-WW Cases at 20th Year.....	95
Figure 6.27. Rutting Evolution for Pavement Section 48-1076.....	95

Figure 6.28. The Time When Pavement Reaches 25 Percent of BUC for Both WW and Non-WW Cases. ....	96
Figure 6.29. BUC Evolution for Section 48-3729. ....	96
Figure 6.30. Normal and Platooned Traffic Distributions. ....	98
Figure 6.31. Comparison of Predicted Percent of Cracking under Platooned and Normal Distribution Using Pavement ME. ....	101
Figure 6.32. Comparison of Predicted Percent of Cracking under Platooned and Normal Distribution for LTPP Sections (a) 48-3589 and (b) 48-C420. ....	102
Figure 6.33. Comparison of Predicted Percent of Erosion under Platooned and Normal Distribution for LTPP Sections (a) 48-9355 and (b) 48-3003. ....	103
Figure 6.34. Comparison of Percent of Cracking and Faulting Depth per Unit Traffic under Platooned and Normal Distribution for LTPP Sections (a) 48-9355 and (b) 48-3003. ....	104
Figure 6.35. Comparison of Predicted Punchout Number Considering with/without Erosion under Platooned and Normal Distribution Using Pavement ME. ....	106
Figure 6.36. Comparison of Predicted Punchout Number Considering with/without Erosion under Platooned and Normal Distribution for LTPP Sections (a) 48-5323 and (b) 48-3569. ....	107
Figure 6.37. Comparison of Punchout Number per Unit Traffic Considering with/without Erosion under Platooned and Normal Distribution Using Pavement ME. ....	108
Figure 6.38. Comparison of Punchout Number per Unit Traffic Considering with/without Erosion under Platooned and Normal Distribution for LTPP Sections (a) 48-5323 and (b) 48-3569. ....	109
Figure 7.1. Truck-to-Truck Minimum Following Distance in a Platoon (91). ....	113
Figure 7.2. Five-Axle Trucks Considered for Truck Platooning. ....	114
Figure 7.3. AASHTO HL93 and HS20 Live Loading for Simple Spans. ....	119
Figure 7.4. Prestressed Concrete Bridge Comparison for AASHTO Type 3S2 Three-Truck Platoons Spaced at 30 ft. ....	124
Figure 7.5. Ratio of Type 3S2 Truck Platoon Moment to the AASHTO (a) HS20 Moment and (b) HL93 Moment. ....	125
Figure 7.6. Percentage of High-Priority (Level 5) Bridges for Different Span Lengths. ....	126
Figure 7.7. Percentage of High-Priority (Level 5) Bridges for Different Truck Types and Truck Spacing. ....	128
Figure 8.1. Modeling Methodology Used to Quantify Network Vulnerability. ....	135
Figure 8.2. Network-of-Network Representation of Freight Network Components. ....	136
Figure 8.3. Locations of Bridges and Priority Rating under One Platooning Scenario (2 3S2 trucks at 50 ft). ....	137
Figure 8.4. Texas Freight Network Bridge Classification. ....	138
Figure 8.5. Bridges that May Benefit from Attention at Different PR Threshold. ....	138
Figure 8.6. Percentage of Bridges in Possible Need of Attention. ....	139
Figure 8.7. Texas Freight Network at Two Levels of Granularity (Green—Detailed, Blue—Major Roads). ....	140
Figure 8.8. Major Arterial Roads on the Texas Freight Network. ....	140
Figure 8.9. Detailed Texas Freight Network. ....	141
Figure 8.10. Pavement Useful Service Life (RUL) Estimation. ....	143
Figure 8.11. Flexible Pavement Service Life under Normal and Full Platoon Scenarios. ....	144

Figure 8.12. Flexible Pavement Service Life under Full Platoon and HPMA Scenario. ....	145
Figure 8.13. Average RSL under Different Levels of Modifications. ....	146
Figure 8.14. Overall Impact of Truck Platooning on Bridges (based on eigenvalues).....	148
Figure 8.15. Number of Bridges Needing Attention after Full Truck Platoon (based on PR). ....	149
Figure 8.16. Pavement Remaining Service Life under Non-platoon and Platoon Scenarios. ....	150
Figure 8.17. RSL Estimation under Different Rutting Thresholds. ....	151
Figure 8.18. Average RSL under Different Rutting Thresholds.....	153
Figure 8.19. RSL Estimation Based on Rutting and AADTT. ....	153
Figure 8.20. Average RSL for Different Pavement Types. ....	154
Figure 8.21. LTPP Pavement Sections for Texas and Their Classification (source: FHWA). ....	155
Figure 8.22. AADTT in Road Classification Texas Freight Network (the year 2016). ....	156
Figure 8.23. Average AADTT by Road Type in Texas Freight Network. ....	156
Figure 8.24. Flexible Pavement Sections and AADTT Histogram in Texas Freight Network.....	157
Figure 8.25. RSL Estimation Based on Rutting for Flexible Pavements in the Texas Highway Freight Network. ....	157
Figure 8.26. RSL Estimation Based on BUC for Flexible Pavements in the Texas Highway Freight Network. ....	158
Figure 8.27. RSL Estimation Based on TDC for Flexible Pavements in the Texas Highway Freight Network. ....	158
Figure 8.28. RSL Estimation for Rigid Pavements in Texas Highway Freight Network.....	159
Figure 8.29. Texas Odessa District Highway Freight Network.....	160
Figure 9.1. Scenario Development Base Case and Near-Term Period. ....	163
Figure 9.2. Scenario Development Midterm and Long-Term Periods. ....	164
Figure 9.3. Candidate Case Study Corridors. ....	165
Figure 9.4. Annual Platoons over 30-Year Study Period.....	168
Figure 9.5. Pavement Surface Type Histogram for the Study Region.....	174
Figure 9.6. Pavement Base Type Histogram for the Study Region. ....	174
Figure 9.7. Low-Growth Scenario Discounted Benefits Over Time. ....	186
Figure 9.8. High-Growth Scenario Discounted Benefits Over Time.....	187



## LIST OF TABLES

	Page
Table 2.1. Summary of Publicly Available Platooning Test Results and Configurations.....	7
Table 3.1. Number of Survey Respondents by Stakeholder Type.....	22
Table 3.2. SAE Automation Levels (52). .....	35
Table 3.3. Recommended Public Agency Actions to Design Effective Policies and Accelerate the Adoption of Technologies.....	39
Table 5.1. Policy Issues for Truck Platooning.....	54
Table 6.1. Vehicle Categories Classified by Vehicle Class, Axle Type, and Number of Tires (57).....	59
Table 6.2. Default Normalized Vehicle Class Distribution Factor (57). .....	61
Table 6.3. Typical Number of Axles for Each Vehicle (57).....	62
Table 6.4. Typical Characteristics for Axle Types in Each Traffic Category (58).....	62
Table 6.5. Default Cumulative Axle Load Distribution versus Load Intervals for Each Traffic Category (57). .....	63
Table 6.6. Matrix of Material and Costs and Life Cycle (59).....	65
Table 6.7. Cost of Installation (\$mi/yr) (63).....	66
Table 6.8. List of Input and Output Parameters of SWCC ANN. ....	70
Table 6.9. Input Parameters for 1999 Dynamic Modulus ANN Predictive Model. ....	71
Table 6.10. Input Parameters for Resilient Modulus ANN Predictive Model (73).....	72
Table 6.11. Resilient Moduli of Base and Subgrade Layers for Selected LTPP Sections in Texas Calculated by SWCC and Resilient Modulus ANN Models.....	72
Table 6.12. Material and Structure Inputs in the FEM (81).....	86
Table 6.13. Required Input Parameters and Outputs for Trained ANN. ....	87
Table 6.14. Fatigue Cracking Calibration Coefficients. ....	99
Table 6.15. Erosion Calibration Coefficients. ....	101
Table 6.16. Punchout Calibration Coefficients. ....	106
Table 7.1. AASHTO Inventory Load Rating Summary for Prestressed Concrete Bridges.....	118
Table 7.2. AASHTO Inventory Load Rating Summary for Steel Girder Bridges.....	118
Table 7.3. Condition Factors.....	123
Table 7.4. Prioritization Categories. ....	124
Table 7.5. Prioritization Results for Two-Truck Platoons (select vehicles) at 30- and 40-ft Spacing.....	126
Table 7.6. Comparison of Two-Truck versus Three-Truck Results for Type 3S2 Platoons (30-ft Spacing). ....	127
Table 7.7. Prioritization Results Comparison between Concrete and Steel Bridges. ....	127
Table 8.1. Connectivity of Major Arterial Highway Network under Different Bridge Condition Scenarios. ....	140
Table 8.2. Connectivity of Detailed Freight Network under Different Condition Scenarios. ....	141
Table 8.3. Summary of the Pavement Transition Matrix under Different Scenarios. ....	145
Table 8.4. Possible Transition Scenarios for the Bridges in Texas Freight Network.....	146
Table 8.5. Transition Matrix under Different Platooning Scenarios. ....	147
Table 8.6. RSL under Different Rutting Thresholds.....	152

Table 8.7. Relationship between AADTT and RSL for Flexible Pavements. ....	153
Table 8.8. Pavement Types, Number, and Performance Indicator. ....	154
Table 9.1. Time Periods Used for Scenario Analysis. ....	161
Table 9.2. Study Corridor Travel Time Components. ....	166
Table 9.3. Study Corridor Trip Time. ....	166
Table 9.4. TFMP Texas Freight Flow Patterns. ....	167
Table 9.5. Environmental Assumptions. ....	169
Table 9.6. Estimated Reduction in Annual Crashes with Adoption of Autonomous Trucking. ....	171
Table 9.7. Accident Cost by Type. ....	171
Table 9.8. Cost Elements Utilized in Economic Evaluation. ....	172
Table 9.9. Rehabilitation Cost Estimation for Two Types of Pavements. ....	176
Table 9.10. Rehabilitation and Resurfacing Cost Estimation under Different Scenarios. ....	177
Table 9.11. Infrastructure Costs Low Growth. ....	180
Table 9.12. Crash Assumptions. ....	180
Table 9.13. Safety Benefits. ....	180
Table 9.14. Emissions Assumptions. ....	181
Table 9.15. Environmental Benefit Analysis. ....	181
Table 9.16. Undiscounted Operations Benefit Components. ....	182
Table 9.17. Total Operations Benefits. ....	182
Table 9.18. Fuel Cost Assumptions. ....	182
Table 9.19. Idle Truck Assumptions. ....	183
Table 9.20. Freight Benefits. ....	184
Table 9.21. Low-Growth Scenario Results. ....	185
Table 9.22. High-Growth Scenario Results. ....	185
Table 9.23. Estimated Economic Impact Summary (2.4 percent growth factor). ....	188
Table 9.24. Top 10 Industries Impacted. ....	188
Table 9.25. Estimated Tax Impact Summary (2.4 percent growth factor). ....	189
Table 9.26. Estimated Economic Impact Summary (3.5 percent growth factor). ....	189
Table 9.27. Estimated Tax Impact Summary (3.5 percent growth factor). ....	190

# **CHAPTER 1. INTRODUCTION**

## **BACKGROUND**

This study assessed the potential impacts, benefits, and impediments of the introduction of automated trucks and truck platooning on Texas highway infrastructure. In cases where the research team identified negative impacts or impediments to the introduction of automated trucks and truck platooning, the researchers also identified potential solutions that may promote the successful introduction of automated trucks and truck platooning on Texas highway infrastructure.

The results from this study will aid the Texas Department of Transportation (TxDOT) in understanding the potential impacts, benefits, impediments, and solutions of automated trucks and truck platooning on the Texas highway infrastructure and may allow TxDOT's strategy and transportation planning and project teams to proactively plan and anticipate the various issues associated with the introduction of these new technologies on Texas highway infrastructure.

The results from this research project are documented in this report, which summarizes the benefits, impediments, and solutions for successfully deploying new automated and truck platooning technologies. The findings may form the basis for planning decisions by TxDOT to ensure that engineers and planners make the right decisions that result in longer-lasting infrastructure that is prepared for the coming introduction of truck automation and platooning technologies.

## **SCOPE OF THIS REPORT**

The research findings in this report are documented in eight chapters, including this introductory chapter. Chapter 2 presents the results from a literature review, and Chapter 3 discusses the results of an online survey that was performed to engage with industry and other key stakeholders. The results from these two chapters served to establish the current state of practice of truck automation and platooning, as well as identify key research and development gaps. Chapter 4 reports the findings from an assessment of the planning and policy impacts for TxDOT that may occur as platooning and automated trucks are introduced on Texas highways under a variety of scenarios. The research team reviewed the planning process of TxDOT, metropolitan planning organizations (MPOs), and other local/regional-level plans. Also, all levels of statewide planning documents, including the Texas Freight Mobility Plan (TFMP), Texas Transportation Plan (TTP), MPOs' Metropolitan Transportation Plan (MTP), and individual MPO Transportation Improvement Plans (TIPs) were cataloged and reviewed. The research team also reviewed strategic planning documents from other states focused on automated and connected vehicle impacts in order to identify lessons learned or exemplary practices. Planning impacts on Texas's highway network were also evaluated under the platooning and automated truck scenarios identified and used during the scenarios as a basis for the economic analysis.

Chapter 5 presents the methodology used to develop operational guidance for commercial truck platooning using traffic flow simulations. The results presented include operational improvements in road geometric design and the introduction of dedicated truck lanes on minimizing traffic congestion due to the introduction of automated and platoon trucks. Chapters 6 and 7 report on the assessment of potential technical and performance impacts of platooning and truck automation on Texas pavements and bridges, respectively. The results presented in Chapter 6 include a comprehensive analysis framework for performance evaluation of pavement performance quantified in terms of changes in service life for traditional and autonomous trucks with and without lateral wheel wandering. Similarly, the results presented in Chapter 7 include a high-level analytical investigation to identify the impact of future truck platoons on the Texas bridge inventory.

Chapter 8 presents the results from a network-level analysis on the impacts of truck platooning and truck automation on the vulnerability of the Texas Highway Freight System. The researchers used the results from the network-level vulnerability analysis to evaluate the overall economic benefits and costs to the economy of Texas, as discussed in Chapter 9. Chapter 10 presents conclusions and key recommendations from this study.

Appendix A lists the online survey questionnaire used in the study, and Appendix B presents the technical details of the pavement performance predictions included in Chapter 7. Finally, Appendix C presents the value of the research performed in this study.

## **HIGHLIGHTS OF FINDINGS**

The research results from this project are highlighted below:

- The results from the literature review and the online survey showed that further testing and understanding of truck platooning and automated truck technologies under various operational conditions is necessary for successful implementation.
- Truck automation and platooning could result in the following reduction in pavement service life:
  - For flexible pavements, a 22 percent reduction in average service life was observed for top-down cracking; a 21 percent reduction in average service life was observed for bottom-up cracking; and a 9 percent reduction in average service life was observed for rutting.
  - For concrete pavements, the results also showed significant reduction in pavement service life for all concrete pavement types, with jointed reinforced concrete pavements having the largest reduction in service life.
- The research identified two possible pavement hardening scenarios: (a) building dedicated truck lanes; and (b) hardening paved surfaces using polymer-modified asphalt.
- The bridge vulnerability study found that (a) truck gap spacing had a moderate impact on bridge vulnerability; (b) the number of trucks in a platoon had a minor impact, with the

exception of very long-span structures in poor condition; and (c) bridge material (steel vs. concrete) had a minor impact, while the bridge generation (i.e., the generation of the building code used to design the bridge) had a significant impact.

- The main findings from the study on the impacts of road geometric design included:
  - Restricting platooning trucks on the right lane adversely affected freeway performance. Platoons should not be restricted to right lanes only.
  - Corridors with level-of-service (LOS) C or better are best suited for testing platooning. Therefore, initial testing of truck platoons should occur in more rural areas.
  - Platoons should not be required to move left when approaching the ramp. This creates unnecessary lane changing at low volume levels. The results also showed that cooperative lane changing by platoon trucks to accommodate merging vehicles did not improve freeway performance.
  - It is preferable to select corridors that provide an auxiliary lane for the ramps. Weaving length is the deterring factor when selecting a corridor for truck platooning. Thus, it is preferable to select corridors with weaving sections that are greater than 1,000 ft in length.
- The economic analysis of the overall potential costs and benefits to the State of Texas from autonomous and platoon truck traffic found that the discounted net present value was \$1.9 billion in the low-growth scenario and \$2.4 billion in the high-growth scenario. The benefit-cost ratio was 6.62:1 in the low-growth scenario and 8.42:1 in the high-growth scenario, meaning that for every \$1 spent, there are \$8.42 of benefits.

The implications of the findings presented in this report are summarized below. The policy, planning, and/or investment implications of the pavement network analysis indicate consideration of the following:

- Introducing dedicated hardened freight routes and/or truck lanes with high polymer modification of asphalt concrete pavements.
- Not constructing future jointed reinforced concrete pavements on future autonomous/platoon truck highway lanes.
- Specifying how much wheel wander should be required by truck automation and platoon truck companies in order to negate the negative effects of truck automation.
- Introducing guidelines for platoon truck weight distributions.
- Not restricting platoons to right lanes only.
- Performing initial testing of truck platoons in more rural areas.
- Not introducing cooperative lane changing by platoon trucks to accommodate merging vehicles because it did not improve freeway performance.
- Adding longer auxiliary lanes for the ramps on corridors supporting autonomous and platoon truck traffic.



## **CHAPTER 2. LITERATURE REVIEW**

### **OBJECTIVE**

This literature review, Task 2 of the project, focuses on identifying national and international studies on the potential impacts, benefits, impediments, and solutions for automated truck and truck platooning technologies. Trends in vehicle technologies for deployment of automated truck and truck platooning are also identified.

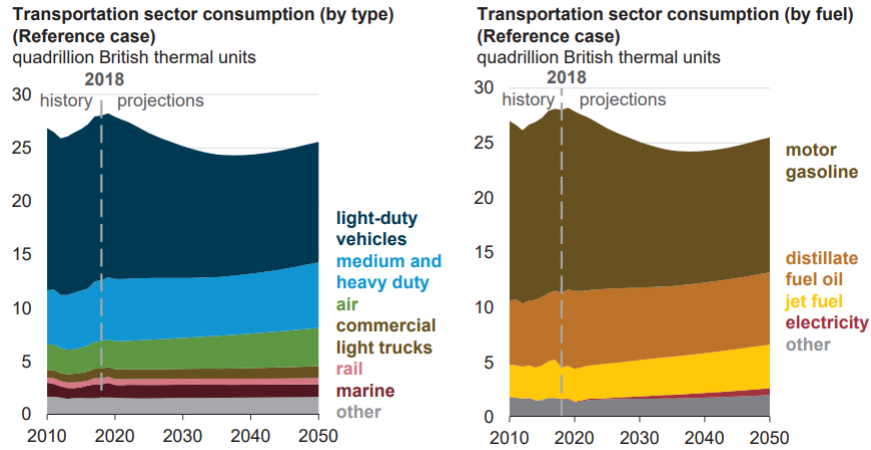
### **POTENTIAL IMPACTS OF AUTOMATED TRUCKS AND TRUCK PLATOONING**

In 2017, 32 percent of fatal crashes involving large trucks reported at least one driver-related factor, with speeding being the leading driver-related factor. Fatigue, alcohol, and illness-related impairments also were factors in 4 percent of all large truck fatal crashes in 2017 (1). Vehicle automation systems are devised to minimize such human-influenced mistakes, including distraction or inattention, alcohol-impaired driving, and careless driving. Thus, significant prevention of loss of life and monetary savings are expected from the implementation of automated and connected trucks.

Connected and autonomous vehicles (CAVs), especially passenger vehicles, have been studied extensively in the past decades. While automated and connected trucks share some core benefits with CAVs, operating trucks is radically different from operating passenger vehicles, and considering other aspects is required, including labor, roadway capacity, and infrastructure. In this section, existing studies on automated truck and truck platooning technologies are summarized by study areas. The study areas describe various benefits and impacts of adopting automated truck and truck platooning technology from freight planning perspectives, including environment, roadway capacity, labor, infrastructure, safety, and economy.

#### **Environmental Impacts**

Medium- and heavy-duty trucks consumed 26 percent of the fuel used on US highway systems in 2017, which is approximately 45.9 billion gal (2). Considering the amount of fuel consumption per millions of vehicle miles traveled, light-duty vehicles consume 3.4 times more fuel than medium- and heavy-duty trucks (2). The transportation sector represented 28 percent of total US greenhouse gas (GHG) emissions, and medium- and heavy-duty trucks accounted for 23 percent of the sector (3). According to the US Energy Information Administration (EIA), overall fuel consumption from the transportation sector peaked in 2018, and heavy-duty vehicles' energy consumption and related diesel usage will remain approximately at the same level throughout the next 30 years, as shown in Figure 2.1 (4).



**Figure 2.1. Transportation Energy Consumption Projection.**

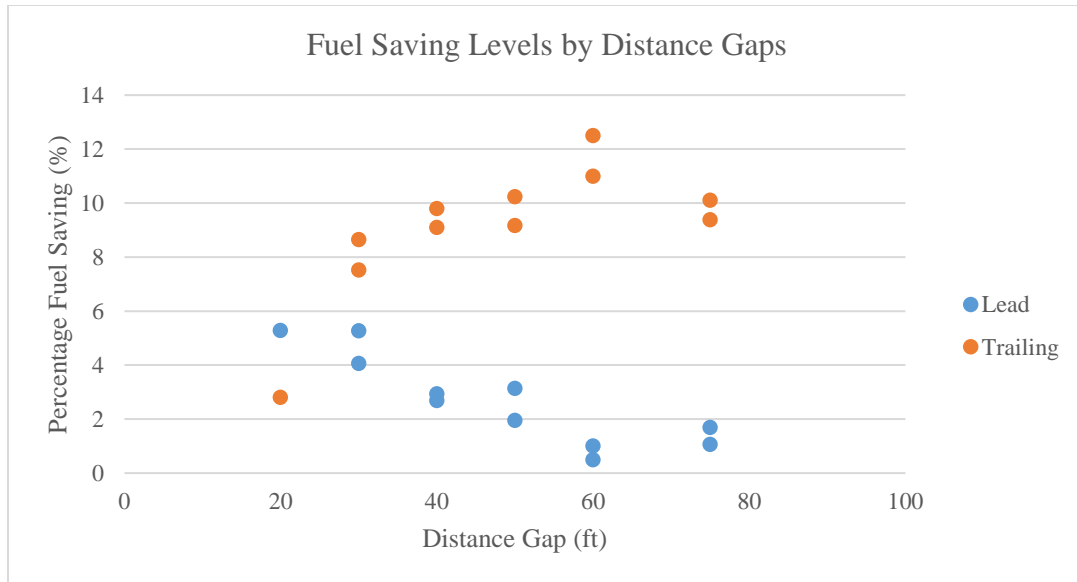
Research has shown that truck platooning and automation can lead to fuel consumption reduction and advanced engine efficiency that will eventually create substantial environmental benefits. In theory, truck platooning can operate with less headway, thereby reducing aerodynamic drag that results in fuel savings and emission reductions. Various tests with Class 8 trucks in the United States and other countries have quantified the environmental benefits of truck platooning, and their configurations are summarized in **Table 2.1**.



**Table 2.1. Summary of Publicly Available Platooning Test Results and Configurations.**

	Gap (ft)	Speed (mph)	Weight (lb)	Lead (%)	Middle (%)	Trailing (%)	Details
(5)	60	65	65,000	0.5	7.5	11	<ul style="list-style-type: none"> <li>- Three Volvo VNL 440 model Class 8 truck tractors</li> <li>- Default adaptive cruise control (ACC) built-in by Volvo deactivated</li> <li>- 4-mi closed-loop test track</li> <li>- Two 1-mi straight sections, semicircular banked curves (each 1-mi long)</li> </ul>
	60	65	65,000	1.0	9.5	12.5	
	144	65	65,000	0	6	9.5	
	144	65	65,000	0.2	7	10	
(6)	30	65	65,000	5.27	0	8.65	<ul style="list-style-type: none"> <li>- Peterbilt 579 tractors and 53-ft trailers</li> <li>- Prototype platooning system by Peloton Inc.</li> <li>- 7.5-mi oval test track</li> <li>- Four asphalt lanes and banked turns (radius of 2,400 ft)</li> </ul>
	40	65	65,000	2.94	0	9.80	
	50	65	65,000	1.95	0	10.24	
	75	65	65,000	1.07	0	10.11	
	150	65	65,000	0.38	0	8.66	
(7)	30	55	65,000	4.33	0	8.38	<ul style="list-style-type: none"> <li>- Peterbilt Class 8 tractor-trailers</li> <li>- Prototype platooning system by Peloton Inc.</li> <li>- Continental Tire Uvalde Proving Grounds track</li> <li>- Three-lane wide</li> <li>- 8.5-mi oval with 1-mi radius turns and a 1.1-mi straightaway between the turns</li> </ul>
	50	55	65,000	2.22	0	9.72	
	20	65	65,000	5.28	0	2.81	
	30	65	65,000	4.06	0	7.53	
	40	65	65,000	2.69	0	9.1	
	50	65	65,000	3.14	0	9.17	
	75	65	65,000	1.69	0	9.39	
	30	70	65,000	4.42	0	4.62	
50	70	65,000	2.23	0	8.36		
(8)	16	50	29,000	9	22.5	16	<ul style="list-style-type: none"> <li>- An automated platoon of three heavy trucks and one light truck</li> </ul>
	33	50	29,000	3.3	19	16.5	
	39	50	29,000	2.5	17	16.2	
	49	50	29,000	1	15.1	16.5	
	66	50	29,000	0	12	15	
(9)	10	55	29,000	9.2	0	11.6	<ul style="list-style-type: none"> <li>- Freightliner 2001 Century Class Tractor-trailers</li> <li>- Operated on an unused runway at Crows Landing, CA</li> <li>- Averaged the data while traveling in both directions over the same central strip of runway</li> <li>- Canceled the effect of runway slope and partially canceled the effect of wind</li> </ul>
	13	55	29,000	9.1	0	12.2	
	20	55	29,000	7.1	0	9.2	
	26	55	29,000	5.6	0	10.8	
	33	55	29,000	6	0	10	
(10)	16	53	Missing Data	7.5	0	16	<ul style="list-style-type: none"> <li>- Two trucks and three cars in the following order: (1) Volvo FH12 Rigid Truck, (2) Volvo FH12 Rigid Truck, (3) Volvo S60, (4) Volvo V60, and (5) Volvo XV60</li> <li>- Four-lane wide</li> <li>- Oval-type track with an 80% bank on each curve</li> </ul>
	20	53		8.4	0	14	
	23	53		7.5	0	12.5	
	26	53		7	0	12.1	
	29	53		5.2	0	10	
	33	53		5.4	0	9.9	
	39	53		3.7	0	8	
	49	53		1.3	0	8.1	

Figure 2.2 shows the different levels of fuel savings (percentage) by various distance gaps, according to **Table 2.1**. For consistency, the figure only considers fully loaded trucks (65,000 lb) traveling 65 mph. The trailing truck’s fuel-saving levels keep increasing until the distance between the lead and the trailing truck reaches 60 ft, while the leading truck’s fuel savings show a completely opposite trend.



**Figure 2.2. Percentage Fuel Savings by Different Distance Gaps (5–10).**

A concern exists that each vehicle benefits from different levels of energy savings. Such conflicts of interest are problematic, especially when all platooned vehicles do not belong to one owner or when trucks are trying to platoon ad hoc. The instability of the platoon will further affect traffic flow efficiency (11, 12). To handle the proper redistribution of benefits between platooning participants, a fair benefit allocation mechanism can be applied. In addition, the mechanism is expected to secure the stability of the identified optimal platoon system (12).

Conversely, some argue that increasing truck volume due to the adoption of new technologies could lead to even higher emissions (13). A report recently published by the New York State Department of Transportation (NYSDOT) also claimed that the results from a prototype platooning system showed that the cooling fan run time increases at shorter following distances because of reduced frontal airflow and increased coolant temperatures. Consequently, the cooling fan has to operate more frequently to maintain engine temperatures, which increases fuel consumption eventually (14). Therefore, the contrary effects of truck platooning and automation technologies need to be evaluated thoroughly in future studies.

### **Roadway Capacity Impacts**

A significant impact on infrastructure capacity is expected with the adoption of automated trucks and truck platooning. In theory, automated and platooned trucks can be programmed to reduce perception-reaction time, allow faster braking and speed adjustment, and use optimized route choices. Since truck platooning technology will require less headway than conventional truck operations, capacity on the interstate and rural highways might increase (13).

100% Peak Hour Volume – Travel Time Benefit

Headway (Seconds)	Market Penetration				
	20%	40%	60%	80%	100%
1.25	*	*	*	7.85 (41.07%)	9.24 (48.35%)
1	*	*	8.17 (42.75%)	9.74 (50.96%)	11.30 (59.13%)
0.75	*	8.79 (45.99%)	10.08 (52.74%)	10.66 (55.78%)	12.66 (66.24%)
0.5	7.69 (40.24%)	9.75 (51.02%)	10.92 (57.14%)	12.09 (63.26%)	13.26 (69.38%)

\* not statistically significant

**Figure 2.3. Percent Travel Time Savings by Headways and Market Penetration Rates (15).**

An Auburn University research team studied potential traffic flow and mobility impacts under various scenarios. They performed truck traffic modeling during peak hours on a 5.3-mi segment of a rural freeway, including modeling on one of the interchanges on the segment, and modeling on a segment without interchanges. Various parameters were used for the sensitivity analysis of the simulations, including market penetration rate, headways, and traffic volumes (6). The research team found that driver-assistive truck platooning could save from 40 percent (with 20 percent market penetration and 0.5-second headway) to 69 percent (with 100 percent market penetration and 0.5-second headway) travel time during peak hours on the 5.3-mi section of I-85 (see Figure 2.3) (15).

In addition to the travel time savings of a two-truck platoon, three-truck platoons are estimated to double the potential throughput of trucks in dense traffic conditions (14, 16). It can be concluded, theoretically, that as the number of vehicles in a platoon increase and the following distances decrease, the overall throughput of a roadway will increase (9). However, multiple truck platooning might adversely impact traffic flows of urban highways with shorter on- and off-ramp spacing and high weaving, merging, and diverging movements.

It is difficult to anticipate such trends with certainty because capacity also depends on the adopted safety level (i.e., headway requirements) (13). Also, the truck operation cost is expected to decrease by the adoption of the Society of Automotive Engineers (SAE) Level 3 and higher technologies due to better fuel economy and decreasing labor and safety-related costs. This trend conversely may induce higher truck freight demand for transported goods over local goods and modal shift to the truck (13).

### **Labor Impacts**

Hours-of-service (HOS) regulations may need to be changed to allow drivers to operate the vehicle longer, assuming that productivity and non-driving hours increase with the adoption of connected and automated truck technologies (13). The American Transportation Research

Institute (ATRI) performed its annual survey of motor carrier executives and commercial drivers to examine the trucking industry's issues, and HOS ranked at the top of the list. The details are summarized below (17).

Because current rules were developed based on SAE Level 2 or on less-configured vehicles that require the full attention of the driver, the HOS rule for that level does not need to be changed. In addition, Level 3 automation needs a driver's attention to remain alert and take control of the truck in case of emergency, which does not necessarily require HOS rule modification. Under Level 4, or full automation, where a vehicle can be controlled by the automated system for several hours or fully on specific roadways or interstate highways (IH) without any intervention from the driver, the driver can rest or sleep in the sleeper berth without stopping the truck. Thus, current HOS regulation might require more flexibility to adopt to a higher vehicle technology level (17).

A vehicle with Level 5 technology, along with adequate infrastructure, will not be publicly available soon, although it could be a solution to the driver shortage issue. As SAE Level 3 and 4 trucks become commercially available, truck driving might become more attractive because the advanced vehicle technologies enable drivers to relieve driving stress and work on other tasks or rest while the vehicle is moving by itself. Carriers can potentially attract drivers by utilizing newer model equipment with autonomous truck technologies to ensure safety and to reduce long hours of driving, which has a positive impact on the job market and eventually drivers' health and wellness (17).

A report from the University of California (UC)-Berkeley Labor Center and Working Partnerships USA noted that without policy intervention, automated trucks that are best suited for long-distance highway driving might eliminate high- and mid-wage trucking jobs while creating low-quality driving jobs. The report analyzed impacts in detail by type of truck driving jobs under various adoption scenarios and concluded that around 294,000 drivers who mainly drive long distances with few specialized tasks will likely be impacted by automated trucks. However, more local driving and last-mile delivery jobs will be created, but without proactive public policy intervention, such jobs may have poor working conditions and lower wages (18).

Although some speculate that automated trucks will eliminate the need for truck drivers, required freight movement tasks besides driving tasks are still required from truck drivers, such as shipper/client relationship management, equipment management, route management, cargo management, and regulations (17).

### **Driver Training and Commercial Driver's License Impacts**

Importantly, to adopt automated trucks and truck platooning technologies, drivers should learn and become acquainted with the new system. Training for truck platooning systems has a significant shallow learning curve and does not require substantial training for drivers (19).

Driver training is important because drivers with more experience and higher familiarity with a driver assistance system tend to better adjust to the shorter following time gaps behind the leading truck (5). Industry stakeholders should expect to pursue in-service training, certification, and endorsements as part of truck driver education and training. Currently, the trucking industry trains their employees in new technology systems primarily through in-service training. However, the quality of training may vary by the size and resources of trucking firms, which makes it challenging to ensure that truck drivers maintain consistent standards of new technology across the country. Therefore, providing the automated truck and truck platooning technologies endorsement or making changes in commercial driver's license (CDL) requirements can help the standardization of truck drivers to develop their required skillsets to operate automated and connected trucks (20).

The U.S. Department of Transportation's (USDOT's) policy will no longer consider that the commercial motor vehicle (CMV) driver is always a human or that a human driver always needs to be present onboard to operate a vehicle. The Federal Motor Carrier Safety Administration (FMCSA) and each US state will consider the fundamental approach to set the federal qualifications required for CDLs to be applied for up-to-date vehicle technologies (21).

The report from the UC Berkeley Labor Center asserts that policymakers should create a trucking innovation and jobs council to develop good career pathways and training/job-matching programs and to create safety-net programs to support transitions within and without the industry. Policymakers should also establish strong labor standards to maintain high-quality trucking jobs even under the future automated and connected truck environment (18).

### **Infrastructure and Land Use Impacts**

Increased routing of trucks to platoon-friendly lanes (e.g., limited access, exclusive truck lanes) may amplify wear and tear on those lanes. Additionally, platooned trucks might potentially exceed bridge load capacities, which might shorten bridges' lifespan. Thus, inter-truck following distance may need to be increased accordingly to accommodate specific bridges based on their load capacities (14).

Dedicated freight facilities will be needed to operate automated trucks and truck platooning efficiently, especially on IH. Under high-speed conditions, mixed traffic of autonomous and platooned trucks and non-autonomous vehicles might be dangerous for passenger vehicles. Also, the possibility of CAV technologies moving trucks more onto local roads makes planners consider both passenger vehicles and heavy-duty trucks at smaller headways on roadways, which is more challenging. Therefore, truck dedicated lanes/roads need to be considered at two levels: (a) autonomous trucks and non-autonomous trucks, and (b) heavy vehicles and light vehicles (13). More analyses on the dedicated truck lanes are still required because adopting dedicated truck facilities under a low penetration rate during the early adoption period could worsen the entire traffic system.

The parking requirement and rest area demand for trucks may decrease with connected and automated truck applications due to less active driving from truck drivers. Also, the report from ATRI claimed that SAE Level 4 technology and the following HOS regulation changes might decrease the need for truck parking spaces. Moreover, fully automated vehicle technology could eventually necessitate even fewer stops than SAE Level 4 trucks with a significant modification of HOS regulation (17).

To better adopt the automated and connected vehicle technologies, the focus of infrastructure investments needs to shift from road widening to better lane markings, intelligent on-road and roadside infrastructure, improved geometric design, better surface quality of roads, and thicker pavements (13).

### **Safety Impacts**

Safety improvement is one of the significant benefits of connected vehicle technologies, especially when applied to heavy trucks. In 2017, 4,761 people were killed in large-truck-involved crashes out of 37,133 people who were killed in motor vehicle crashes on US roadways that year (1, 22), which means that fatalities from large-truck-involved crashes make up only 12.8 percent of entire fatalities of motor vehicle crashes. However, the fatality rate per 100 million vehicle miles traveled (VMT) is 1.16 and 1.60 for the entire motor vehicle traffic fatalities and the large truck-involved fatalities, respectively (1, 23). Seventy-two percent of people killed in large truck crashes were occupants of other vehicles, including passenger vehicles, light trucks, and motorcycles. Another 10 percent were pedestrians and pedalcyclists, and only 18 percent were occupants of large trucks (23). The significance of heavy-duty truck-related fatality crashes comes from the fact that they mostly involve other vehicles' occupants and non-motorists.

Thirty-two percent of large truck fatal crashes involved one or more driver-related factor; speeding was the leading factor, followed by distraction or inattention caused by using a cell phone, lost in thought, or eating (23). Four percent of the entire large truck fatal crashes in 2017 were related to driver impairment involving alcohol, fatigue, or illness; another 4 percent were related to careless driving (23). Automated trucks and truck platooning technologies suggest a potential reduction of 32 percent of truck-involved fatal crashes and will also mitigate the risks of other types of vehicles being involved in large truck crashes.

Adaptive cruise control (ACC) and collision mitigation systems will enable the truck driver to brake as quickly as possible to prevent collision with a cut-in vehicle and lane departure crashes (24). Conceptually, driver reaction time no longer needs to be considered if trucks are being controlled automatically, and automatic control will reduce potential rear-end collisions as well as the overall stopping distance of the platoon (13, 14). Reducing the frequency of cut-ins from other drivers by adopting ATs and truck platooning technologies will also benefit roadway safety and further relieve drivers' stress (25).

It is crucial to consider transitional adoption periods of automated and connected vehicle technologies of the trucking industry because safety for conventional trucks and passenger vehicles may be at risk. In addition, mechanical failure or software failure of automated and connected vehicles might result in more fatalities, especially when heavy vehicles are involved (13). Therefore, project cargos that transport windmill blades, bridge beams, or oversized equipment; oversize-overweight trucks; and trucks that carry hazardous materials require careful consideration or should be restricted while allowing the eligibility of full automation and platooning. Although automated trucks and truck platooning technology adoption have a significant potential to reduce the number of accidents and fatalities, additional testing is still needed to prove safety improvements under various circumstances.

### **Economic Impacts**

Trucks that generally travel along the same corridor at the same time with compatible equipment can be platooned together, which will lead to utilization savings for most of the large fleet operating companies. Moreover, if a higher level of automation technology applies, only a lead truck will require a driver, which significantly reduces labor costs (13).

Potential transitions to the trucking industry at the microeconomic level will be required when adopting automated trucks with SAE Level 4 and above. First, drivers' productivity might increase based on potential changes in HOS rules. Less human and vehicle resources will be needed to transport the same amount of freight, and drivers can be engaged in tasks other than driving while the vehicle is operating. Following the first transition, drivers' tasks, including administrative tasks and route management, might be expanded. Moreover, equipment costs may increase because of the advanced technology level. Last, insurance costs may decrease due to fewer crashes (17). Insurance and liability issues under the automated trucks and truck platooning environments are still debatable and under consideration, which will be discussed in more detail later in this paper.

Although the return on investment for truck platooning and automated trucks is still unclear, additional costs of adopting the technologies can be expected, including equipment acquisition, driver training, logistics and coordination, testing, and insurance costs. Driver assistance technologies' pricing over the last few years shows that an additional \$300 to \$10,800 will be added to the purchase price of a new vehicle (20, 26). The North American Council for Freight Efficiency presented a simple payback calculator in their two-truck platooning report. The calculator considers multiple inputs, including equipment costs, subscription costs, maintenance costs, insurance costs, and fuel savings (19). However, the operators' total cost of ownership will decrease as trucks become fully automated. (27).

## **Intermodal Freight Operation**

Automated truck concepts are possible solutions for platooning in drayage operations and driverless container transfer at intermodal terminals. Moreover, it is expected to offer significant improvements to logistics by enhancing throughput and reducing traffic congestion in and near ports, which will eventually lead to emission reduction (13). The Maritime Administration and FMCSA are performing a joint study to explore how SAE Level 4 truck automation can impact intermodal port operations. The objective is to measure the productivity of adopting full or partial automation of queuing within ports, which will alter the responsibilities and physical presence of drivers and potentially allow them to be off-duty during the loading and unloading process (21).

## **POTENTIAL IMPEDIMENTS OF AUTOMATED TRUCKS AND TRUCK PLATOONING**

As discussed in the previous section, adopting automated trucks and truck platooning technologies will benefit various aspects of the current transportation system. However, some issues need to be measured thoroughly before implementing a higher level of vehicle technologies with a bigger level of market penetration rate. Four major issues that have been discussed extensively in the field are described in this section.

### **Cybersecurity Issues**

In recent years, multiple studies have proven that it is possible to remotely access an automated car's system by exploiting a bug in a vehicle's software and take control of the system, which results in engine shutdown and wrongful detection of obstacles (17). Attackers could be more motivated to access trucks than passenger vehicles because trucks tend to move commodities with high values and hazardous cargos. In addition, CMVs generally have a longer life span than light vehicles, which makes older trucks easy to attack (13).

Vehicles with a higher level of automation are more vulnerable to cybersecurity attacks since drivers' engagement is minimized, and it is difficult for the automated system to disengage and hand over the driving tasks to the drivers within a certain time to avoid the threats (28). Combining data from different sensors, communication systems, and software is also one of the challenges for automated and connected vehicles. When inputs from various sources are fused, it is crucial to identify an anomalous input that might be produced by attackers (29, 30).

Under the automated and connected vehicle environment, every part of the system is a target, including infrastructure signs, global positioning systems (GPSs), in-vehicle devices, radar, Light Detection and Ranging (LiDAR) technology, in-vehicle sensors, and odometrical sensors. For example, fake messages from an adjacent vehicle or attacked infrastructure roadside unit (RSU) can jeopardize not only the vehicle itself but all the vehicles engaged in the same platoon. In



other cases, attackers might perform global navigation satellite systems' spoofing to provide false locations to the vehicle automation system (30).

Government and industry are making efforts to alleviate vulnerabilities and threats by introducing the Security Credentials Management Systems and developing new standards (SAE J3101, SAE J3061 Cybersecurity Guidebook for Cyber-Physical Vehicle Systems, etc.) (13).

### **Privacy Issues**

With the rapid growth of automated and connected vehicle technologies, privacy concerns have been raised, especially related to data sharing. Fagnant and Kockelman (31) proposed five data-related questions: Who should own or control the vehicle's data? What types of data will be stored? With whom will these data sets be shared? In what ways will such data be made available? For what ends will they be used?

Automated and connected trucks are comprised of multiple technologies and sensors that emit and take in a large amount of data. Congress expressed concerns regarding the commercial uses of dedicated short-range communications (DSRC), saying that it could make vehicles vulnerable to security and privacy threats by exposing location data (13). The truck industry sector has raised privacy issues related to electronic inspection technologies. Especially, the industry argues that an electronic logging device (ELD) could violate the truckers' privacy. With potential changes to HOS regulations, a vehicle with SAE Level 5 will not need an ELD, but a customized ELD will likely be required for truck drivers operating SAE Level 3 and 4 trucks (17). By using advanced vehicle automation technologies, highly accurate mapping data can be stored and be sent to a central data hub. However, outside entities, like competitors or government regulators, might access such data to use against the private trucking industry. Therefore, documenting how any types of vehicle communication systems and GPS tracking devices will safeguard privacy will be crucial to achieve successful deployment of connected and automated trucks (13). It is also important to develop a framework for managing and processing a huge flow of data to be efficiently used for transportation planning purposes.

### **Liability**

Autonomous vehicles can decrease the costs of truck crashes for the entire transportation system by reducing driver's at-fault crashes. On the other hand, overall liability for trucking companies may increase due to lawsuits. Some vehicle manufacturers are reluctant to produce SAE Level 4 autonomous vehicles and argue that they need "some kind of law pre-empting state liability." Several states passed laws to limit the liability of the original manufacturers of a vehicle on which a third party has installed an automated system (13). In the event of an accident, the automated motor vehicle system itself or any human operator of the automated vehicle shall follow the same procedure as other vehicles. For example, Texas law requires the automated

motor vehicle to be covered by motor vehicle liability coverage or self-insurance in an amount equal to coverage of conventional motor vehicles (32).

Primarily, the inconsistency between state laws is a potential implementation problem with respect to liability, and such inconsistency leads to a potential inequitable treatment, which discourages trucking companies from engaging in platooning (33).

## **Regulatory**

The US Congress developed bills in late 2017 related to ensuring a safe environment for highly automated vehicle testing and deployment. The “Safely Ensuring Lives Future Deployment and Research in Vehicle Evolution Act,” also known as the SELF DRIVE Act (H.R. 3388), strictly defines highly automated vehicles and partially automated vehicles without a CMV (34). The “American Vision for Safer Transportation through the Advancement of Revolutionary Technologies (AV START) Act” (S.1885) only applies to vehicles with a gross weight of 10,000 pounds or less (35).

The federal agencies that have responsibilities over regulations and standards for truck automation and platooning technologies on US highways include FMCSA, Federal Motor Vehicle Safety Standards, the National Highway Traffic Safety Administration, and the Federal Highway Administration (FHWA). The CMVs in the United States must abide by the Federal Motor Carrier Safety Regulations (FMCSRs), which does not address commercial vehicles that are partially or completely operated by the automated driving system. The Volpe National Transportation Systems Center (Volpe) conducted a comprehensive review of the FMCSRs for different levels of automated commercial vehicles. Although some of the issues under near-term driver assistance features can be cleared through current regulatory interpretations, regulations covering a highly automated driving system that requires a minimum level of or no human driver involvement is significantly challenging. A detailed review of the current regulations under different levels of automated commercial vehicle technologies can be found in Perlman et al. (36).

In recent years, several states have started authorizing pilot studies of truck platooning or exempting CMVs equipped with automated braking systems from their following distance rules: Louisiana (HB 308), Florida (HP 7061), Arkansas (HB 1754), and Alabama (SB 125) (37–40). However, one of the main concerns lies in the inconsistent state laws since it could impact interstate commerce and, further, intercity commerce in states that hold “home rule sovereign.” Federal legislation is expected to provide consistency between states to ensure smoother operations between states and local jurisdictions (41).

## **IDENTIFICATION OF TRENDS IN AUTOMATED TRUCKS AND TRUCK PLATOONING VEHICLE TECHNOLOGIES**

This section provides an overview of automated trucks and truck platooning technologies and the status quo of the technologies by using the information obtained through a literature review. Due to the emergence of recent technologies, selected new articles are also reviewed. The research team reviewed and summarized the base list of technologies that are required to deploy automated trucks and truck platooning successfully. In addition, the researchers addressed some new approaches that are recently being discussed in the area.

### **Base List of Technologies Required for Automated Trucks and Truck Platooning Deployment**

Conventionally, there are three types of technologies to enable automated and connected truck deployment: sensors, communications, and software. Vehicle technology sensors include cameras, radar, LiDAR, and GPS. Those components are largely used to identify objects, vehicle speed, and vehicle position while driving (26).

However, cameras and LiDAR sensors experience challenges in adverse weather conditions. Radar, on the other hand, is cheaper and works better under poor weather conditions but cannot replace LiDAR's ability to scan and detect 3D objects. LiDAR can emit infrared light to overcome the limitations of poor visibility under low-light conditions. Unfortunately, it still has limitations in that the data may be skewed by overexposure from reflective surfaces (i.e., road signs), and it cannot operate in a narrow light band, which prohibits the sensor from detecting color and contrast (i.e., lane markings, traffic lights, and characters on traffic signs) (42). Moreover, based on Volvo's mining truck prototype tests, dirt and other contamination materials often cover LiDAR lenses. Although they have developed a solution for cleaning LiDAR surfaces, more research needs to be done to ensure all the sensors are fully functioning in any conditions (43). These limitations lead to the discussion of a LiDAR-free approach or a solid-state LiDAR approach that are indicated in detail in the next section.

Communication technologies like DSRC and fifth generation (5G) mobile communication systems enable trucks to communicate with each other and infrastructure. Currently, DSRC dominates vehicle-to-vehicle (V2V) and vehicle-to-infrastructure (V2I) communications in 5.9 GHz band, allowing vehicles and infrastructure to send messages and provide alerts to drivers in real time. An application of 5G to truck platooning has been proposed in recent years and is still under development. 5G technology is expected to provide highly reliable and low-latency communications to truck platooning (44).

Last, software systems with various algorithms and artificial intelligence technologies are used to process images, interpret messages from other vehicles or infrastructure, and control vehicles in real time (25).

## **New Approaches to Automated Trucks and Truck Platooning Technologies**

### *LiDAR-Free Approach and Solid-State LiDAR*

LiDAR emits electromagnetic radiation and detects the return wave reflected from solid surfaces. It measures the range and speed of objects based on the time it takes for the laser light to reflect. A motor-driven scanning LiDAR has been used for 3D digital mapping and assessing the environment in real time. However, the widely known limitations of LiDAR are the high cost, complexity, and low durability of the hardware. In addition, the sensor tends to be blinded by direct sunlight (42).

To avoid such drawbacks, discussions have been had regarding automated truck deployment without using LiDAR. Starsky Robotics, a company that specializes in autonomous trucks, and a startup company, TuSimple, that develops artificial intelligence (AI) technology for autonomous trucking, have claimed that they are not going to use LiDAR technology. The reason the LiDAR-free approach has been proposed is because of the sensor's limitations in detection range and reliability. Unlike passenger vehicles, fully loaded trucks driving 60–65 mph on highways require longer braking distance; however, the current long-range LiDAR cannot detect objects in full detail at such speeds. Also, it is not durable enough to be used over the lifetime of trucks. Material reflectance affects LiDAR's perception quality too (45, 46).

Cameras are relatively cheaper than other types of sensors and highly customizable. For additional reliability, an automotive-grade radar can be used to detect the existence of potential objects and measure their velocity. Radar is not effective at identifying precise locations and tends to create many false positives; thus, cameras can serve as a supplement (46). Therefore, instead of LiDAR, Starsky Robotics installed seven different automotive-grade cameras and an automotive-grade radar to their prototype trucks. TuSimple implemented an array of four to five cameras precisely retrofitted to a Peterbilt truck and a radar for backup in severe weather. In Starsky Robotics' case, such vehicle configuration seems viable because they use human teleoperators to drive certain miles on and off the highway and supervise the system to detect strange obstacles ahead (43, 45, 46).

To provide cost-effective automotive-grade LiDAR, many developers are seeking ways to develop inexpensive LiDAR sensors while maintaining its superior 3D imaging ability. As a solution to the cost issue, LiDAR suppliers such as Quanergy, Valeo, and Velodyne have begun to produce the sensors in high volumes so that the price can go down enough for truck manufacturers (43).

Among the various types of LiDARs, such as flash LiDAR, micro-electromechanical system (MEMS)-based LiDAR, optical phase array LiDAR, and solid-state LiDAR, solid-state LiDAR, which lacks the moving parts of the conventional LiDAR sensor, has been actively studied because of its affordable cost and satisfying long-distance scanning and hardware durability (42,

47). Solid-state LiDAR can improve sensor reliability by sweeping 360-degree views around trucks for blind-spot detection and automatic braking. A solid-state LiDAR shows a mean time between failures of more than 100,000 hours, which is 50 times better than a conventional LiDAR in terms of reliability (43).

### *5G for V2X Communications*

Vehicle-to-everything (V2X) safety applications—including cooperative sensing and maneuvering, high-density platooning, and teleoperated driving—require nearly 100 percent reliability, below 10 ms latency, and high data rate (in gigabits per second) communication technologies (48). Multiple associations and projects formed across stakeholders are developing and testing 5G architecture in connected and automated driving, such as 5G Automotive Association, Multi-access Edge Computing View project, Car2MEC project, European Automotive Telecom Alliance (EATA), 5GCAR project, and 5G NetMobil project (49). Those projects include network operators and suppliers, automotive original equipment manufacturers (OEMs) and suppliers, and academic organizations. The common objectives are providing safe and efficient automated driving environment by developing a reliable communication architecture with the 5G mobile radio networks.

The Japanese tech company SoftBank trial-tested 5G ultra-reliable and low-latency communication on truck platooning to confirm the advanced communication performance of 5G technology. According to its test, 5G will be highly beneficial in communication between platooned vehicles, which require low-volume, low-latency communication for controlling the vehicles and video monitoring and operating the entire platoon remotely, which requires high-volume, low-latency communication (44).

### *Automated and Connected Trucks Configuration*

A research team from Illinois Center for Transportation is developing a framework, Optimization of Lateral Position of Autonomous Trucks (OPLAT), of the lateral configuration of automated and connected trucks (ACTs) in a platoon. The objectives of this study are to decelerate the damage accumulation in pavement structures and to save money. It is reported that by implementing the framework, the total cost—that includes user costs and maintenance and rehabilitation costs—could be reduced by \$0.5 million per mile on average over 45 years, assuming 100 percent penetration rate (50). Under the current scenario of truck platooning, multiple trucks drive together in a convoy to benefit from fuel consumption efficiency and emission reduction. However, such successive truck platooning operations without different lateral positioning could deteriorate the damage accumulation of pavement structures.

The research team developed a flexible pavement design framework that considers the lateral position of loading, axle width, and lane width. In addition, the team performed truck aerodynamics modeling and simulated using in-house finite element models. The developed

model measures the level of fuel efficiency concerning lateral offsets of trucks in the platoon and their distance gap. Although lateral shifting of less than foot does not affect the air drag reduction, lateral shifting up to 6 to 8 ft does not show effective aerodynamic drag reduction (50). Therefore, the lane-changing model still needs to be studied, and the research team is going to conduct field experiments to validate the simulated results.

Chen et al. (51) noted that uphill conditions, downhill conditions, and mountainous terrain should be considered in designing truck platooning. In the real world, each platooned truck's characteristics may vary widely. Therefore, to design optimal control for any terrain conditions, it is important to consider vehicle heterogeneity in a vehicle control framework.

In addition, during in-vehicle real-time planning, many trucks could be directed to the same links, which will deteriorate roadway structure and pavement and create congestion. Thus, routing trucks by using several other links can benefit the entire transportation system (11, 13). It is also important to maximize the participating number of companies during the initial phase of truck platooning and automated truck implementation to maintain system sustainability. An incentive scheme from the government might encourage industry participation (11).

## **CHAPTER 3. ONLINE SURVEY AND TELEPHONE INTERVIEWS**

### **INTRODUCTION**

The online survey that was a part of Task 2 was conducted on various types of stakeholders in automated and platooning trucking areas, including trucking fleet personnel, federal administrators, state departments of transportation personnel, local MPOs, automated and connected vehicle manufacturers, and platooning system suppliers. Survey questions focused on the respondent's opinions on the future implementation of truck platooning and automation in terms of planning and policy aspects. The survey also asked about truck platooning configuration aspects for the deployment of automated and platooning truck technologies in the Texas highway system.

At the beginning of the survey, respondents were asked to provide demographic information, such as identifying their role in relation to truck platooning and automated trucks. If a respondent was part of trucking fleet personnel or in the fleet management industry, additional questions were asked to identify the type of trucking industry sector, the typical length of haul, and the types of roadway most commonly used. The collected demographic information was expected to provide a better understanding of the respondent's perspective on automated and platooned truck technologies. Survey questions were designed to collect respondents' perception of and familiarity with automated truck and truck platooning technologies, along with their views on the implications of the technologies in terms of planning, policy, vehicle and testing configurations, infrastructure, and economy.

The survey questionnaire is attached in Appendix A.

### **SURVEY ANALYSIS**

The online survey through SurveyMonkey was active for about four months and included approximately 30 questions per each stakeholder type. There were three groups of stakeholders categorized for this survey: (1) trucking fleet personnel, owner-operators, and industry associations; (2) OEMs, startups, Tier 1 and 2 suppliers, system integrators, and other implementers; and (3) legislative, government, Texas cities/MPOs, and state DOT personnel.

The first online survey link was initially sent to 43 people, and 16 responses were received. The second online survey link was sent to 60 people, and the team collected another 16 responses. After removing blank responses, 24 valid responses were included in the analysis. Of the 24 responses, three were from fleet management, two were from automated and connected vehicle manufacturers, 10 were from state DOT personnel, and seven were from local MPOs. Two responses were reported as "other" stakeholder types. These responses were categorized based on the reported affiliations that are Type 1 stakeholders for both responses. Table 3.1 lists the number of respondents by type of stakeholder.

**Table 3.1. Number of Survey Respondents by Stakeholder Type.**

<b>Stakeholder</b>	<b>Number of responses</b>	<b>Percentage</b>
Type 1	5	21%
Type 2	2	8%
Type 3	17	71%
Total	24	100%

**Type 1 Stakeholders—Trucking Fleet Personnel, Owner-Operators, and Industry Associations**

*Demographics*

Among those stakeholders categorized as Type 1, three were employed with fleet management, and two reported “other.” The Type 1 stakeholder respondents were engaged in various sectors of the trucking industry, including truckload, less-than-truckload, and tanker. Their typical length of haul varied from local (less than 100 mi) to long haul (1,000 mi or more per trip). The frequently driven types of roadways were distributed evenly among urban interstate and similar class highways, rural interstate and similar class highways, undivided rural highways, and urban and suburban roads and streets.

*Survey Responders’ Perceptions of Automated and Connected Truck Technologies*

When survey participants were asked about their familiarity with the use of truck ACC, one reported *not at all familiar*, one *slightly familiar*, two *very familiar*, and one *extremely familiar*.

Survey participants were asked the maximum amount per truck that they are willing to pay to purchase the equipment required to allow platooning and automated truck operations. Two participants reported between \$1,000 and \$5,000, and one reported less than \$1,000.

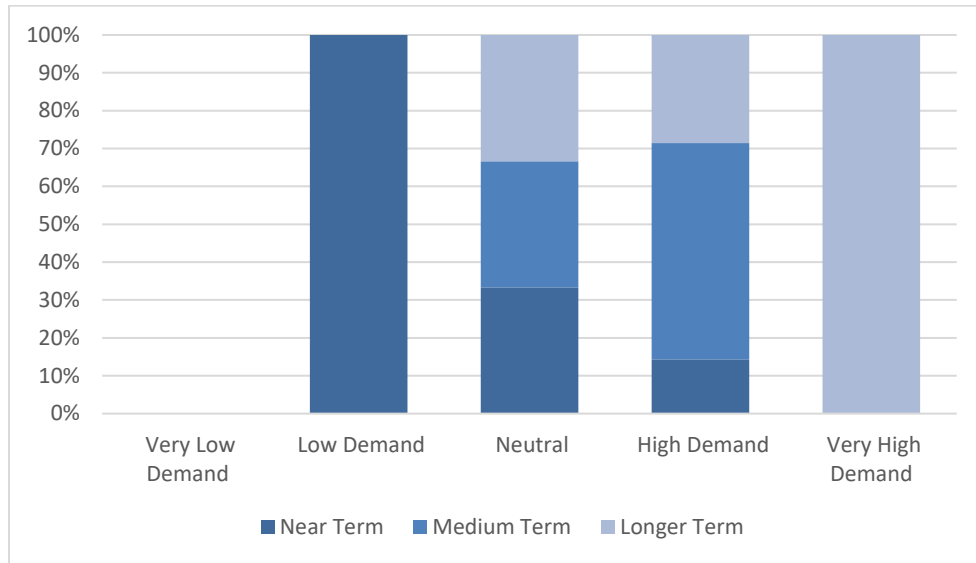
Participants were asked with whom they should be able to platoon when operating in the vicinity of other platoon-capable trucks. A majority reported that they should platoon with specific fleets they are already agreed to partner with (n = 4), followed by their own fleet trucks (n = 2). The Type 1 stakeholders were then asked about requirements for drivers after initial training in platoon operations. All respondents agreed that periodic recertification should be required, and one response indicated that additional endorsement on a driver’s CDL should be expected.

Four participants reported it was *somewhat likely* and one participant reported it was *not very likely* that truck platooning will have a positive impact on driver retention. Participants were then asked how likely drivers are to want to use the automated truck system and truck platooning. For both an automated truck system and truck platooning, two reported *not very likely*, two reported *somewhat likely*, and one reported *very likely*.

Of the people surveyed, approximately 80 percent viewed the projected market demand for automated trucks and truck platooning technology will be high in the medium and longer term,



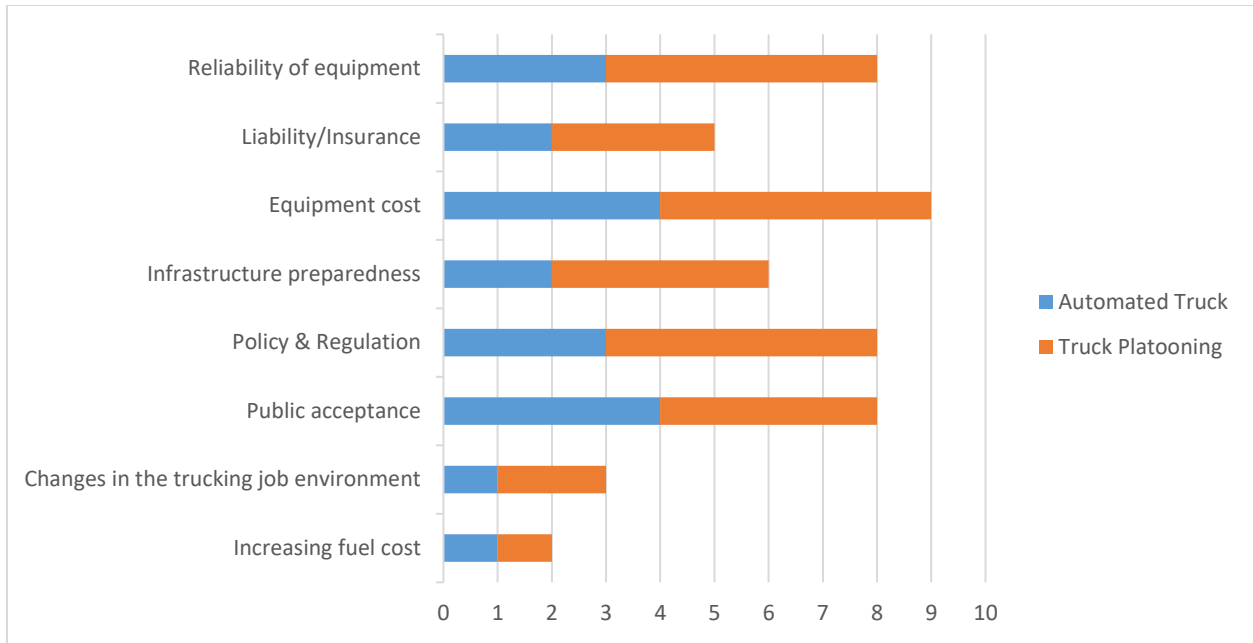
which is beyond 2026. Figure 3.1 shows the survey response indicating that the market demand for advanced vehicle technologies will get higher as time goes by.



**Figure 3.1. Projected Market Demand in Different Time Frame.**

*Planning and Policy Implications of Automated Trucks and Connected Truck Technologies*

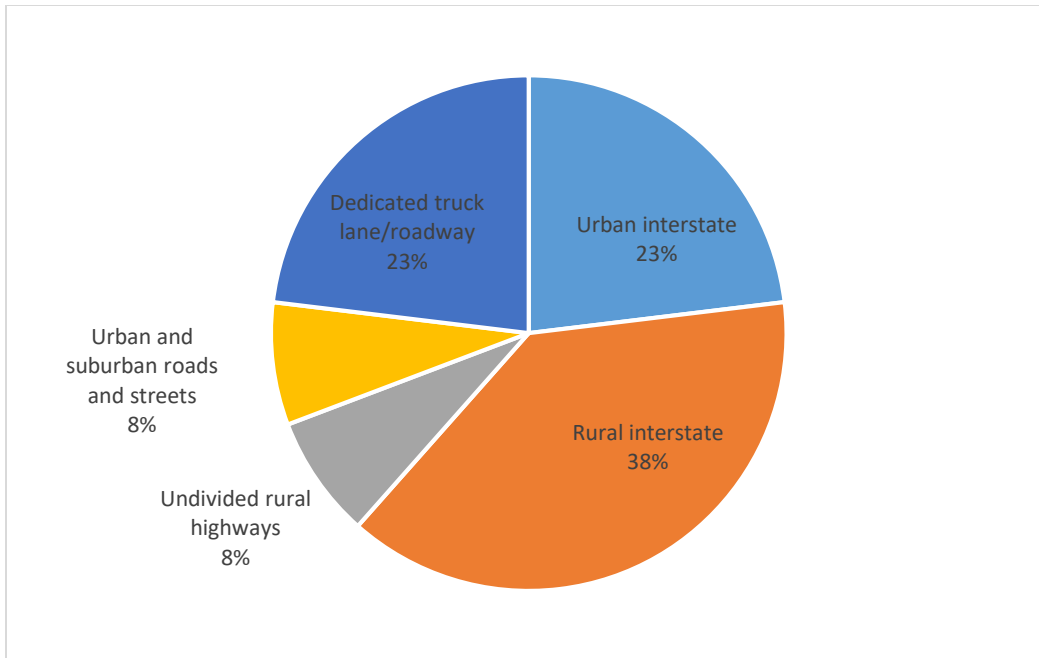
Figure 3.2 summarizes the challenges facing the transportation community based on the survey results. For important challenges facing the transportation community regarding the introduction of automated truck operations, Type 1 respondents ranked public acceptance and equipment cost as the two most challenging issues. Policy and regulation and reliability of equipment were listed next. Participants reported equipment cost, policy and regulation, and reliability of equipment as the top challenging issues to introducing truck platooning, followed by public acceptance and infrastructure preparedness.



**Figure 3.2. Challenges Related to the Introduction of Automated Truck and Truck Platooning.**

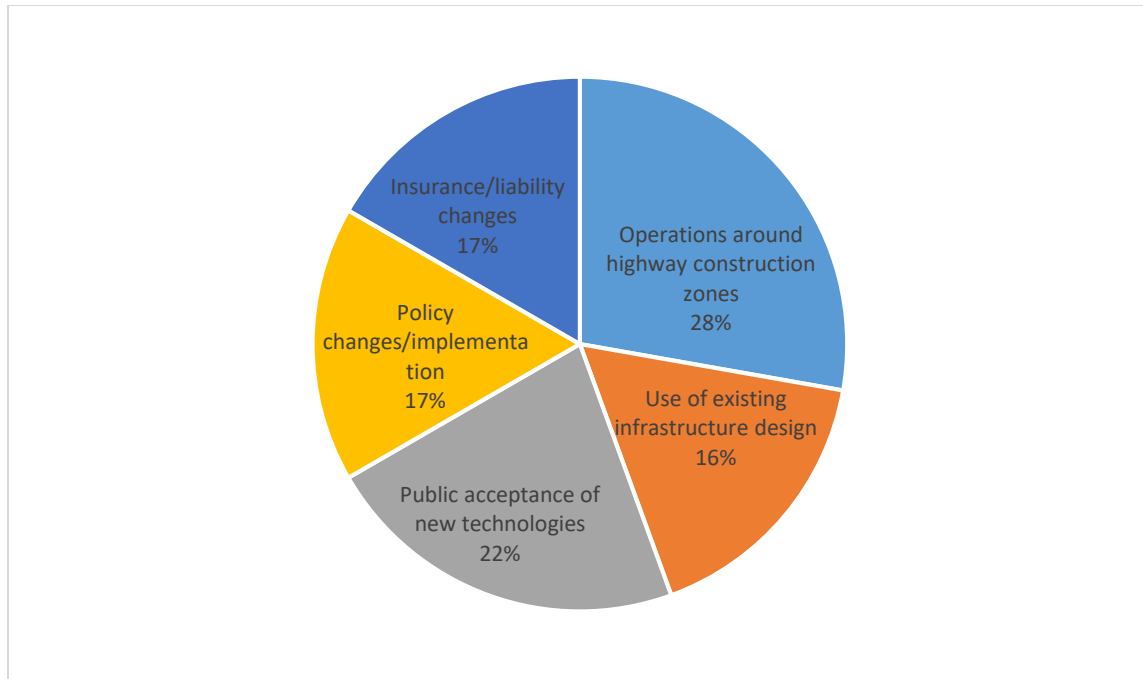
Figure 3.3 shows the survey response on the type of roads that should be considered for truck platooning. Type 1 stakeholders considered rural interstate with two lanes in the same direction to be the most suitable type of road for truck platooning operation, followed by urban interstate and dedicated truck land/roadway.

All the respondents agreed that a five-axle tractor-semitrailer, which is a typical 18-wheeler, should be allowed to engage in platooning.



**Figure 3.3. Types of Platooning—Allowable Roads.**

Figure 3.4 shows the survey responses regarding the most challenging potential complications and risk areas with platooning. Within the mixed environment of conventional trucks, passenger cars, automated trucks, and platooned trucks, Type 1 stakeholder respondents considered operations around highway construction zones the most significant complication. Public acceptance of new technologies were other major complications that the trucking industry expected during the transition period, followed by the use of existing infrastructure design, policy changes/implementation, and insurance/liability changes.



**Figure 3.4. Complications and Risk Areas during the Transition Phase.**

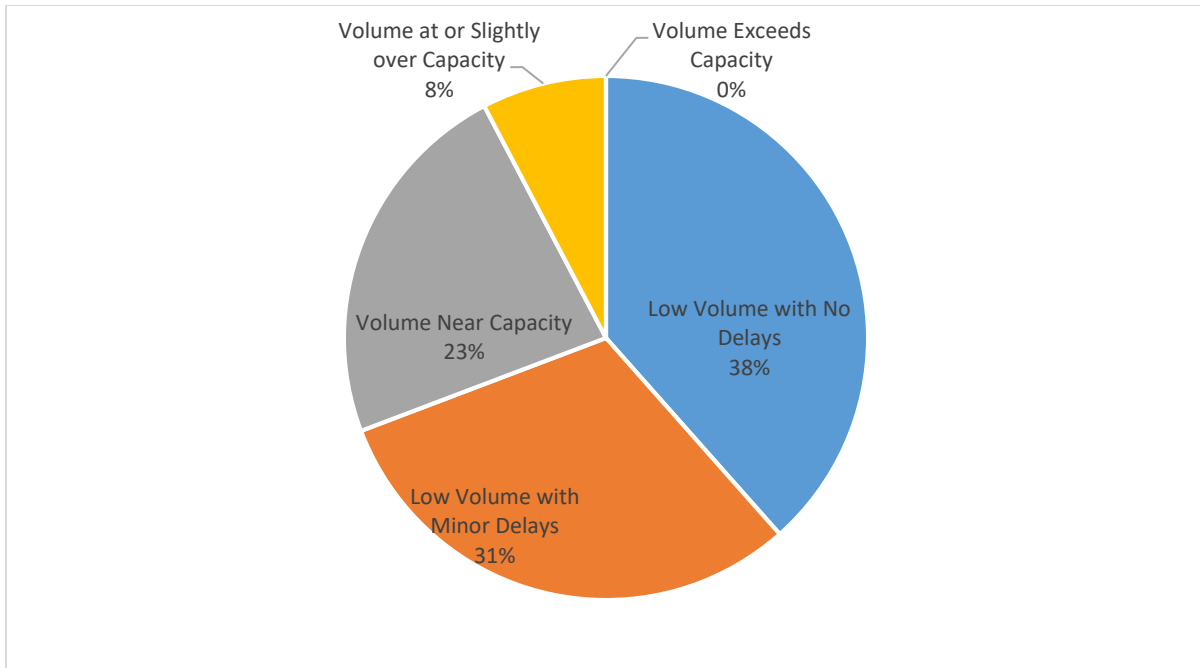
Survey participants were asked what level of involvement is expected in facilitating automated and platooned trucks from infrastructure owner-operators. Type 1 stakeholder respondents expected some level of participation from the infrastructure owner-operator. Four respondents expected owner-operators to be actively involved in setting up automated and platooned trucks, three expected them to be involved in allowing automated and platooned trucks, three expected them to be involved in approving requests for automated/platooned operations, and two expected them to be involved in sending notification to automated and platooned trucks.

#### *Technical and Infrastructure Implications of Automated Trucks and Truck Platooning*

Figure 3.5 summarizes the survey responses regarding which traffic volume conditions are suitable for permitting truck platooning. Four respondents reported that dynamic signals could be used as a communication tool between truck platooning and automated truck corridors/segments and highway users. Three reported that static signage could be used. The other comment suggested the use of digital transmission.

Under snowy and icy conditions, the majority of respondents recommended that truck platooning not be permitted due to the high risks; some respondents also felt it should not be allowed in wet and rainy conditions.

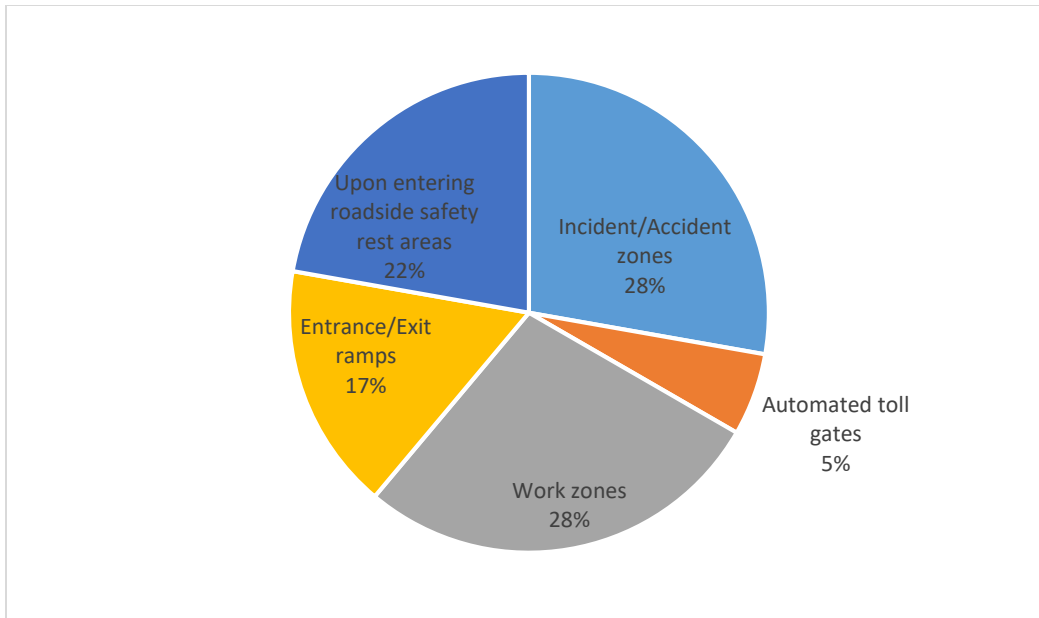
None of the respondents believed that truck platooning should be allowed when traffic volume exceeds roadway capacity. They highly recommended permitting truck platooning under low traffic volume conditions with no or minor delays.



**Figure 3.5. Traffic Volume Conditions to Permit Truck Platooning.**

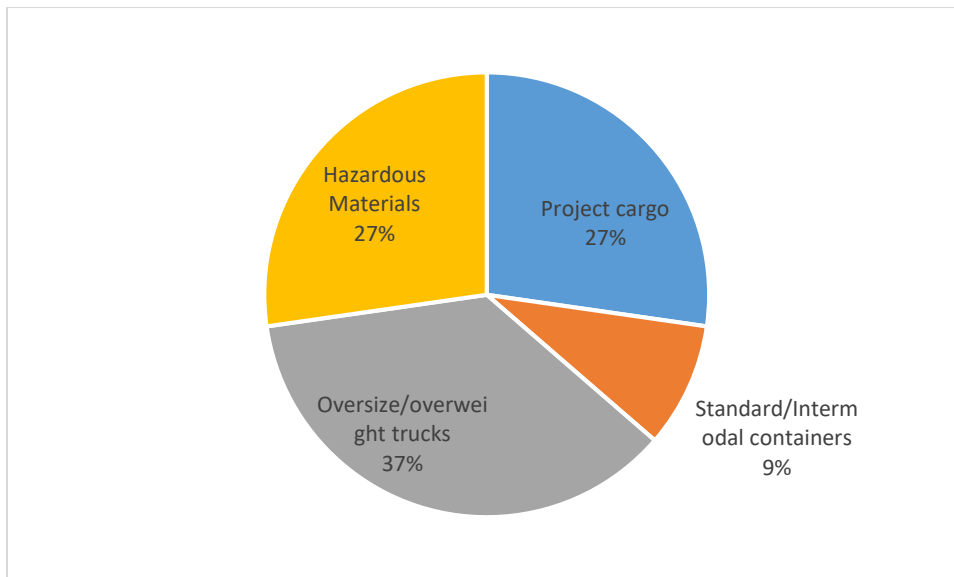
Some respondents felt infrastructure changes like interchange and ramp spacing (n = 4) and pavement markings (n = 4) will be necessary to implement automated and platooned truck technologies. Some respondents recommended signage movements (n = 3). Moreover, one of the respondents commented that truck-only lanes might be needed in the future automated and platooned truck environment.

Figure 3.6 shows a summary of the survey responses to which areas truck platooning needs to disengage when entering. Disengaging truck platooning was most recommended in incident/accident zones and work zones, followed by upon entering roadside safety rest areas and entrance/exit ramps.



**Figure 3.6. Areas Where Truck Platooning Needs to Disengage.**

Figure 3.7 shows the survey responses to which types of cargo truck platooning should not be allowed. The results showed that 27 percent of the respondents identified hazardous materials, with 37 percent identifying oversized/overweight trucks with 27 percent identifying other project cargo and 9 percent identifying standard/intermodal container traffic.



**Figure 3.7. Types of Cargo for Which Truck Platooning Should Not Be Allowed.**

## **Type 2 Stakeholders—OEMs, Startups, Tier 1 and 2 Suppliers, System Integrators, and Other Implementers**

### *Demographics*

Two respondents who are employed with automated and connected vehicle manufacturers participated in the survey and were categorized as Type 2 stakeholders. Due to the small number of participants, the summary of their responses will be shown in the following sections instead of reporting each of the responses in detail.

### *Survey Responders' Perceptions of Automated and Connected Truck Technologies*

Participants reported that market demand would increase as time goes beyond the medium term, which means beyond 2026. The respondents were then asked to select the most important challenges that the transportation community faces with the adoption of automated vehicle technology. They both agreed that public acceptance, policy and regulation, and liability/insurance are the crucial issues to be addressed in regard to the adoption of advanced vehicle automation technology.

### *Planning and Policy Implications of Automated Trucks and Connected Truck Technologies*

The respondents reported that urban interstate and similar class highways and dedicated truck lanes/roadways can be allowed for platooning. Multi-trailer and five-axle tractor-semitrailers were reported as types of vehicles that should be allowed to engage in platooning.

Type 2 stakeholder respondents expected to see Level 2, 3, and 4 vehicle automation soon—between 2020 and 2025. They expected that Level 5 automation, where an automated system can handle all roadway conditions and environments, could be seen after 2026.

Within the mixed environment of conventional trucks, automated trucks, and platooned trucks, the most significant complication/risk area that they envisioned was the public acceptance of new technologies.

When the participants were asked how truck platooning and automated truck corridors/segments should be communicated to highway users, the dynamic signal display was selected. The respondents felt that traffic volume conditions like low volume with no or minor delays and volume near capacity can allow truck platooning. They commented that although most automated commercial motor vehicles are being designed for the existing infrastructure, improved pavement markings would be helpful in the automated and platooned truck environment.

The respondents reported that trucks transporting hazardous materials should be restricted from platooning. Work zones, entrance/exit ramps, and entering roadside safety rest areas were selected as areas where truck platooning should be disengaged.

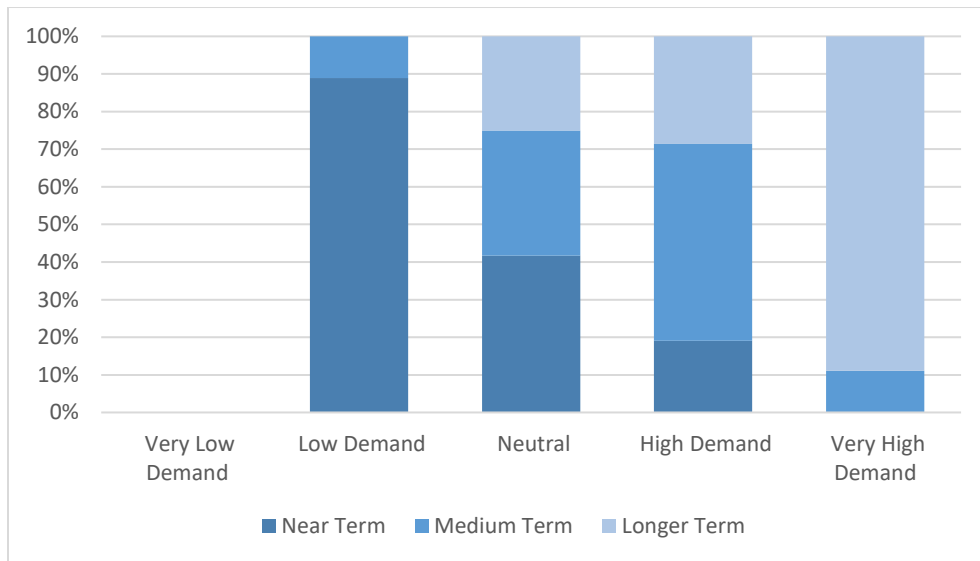
## Type 3 Stakeholders—Legislative, Government, Texas Cities/MPO, and State DOT Personnel

### *Demographics*

Among those who were categorized as Type 3 stakeholders, 60 percent were state DOT personnel, and 40 percent were employed with local MPOs. Of the Type 3 stakeholder respondents, 35 percent were engaged in planning, 34 percent were in infrastructure, 28 percent were in policy (28 percent), and 3 percent were in research.

### *Survey Responders' Perceptions of Automated and Connected Truck Technologies*

Figure 3.8 shows the projected market demand for different time frames from the survey. Of the people surveyed, approximately 90 percent viewed the projected market demand for automated trucks and truck platooning technology as very high in the longer term, which is beyond 2035. They expected somewhat moderate to high demand for those technologies between now and then.

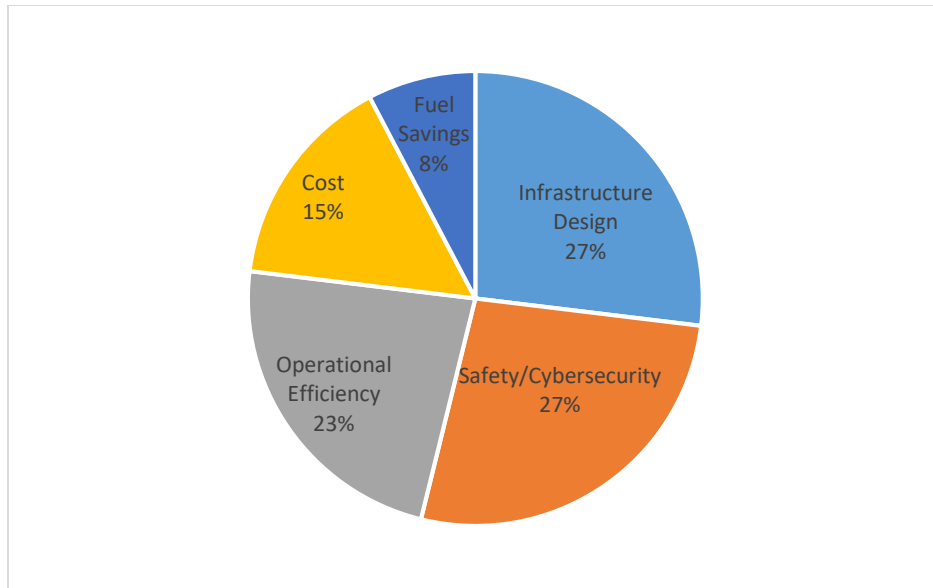


**Figure 3.8. Projected Market Demand for Different Time Frames.**

### *Planning and Policy Implications of Automated Trucks and Connected Truck Technologies*

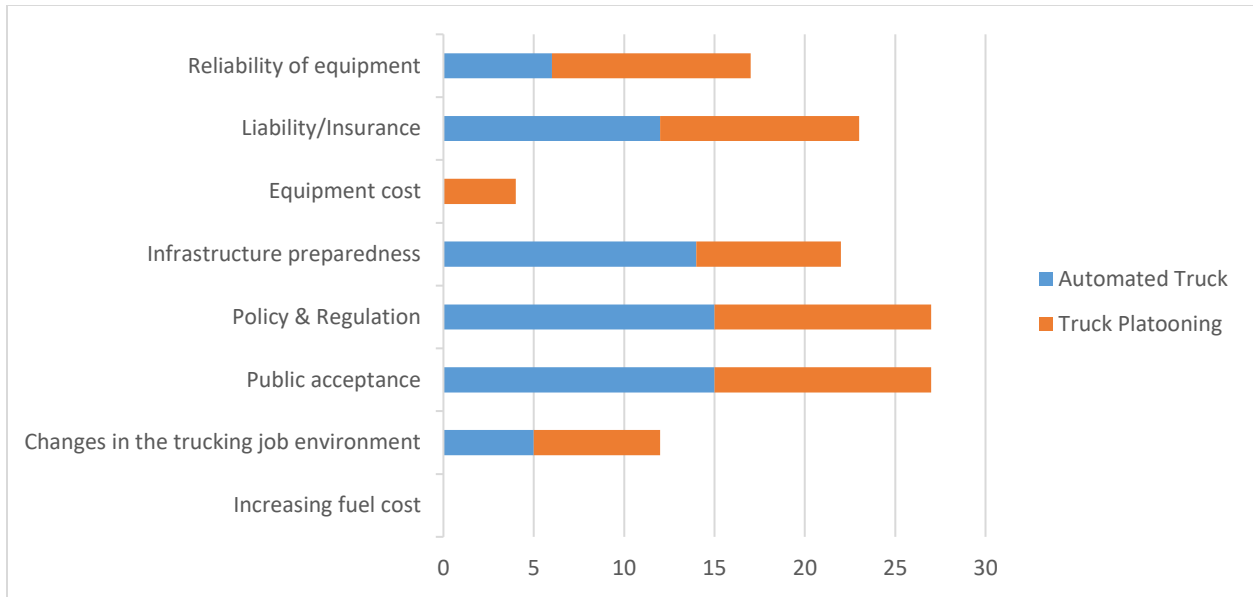
Figure 3.9 shows that the most significant planning factors considered essential for future DOT planning for truck platooning and automated trucks were safety/cybersecurity and infrastructure design, followed by operational efficiency, cost, and fuel savings.





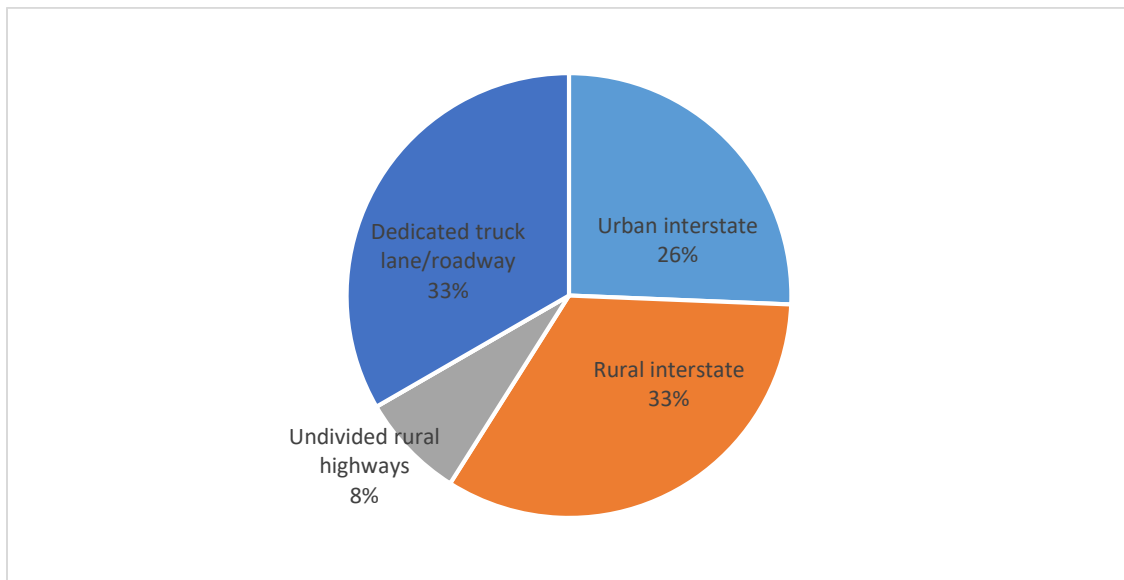
**Figure 3.9. Important Factors in Future DOT Planning for Platooning and Automated Trucks.**

Figure 3.10 shows the survey responses for the most important challenges facing the transportation community regarding the introduction of automated truck operations and truck platooning, respondents ranked (a) policy and regulation and (b) public acceptance as the two most challenging issues for both truck automation and truck platooning. Liability/insurance was in second place, followed by infrastructure preparedness, reliability of equipment, and changes in the trucking job environment, and equipment cost. None of the Type 3 respondents anticipated that increasing fuel cost would be an issue in the early adoption of automated trucks and truck platooning technologies.



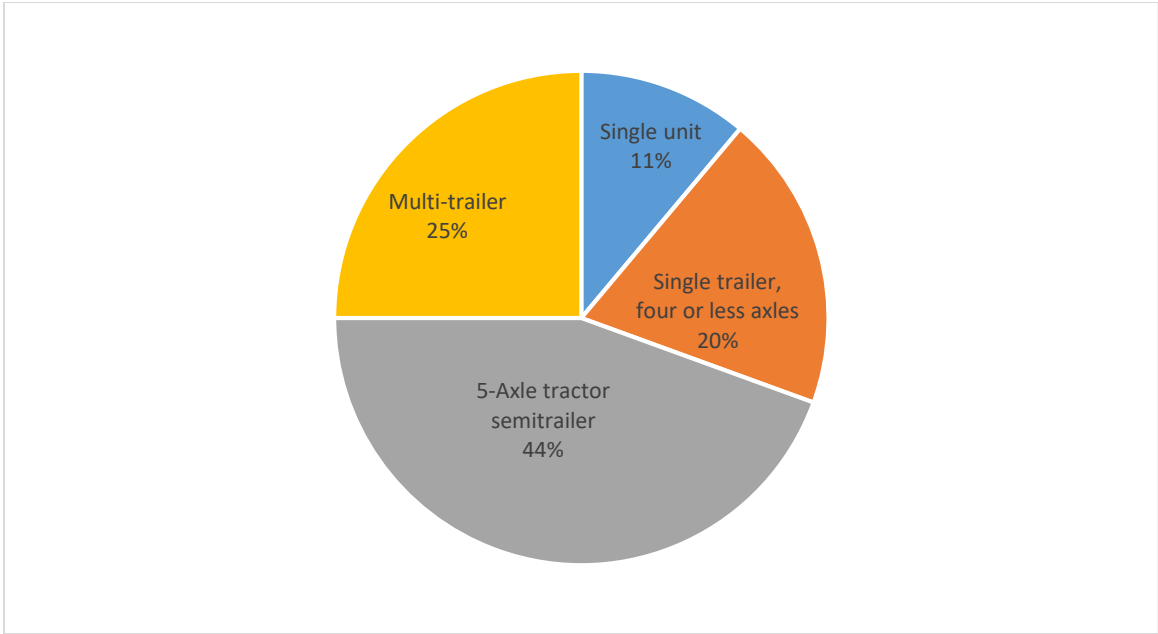
**Figure 3.10. Challenges Related to the Introduction of Automated Truck and Truck Platooning.**

Figure 3.11 shows that the Type 3 survey stakeholders considered rural interstate with two lanes in the same direction and dedicated truck lanes/roadways the most suitable types of roads for a truck platooning operation. None of the respondents expected truck platooning activity on urban and suburban roads and streets.



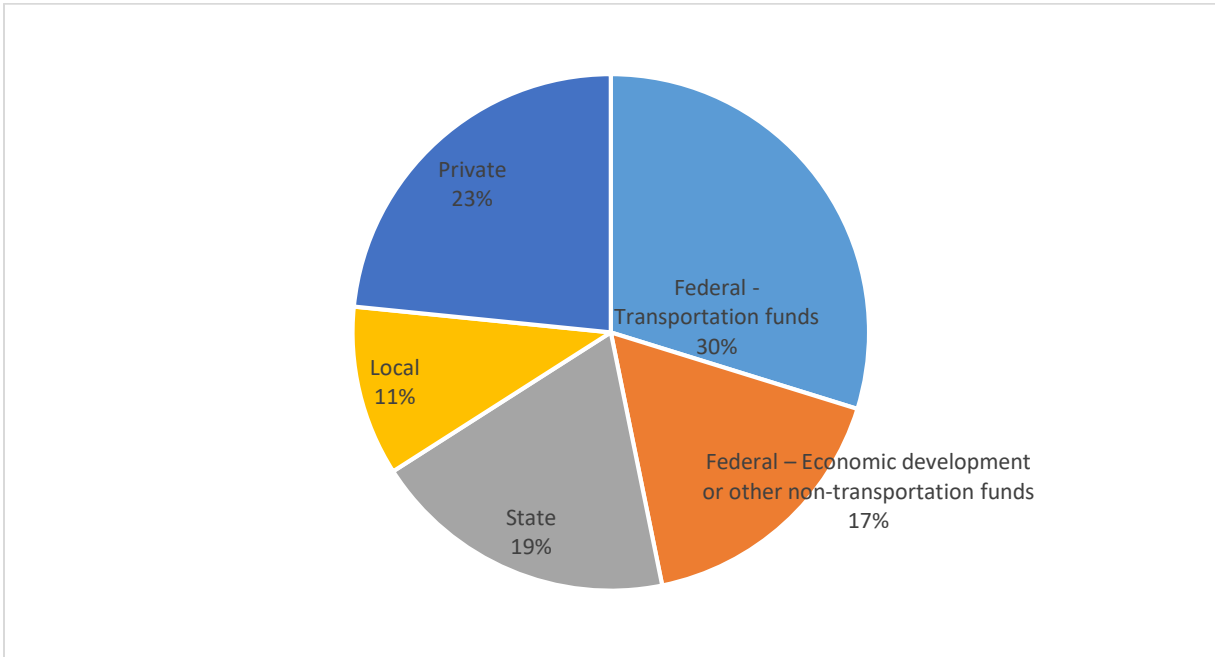
**Figure 3.11. Types of Platooning-Allowable Roads.**

Figure 3.12 shows that all the respondents agreed that five-axle tractor-semitrailers should be allowed to engage in platooning. Some believed that multi-trailers could be authorized for truck platooning, while most respondents were skeptical about allowing platooning operations for the single-unit truck.



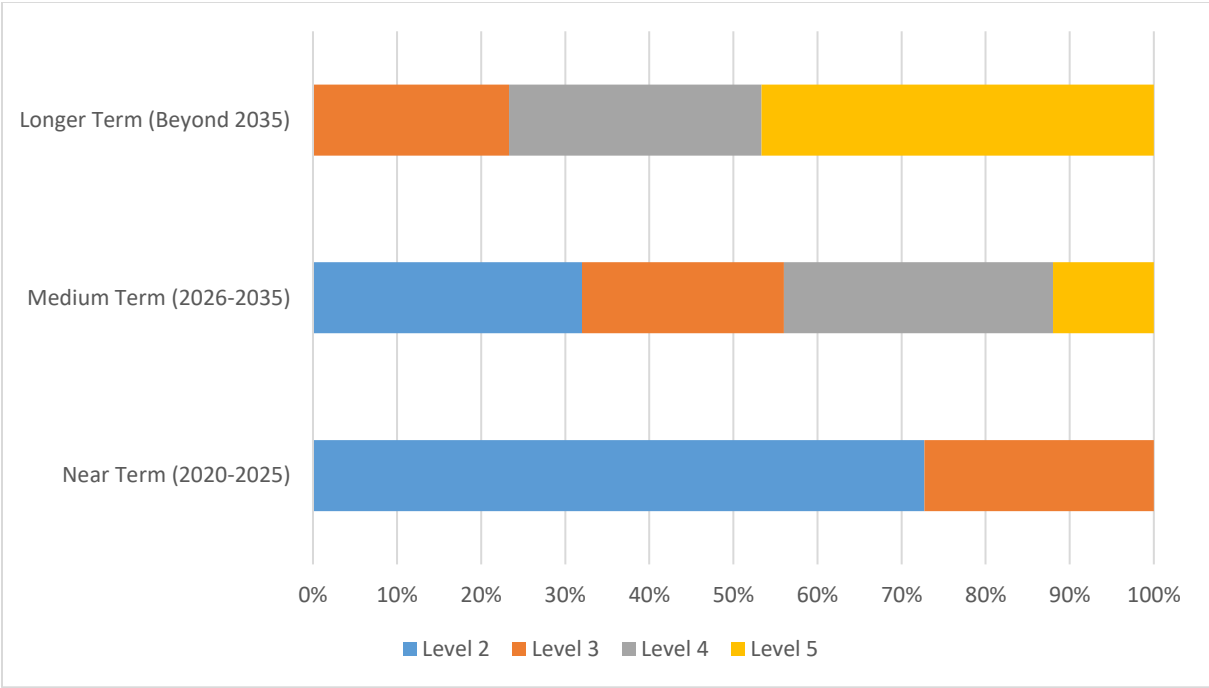
**Figure 3.12. Types of Platooning-Allowable Vehicles.**

Figure 3.13 shows that the survey respondents considered federal transportation funds as the most preferred funding source for infrastructure improvements and accommodations to support automated trucks and truck platooning operations, followed by private funds and state funds.



**Figure 3.13. Preferred Funding Sources for Infrastructure Improvements/Accommodations.**

Figure 3.14 shows survey respondents’ perception of the implementation time frame for different levels of automation technologies. The level of automation technologies used in this survey followed the definition of SAE automation levels.



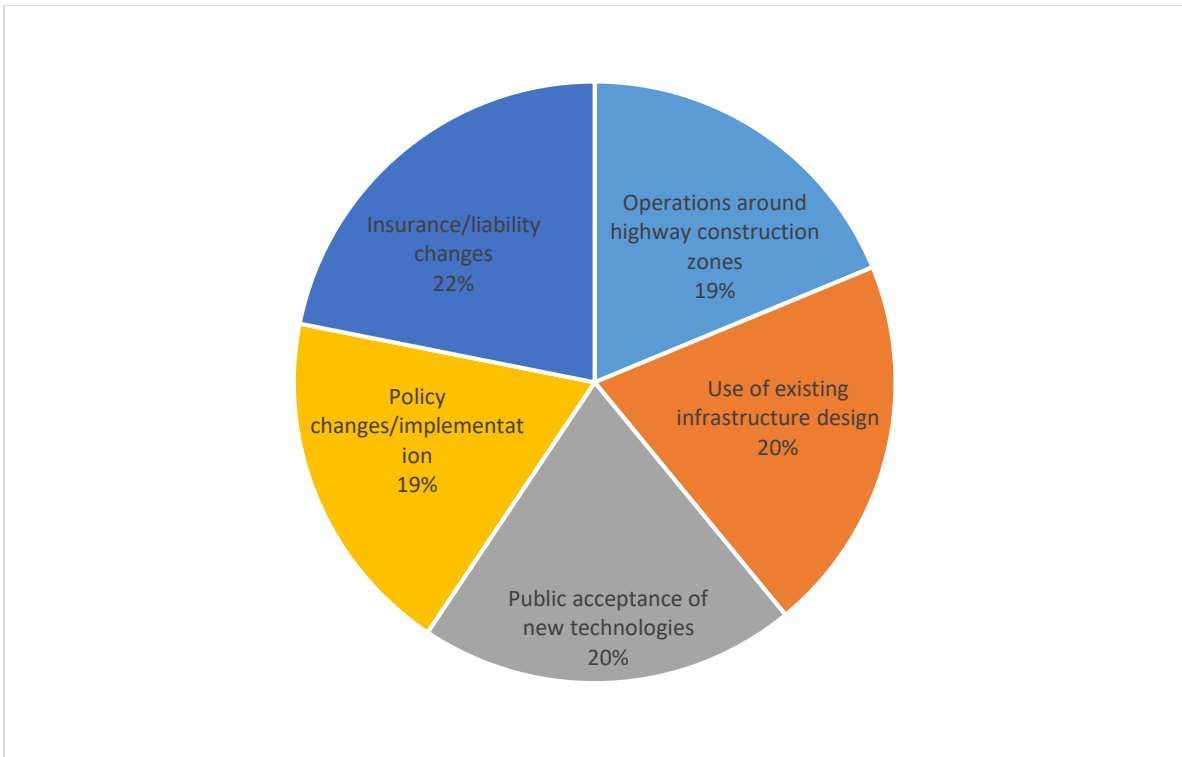
**Figure 3.14. Expected Time Frame of Different Levels of Vehicle Automation.**

Table 3.2 shows the Society of Automotive Engineers (SAE) automation levels. Level 2 automation, in which the vehicle can perform sustained control of both steering and acceleration/deceleration, is expected to be implemented within the next five years. Also, a higher level of automation, wherein all driving tasks can be handled without human intervention, is expected to be seen in the longer term.

**Table 3.2. SAE Automation Levels (52).**

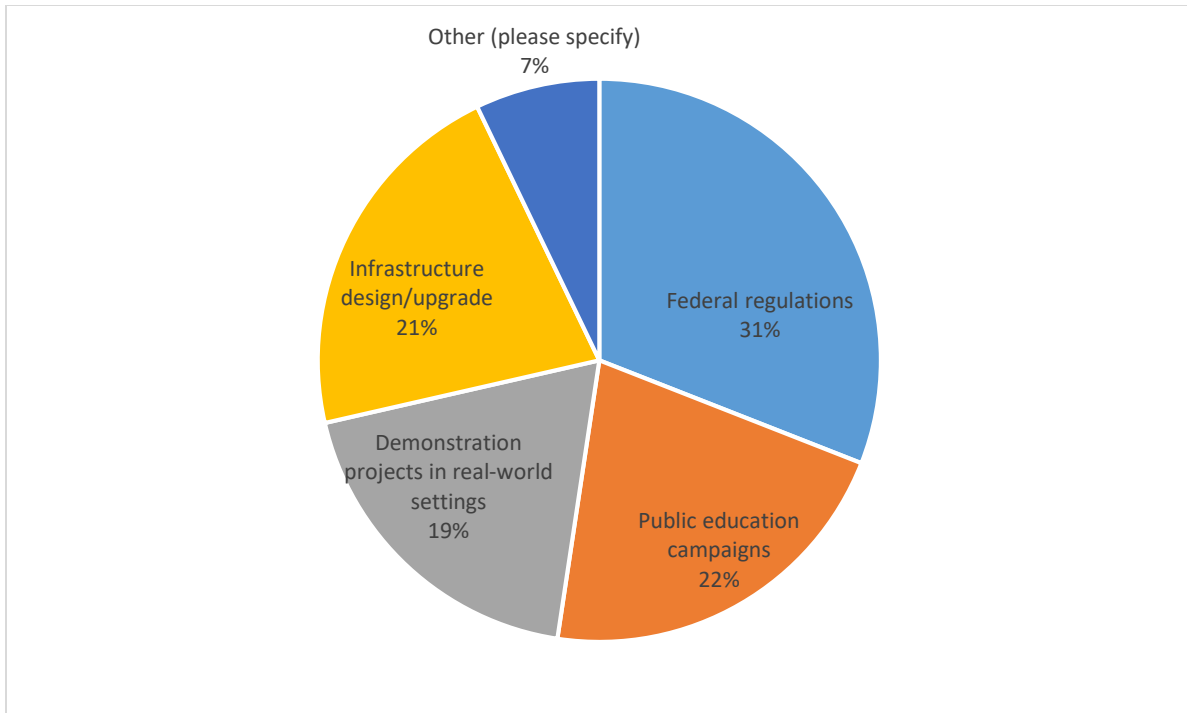
Levels of Automation	Description
Level 0	The human driver does all the driving.
Level 1	An advanced driver assistance system (ADAS) on the vehicle can sometimes assist the human driver with either steering or braking/accelerating, but not both simultaneously.
Level 2	An advanced driver assistance system (ADAS) on the vehicle can actually control both steering and braking/accelerating simultaneously under some circumstances. The human driver must continue to pay full attention (monitor the driving environment) at all times and perform the rest of the driving task.
Level 3	An Automated Driving System (ADS) on the vehicle can perform all aspects of the driving task under some circumstances. In those circumstances, the human driver must be ready to take back control at any time when the ADS requests that the human driver to do so. In all other circumstances, the human driver performs the driving task.
Level 4	An Automated Driving System (ADS) on the vehicle can perform all driving tasks and monitor the driving environment—essentially do all the driving—in certain circumstances. The human need not pay attention in those circumstances.
Level 5	An Automated Driving System (ADS) on the vehicle can do all the driving in all circumstances. The human occupants are just passengers and need never be involved in driving.

Figure 3.15 shows the risk areas during the transition phase to truck automation from the survey. Within the mixed environment of conventional trucks, passenger cars, automated trucks, and platooned trucks, insurance and liability change seemed to Type 3 respondents the most significant complication. The use of existing infrastructure design and public acceptance were other major complications that the public industry expected during the transition period. Especially, passenger car drivers may not feel comfortable driving between platooned trucks or driving in the adjacent lane. Operations around highway construction zones and policy changes/implementation also need to be considered carefully in the future mixed roadway environment. Issues regarding law enforcement are crucial, not only during the transition phase but also for full implementation of new technologies, including truck inspection, truck-involved crashes, data access from an investigator, and potential criminal behavior.



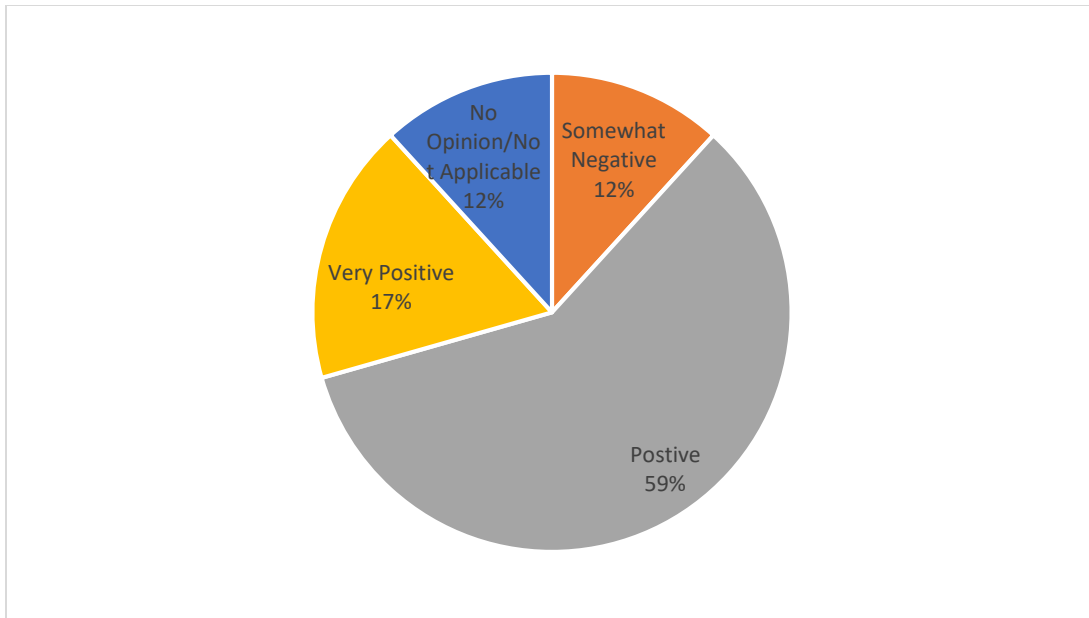
**Figure 3.15. Complications and Risk Areas during the Transition Phase.**

Figure 3.16 shows which major policy issues the survey respondents identified as being associated with truck automation and platooned trucks. While respondents from local MPOs deemed federal regulations to be the major policy issues associated with truck automation and platooned trucks, state DOT personnel placed equal weight on all four options: federal regulations, public education campaigns, demonstration projects in real-world settings, and infrastructure design and upgrade. The respondents commented that law enforcement, lack of funding, and restrictions on using available funds are other policy issues that need to be considered.

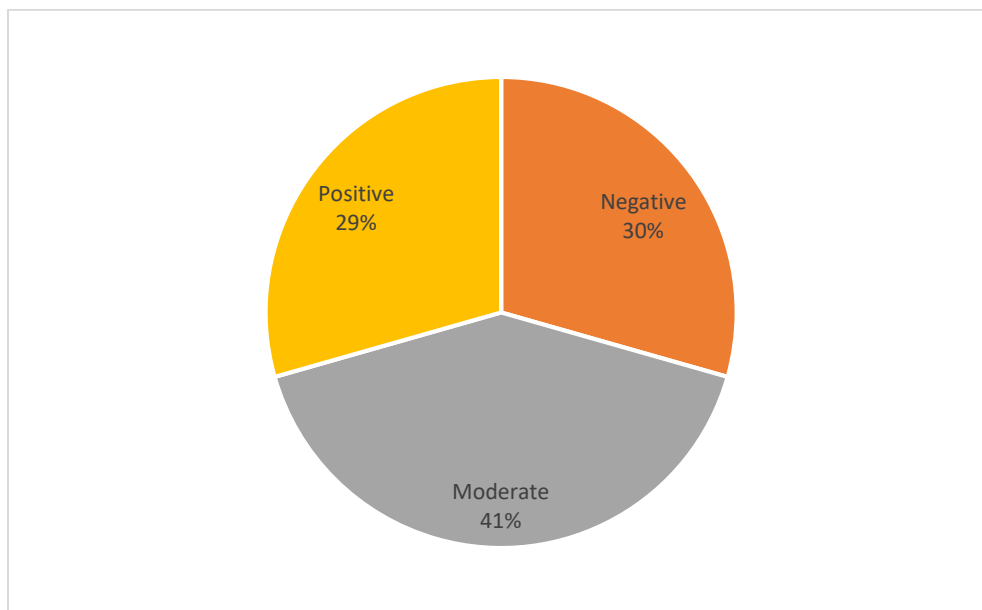


**Figure 3.16. Major Policy Issues Associated with Truck Automation and Platooned Trucks.**

Figure 3.17 shows that more than 50 percent of public stakeholders have positive opinions on the current Texas state programs to achieve higher levels of automation operations, maintenance, or investment. However, they have somewhat neutral views on the impact of implementing automated trucks and truck platooning technologies with traditional infrastructure funding sources. Figure 3.18 shows the anticipated impacts of implementing truck automation and platooning technologies on traditional infrastructure funding.



**Figure 3.17. Survey Respondents' Opinion on Current Texas State Programs.**



**Figure 3.18. Anticipated Impact of Implementing Technologies on Traditional Infrastructure Funding.**

Table 3.3 shows public agency actions that respondents recommended be implemented to design effective policies and accelerate the adoption of automated trucks and truck platooning. Group 3 respondents commonly recommended the interoperability of the new technologies between states, followed by adapting infrastructure design standards, better delineation of rules and responsibilities, and understanding operational safety levels.



**Table 3.3. Recommended Public Agency Actions to Design Effective Policies and Accelerate the Adoption of Technologies.**

<b>Actions Recommend</b>	<b>Rank</b>
Interoperability between states	1
Adapting infrastructure design standards	2
Better delineation of rules and responsibilities	3
Understanding operational safety levels	4
Public sector taking on some of the liability costs/issues	5
Increased certification of equipment	6
Increasing driver training	7

In addition to the information provided in response to the survey questions, the survey respondents provided detailed and vital information to the open-ended questions. Potential planning strategies for making confident decisions despite rapid technological evolution are listed below:

- Collaboration and sharing of information between private and public industry.
- Public education and outreach: continuous well-publicized, long-term demonstration of the effectiveness and safety of the technologies.
- In-depth studies of current transportation network capabilities regarding automation: developing robust scenarios of how travel patterns and behaviors might change in the future.
- Securing sustainable funding sources dedicated to intelligent transportation system infrastructure development.
- Planning for the roadway system and truck fleet to be retrofitted with equipment: planning for new construction and new fleet.

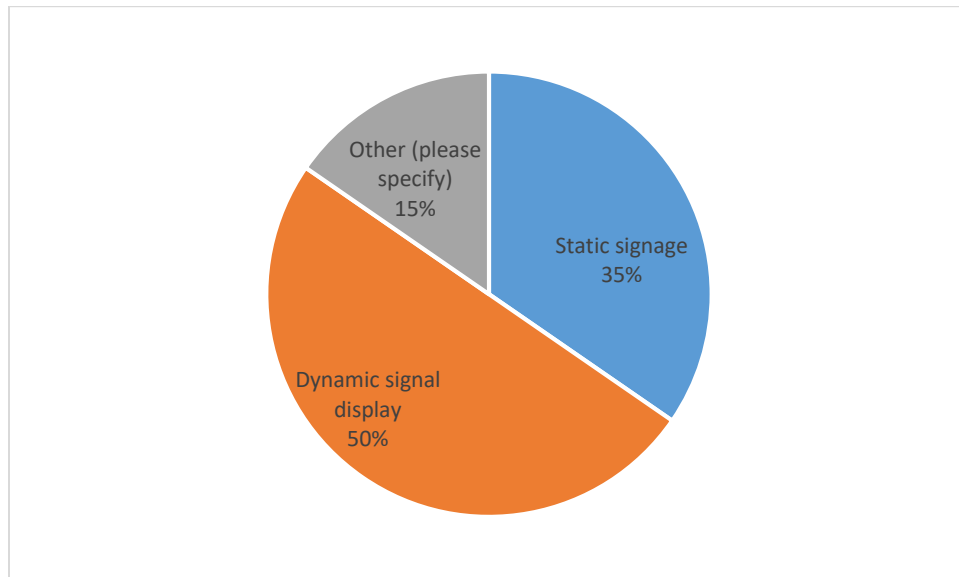
The recommended roles of public agencies in facilitating partnerships and collaboration among various stakeholders interested in automated truck and truck platooning adoption are categorized and listed below:

- Reduce institutional barriers.
- Set up a hub for the new technologies within the DOT to facilitate partnerships: DriveOhio is a good example. Also, create an inventory of stakeholder concerns or limitations and lead efforts to overcome them.
- Form ACT task forces.
- Address real day-to-day law enforcement side. The way to integrate the new technologies into law enforcement needs to be addressed by the following list of questions:
  - What does a state patrolman do when an automated truck breaks down on the highway?
  - How are platooned trucks integrated with passenger vehicles?

- How can the misuse of technologies be prevented, especially if the vehicle can be leased?
- How will a patrolman write a crash report?
- How is evidence collected from the self-driving truck?
- Who is prosecuted if a self-driving truck causes a fatal crash?
- Focus on the safety aspect of the traveling public.
- Develop policies that clearly state how automated freight transport and platooning may be conducted on state facilities.

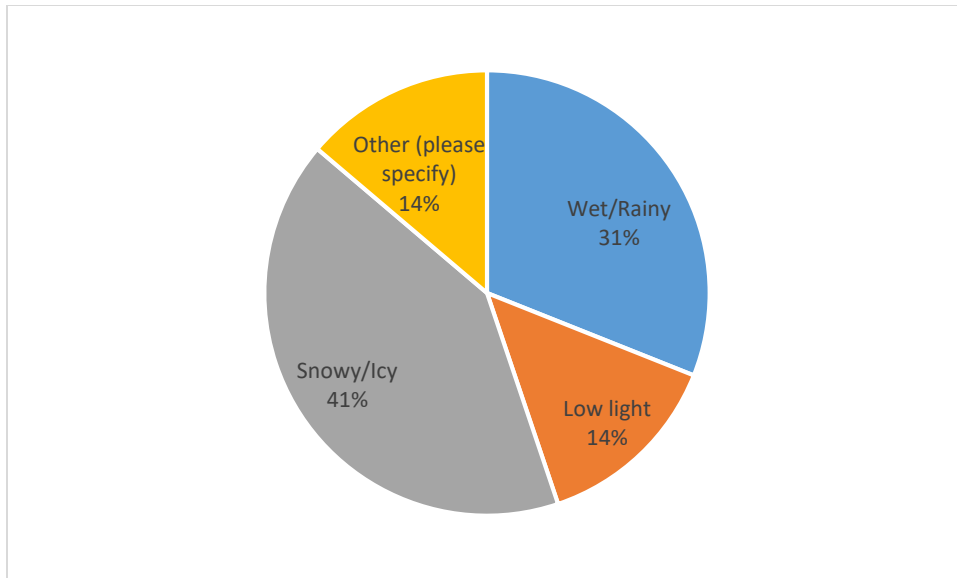
*Technical and Infrastructure Implications of Automated Trucks and Truck Platooning*

Figure 3.19 shows that most of the respondents mentioned that dynamic signals could be used as a communication tool between truck platooning and automated truck corridors/segments and highway users. Using mobile devices, such as smartphone applications, is also highly recommended.



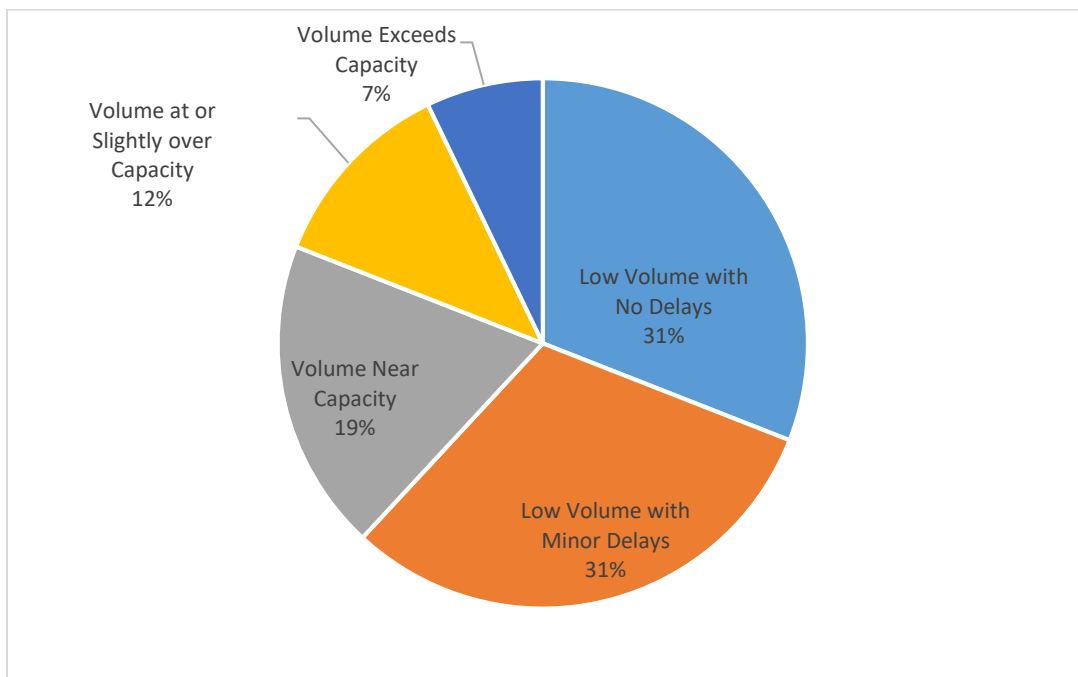
**Figure 3.19. Potential Communication Method between Highway Users and Truck Platooning and Automated Truck Corridors/Segments.**

Figure 3.20 shows that because of high risk, the majority of respondents recommended that truck platooning not be permitted under snowy and icy conditions. Wet and rainy conditions were also mentioned as being prohibitive to truck platooning, as were low visibility conditions, such as dust storms and blizzards.



**Figure 3.20. Weather and Visibility Conditions in Which Truck Platooning Should Not Be Permitted.**

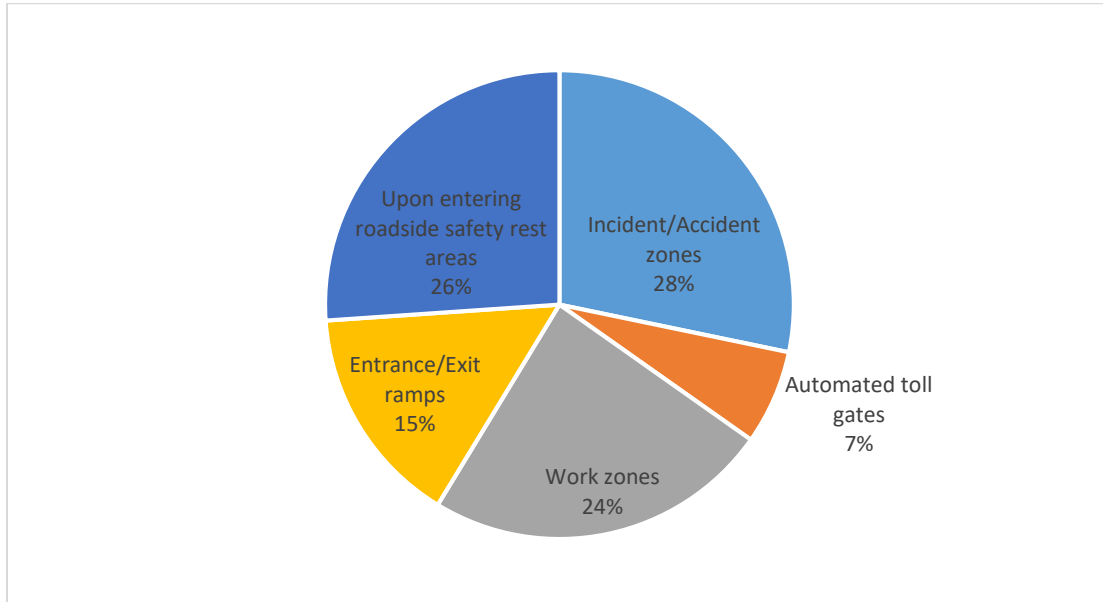
Figure 3.21 shows that most of the respondents did not envision operating truck platooning when traffic volume exceeds roadway capacity. They highly recommended permitting truck platooning under low traffic volume conditions with no or minor delays.



**Figure 3.21. Traffic Volume Conditions to Permit Truck Platooning.**

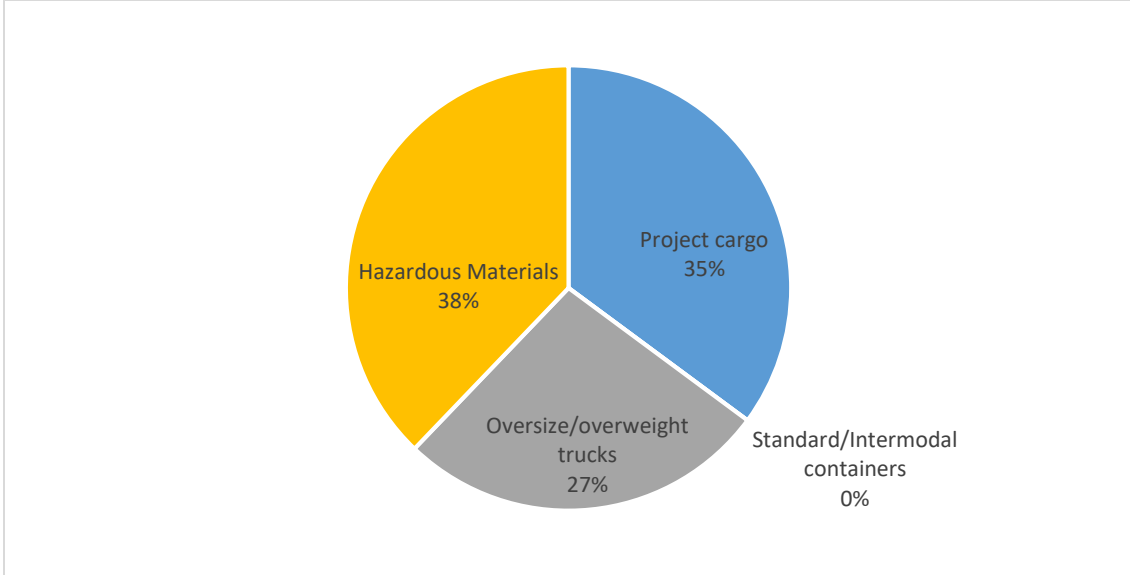
Approximately 75 percent of respondents did not anticipate truck platoons taking place in more than one lane at a time. Additionally, 69 percent of respondents felt that a platoon should not be allowed to change lanes when they are not in exclusive truck lanes.

Figure 3.22 shows that disengaging truck platooning was highly recommended in incident/accident zones and when entering roadside safety rest areas, as well as in work zones and on entrance/exit ramps. Moreover, the respondents suggested disengaging platoons in congested traffic conditions.



**Figure 3.22. Areas Where Truck Platooning Needs to Disengage.**

Figure 3.23 shows that a majority of the respondents believed that trucks transporting hazardous materials and project cargo (e.g., windmill blades, bridge beams, and oversized equipment) are not suitable for platooning. None of the respondents believed standard and intermodal containers should be restricted from being transported by platooning trucks.



**Figure 3.23. Type of Cargo for Which Platooning Trucks Should Not Be Permitted.**

Infrastructure changes like interchanges, ramp spacing, and pavement markings will be necessary to implement automated and platooned truck technologies. Some respondents recommended signage movements, as well as a clear and early notification system of upcoming construction zones and hazards. The respondents commonly responded that drivers should initiate the formation of a truck platoon, followed by a company operation center or an infrastructure owner-operator provided center.



## **CHAPTER 4. ASSESSMENT OF PLANNING AND POLICY IMPACTS**

### **INTRODUCTION**

The objective of Task 3 was to assess the planning and policy impacts for TxDOT that will occur as platooning and automated trucks are introduced on Texas highways under a variety of scenarios to be defined further in other tasks on infrastructure and operational needs. Often forgotten or delegated to an afterthought in the discussion of the impact of both platooning and automated vehicles are the transportation planning and policy issues associated with implementing their use on existing roadways. Impact assessments of (a) how they might be managed or interact with existing or future infrastructure and other vehicles and (b) broad changes in planning processes and system design may be needed to accommodate both planning and policies. Previous TxDOT research indicated that these impacts could be broad-ranging, affecting:

- Overall infrastructure costs.
- Freight routing selection and subsequent commodity costs to consumers.
- The need for separate/specialized freight transportation facilities.
- The number and location of intermodal exchange nodes along the highway system.
- The average speeds at which mixed (freight and passenger) traffic may flow—even within a broader autonomous vehicle/connected vehicle (AV/CV) operating environment.

In this tech memo, the research team reviewed the planning process of TxDOT, MPOs, and other local/regional levels. Also, all levels of statewide planning documents, including the TFMP, the TTP, MPOs' MTP, and MPO TIPs, are cataloged.

### **REVIEW OF STATEWIDE PLANNING PROCESS**

#### **TxDOT Planning Process**

Figure 4.1 shows the TxDOT planning and document programming documents. The review of the process is summarized below.

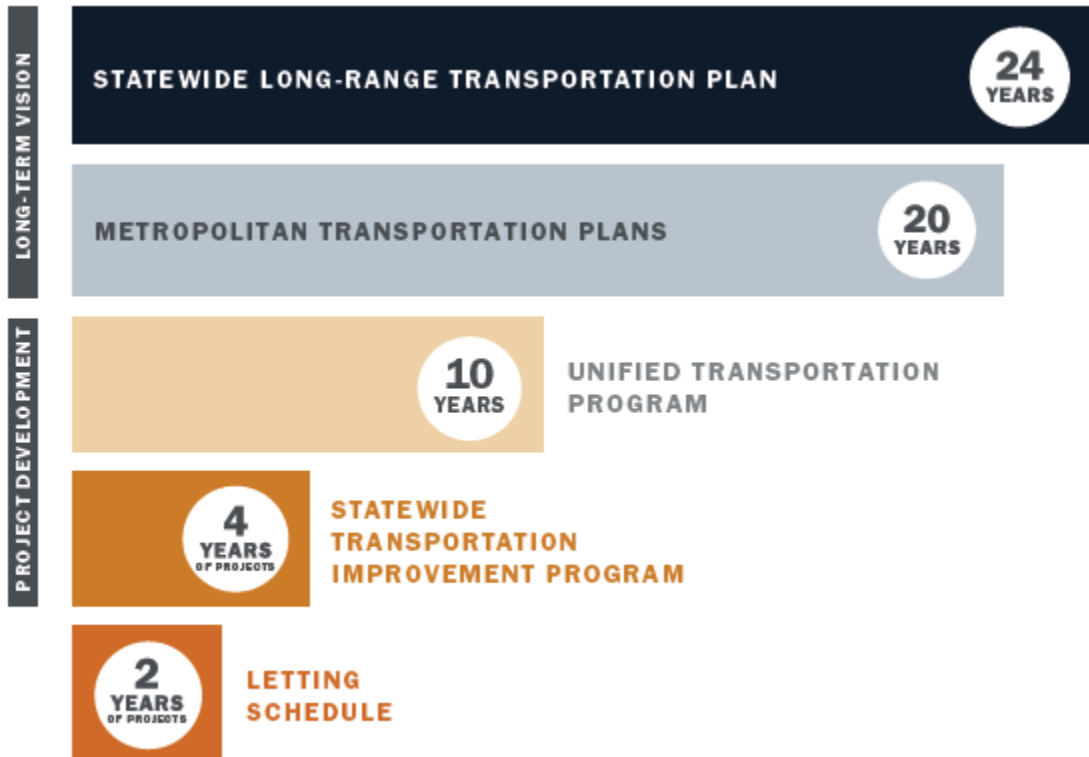
- For 30-year planning horizons the findings were as follows:
  - The TTP is a policy document that guides planning and programming decisions for the development, management, and operation of the statewide, multimodal transportation system in Texas. The plan documents existing infrastructure and funding needs for all passengers and freight modes in the state over a 25-year horizon.
  - The TTP goal areas identified by the Texas Transportation Commission are aligned with the strategic plan and the national goals defined in the Moving Ahead for Progress in the 21st Century (MAP-21) Act.

- The national highway performance goal areas listed in MAP-21 are as follows: (1) safety, (2) infrastructure condition, (3) congestion reduction, (4) system reliability, (5) freight movement and economic vitality, (6) environmental sustainability, and (7) reduced project delivery delays.
- The latest TxDOT 2019-2023 Strategic Plan includes seven strategic goals, as follows: (1) promote safety, (2) deliver the right projects, (3) focus on the customer, (4) foster stewardship, (5) optimize system performance, (6) preserve our assets, and (7) value our employees.
- The identified seven goals in TTP 2040 include (1) safety, (2) asset management, (3) mobility and reliability, (4) multimodal connectivity, (5) stewardship, (6) customer service, and (7) financial sustainability.
- For 10-year planning horizons the findings were as follows:
  - The Unified Transportation Program (UTP) aims to identify and evaluate candidate projects designed to meet transportation needs outlined by TxDOT and MPOs. The UTP is a 10-year, midrange planning document developed to guide the state's transportation project development and authorization.
  - The funding categories identified in the UTP are as follows: (1) preventive maintenance and rehabilitation, (2) metro and urban area corridor projects, (3) nontraditionally funded transportation projects, (4) statewide connectivity corridor projects, (5) congestion mitigation and air quality improvement, (6) structures replacement and rehabilitation, (7) metropolitan mobility and rehabilitation, (8) safety, (9) transportation alternative programs, (10) supplemental transportation projects, (11) district discretionary projects, and (12) strategic priority projects.
- For 4-year plans, the findings were as follows:
  - The Statewide Transportation Improvement Program (STIP) is TxDOT's four-year capital improvement program. The STIP includes both a rural transportation improvement program and an MPO transportation improvement program and represents the transportation projects and services to be constructed or implemented statewide.
- For the Statewide Freight Plan, the review found that:
  - The Texas Freight Mobility Plan 2017 was developed to identify multimodal challenges, policies, programs, investment strategies, and data needed to enhance freight mobility. The plan also aimed to provide efficient, reliable, and safe freight transportation and to improve the state's economic competitiveness.
  - As part of TFMP development, TxDOT and the state's MPOs designated a network of roadways important for freight transportation in order to comply with a federal mandate in 2015 Fixing America's Surface Transportation Act (FAST Act). The network is made up of both roadways previously designated as part of the Texas Highway Freight Network and new routes identified as critical rural



freight corridors and critical urban freight corridors based upon FAST Act-defined criteria, input from TxDOT, and input from MPOs, respectively, before final adoption by the Texas Transportation Commission.

- The freight plan identified eight freight-specific goals, as follows: (1) safety, (2) economic competitiveness, (3) asset preservation and utilization, (4) mobility and reliability, (5) multimodal connectivity, (6) stewardship, (7) customer service, and (8) sustainable funding.



**Figure 4.1. TxDOT Planning and Programming Documents (53).**

### Local and Regional Planning Process

Figure 4.2 shows a map of Metropolitan Transportation Offices (MPOs) in Texas and Figure 4.3 shows the steps in a performance-based planning process. For the local and regional planning process, the review showed that:

- For 30-year planning horizons:
  - The Metropolitan Transportation Plan is a federally required document that describes comprehensive, multimodal transportation needs within each MPO’s boundary to improve the quality of life for the residents.
  - The Texas Rural Transportation Plan (TRTP) is developed to cover areas outside of MPO boundaries. The TRTP is also a multimodal transportation plan, which is

a blueprint for the planning process in rural areas that guides TxDOT, local and regional decision-makers, and all transportation stakeholders.

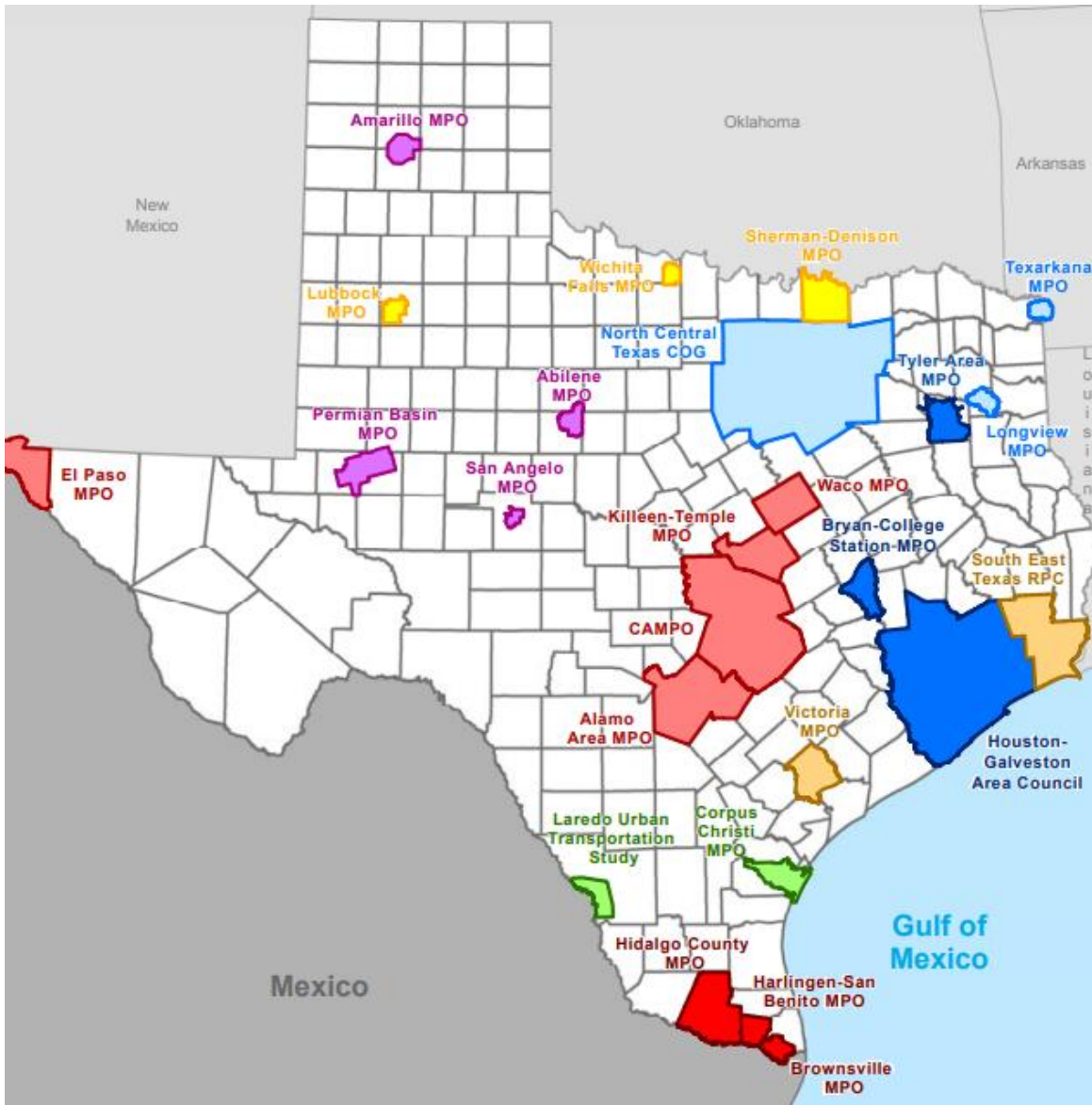


Figure 4.2. Texas MPOs (54).

- For 4-year plans:
  - Every MPO is required to develop a TIP cooperatively by local and state transportation entities. As a STIP, the TIP also serves as a short-term programming document that lists approximately four years of funded multimodal transportation projects. The projects are consistent with a rural long-range plan or MTPs.

- The TIP is a stand-alone document specifically approved at the local level. Federal funding cannot be expended on a TIP project unless the project is listed individually or by reference in the STIP.



**Figure 4.3. Performance-Based Planning Process (55).**

Although platooning and automated trucking are expected to start operations on interstate corridors and mostly in rural areas of the state, the potential exists for rapid expansion of these practices to the broader designated Texas Highway Freight Network as technology and experience grows. TxDOT’s statewide planning function must account for the physical infrastructure and operational expansion in future plans. As a result, it is vital to include within this project a more thorough and robust component examining platooning and automated trucks’ planning impact on commercial freight transportation upon the wider, designated Texas Highway Freight Network and/or to identify a subset of that system in which platooning or automated truck operations can take place. The performance-based planning process shows the steps to be considered (Figure 4.3).

## **LIST OF PLANNING DOCUMENTS**

### **Statewide**

- Texas Freight Mobility Plan 2017.
- Texas Transportation Plan 2040.
- Texas Transportation Plan 2050.
- Statewide Long-range Transportation Plan 2035.
- Texas Rural Transportation Plan 2035.
- TxDOT 2019–2023 Strategic Plan.
- TxDOT 2019 Unified Transportation Program.
- Texas Statewide Transportation Improvement Program.

### **Metropolitan Planning Organizations**

- Metropolitan Transportation Plan and Transportation Improvement Plan:
  - Abilene MPO.
  - Amarillo MPO.
  - Austin MPO (CAMPO).
  - Beaumont–Port Arthur MPO (SETRPC).
  - Brownsville MPO.
  - Bryan-College Station MPO.
  - Corpus Christi MPO.
  - Dallas–Fort Worth MPO (NCTCOG).
  - El Paso MPO.
  - Harlingen-San Benito MPO.
  - Hidalgo County MPO.
  - Houston-Galveston MPO (HGAC).
  - Killeen-Temple MPO (KTMPO).
  - Laredo MPO.
  - Longview MPO.
  - Lubbock MPO.
  - Permian Basin MPO.
  - San Angelo MPO.
  - Alamo Area MPO.
  - Sherman-Denison MPO.
  - Texarkana MPO.
  - Tyler Area MPO.
  - Victoria MPO.
  - Waco MPO.
  - Wichita Falls MPO.

## **Other Local/Regional Plans**

- TxDOT I-45 Freight Corridor Plan.
- Freight North Texas—The North Central Texas Regional Freight System Inventory.
- Regional Goods Movement Study—Houston-Galveston Area Council.

## **Outside Texas**

- Strategic Planning for Connected and Automated Vehicles in Massachusetts—Massachusetts Department of Transportation.
- Automated and Connected Vehicle (ACV) Roadmap: Actions to Prepare the Greater Charlotte Region—Centralina Council of Governments.
- Strategic Plan for Connected and Automated Vehicles (CAV Plan)—Maryland Transportation Authority.
- Florida’s Connected and Automated Vehicles (CAV) Business Plan—Florida Department of Transportation.
- Pennsylvania Joint Statewide Connected and Automated Vehicles Strategic Plan—Pennsylvania Department of Transportation.
- Connected and Automated Vehicle Technology Strategic Plan—Michigan Department of Transportation.
- Connected and Automated Vehicle Program Plan—Virginia Department of Transportation.



## **CHAPTER 5. METHODOLOGY TO DEVELOP GUIDANCE FOR COMMERCIAL TRUCK PLATOONING**

### **SIMULATION METHODOLOGY**

The research team developed operational guidance to help TxDOT and other stakeholders prepare deployment of truck platooning. Researchers used a simulation-based approach to analyze the impact of truck platooning on infrastructure. The purpose of the simulation was to assess and evaluate conditions that could inform optimum platooning operation. The optimum operation consists of uncongested facilities with free-flow traffic, which means platooning trucks and other vehicles in the traffic stream can change lanes as desired to maintain speed.

Texas A&M Transportation Institute (TTI) evaluated the impact of truck platooning on traffic operations using the VISSIM simulation model. The VISSIM simulation consisted of a hypothetical 5-mi, two-lane freeway section created to evaluate the impact and interactions between ramp traffic and two-truck platoons on traffic flow. Researchers ran each simulation for 60 minutes, then removed the first 5 minutes from the data since they were intended as a warm-up period. Researchers used five simulation runs with different random seeds for each scenario to account for randomness in traffic. The same set of five random seeds were used for each scenario. Researchers set the speed limit for both the freeway and ramp lanes to be 65 mph. Researchers provided a 3-mi open stretch of freeway before the physical gore of the first ramp. This 3-mi section allowed platooning trucks to reach their desired intra-platoon gap prior to arriving at the freeway-ramp gore.

The research team considered the following scenarios during the simulation study:

- Under different ramp configurations.
  - Single entrance ramp (with and without auxiliary lanes).
  - Double entrance ramp (with and without auxiliary lanes).
  - Entrance-exit ramp (with and without auxiliary lanes).
- With/without lane restriction policies (free lane selections versus restricting platooning trucks to right lane).
- For various traffic demand (LOS-C and LOS-D).
- Including special lane change policies for platooning trucks near ramp sections.
  - Cooperative lane change.
- Varying the percentage of trucks forming two vehicle platoons on the simulated corridor.

### **POLICY ISSUES**

The results of the simulation study provide the basis for outlining various optimal truck platooning policies, as illustrated in Table 5.1.

**Table 5.1. Policy Issues for Truck Platooning.**

<b>Categories</b>	<b>Issues</b>	<b>Descriptions</b>
<b>Presence of auxiliary lane</b>	How does truck platooning impact the mobility on ramp section with and without auxiliary lane?	Ramp sections without auxiliary lanes can be adversely affected by truck platooning. It is important to understand the impact of truck platooning on different ramp sections to identify corridors most suitable for truck platooning.
<b>Lane restriction policy</b>	How do truck platooning lane restrictions impact freeway performance?	Restricting platooning trucks to the right lane can make it harder for vehicles to merge onto and diverge from the freeway.
<b>Traffic condition</b>	Should truck platooning be allowed in corridors with LOSs lower than LOS-C?	Highways in urban areas generally tend to have worse LOSs (e.g., LOS-D, LOS-E) than rural areas (e.g., LOS-B, LOS-C). Understanding the effect of truck platooning under different LOSs will aid in corridor selection for truck platooning.
<b>Ramp lane change policy</b>	Should platooning trucks initiate lane change toward the adjacent left lane when a merging vehicle is present on the ramp?	Commercial vehicles with Level 2 automation have the ability to change lanes without breaking platoon. Traffic operation might improve when platooning trucks change lanes to facilitate merging. Thus, it is important to analyze this policy.
<b>Ramp spacing</b>	Does truck platooning impact freeway operations at different ramp spacing?	Having this knowledge can aid in corridor selection.

## **FINDINGS**

This study analyzed the impact of truck platooning on freeway performance for different infrastructure and truck-platooning-related factors. The researchers used a microscopic simulation software (VISSIM) to model truck platooning. Furthermore, researchers used a deterministic lane change model for modeling lateral control of platooning trucks. The results provided insight on policy decisions for implementing truck platooning. Following is a summary of observations and recommendations for various policy-related factors:

- Auxiliary lanes tend to slightly improve freeway performance for the truck platooning environment. Consequently, it is preferable to select corridors that provide auxiliary lanes for the ramps.
- Restricting platooning trucks to the right lane adversely affects freeway performance.
- Corridors with a LOS-C or higher are most suitable for deployment. Thus, rural corridors are more suitable for pilot deployment of truck platooning.
- Cooperative lane changes by platooning trucks to accommodate merging vehicles did not improve freeway or ramp performance. Platooning trucks should not be required to move to the left lane when approaching entrance ramps.



- Freeway performance for double entrance ramps at 700 ft apart and 2,500 ft apart was not impacted by truck platooning.
- Weaving length in the entrance-exit model is the deterring factor when selecting a corridor for truck platooning. Thus, it is preferable to select corridors with weaving sections that are greater than 1,000 ft in length.



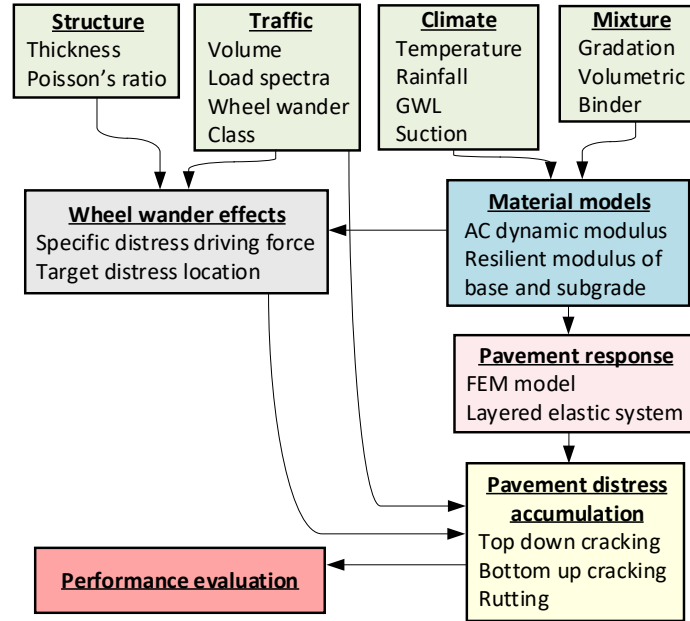
## **CHAPTER 6. ASSESSMENT OF TECHNICAL AND PERFORMANCE IMPACTS ON TEXAS PAVEMENTS**

### **INTRODUCTION**

The objective of Task 4 was to assess the impact of platooning and autonomous trucks on Texas pavements. Platooning and autonomous trucks are very different from traditional traffic vehicles. The former travel more consistently in paths within a travel lane, while the latter have more random travel paths. In addition, platooning and autonomous trucks induce different load configurations and increased frequency of axle loads. All of these factors bring new challenges to current pavement infrastructure, which is designed on the basis of traditional traffic loading. For instance, this new type of traffic will increase the possibility of aggravation of pavement distresses like cracking, rutting, faulting, etc. Therefore, it is critical to evaluate the impacts of platooning and automated trucks on current pavement infrastructure in terms of traffic loading and performance. This chapter introduces a comprehensive analysis framework for pavement performance for both traditional and autonomous trucks characterized by considering scenarios both with and without lateral wheel wandering.

### **ANALYSIS FRAMEWORK FOR PERFORMANCE EVALUATION OF FLEXIBLE PAVEMENT**

A comprehensive pavement performance evaluation framework was used to evaluate the influence of truck platooning and automation on the performance of flexible pavements in Texas. Characteristic properties of individual pavements, including pavement structure, traffic, environmental conditions and materials properties were considered in the analysis framework for the evaluation of pavement performance. A flow chart describing the components of the evaluation framework is presented in Figure 6.1. Asphalt mixture and unbound materials information, together with the environmental inputs, are required in the material models for the prediction of key material properties for the surface layer, base layer, and subgrade, respectively. The environmental inputs are used in the material models to predict the changes in the material properties due to the seasonal variations in temperature and moisture conditions. The pavement response model is used to compute critical stresses and/or strains in the different layers in the pavement structure due to the application of traffic loading. Traffic data required for the evaluation of the effect of truck platooning on pavement performance include the number of axle load repetitions and distribution of axle load magnitudes for each vehicle class. The predicted stress-strain response as well as the distribution and magnitude of the axle load configurations were considered for the performance analysis of the individual pavement sections.



**Figure 6.1. Flowchart for the Pavement Performance Analysis Framework Used in the Study.**

## TRAFFIC DATA COLLECTION

Traffic information for individual or groups of pavements is needed for the accurate evaluation and prediction of pavement life and performance. The Pavement Mechanistic-Empirical (ME) Design Guide (56) used a characterization model that categorizes the total traffic for a given pavement section into actual load spectrum for each truck class, axle type, and number of tires. A similar approach to traffic characterization has been used in the NCHRP 1-41 (57). In this work, a hierarchical approach is employed to determine the normalized axle load distribution for each axle and vehicle types according to the availability of collected traffic and weigh-in-motion (WIM) data, indicated as below:

- In cases where complete or partial traffic characteristics and site-specific WIM data are available, the actual load spectrum and load number in specific load intervals are applied into the following analysis submodels for rutting, top-down cracking and bottom-up cracking.
- If WIM traffic characteristics and summary data are not available, a predictive load spectrum using default probability density for each traffic category based on the average annual daily truck traffic (AADTT) will be used instead.

## Categorization of Traffic Loads

The WIM traffic data (if available) collected from the Long Term Pavement Performance (LTPP) database are presented as the annual number of axle loads for each vehicle class and axle type. FHWA characterizes the total traffic for a given pavement section into 13 vehicle classes.

Vehicle Classes 1 to 3 are the light load groups, which do not have significant effects on pavement distress. Only heavy load Vehicle Classes 4 to 13 are considered in the traffic analysis. The axle types for each vehicle class are categorized as single, tandem, tridem, or quadrem axles, and each axle has single or dual tires. Based on FHWA vehicle classification, all axles of Vehicle Classes 4–5 and single axles of Class 6–7 vehicles have single tires, while the others have dual tires. According to the vehicle class, the axle type, and the number of tires, the traffic load is characterized into the eight categories shown in Table 6.1. The traffic data obtained from the LTPP database for the individual pavement sections are categorized into these eight categories. These load categories are used as traffic inputs for the pavement performance evaluation, according to NCHRP 1-41 (57).

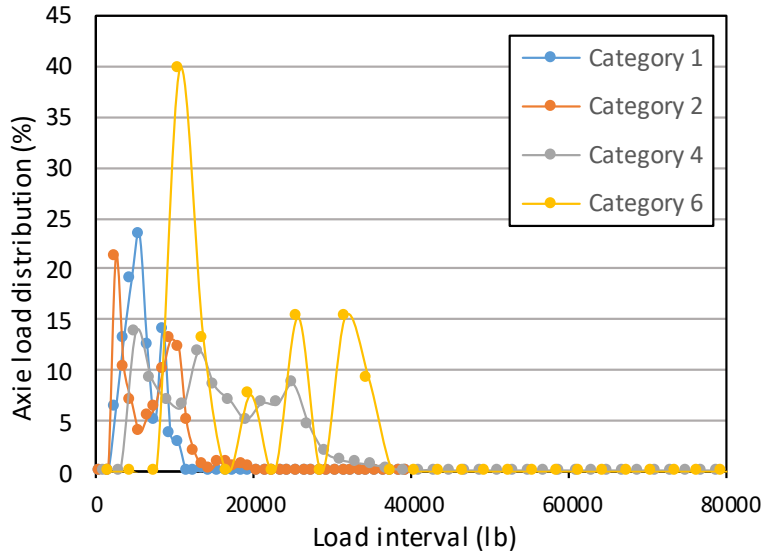
**Table 6.1. Vehicle Categories Classified by Vehicle Class, Axle Type, and Number of Tires (57).**

Vehicle Class	Single axle	Tandem axle	Tridem axle	Quadrem axle
4	1	3	5	7
5				
6		4	6	8
7				
8				
9				
10				
11				
12				
13				
14				

single tire     dual tire

### Axle Load Distribution

For the sections with the comprehensive collection of traffic load, the exact annual or daily number of load applications in each load interval can be applied directly in the analysis framework for performance evaluation. For sections with only AADTT data, a model of the cumulative axle load distribution (CALD) of traffic categories for pavement sections is necessary to predict load spectrum in each load interval based on the AADTT.

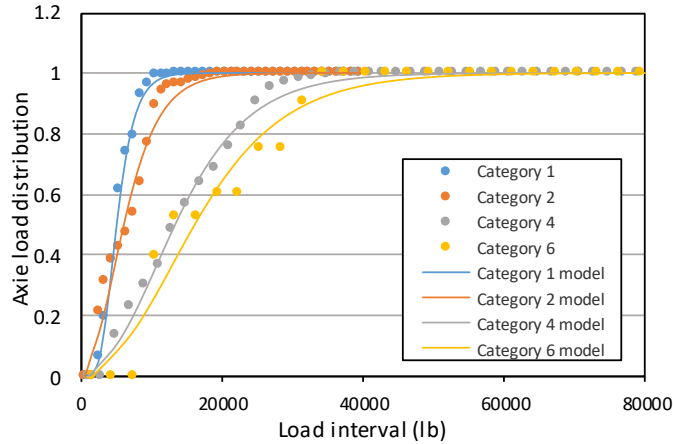


**Figure 6.2. Annual Axle Load Distribution for Traffic of LTPP Section 48-1050 in 1992.**

The CALD is obtained by adding the individual load intervals in each load category. Figure 6.2 shows the normalized axle load distributions of each category for LTPP section 48-1050 in 1992. For the same section, the CALD of traffic loads follows a sigmoidal-shaped curve shown in Figure 6.3. The statistical properties of the CALD is well described using the Gompertz model presented in Equation (6.1), according to NCHRP 1-41 (57):

$$y = \alpha \exp[-\exp(\beta - \gamma x)] \tag{6.1}$$

The collected WIM traffic data for a given section are used to obtain the Gompertz model parameters for that section. The plot in Figure 6.3 showing the fit of the Gompertz model with the CALD of the obtained WIM data indicates that the Gompertz model provides a reasonable estimate of load distribution. In cases where WIM traffic characteristics and summary data are not available, the CALD is predicted with the Gompertz model using the default values for each category provided in NCHRP 1-41 (57). The predicted load spectra for the individual load interval are then estimated from the calculated CALD.



**Figure 6.3. Cumulative Axle Load Distribution versus Load Intervals for All Categories of LTPP Section 48-1050 in 1992.**

### Estimation of Number and Distribution of Axle Loads

The axle load distribution for each load category is obtained from the actual load spectrum collected and characterized from WIM data for each axle type within a certain vehicle class. In some cases, WIM data are not available on the LTPP database for the characterization of the axle load distribution. For these cases, the AADTT is used to estimate the number of axle loads for each category according to a series of default distributions.

First, to obtain annual axle load repetition for each vehicle and axle type, AADTT data are expended to the annual number of trucks for each vehicle class based on a given normalized truck class distribution using the following equation:

$$ANT_k = AADTT \cdot NTP_k \cdot 365 \tag{6.2}$$

where  $ANT_k$  is the annual number of trucks for Vehicle Class  $k$ , and  $NTP_k$  is the normalized truck class distribution factor of Class  $k$ . NCHRP 1-41 (57) provides default vehicle class distribution factors obtained from the principal arterials in the roadway function class and the major multi-trailer truck route in the truck traffic classification. The default nominalized vehicle class distribution factor is shown in Table 6.2.

**Table 6.2. Default Normalized Vehicle Class Distribution Factor (57).**

Vehicle class	4	5	6	7	8	9	10	11	12	13
Distribution factors (%)	1.8	24.6	7.6	0.5	5.0	31.3	9.8	0.8	3.3	15.3

Then, the annual number of trucks for each vehicle class is converted to the number of axle types per vehicle. Each vehicle has a certain number of axles with an axle type of single, tandem, tridem, or quadrem. Table 6.3 shows the typical number of axles for each vehicle. Knowing the

total number of trucks for each vehicle class  $ANT_k$ , obtained in Equation (6.3), and the typical number of axles for each vehicle, the annual number of axle loads for each vehicle class and axle type is calculated as:

$$NA_{ka} = ANT_k \cdot NAT_{ka} \quad (6.3)$$

where  $a$  is a specific axle type,  $NA_{ka}$  is the annual number of axle loads for Vehicle Class  $k$  and axle type  $a$ , and  $NAT_{ka}$  is the typical number of axles for each vehicle listed in Table 6.3.

**Table 6.3. Typical Number of Axles for Each Vehicle (57).**

Vehicle class	Single axle	Tandem axle	Tridem axle	Quadrem axle
4	1.62	0.39	0.00	0.00
5	2.00	0.00	0.00	0.00
6	1.02	0.99	0.00	0.00
7	1.00	0.26	0.83	0.00
8	2.38	0.67	0.00	0.00
9	1.13	1.93	0.00	0.00
10	1.19	1.09	0.89	0.00
11	4.29	0.26	0.06	0.00
12	3.52	1.14	0.06	0.00
13	2.15	2.13	0.35	0.00

The annual number of axle loads  $NA_{ka}$  for vehicle class and axle type are further classified into eight traffic load categories using Table 6.1. Table 6.4 lists some typical characteristics for the axle types in each traffic load category. The annual number of axle load repetitions for each category are distributed into load intervals for each load category following a default axle load distribution of each category that was prepared using traffic data from the LTPP, as shown in Table 6.5. The interval numbers from 1 to 38 on the left-hand side of Table 6.5 represent different load intervals according to load category. The initial loads and load intervals for all eight traffic load categories are indicated in the bottom of Table 6.5. Finally, based on AADTT and calculations mentioned above, the number of axle load repetitions within corresponding load intervals are calculated according to the axle load distribution provided in Table 6.5.

**Table 6.4. Typical Characteristics for Axle Types in Each Traffic Category (58).**

Category	Axle type	Tire type	Tire width (in.)	Tire pressure (psi)	Axle load interval (lb)
1	Single	Single	7.874	40 (<6,000 lb)	3,000 ~ 40,000 lb at 1,000 lb intervals
2		Dual	8.740	120 (>6,000 lb)	
3	Tandem	Single	7.874	120	6,000 ~ 80,000 lb at 2,000 lb intervals
4		Dual	8.740	120	
5	Tridem	Single	7.874	120	12,000 ~ 102,000 lb at 3,000 lb intervals
6		Dual	8.740	120	
7	Quadrem	Single	7.874	120	12,000 ~ 102,000 lb at 3,000 lb intervals
8		Dual	8.740	120	



**Table 6.5. Default Cumulative Axle Load Distribution versus Load Intervals for Each Traffic Category (57).**

Interval No.	Category							
	1	2	3	4	5	6	7	8
1	0.132	0.0896	0.0971	0.0269	0.5835	0.0754	0.4005	0.0056
2	0.2541	0.1941	0.1654	0.0596	0.7411	0.1318	0.5384	0.0187
3	0.3958	0.3282	0.2494	0.1109	0.8465	0.2044	0.6578	0.0472
4	0.5341	0.4689	0.3424	0.1799	0.9115	0.2882	0.7532	0.0962
5	0.6542	0.5977	0.4373	0.2624	0.9498	0.3772	0.8255	0.166
6	0.7505	0.7048	0.5281	0.3522	0.9718	0.4658	0.8783	0.2523
7	0.8235	0.7884	0.611	0.4431	0.9842	0.5496	0.916	0.3478
8	0.8769	0.8508	0.6837	0.53	0.9912	0.6256	0.9423	0.4449
9	0.9149	0.896	0.7457	0.6094	0.9951	0.6924	0.9606	0.5373
10	0.9416	0.9281	0.7973	0.6796	0.9973	0.7497	0.9732	0.621
11	0.9601	0.9505	0.8396	0.7398	0.9985	0.7979	0.9818	0.694
12	0.9728	0.9661	0.8738	0.7905	0.9992	0.8379	0.9876	0.7557
13	0.9815	0.9768	0.9011	0.8325	0.9995	0.8706	0.9916	0.8067
14	0.9875	0.9842	0.9228	0.8668	0.9997	0.8971	0.9943	0.8481
15	0.9915	0.9892	0.9399	0.8945	0.9999	0.9184	0.9962	0.8813
16	0.9942	0.9927	0.9533	0.9167	0.9999	0.9355	0.9974	0.9076
17	0.9961	0.995	0.9637	0.9344	1	0.9491	0.9982	0.9284
18	0.9974	0.9966	0.9719	0.9484	1	0.9599	0.9988	0.9446
19	0.9982	0.9977	0.9782	0.9596	1	0.9684	0.9992	0.9572
20	0.9988	0.9984	0.9832	0.9683	1	0.9752	0.9995	0.967
21	0.9992	0.9989	0.987	0.9752	1	0.9805	0.9996	0.9746
22	0.9994	0.9993	0.9899	0.9806	1	0.9847	0.9997	0.9805
23	0.9996	0.9995	0.9922	0.9848	1	0.988	0.9998	0.985
24	0.9997	0.9997	0.994	0.9882	1	0.9906	0.9999	0.9885
25	0.9998	0.9998	0.9954	0.9907	1	0.9926	0.9999	0.9911
26	0.9999	0.9998	0.9964	0.9928	1	0.9942	0.9999	0.9932
27	0.9999	0.9999	0.9972	0.9944	1	0.9954	1	0.9948
28	0.9999	0.9999	0.9979	0.9956	1	0.9964	1	0.996
29	1	1	0.9984	0.9966	1	0.9972	1	0.9969
30	1	1	0.9987	0.9973	1	0.9978	1	0.9976
31	1	1	0.999	0.9979	1	0.9983	1	0.9982
32	1	1	0.9992	0.9984	1	0.9987	1	0.9986
33	1	1	0.9994	0.9987	1	0.9989	1	0.9989
34	1	1	0.9995	0.999	1	0.9992	1	0.9992
35	-	-	0.9997	0.9992	1	0.9994	1	0.9994
36	-	-	0.9997	0.9994	1	0.9995	1	0.9995
37	-	-	0.9998	0.9995	1	1	1	1
38	-	-	1	1	-	-	-	-
<b>Axle type</b>	Single		Tandem		Tridem		Quadrem	
<b>Tire type</b>	Single	Dual	Single	Dual	Single	Dual	Single	Dual
<b>Interval No. 1~38 indication</b>	From 3,000-lb, 1,000-lb interval		From 6,000-lb, 2,000-lb interval		From 300-lb, 3,000-lb interval		From 12,000-lb, 3,000-lb interval	

**COST OF INSTALLATION OF PAVEMENT MARKING**

Pavement markings play a key role in the driver’s understanding of the roadway and his or her ability to stay on course (59). By helping the driver stay on course, pavement markings reduce the risk of accidents. Pavement markings need to be visible during the day and at night, when

visibility may be more critical due to the reduction in other cues to aid the driver in navigating the roadway (60). Properly maintained pavement markings can potentially reduce crashes that occur at night (mainly run-off-the-road and head-on crashes), especially in areas where the roadway alignment changes (61).

Agencies have limited guidelines to suggest the type of pavement marking material to be used. Thus, the decision of what material to use is often dictated by the initial cost. This approach to pavement marking can result in a lack of durability, poor retro-reflectivity, increased long-term costs, and increased exposure to traffic for the maintenance crews. A 1992 benefit-cost analysis conducted by Miller (62) determined that longitudinal pavement markings (edge lines, centerlines, and lane lines) were cost effective on all roadway types. Miller concluded that nationally, pavement striping has a benefit-cost ratio of 60:1, which, on average, is a \$19,226 benefit over 1 mi. Miller also concluded that in climates where thermoplastic markings are practical, their long life makes their life cycle cost competitive with painted markings.

By using his formula, Miller determined that annual costs for applying paint materials are:

- \$381 per mile for rural interstate striping.
- \$192 per mile for other rural roads.
- \$762 per mile for urban freeways and major urban arterials.
- \$385 per mile for other urban roads.

In addition, the annual costs for using thermoplastic marking materials are approximately:

- \$308 per mile for rural roads.
- \$391 per mile for urban roads.

According to a study conducted by Pike and Bommanayakanahalli (60), the costs associated with the markings can be classified as follows:

- Primary Costs.
  - Material and Construction Costs.
  - Grooving Costs (when grooving is performed).
  - Special Requirements (when there is need for wet retro requirements, warranty, etc.).
  - Marking Removal Costs (when removal is done before applying the new markings).
- Secondary Costs.
  - Administrative Costs.
  - Agency Costs.

- Societal Costs.
  - Delay Costs.
  - Crash Costs.

Two important components need to be evaluated when deciding which pavement marking material to use. The first component is the line or the marking that is put on the pavement; it is visible during the day. The second component, the retro-reflectivity, is the part visible at night when headlights reflect off of the line. Both components are necessary for the marking to be useful to drivers. Typically, beads are dropped on top of the material that is used to make the line to give the marking its retro-reflectivity. Table 6.6 illustrates a matrix of pavement materials and their corresponding installation costs and life cycle based on a study in Minnesota (59).

**Table 6.6. Matrix of Material and Costs and Life Cycle (59).**

<b>Material</b>	<b>Estimated Cost Per Linear Foot<sup>1</sup></b>	<b>Estimated Life of the Material<sup>2</sup></b>
Latex	\$0.03 to \$0.05	9–36 months
Alkyd—new formula	\$0.03 to \$0.05	9–36 months
Mid-durable paint	\$0.08 to \$0.10	9–36 months
Epoxy	\$0.20 to \$0.30	4 years
Tape	\$1.50 to \$2.65	4–8 years

<sup>1</sup> Price estimates are for a minimum of 20,000 linear ft.

<sup>2</sup> Life of pavement marking material will depend on road volumes and local climate.

Another study (63) by the Virginia Transportation Research Council found a wide range in costs for the installation of pavement markings. The cost is primarily influenced by material used and the size of the job. Table 6.7 illustrates the cost of pavement marking for various marking material based on the facility and also on the size of the job. As seen in the table, the costs for two-lane roads are highest because they are based on four continuous lines. The number of passes, i.e., the number of trips the marking truck makes through the road section to complete the marking installation, was based on actual marking practices. Three passes were used on two- and six-lane roads to minimize tracking of the markings, and two passes were used on four-lane roads. For example, on a two-lane road, one pass is made for each edgeline and the centerlines to minimize the vehicles crossing the pavement markings before they are dry.

**Table 6.7. Cost of Installation (\$mi/yr) (63).**

Material	2-Lane Road	2 Lanes on a 4-Lane Divided Highway	3 Lanes on a 6-Lane Divided Highway
Paint (large contract)	840	472	524
Paint (agency install)	1680	944	1048
Paint (small contract)	2450	1770	1965
Thermoplastic	2800	1377	1528
Epoxy	3150	1573	1747
Polyurea	4900	2753	3057
Waffle tape	6300	3540	3930

### **PAVEMENT MARKINGS FOR AV-CV USERS**

Properly installed and well-maintained road markings provide guidance for motorists, pedestrians, and cyclists (64). While well-marked and maintained pavement markings are essential for current operations, they become more critical for AVs using machine vision. Pavement markings serve a critical need in the progression of automated vehicles through the five levels of automation described by SAE and USDOT. Since it is expected that the complex nature of roadways will delay the deployment of full Level 5 automation for many decades to come, future roadway agencies will likely continue to maintain roadways for a mix of human, machine, and fully automated systems for the near future. In this shared environment, markings will likely increase rather than decrease in importance.

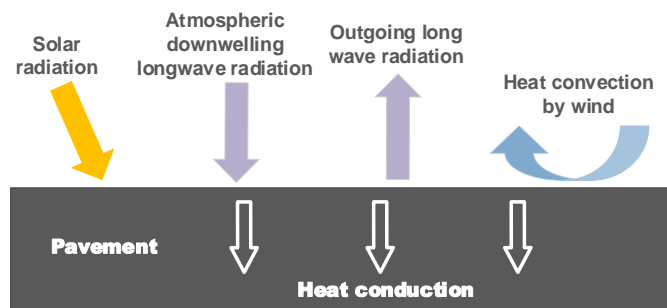
Automotive OEMs provided some recommendations to National Committee on Uniform Traffic Control Devices (NCUTCD) on enhancing pavement markings to facilitate cooperative automated transportation and to benefit machine vision. These improvements included the following (65):

- Pavement marking width—developing uniform width of longitudinal markings.
- Skip line/gap dimensions—establishing uniform dimensions for skip line length and gap spacing.
- Dotted edge line extensions—use of dotted edge line extensions along ramps.
- Hatched markings inside gore areas—use of hatching (chevron markings) inside gores.
- Contrast markings used on concrete roadways.

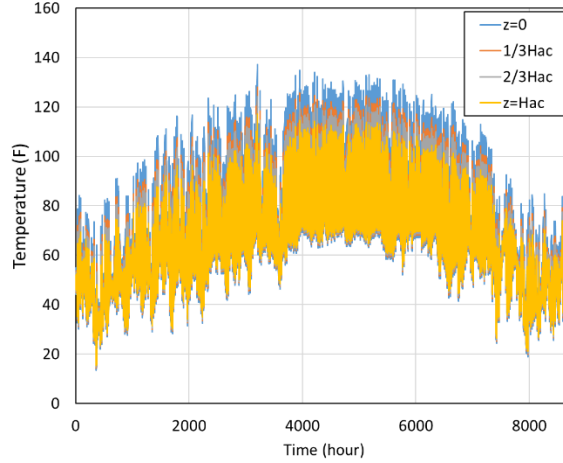
## CLIMATE MODEL

### Temperature Prediction in Surface Layer

The mechanical properties of bituminous material are significantly influenced by seasonal variations in temperature and climatic conditions. Accurate prediction of climatic conditions results in increased accuracy in predicting pavement performance. To evaluate the seasonal variations in climatic conditions associated with individual pavement sections and characteristics, the one-dimensional heat transfer model (66) was adopted to calculate temperature levels at different depths in the surface layer. On the pavement surface, the model comprehensively considers heat sources, including solar radiation, atmospheric down-welling, and outgoing longwave radiation and convection enhanced by wind, as shown in Figure 6.4. The thermal properties of the layer materials are used to predict heat transfer in the pavement through conduction. Figure 6.5 shows the calculated annual temperature profiles of Texas Section 48-1056 at different depths using the enhanced integrated climatic model based on the measurements collected from the nearby climate station. Pavement temperature gradients across different pavement layers' cross-sectional thicknesses can be observed in Figure 6.5, with higher pavement surface temperature in the summer than the predicted temperature at the bottom of the pavement. The temperature gradient influences the properties of the asphalt mixtures, which can result in significant variations in the predicted distress in the pavement section. The pavement temperatures profiles of all Texas pavement sections considered in this analysis are estimated using the individual pavement geographical location data.



**Figure 6.4. Illustration of Heat Transfer Model of Asphalt Pavement.**



Note: Hac = thickness of asphalt mixture layer.

**Figure 6.5. Annual Temperature Profiles of Texas Section 48-1056 at Different Depths.**

### Suction

Suction at a certain depth in the subgrade layer reaches an equilibrium condition several years after construction of pavement structures. The magnitude of equilibrium suction has a major effect on the resilient modulus of base/subgrade soil. Lytton (71) developed a model for predicting the resilient modulus of base and subgrade layers considering the moisture and suction in unbound granular materials. The consideration of the matric suction is important for the accurate prediction of the resilient modulus of base, subbase, and subgrade layers. Saha (72) proposed a mechanistic-empirical model to predict equilibrium suction that considered the effects of physical properties of the soil and climatic factors. The model proposed by Saha (72) is used for the estimation of the suction in the unbound granular layers.

According to Saha (72), the equilibrium volumetric water content at the depth of moisture active zone  $\theta_e$  is calculated from the following equation:

$$\frac{\theta'_{dry} - \theta_{dry}}{\sqrt{\frac{n\pi}{\alpha}}} (1 - e^{-\sqrt{\frac{n\pi}{\alpha}} Z_m}) + [(\theta_e - \theta'_{dry})] Z_m = d_m \quad (6.4)$$

where  $\theta'_{dry}$  denotes the volumetric water content at the depth of  $Z_m$  under a dry air state;  $Z_m$  is the depth of the moisture active zone;  $\theta_{dry}$  is the volumetric water content at the surface under a dry air state, with a corresponding suction of pF = 5.7 for vegetation areas and pF = 3 for non-vegetation areas;  $d_m$  is mean annual moisture depth;  $\alpha$  is the unsaturated diffusivity coefficient determined as a function of the slope of the soil-water-characteristics curve and saturated soil-water permeability;  $n$  is the number of suction cycles per second; and  $\theta_e$  is the

equilibrium volumetric water content at the depth of  $Z_m$ . More details about the suction model and these parameters; calculations can be found in Saha (72).

The relationship between matric suction and water content is characterized by the Fredlund–Xing equation below. Using the following equations, we can solve for soil matric suction  $h_m$  given volumetric water content and vice versa:

$$S = C(h) \left[ 1 / \left\{ \ln \left[ e + \left( \frac{h_m}{a_f} \right)^{b_f} \right] \right\} \right]^{c_f} \quad (6.5)$$

$$C(h) = 1 - \frac{\ln(1 + h_m / h_r)}{\ln(1 + 1.45 \times 10^5 / h_r)} \quad (6.6)$$

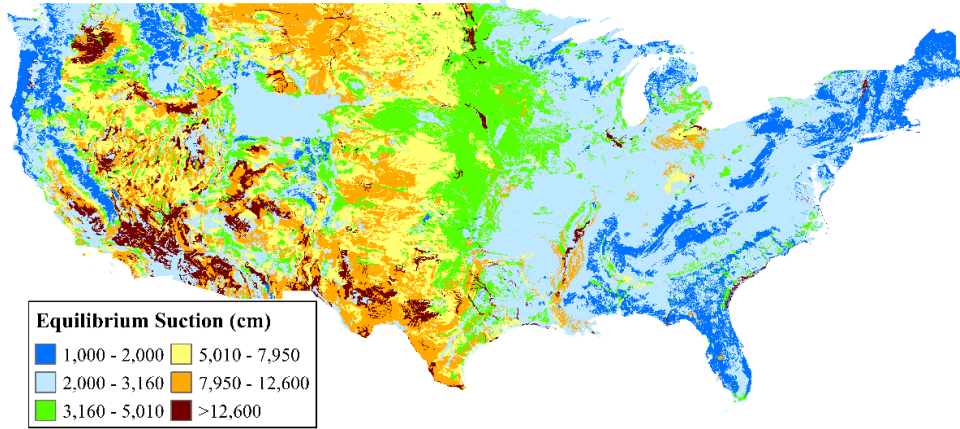
$$S = \frac{\theta}{\theta_{sat}} \quad (6.7)$$

where  $C(h)$  is the correction factor;  $S$  is the degree of saturation;  $h_m$  is the soil matric suction; and  $a_f$ ,  $b_f$ ,  $c_f$ , and  $h_r$  are fitting parameters obtained from the output of the ANN model developed by Saha et al. (73). The input and output parameters of the ANN model are summarized in Table 6.8.

The equilibrium suctions for different geographical locations in the United States were calculated using the approach mentioned above, and the database was used to generate a contour map in ArcGIS, as shown in Figure 6.6. The procedure for obtaining volumetric content of each unbound base/subbase layer is as follows:

- Collect geographic coordinates (latitude and longitude) of each LTPP section in Texas.
- Input the geographic coordinates into the ArcGIS program to obtain the equilibrium suction of the corresponding section and its depth of moisture active zone.
- Collect pavement layer information of all the selected sections in Texas and calculate the soil suction at the middle of each layer through linear interpolation.
- Collect data of soil properties for each layer as an input of the Soil Water Characteristic Curve (SWCC) ANN model; the parameters of Fredlund–Xing equation are obtained by the output of ANN.
- Substitute the soil suction of each layer into the Fredlund–Xing equation, which then yields the volumetric water content of each layer in each LTPP section.

The obtained volumetric water content and soil suction of each pavement layer in each selected LTPP section in Texas are used as input parameters to calculate the resilient modulus of the unbound granular layers.



**Figure 6.6. GIS-Based Contour Map of Equilibrium Suction.**

**Table 6.8. List of Input and Output Parameters of SWCC ANN.**

Input parameters						Output parameters			
Passing #4 sieve	Passing #200 sieve	LL	PI	$\theta_{sat}$	MAAT ( $^{\circ}C$ )	$a_f$ (cm)	$b_f$	$c_f$	$h_r$ (cm)

Note: LL = live load; PI = plastic index. MAAT = Mean Annual Air Temperature

## MATERIAL PROPERTY PREDICTION SUBMODELS

### Asphalt Concrete Stiffness Aging Model Using Artificial Neural Network Algorithm

The dynamic modulus is one of the most important material properties required to estimate pavement response in order to predict pavement performance. The Artificial Neural Networks (ANN) 1999 model developed by Ceylan et al. (74) is used for the prediction of the dynamic modulus of the asphalt mixtures used in Texas pavement sections. Ceylan et al. (74) developed an ANN prediction model using a database containing 7,400 data points from 346 mixtures. The input parameters required for the ANN 1999 model are the volumetric composition and the gradation of mixture, viscosity, and loading frequency, as shown in in Table 6.9. Aging of the asphalt mixture due to exposure to oxygen results in the oxidative aging of the mixture over time. The effect of aging on the hardening property of the asphalt binder is captured using the aging model developed by Zhang et al. (75) to calculate the aged viscosity  $\eta_t$  as an input to the ANN dynamic modulus model.



**Table 6.9. Input Parameters for 1999 Dynamic Modulus ANN Predictive Model.**

Input						Output			
Gradation				Volumetric		Binder data		Dynamic modulus	$R^2$
3/4%	3/8%	#4%	#200%	$V_a$ %	$V_{beff}$ %	$\eta$ %	$f_c$ %	$ E^* $ psi	0.98

### Moisture-Dependent Resilient Modulus of Base and Subgrade

Resilient modulus is another fundamental material property in pavement design and analysis. It is defined as the ratio of repeated cyclic loading divided by recoverable strain, which describes the response of pavement to dynamic loading.

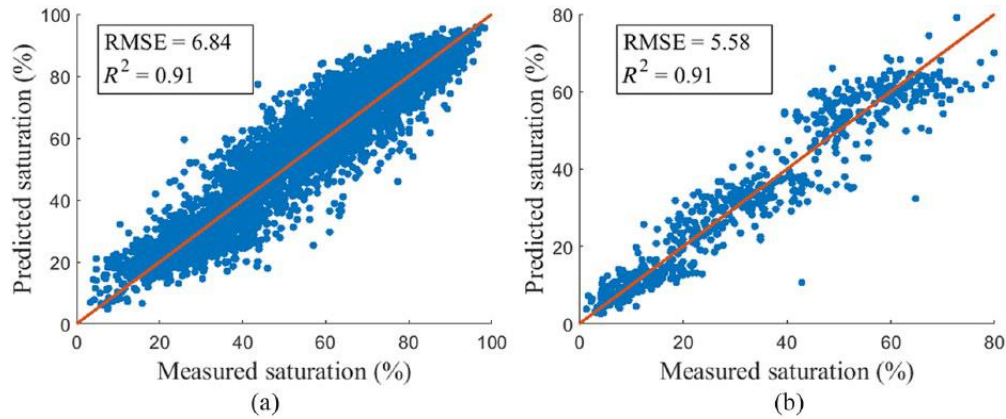
Previous studies (67–70) demonstrated that both stress and moisture play an important role in influencing the resilient modulus of base and subgrade soil. In addition, the combined effect of the degree of saturation and soil suction needs to be considered to estimate the variation of the resilient modulus. Therefore, Lytton’s resilient modulus model (71), which considers the abovementioned conditions, was adopted in this study and is represented as:

$$M_R = k_1 P_a \left( \frac{I_1 - 3\theta f h_m}{P_a} \right)^{k_2} \left( \frac{\tau_{oct}}{P_a} \right)^{k_3} \quad (6.8)$$

$$f = 1 + \frac{S - 85}{15} \left( \frac{1}{\theta} - 1 \right) \quad (6.9)$$

where  $I_1$  is first invariant of the stress tensor;  $P_a$  is atmospheric pressure;  $\theta$  is volumetric water content;  $h_m$  is matric suction in base/subgrade;  $f$  is saturation factor,  $1 < f < 1/\theta$ ;  $\tau_{oct}$  is octahedral shear stress;  $k_1$ ,  $k_2$ , and  $k_3$  are regression coefficients; and  $S$  is degree of saturation.

As mentioned before, soil suction and volumetric water content are obtained using the approach elaborated on in the previous section. Here, three regression coefficients— $k_1$ ,  $k_2$ , and  $k_3$ —are predicted using the ANN model developed by Saha et al. (73). Figure 6.7 shows the measured and predicted degree of saturation for plastic and non-plastic soils, respectively. It can be seen that the prediction from ANN agrees well with the observations, with a  $R^2$  value of 0.91. The inputs of the resilient modulus ANN prediction model include percent of material passing a 3/8-inch sieve, percent of material passing a No. 200 sieve, plastic limit (PL), plastic index (PI), optimum moisture content (OMC), maximum dry density (MDD), and tested moisture content (TMC) for plastic soil. For non-plastic soil, the input variables include percent of material passing the No. 200 sieve, gradation scale parameter  $\theta$ , shape parameter  $\Psi$ , OMC, MDD, and TMC, as shown in Table 6.10. The calculation results of base/subgrade resilient moduli for all the selected LTPP sections in Texas are shown in Table 6.11.



**Figure 6.7. Comparison of Measured versus Predicted Saturation (%) at 0.1-bar, 0.33-bar, and 15-bar Suction Level for Unbound Granular Base Materials Using the ANN Model: (a) Plastic Soils; (b) Non-plastic Soils (73).**

**Table 6.10. Input Parameters for Resilient Modulus ANN Predictive Model (73).**

Soil type	Input							Output		
Plastic	%passing 3/8	%passing 200	PL	PI	OMC	MDD	MC	$k_1$	$k_2$	$k_3$
Non-plastic	%passing 3/8	%passing 200	Scale parameter $\theta$	Shape parameter $\Psi$	OMC	MDD	MC	$k_1$	$k_2$	$k_3$

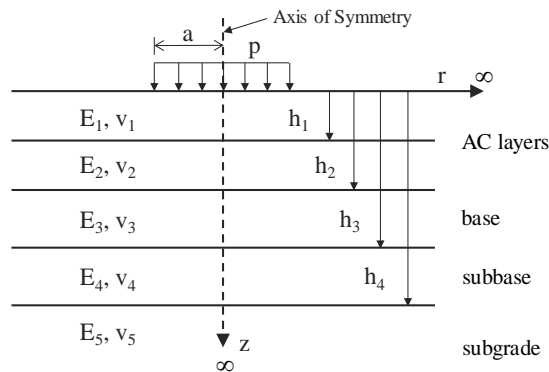
**Table 6.11. Resilient Moduli of Base and Subgrade Layers for Selected LTPP Sections in Texas Calculated by SWCC and Resilient Modulus ANN Models.**

SHRP-ID	Base resilient modulus (MPa)	Subgrade resilient modulus (MPa)	SHRP-ID	Base resilient modulus (MPa)	Subgrade resilient modulus (MPa)
1039	127.61	55.24	1174	251.28	87.37
1048	190.87	61.56	1178	222.54	108.67
1050	242.77	134.10	1183	185.03	68.06
1056	173.55	76.94	3689	89.87	137.78
1061	217.96	155.37	3729	78.51	46.30
1076	660.24	126.58	3749	104.45	40.80
1087	191.47	98.91	3875	190.37	48.62
1111	185.15	58.97	6079	143.54	62.44
1116	137.75	44.02	6086	125.52	159.67
1119	186.91	33.27	6160	152.80	110.77
1130	267.32	39.94	6179	122.03	48.03

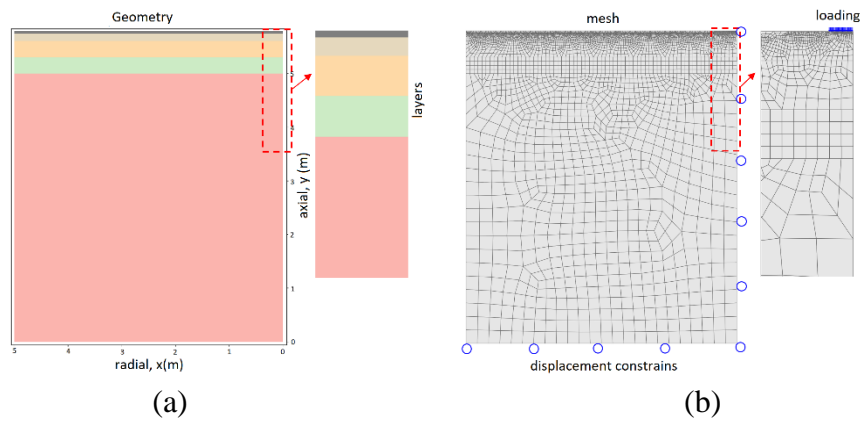
## PAVEMENT RESPONSE SUBMODEL

The pavement response submodel calculates the pavement response due to prescribed traffic loading. The pavement response submodel employs a finite element model (FEM) to compute and visualize the responses of the pavement system, including stresses, strains, displacements,

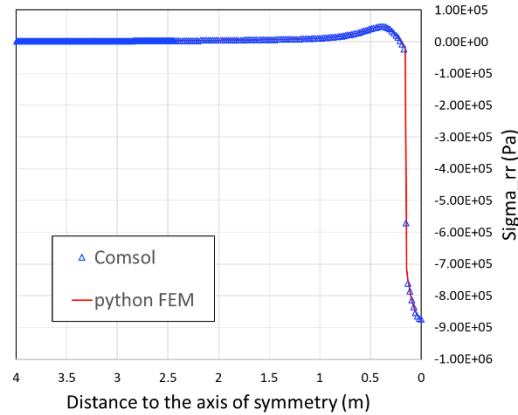
and reaction forces at any location of the system. The FEM submodel uses the Python 3 library and Calculix as the core solver. Figure 6.8 shows a typical layout of a pavement structure. The geometry, mesh scheme, loading, and displacement constraints of a typical layered system is shown in Figure 6.9. To verify the accuracy of the present FEM model,  $\sigma_r$  at the asphalt concrete surface is calculated using the present FEM submodel and compared with the results obtained by the commercial software COMSOL, shown in Figure 6.10. The stiffness gradient in the asphalt concrete (AC) layer as well as the moisture- and stress-dependent resilient modulus of the unbound granular materials are considered in the analysis.



**Figure 6.8. Pavement Structure in the Proposed Pavement Response Model.**



**Figure 6.9. Finite Element Configuration of Layered System: (a) Geometry; (b) Mesh and Loading.**



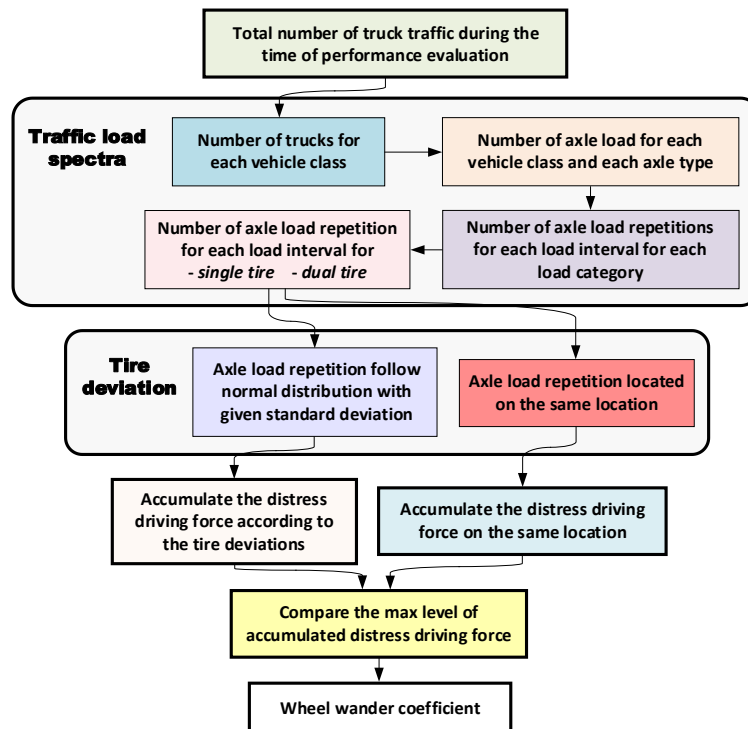
**Figure 6.10. Comparison of Pavement Surface Radial Stresses  $\sigma_{rr}$  Using Python FEM Simulator and COMSOL Software.**

### **EFFECTS OF WHEEL WANDER**

Automation truck systems are designed to follow a more precise path on the center of road compared to traditional trucks. Such platooning operations may accelerate the accumulation of pavement distress when compared to traditional trucks with natural lateral wheel wander (WW). In this section, the modeling approach for the consideration of traffic loads with and without wander in the prediction of pavement performance is presented. The variability of the lateral WW was modeled with a normal distribution and a standard deviation of 10 inches (25.4 cm) (56). Based on lateral WW, each axle load varies in magnitude within certain load intervals that follow the axle load distribution. Therefore, depending on the objectives of analysis, the WW effect is investigated specifically based on the driving force responsible for different pavement distress types at the location where the distress is likely to occur. For example, fatigue cracking is analyzed in the pavement ME design based on the horizontal strain at the bottom of the AC layer. The WW effects for fatigue cracking are captured by comparing the horizontal strain at the AC bottom under the tire path for wander and no wander conditions. Since the pavement sections exhibit different design attributes, including variation in (a) the dynamic modulus of AC layers, (b) the resilient modulus of unbound layers, and (c) geographical climate conditions, the analysis is performed for the individual sections to capture the effects of the variations in design attributes on the predicted performance. These effects imply that the resulting WW effect for different distress types, characterized by a parameter termed the WW coefficient, is not a constant parameter for all pavement sections. The summary of the concepts and procedures for the analysis of the pavement performance with or without WW is shown in Figure 6.11, with key factors presented below:

- The variability of the lateral WW is considered using a normal distribution with a standard deviation of 10 inches (25.4 cm).
- The variation of axle load magnitude follows the axle load distribution modeled by the Gompertz model with default parameters.

- Considering the design attributes of the individual pavement sections, the driving forces (e.g., strain energy or horizontal strain, etc.) are calculated using Python FEM and compared for both WW and non-WW cases based on specific pavement distress modes and target locations (pavement surface or bottom, etc.) where the distress most likely occurs.
- Results obtained from the WW and non-WW cases are used to estimate the WW coefficients for individual pavement sections and distress types.



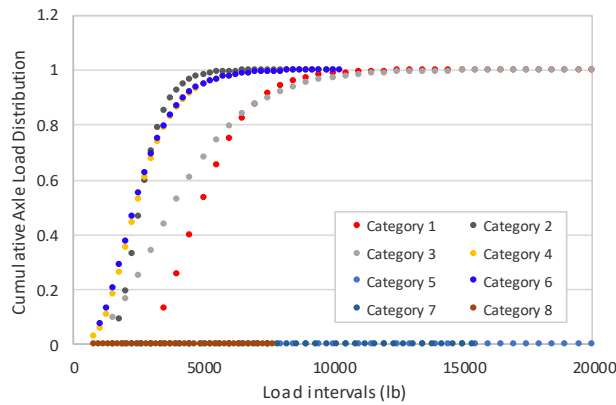
**Figure 6.11. Procedures for Pavement Performance Analysis with or without WW with Variation of Tire Load Magnitude and Deviation.**

### Variabilities of Axle Load on Magnitude

Field observations have shown that the path of travel of passing vehicles along a pavement section is normally distributed and centered about the lane centerline. The standard deviation of the corresponding normal distribution describes the degree of lateral WW, in other words, the spread of wheel location according to the center of the wheel path. In order to consider loading characteristics of the cases of WW and non-WW, a standard deviation of 10 inches (25.4 cm) is assumed for the case of truck traffic with WW, while the standard deviation is set to be zero for the case of autonomous platooned trucks.

Each axle load that deviates from the centerline also varies in magnitude by an axle load distribution described in the traffic data section. Based on the given AADTT, after using the abovementioned calculation processes, the annual number of axle load repetitions within a

specific load interval are obtained using the default CALD for each traffic category. Figure 6.12 shows the accumulative axle load distribution versus load intervals for all categories using default class, axle type, and axle load distribution. As depicted in Table 6.2 and Table 6.3, the typical number of tridem axles for Class 4 and 5 are both zero, which indicates the number of axle loads for Category 5 is zero. Similarly, the number of axle loads for Category 7 and 8 are zero.

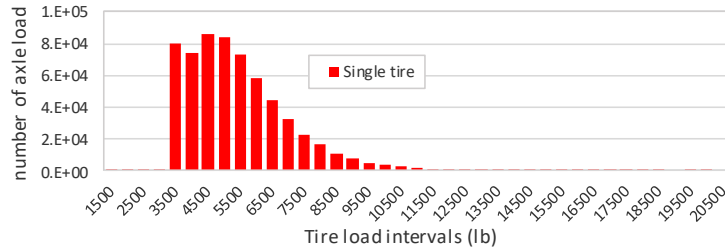


**Figure 6.12. Cumulative Axle Load Distribution versus Load Intervals for All Categories Using Default Class, Axle Type, and Axle Load Distribution.**

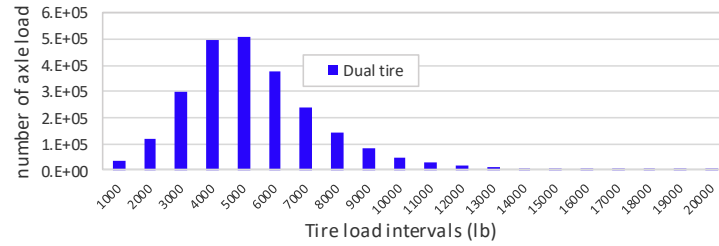
To characterize and quantify WW effects, a large annual truck traffic of  $2 \times 10^6$  is assumed to capture the overall effect of the normally distributed load on both the applied location and magnitude for all pavement sections. Then, the annual number of trucks is extended to the number of axle load repetitions that are allocated for each load interval in each category and tire type. Based on the category definition, the axle of Categories 1, 3, 5, and 7 are of a single tire type, while the axle of Categories 2, 4, 6, and 8 are of dual tire type. For simplicity's sake, the axle load of all eight categories are further divided into two groups that are single and dual tire type by merging the same tire type and same load intervals together. According to the number of tires per axle, the tire load is calculated from the following:

$$\text{Tire load (lb)} = \frac{\text{Axle load (lb)}}{\text{Number of tires}} \quad (6.10)$$

The annual truck traffic of  $2 \times 10^6$  is eventually categorized into the number of tire load repetitions for single and dual tire types, respectively. Figure 6.13 shows the calculated number of axle load repetitions on load intervals for single and dual tire types based on annual truck traffic.



(a)

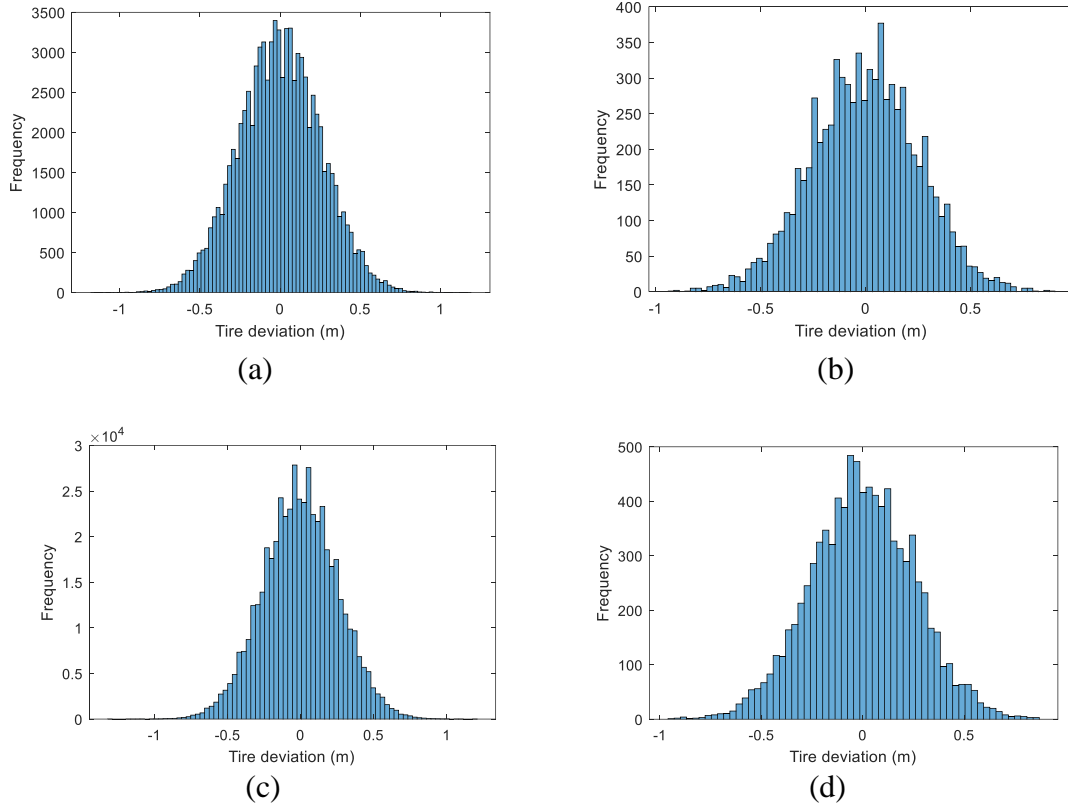


(b)

**Figure 6.13. Number of Axle Load Repetitions versus Load Intervals Based on Annual Truck Traffic of  $1 \times 10^6$  for (a) Single and (b) Dual Tire Type.**

### Variabilities of Tire Load on Location

The variability of tire load position follows a normal distribution, with a standard deviation of 25.4 cm in this study. The researchers assumed that the tire loading position in each tire load interval follows the same normal distribution comparable to other load intervals. Figure 6.14 shows the examples of distributions of the tire loads in a tire load interval. In a tire load interval of 5,000 lb and 9,000 lb within a single tire category, according to load repetitions shown in Figure 6.13, the number of tire loads are 86,123, and 7,761, and their distributions are shown in Figure 6.14(a) and (b), respectively. For 5,000 lb and 13,000 lb in the dual tire category, the number of tire loads are 508,898 and 9,153, and their distributions are shown in Figure 6.14(c) and (d), respectively.

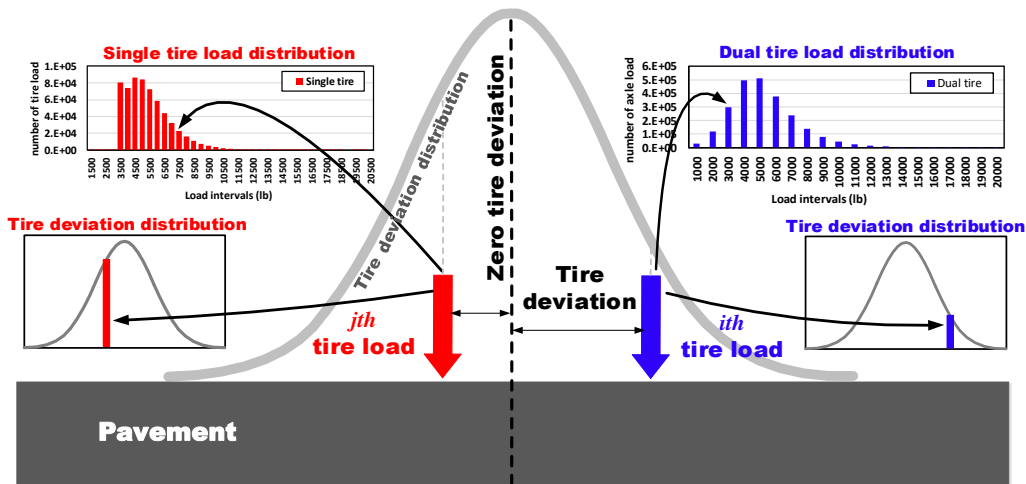


**Figure 6.14. Tire Deviation Distributions for (a) 5,000-lb Tire Load Interval with 86,123 Load Repetitions in Single Tire Category; (b) 9,000-lb Tire Load Interval with 7,761 Load Repetitions in Single Tire Category; (c) 5,000-lb Tire Load Interval with 508,898 Load Repetitions in Dual Tire Category; (d) 13,000-lb Tire Load Interval with 9,153 Load Repetitions in Dual Tire Category.**

### **Wheel-Wander Effects on Cumulative Driving Force of Pavement Distress**

After acquiring both position and magnitude distributions of tire load, along with the material properties for each layer of pavement, each tire load is applied to the pavement structure using the FEM model to calculate the accumulative driving force depending on the target type of pavement distress. For top-down cracking (TDC) analysis, the WW coefficient is calculated based on the accumulated stress profile at the pavement surface. According to the *Pavement ME Design Guide*, the horizontal strain at the bottom of the asphalt layer is the driving force for fatigue cracking analysis; therefore, the cumulated strain profile on the bottom of the AC layer is adopted to obtain the WW effect.

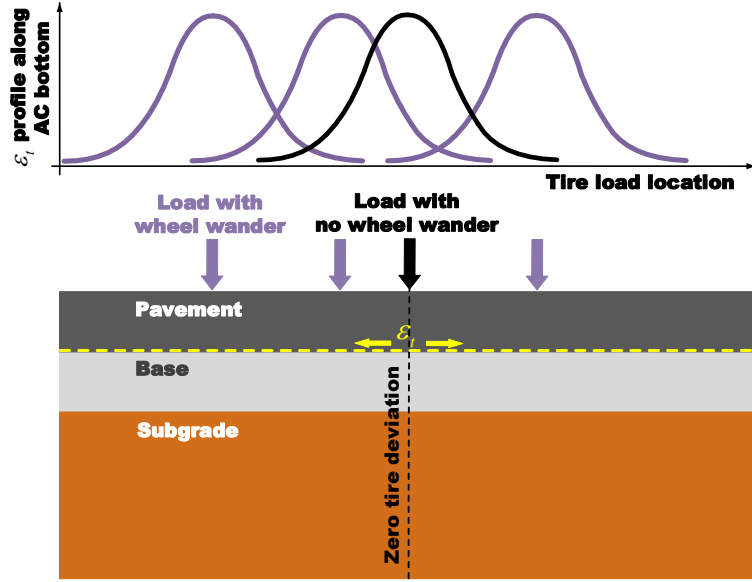




**Figure 6.15. Illustration of Variation of Each Tire Load on Magnitude and Deviation.**

In the following description, the horizontal strain at bottom of the AC layer is taken as an example of distress driving force. Figure 6.15 illustrates the variation of each tire load on magnitude and deviation. The  $i$ th tire load (blue arrow) is one of 298,570 tire load repetitions in a 3,000-lb interval, as shown in the dual tire load distribution in the right corner of Figure 6.15. It also follows the tire deviation distribution shown in the gray curve and has a possibility to apply on the present location accordingly. The other tire load, the  $j$ th tire load (red arrow) for example, follows the same tire deviation distribution, but is one of 23,131 tire load repetitions in a 7,500-lb interval, as shown in the single tire load distribution in the left corner of Figure 6.15.

The strain profiles  $\varepsilon(x)$  at the bottom of the AC layer induced by each tire load—with and without wheel lateral wander cases—are both recorded, which are shown as purple and black curves at the top of Figure 6.16. In this case, the distributions of tire load magnitude are the same for WW and non-WW cases. The only difference between WW and non-WW cases is tire deviation. Further, the strain profiles are respectively summed up using the superposition principle for both cases. Figure 6.17 shows a typical superimposed strain profile for WW (purple curve) and non-WW (gray curve) cases.



**Figure 6.16. The Driving Force Profiles (tensile strain at AC bottom) Induced by Each Tire Load with (purple curves) and without (black curve) WW.**

For the WW case, the strain profile caused by a specific tire load is written as  $\varepsilon_{ijk}(x)$ . The subscript  $i$  equals to 1 or 2,  $i = 1, 2$ , indicating the single and dual tire load type, respectively. The subscript  $j$  indicates the  $j$ th tire load interval shown as the horizontal axle in Figure 6.13. The subscript  $k$  equals the  $k$ th tire load, which is one of the total number of tire loads in the  $j$ th tire load interval. Taken together, the superimposed WW strain profile is calculated as:

$$E_{WW}(x) = \sum_{i=1}^2 \sum_{j=1}^{J_i} \sum_{k=1}^{K_{ij}} \varepsilon_{ijk}(x) \quad (6.11)$$

where  $J_i$  is total number of tire load interval for  $i$ th tire type,  $K_{ij}$  is the number of tire repetitions in  $j$ th tire load interval for  $i$ th tire type.

For non-WW cases, the loading positions are identical for all tire loads that are applied on the mean position of the loads in WW cases. The induced strain profile is written as  $\varepsilon_{ij}(x)$ .

Therefore, the superimposed strain profile for non-WW cases is calculated as:

$$E_{nonWW}(x) = \sum_{i=1}^2 \sum_{j=1}^{J_i} \sum_{k=1}^{K_j} \varepsilon_{ij}(x) \quad (6.12)$$

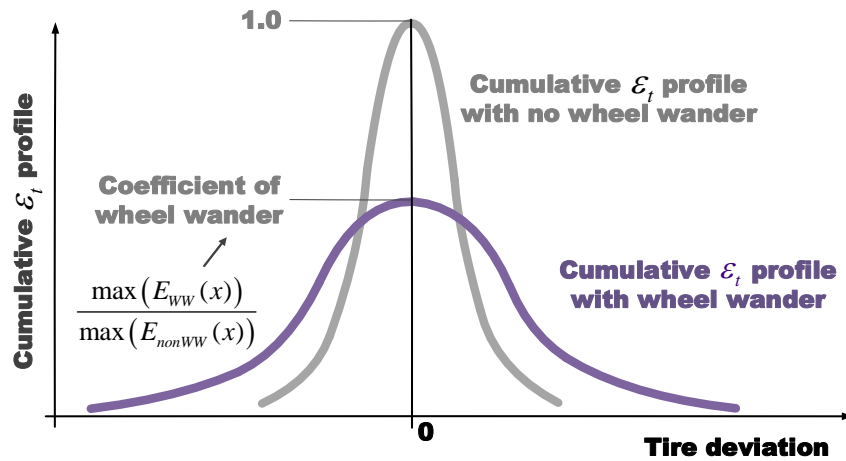
The WW effect is quantified as a WW coefficient  $C_{WW}$  by comparing the maximum levels of distress driving force for the cases with and without WW:

$$C_{WW} = \frac{\max(E_{WW}(x))}{\max(E_{nonWW}(x))} \quad (6.13)$$

The load position is usually fixed in pavement performance analysis. Typical accumulated distress driving force is shown as the gray curve in Figure 6.15. By multiplying the WW coefficient  $C_{WW}$  to  $\max(E_{nonWW}(x))$ , the maximum levels of distress driving force of a non-WW case is brought to the same level as the WW case:

$$\max(E_{WW}(x)) = C_{WW} \max(E_{nonWW}(x)) \quad (6.14)$$

Thus, the WW case can be modeled by a fixed load position simulation using the WW coefficient  $C_{WW}$ .



**Figure 6.17. Accumulative Driving Force Profiles ( $\varepsilon_t$  at AC bottom) Induced by Annual Tire Load with (purple curve) and without (gray curve) WW.**

### Wheel-Wander Coefficient

Equations (6.13) and (6.14) show a conceptual model of a WW coefficient. In actual analysis scenarios, two type of schemes can capture the WW effects. First, a WW coefficient  $C_{WW}^N$  is multiplied by the total number of tire loads  $N_{total}$ , written as follows:

$$C_{WW}^N N_{total} = \sum_{i=1}^2 \sum_{j=1}^{J_i} C_{WW}^N K_{ij} \quad (6.15)$$

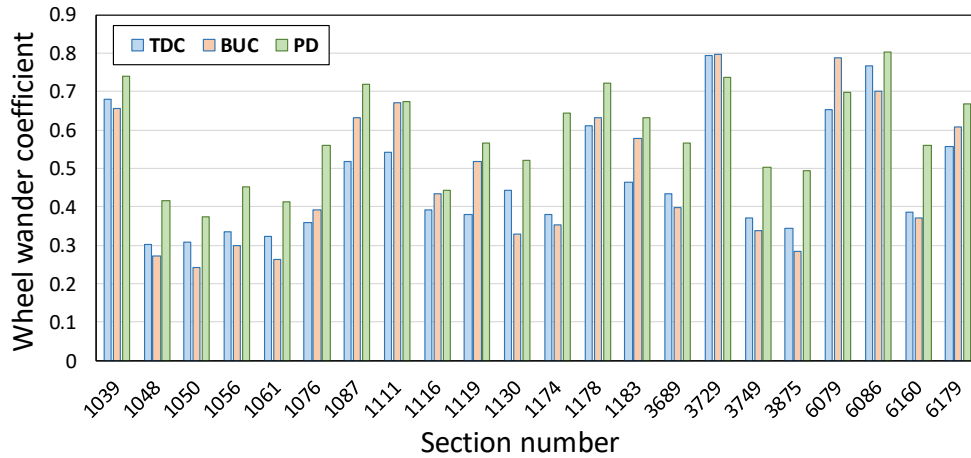
After applying  $C_{WW}^N$  to the number of tire loads, the maximum level of non-WW and WW cases should equal each other. The driving force profile caused by a specific tire load for WW and non-WW cases are written as  $w_{ijk}^{WW}(x, P_k)$  and  $w_{ij}^{nonWW}(x, P_k)$ , respectively. The driving force  $w$

is the function of  $x$  and  $P_k$ , where  $x$  indicates the location, and  $P_k$  is the loading magnitude of the  $k$ th tire load interval. By using the equality function, the WW coefficient on load number  $C_{WW}^N$  can be obtained by solving Equation (6.16).

$$\max \left( \sum_{i=1}^2 \sum_{j=1}^{J_i} \sum_{k=1}^{C_{WW}^N K_j} w_{ij}^{nonWW}(x, P_k) \right) = \max \left( \sum_{i=1}^2 \sum_{j=1}^{J_i} \sum_{k=1}^{K_j} w_{ijk}^{WW}(x, P_k) \right) \quad (6.16)$$

For other distress analysis, like rutting behavior modeling, it is recommended that the WW coefficient be applied on the loading magnitude, which is denoted as  $C_{WW}^L$ . After applying  $C_{WW}^L$  to the load magnitude, the driving force profile caused by a specific tire load for WW and non-WW cases are written as  $w_{ijk}^{WW}(x, P_k)$  and  $w_{ij}^{nonWW}(x, C_{WW}^L P_k)$  respectively. Similar to Equation (6.16), the WW coefficient on load magnitude  $C_{WW}^L$  is calculated by solving the following equation:

$$\max \left( \sum_{i=1}^2 \sum_{j=1}^{J_i} \sum_{k=1}^{K_j} w_{ij}^{nonWW}(x, C_{WW}^L P_k) \right) = \max \left( \sum_{i=1}^2 \sum_{j=1}^{J_i} \sum_{k=1}^{K_j} w_{ijk}^{WW}(x, P_k) \right) \quad (6.17)$$



**Figure 6.18. Wheel-Wander Coefficients for TDC, Bottom-Up Cracking (BUC), and Rutting (PD) for 22 Texas LTPP Sections.**

In the following analyses, the choice of WW coefficients is specified in the results and discussion sections. For the analysis of the WW effects for other pavement distress types, the type and value of WW coefficients were calculated based on specific types of driving force for the distress of interest. Figure 6.18 shows WW coefficients obtained for TDC, BUC, and rutting for 22 Texas LTPP sections, respectively.

## PREDICTIVE MODELS FOR TDC INITIATION AND GROWTH

The development of TDC has two phases—macro-crack initiation and propagation, respectively. The macro-crack initiation can be predicted using the framework (76) developed based on the hot mix asphalt fracture mechanics (HMA FM) by researchers (77, 78). The mechanics-based analysis framework predicts pavement performance for given mixtures, pavement configurations, and traffic conditions based on energy-based parameters. Once the initiation time is determined, the growth of crack is predicted using the pseudo J-integral based Paris's law. To facilitate the implementation of the propagation model, the fracture parameter J-integral at the crack tips is evaluated using the ANN model (81), which was developed based on the J-integral results from the FEM based on different combinations of independent input variables such as layer thicknesses, modulus gradient of AC layer, crack depth, and loading conditions.

### TDC Initiation Time Prediction

The mechanics-based predictive framework presented by (76) is used for TDC initiation time prediction. Based on given pavement information, two energy-based parameters are used for TDC performance, which are the accumulated dissipated creep strain energy ( $DCSE_{accum}$ ) and the dissipated creep strain energy limit ( $DCSE_{lim}$ ), respectively.  $DCSE_{accum}$  represents the induced damage due to traffic loading, while  $DCSE_{lim}$  indicates the mixture resistance to cracking. The limiting state for crack initiation is obtained through continuous comparing of the accumulated and dissipated strain energy densities, which is expressed by:

$$PE(t) = DCSE_{accum}(t) - DCSE_{lim}(t) \quad (6.18)$$

The energy threshold  $DCSE_{lim}$  is the material resistance to macro-crack initiation that decreases with time due to aging effects. Researchers (79, 80) found the correlation between  $DCSE_{lim}$  and primary structure coating thickness  $t_{ps}$  based on indirect tensile test (IDT) data. The evolution of  $DCSE_{lim}$  with respect to aging is predicted using:

$$DCSE_{lim}(t) = k_1 (t_{ps})^{k_2} (t)^{(k_3 + k_4 \cdot \log(t_{ps}))} \quad (6.19)$$

where  $k_1 = 2.38$ ,  $k_2 = -0.79$ ,  $k_3 = -0.33$ , and  $k_4 = 0.12$  are regression coefficients, and  $t$  is age.

Accumulated  $DCSE_{accum}$  accounts for damage development due to applied traffic load, which is calculated by multiplying accumulated driving by surface tensile stress and creep strain rate induced by hourly traffic:

$$DCSE_{accum}(t) = 0.05 \cdot \sum_{t=1}^{nhrs} ESAL(t) \cdot \sigma_{av}^2(t) \cdot \dot{\epsilon}_{pmax}(t) \cdot (1 - h_y(t)) \quad (6.20)$$

where  $\sigma_{av}$  is load-induced horizontal tensile stress on the pavement surface,  $\dot{\epsilon}_{pmax}$  is creep compliance rate,  $ESAL$  is hourly traffic volume, and  $t$  is age. The healing potential,  $h_y$ , captures the healing effects of asphalt mixture using the simplified model presented by (76), which is written as:

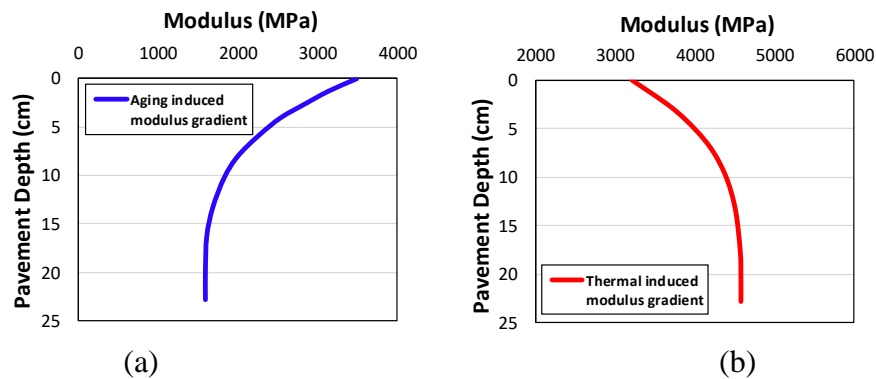
$$h_y(t) = 1 - \left( \left[ \exp\left(\frac{t_{PS}}{t}\right)^{-DCSE_i} \right]_{norm} \right)^k \quad (6.21)$$

where  $DCSE_i$  is the initial value of dissipated creep strain energy and  $t$  is age in years. The healing potential  $h_y(t)$  varies from 1 to 0 and represents the weakening of healing capacity due to aging. The parameter  $k$  serves as a framework calibration parameter that defines the trend of healing potential.

The TDC initiation time is determined when  $DCSE_{accum}$  is equal to or greater than  $DCSE_{lim}$ .

### TDC Growth Prediction Using ANN Model of J-Integral

Long-term aging causes a modulus gradient along the depth of the asphalt layer. The temperature gradient along the surface layer also introduces a thermal-induced modulus gradient in the pavement section. The aging and temperature-induced modulus gradients in a typical asphalt layer are shown in Figure 6.19. Both aging- and temperature-induced modulus gradients were considered in this study.



**Figure 6.19. Modulus Gradient versus Depth of Asphalt Layer Due to (a) Oxidative Aging Effect and (b) Thermal Effect.**

Previous work (81) based on the fracture parameter  $J$ -integral at the crack tips for different crack depths can be used to determine crack growth rate using Paris's law. By using typical pavement material properties with the modulus gradient, pavement structures, and crack depth, a series of

3D FEM simulations were carried out to determine the  $J$ -integral. The crack growth rate for asphalt mixtures is calculated as:

$$\frac{dc}{dN} = A(J)^n \quad (6.22)$$

where  $c$  is crack length,  $N$  is number of load cycles, and  $A$  and  $n$  are fracture coefficients. The  $J$ -integral is calculated as:

$$J = \frac{\frac{\partial DSE}{\partial N}}{\frac{\partial CSA}{\partial N}} \quad (6.23)$$

where  $DSE$  is dissipated strain energy for a fracture and  $CSA$  is the crack surface area.

A multilayer backpropagation ANN was constructed to predict the  $J$ -integral based on the database of  $J$ -integral results from FEM simulations using the commercial program ABAQUS for a wide range of thicknesses of asphalt, base and subgrade, crack locations and depths, modulus gradients of asphalt layer, and elastic modulus of base and subgrade. A crack of 1 m long is assumed, located along the longitudinal direction of pavement. The FEM mesh details and four candidates of crack location are plotted in Figure 6.20.

The FEM model simulated a range of asphalt thickness—from 25 mm to 500 mm—that covered the possible thickness scope of realistic pavements. A crack ratio was used to describe the crack depth, which is the proportion of crack depth to asphalt layer thickness. All other necessary parameters and their variations are presented in Table 6.12. Four crack locations were analyzed to determine the most critical one in which the highest  $J$ -integral occurs. The  $J$ -integral values were found to be higher at Cracking Location 4 than the other three cracking locations.

Therefore, ANN was constructed and trained using the FEM results at Location 4 as the default location for prediction of the maximum  $J$ -integral. Based on different combinations of all the variables, such as material properties, structure thicknesses, traffic loading, and crack depths (shown in Table 6.13), 194,400 cases were simulated, and these results were used to develop the ANN model for  $J$ -integral prediction. The ANN model can thus be used to predict the  $J$ -integral at any given realistic pavement depth and for different pavement conditions.

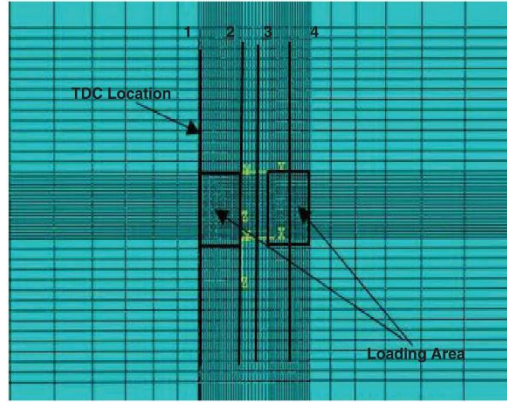


Figure 6.20. Crack Locations and Mesh Details of FEM in Crack and Loading Areas (81).

Table 6.12. Material and Structure Inputs in the FEM (81).

Layer type	Thickness (mm)	Crack ratio	Crack location	Poisson's ratio	Layer modulus (MPa)		
					Modulus gradient	Surface modulus	Elastic modulus
Asphalt	25, 75, 125, 200, 300, 500	0.1, 0.3, 0.5 0.7, 0.9	4	0.35	$n = 0.5, 2, 5$ $k = 0.5, 1.2, 2.5$	500, 2000, 8000, 30000	
Base	150, 300, 500	na	na	0.4			150, 300, 600, 7000, 14000
Subgrade	na	na	na	0.4			30, 150

Note: na = not applicable.

The FEM model used in (81) adopted a rectangular tire contact area to evaluate  $J$ -integrals and the effect of tire load on TDC behaviors. The tire width is assumed to be constant even under different tire pressure within each tire load category. The tire patch and tire load applied to pavement surface are shown in Figure 6.21. Based on these assumptions, the tire patch length is considered a variable parameter that changes with the magnitude of the tire load. The tire patch length is calculated as:

$$\text{tire length} = \frac{\text{tire load}}{\text{tire pressure} \times \text{tire width}} \quad (6.24)$$

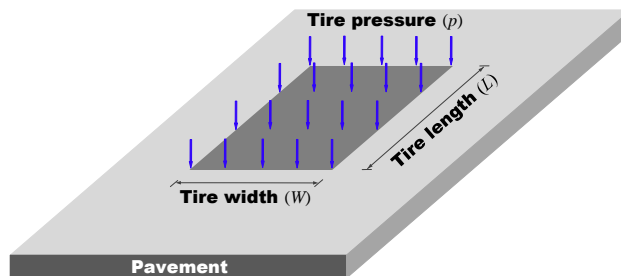


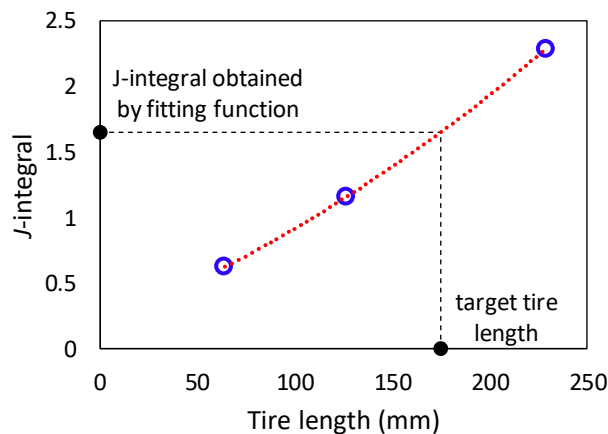
Figure 6.21. Tire Patch and Tire Load Applied to Pavement Surface.



**Table 6.13. Required Input Parameters and Outputs for Trained ANN.**

Input						Output					
Crack depth (mm)	Modulus of asphalt layer (MPa)	Modulus of base (MPa)	Modulus of subgrade (MPa)	Thickness of AC layer (mm)	$n$	$J$ -integral					
						Tire length single tire (mm)			Tire length dual tire (mm)		
						64	305	406	19	185	229

Since the tire length is proportional to tire load magnitude, the CALD versus load intervals can be converted to CALD versus load patch length. In the ANN model, the tire patch length is equivalent to load magnitude. For any given combination of the parameters listed in Table 6.12, the ANN model will deliver six  $J$ -integral results, which include three  $J$ -integral values for a single tire type with 64-, 305-, and 406-mm tire length, and three  $J$ -integral values for a dual tire type with 19-, 185-, and 229-mm tire length, respectively. Each tire length represents a specific tire load magnitude that can be back-calculated according to the tire type using Equation (6.24). The  $J$ -integral result from any reasonable tire load can be found using these three  $J$ -integral values for a single tire type. Figure 6.22 shows a series of typical  $J$ -integral results versus a tire patch for a dual tire type and prediction of  $J$ -integrals with any reasonable tire length through curve fitting.



**Figure 6.22. Typical Plot of J-integral versus Tire Patch for Dual Tire Type and Prediction of J-integral with Any Reasonable Tire Length through Curve Fitting.**

## PREDICTIVE MODEL OF PAVEMENT ME DESIGN FOR RUTTING AND BOTTOM-UP CRACKING

### Rutting Prediction

Rutting is one of the most typical types of load-associated distresses for flexible pavement. Common locations where permanent deformation or rutting may occur are in the wheel path. Rutting develops gradually by accumulation of traffic repetitions, and it normally appears as a longitudinal depression in the wheel paths with upheavals at both sides of the depressions. Each layer (generally asphalt and unbound material layers) in the pavement structure contributes to the

total rut depth. Therefore, the depth and width of rutting highly depend on the traffic matrix and pavement structure.

The predictive rutting model incorporated in the pavement ME design was adopted in this study to evaluate permanent deformation of each rut-susceptible layer. In the pavement ME design, the damage or rutting is calculated for each sub-season because the average temperature of each sub-season falls into different ranges. Each layer, such as the asphalt layer, is subdivided into several sublayers, and during a sub-season, the plastic strain is calculated at the mid-depth of each sublayer. All the permanent deformations of all the sublayers are added up to give the overall permanent deformation for a given sub-season, which is expressed as:

$$PD = \sum_{i=1}^{n\_sublayers} \varepsilon_p^i h^i \quad (6.25)$$

where  $PD$  equals pavement permanent deformation;  $n\_sublayers$  is the number of sublayers,  $\varepsilon_p^i$  is the total plastic strain in sublayer  $i$ , and  $h^i$  is the thickness of sublayer  $i$ .

The procedure for estimating permanent deformation for asphalt, base/subbase and subgrade layers is summarized below:

- Divide AC layer into nine sublayers with identical thicknesses for each sublayer.
- Collect traffic data of AADTT from LTPP database and transfer them into equivalent single-axle loads as number of load repetition.
- Calculate the accumulated permanent strain of each sublayer based on the numbers of load repetitions using the equation below:

$$\log\left(\frac{\varepsilon_p}{\varepsilon_r}\right) = -6.631 + 0.435 \log N + 2.767 \log T + 0.110 \log S + 0.118 \log \eta + 0.930 \log V_{\text{eff}} + 0.5011 \log V_a \quad (6.26)$$

where  $\varepsilon_p$  is accumulated permanent strain,  $\varepsilon_r$  is resilient strain,  $N$  is the number of load repetitions,  $T$  is the mix temperature (deg F),  $S$  is deviatoric stress (psi),  $\eta$  is viscosity at Deg F ( $10^6$  poise),  $V_{\text{eff}}$  is effective asphalt content percent by volume, and  $V_a$  is air void content.

The vertical resilient strain at a given depth is expressed as:

$$\varepsilon_{rz} = \frac{1}{|E^*|} (\sigma_z - \mu\sigma_x - \mu\sigma_y) \quad (6.27)$$

where  $E^*$  is dynamic modulus, obtained from the dynamic modulus master curve;  $\sigma_x$ ,  $\sigma_y$ , and  $\sigma_z$  are stresses at the mid-depth of each sublayer in AC layer, obtained from the pavement response module; and  $\mu$  is Poisson's ratio.

- Multiply the accumulated permanent strain by the corresponding sub-thickness to obtain the rut depth of each sublayer given load repetition of  $N$ .
- Calculate the total layer rut depth by summing all incremental sub-rut depths of sublayers:

$$\Delta R_{di} = \varepsilon_{pi} \Delta h_i \quad (6.28)$$

$$R_d = \sum_{i=1}^n \Delta R_{di} \quad (6.29)$$

where  $\Delta R_{di}$  is the incremental rut depth of sublayer  $i$ , and  $R_d$  is the total rut depth of pavement.

The unbound layers are divided into sublayers according to their corresponding thickness. Calculate the accumulated permanent strain of each sublayer based on the number of load repetitions using the following equation:

$$\frac{\varepsilon_p(N)}{\varepsilon_r} = \left( \frac{\varepsilon_0}{\varepsilon_0} \right) e^{-\left(\frac{\rho}{N}\right)^\beta} \quad (6.30)$$

where  $\log \beta = -0.61119 - 0.017638W_c$ , in which  $W_c$  is the moisture content.

$$\text{For } N=1, \frac{\varepsilon_p(1)}{\varepsilon_r} = a_1 E^{b_1}$$

$$\text{For } N=10^9, \frac{\varepsilon_p(10^9)}{\varepsilon_r} = a_9 E^{b_9}$$

where  $E$  is the modulus of the unbound layer,  $a_1 = 0.15$ ,  $a_9 = 20.0$ ,  $b_1 = 0.0$ , and  $b_9 = 0.0$ , respectively.

Substituting the following equations and  $\varepsilon_r$ , calculated using Equation (6.27), into

Equation (6.30), the plastic strain  $\varepsilon_p(N)$  and permanent deformation  $R_d = \sum_{i=1}^n \varepsilon_{pi} \Delta h_i$  of the base is obtained.

$$\rho = 10^9 \left( \frac{C_0}{[1 - (10^9)^\beta]} \right)^{\frac{1}{\beta}} \quad (6.31)$$

$$C_0 = \ln \left( \frac{a^1 * E^{b_1}}{a^9 * E^{b_9}} \right)^{\frac{1}{\beta}} \quad (6.32)$$

Finally, to compute the permanent deformation of the subgrade, the parameters  $\left( \frac{\varepsilon_0}{\varepsilon_r} \right)$ ,  $\beta$ , and  $\rho$  are calculated at the top ( $z = 0$ ) and 6 inches below ( $z = 6$ ) the subgrade layer using the equations below:

$$\log \left( \frac{\varepsilon_0}{\varepsilon_r} \right) = -1.69867 + 0.09121W_c - 0.11921\sigma_d + 0.91219 \log E_r \quad (6.33)$$

$$\log \beta = -0.9730 - 0.0000278W_c^2\sigma_d + 0.017165\sigma_d - 0.0000338W_c^2\sigma_\theta \quad (6.34)$$

$$\log \rho = 11.009 + 0.000681W_c^2\sigma_d - 0.40260\sigma_d + 0.0000545W_c^2\sigma_\theta \quad (6.35)$$

Using the parameters above, the plastic strain for both depths can be estimated as:

$$\varepsilon_p = \left( \frac{\varepsilon_0}{\varepsilon_r} \right) e^{-\left(\frac{\rho}{N}\right)^\beta} \varepsilon_v \quad (6.36)$$

where  $\varepsilon_v$  is the average vertical resilient strain in the layer/sublayer.

Next, using the model structure described and two data points, solve for regression constant  $k$ :

$$k = \frac{1}{6} \ln \left( \frac{\varepsilon_{p,z=0}}{\varepsilon_{p,z=6}} \right) \quad (6.37)$$

After obtaining  $k$  and  $\varepsilon_{p,z=0}$ , Equation (6.38) is used to calculate the plastic strain at different depths at load repetition number  $N$ .

$$\varepsilon_p(z) = (\varepsilon_{p,z=0}) e^{-kz} \quad (6.38)$$

where  $\varepsilon_p(z)$  is the plastic vertical strain at depth  $z$  measured from the top of the subgrade;  $\varepsilon_{p,z=0}$  is the plastic vertical strain at the top of the subgrade.

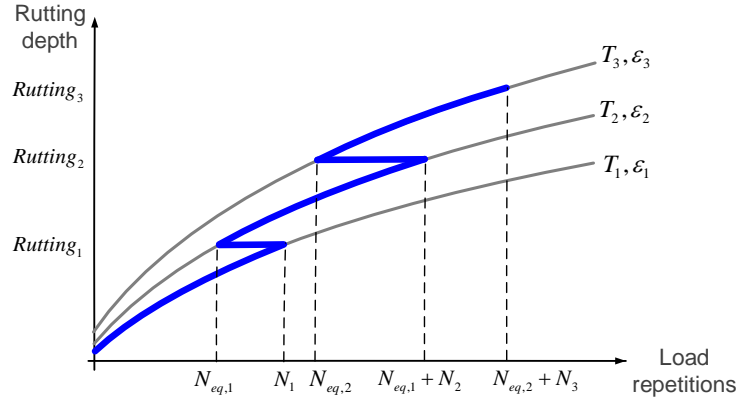
Then, the total permanent deformation of the subgrade layer is obtained by integrating Equation (6.38) through the whole thickness of the subgrade:

$$\delta = \varepsilon_{p,z=0} \int_0^{h_{bedrock}} e^{-kz} dz = \left( \frac{1 - e^{-kh_{bedrock}}}{k} \right) \varepsilon_{p,z=0} \quad (6.39)$$

where  $\delta$  is the total plastic deformation of the subgrade, and  $h_{bedrock}$  is the depth of bedrock from the top of subgrade.

The total rutting is obtained by summing up the permanent deformation of the AC, base, and subgrade layers. In order to account for the variation of temperature, material aging, and dynamic modulus change of the AC over time, the strain hardening approach was adopted to calculate the total plastic deformation in each sub-season  $i$ . Figure 6.23 shows the schematic of this rutting accumulation method. As mentioned, the accumulated rutting is a function of resilient strain  $\varepsilon_r$ , temperature  $T$ , and load cycles  $N$ . The procedures are as follows:

- The accumulated rutting at the end of sub-season 1 ( $Rutting_1$ ) is captured by adopting the condition of temperature  $T_1$ , strain  $\varepsilon_1$ , and the number of load repetitions  $N_1$  for this sub-season.
- At the beginning of sub-season 2, since the conditions have changed, the rutting for this sub-season needs to be calculated on another curve representing a function with updated temperature  $T_2$  and strain  $\varepsilon_2$ , shown in Figure 6.23. Since the initial rutting of each sub-season equals the accumulated rutting at the end of the last sub-season, the equivalent number of load repetitions  $N_{eq,1}$  is calculated accordingly in order to process the following calculation.
- A updated load repetition ( $N_{eq,1} + N_2$ ) is used to calculate the rutting at the end of sub-season 2 ( $Rutting_2$ ) using the permanent deformation model under the condition of temperature  $T_2$  and strain  $\varepsilon_2$ .
- Repeat the steps above until the end of the analysis period.



**Figure 6.23. Schematic of Rutting Accumulation Method.**

### Bottom-Up Cracking Prediction

Another important type of load-associated distress that occurs in flexible pavement is fatigue (bottom-up) cracking. Bottom-up fatigue cracking normally initiates at the bottom of the AC layer where the maximum tensile strain occurs, mainly because the bending effect of asphalt layers results in flexural stresses at the bottom of the surface layer. Once the crack initiation occurs at the bottom of the AC layer, the crack will propagate through the entire layer to the surface, which allows water to seep into the layers underneath and eventually weaken the pavement structure. The number of cycles to failure due to fatigue BUC is calculated from the following equation in pavement ME design:

$$N_f = 0.00432 \beta_{f1} C \left( \frac{1}{\varepsilon_t} \right)^{3.9492} \left( \frac{1}{E} \right)^{1.281} \quad (6.40)$$

where  $\varepsilon_t$  is tensile strain at the critical location;  $E$  is stiffness of the material.

Estimation of fatigue damage is based on Miner's Law, which is expressed as:

$$\sum_{i=1}^T D_i = \frac{n_i}{N_{fi}} \quad (6.41)$$

where  $D$  is damage,  $T$  is total number of periods,  $n_i$  is traffic in period  $i$ , and  $N_{fi}$  is allowable failure repetitions under conditions prevailing in period  $i$ .

The fatigue cracking-damage transfer function, which is used to correlate damage to alligator cracking, is in the form of a sigmoidal function.

$$F.C. = \left( \frac{6000}{1 + e^{(C_1 C_1' + C_2 C_2' \log_{10}(100D))}} \right) \left( \frac{1}{60} \right) \quad (6.42)$$

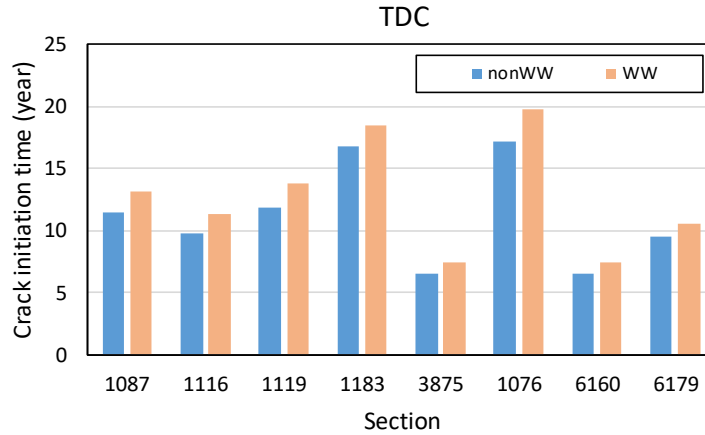
where *F.C.* is percent of alligator cracking (total area of alligator cracking divided by total area of the lane, which is 12 \* 500 = 6000ft<sup>2</sup>).

## RESULTS AND DISCUSSION FOR FLEXIBLE PAVEMENT

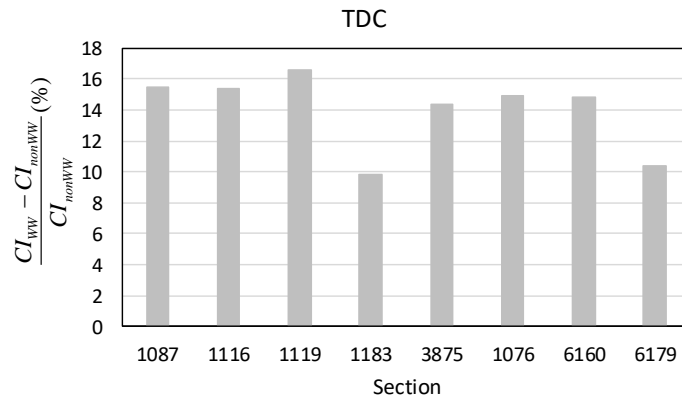
Using the flowchart shown in Figure 6.1, a series of comprehensive pavement performance analysis were performed for 22 Texas flexible pavement sections. Typical pavement distress, including TDC, rutting, and bottom-up fatigue cracking for the individual sections were predicted. By applying the WW coefficients to number of load repetitions or magnitude according to the specified distress type, the effects of the cases with and without WW on the long-term pavement performance were evaluated. As highlighted in the WW section, the WW coefficients are calculated for the individual pavement section since the material properties of AC, base and subgrade layers for each pavement section are different. Because both WW and non-WW conditions exist, the differences between the pavement life and degree of distress development were used to quantify the effects of autonomous truck platooning.

### Top-Down Cracking Analysis

The mechanics-base framework mentioned in previous section was used to evaluate the TDC initiation of Texas LTPP sections. The WW coefficient was applied on the number of load repetitions in order to account for the WW effect on TDC performance. Figure 6.24 shows the comparison of predicted TDC initiation time for WW and non-WW cases. The initiation time for WW cases are from 1 to 2.6 years later than for non-WW cases, which indicates more accumulated damage occurred due to the concentrated load in non-WW cases. Figure 6.25 shows the percentage of TDC initiation time reduction due to non-WW conditions. The sensitivity of the WW effect is different on each section according to different pavement configurations, mixture properties, and environmental conditions that need to be further studied.



**Figure 6.24. Comparison of Predicted TDC Initiation Time for WW and Non-WW Cases.**



**Figure 6.25. Comparison of Predicted Crack Initiation Time for WW and Non-WW Cases.**

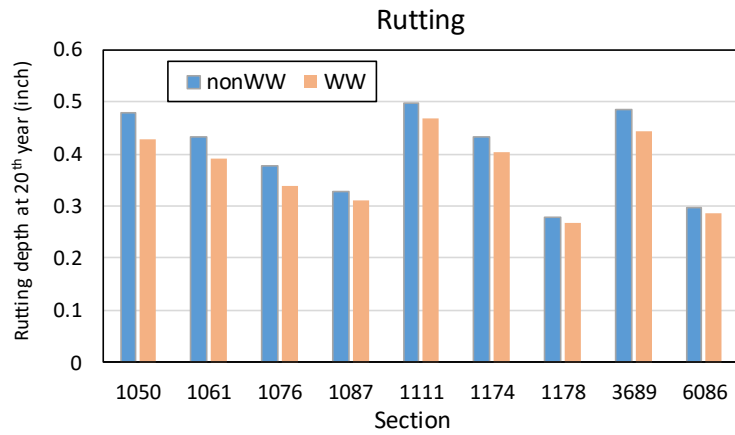
### Rutting Analysis Using Pavement ME Design Model

The pavement ME rutting model was used for evaluating the influence of autonomous trucks on the Texas pavement sections. For the WW effect on rutting, the WW coefficient was applied on the load magnitude, as recommended in the *Pavement ME Design Guide*, in order to account for the WW effect on rutting. Figure 6.18 shows the WW coefficients for rutting prediction on load magnitude for 22 Texas LTPP sections.

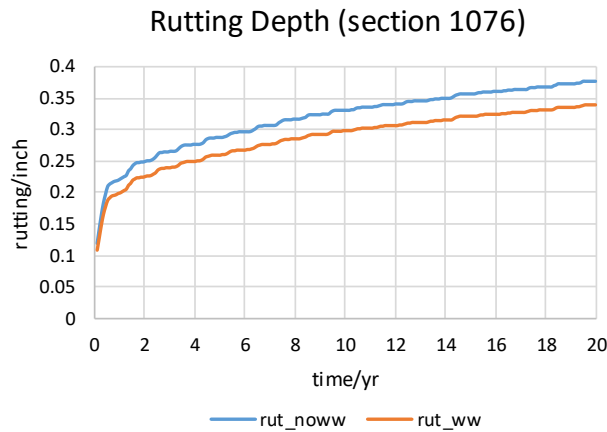
Figure 6.26 shows the comparison of predicted rutting depth for WW and non-WW cases in the 20th year for LTPP sections in Texas. According to simulation results, the majority of flexible pavement sections in the 22 Texas LTPP sections do not reach 0.5 inches of rutting depth within 20 years. Since most of the Texas pavement exhibited very good resistance to rutting in both simulation and field observation, the difference in percentage between WW and non-WW cases, which ranges from 3.8 to 12 percent, is not significant. Figure 6.27 shows the rutting prediction for both WW and non-WW cases for Pavement Section 48-1076. The blue curve in the figures indicates the permanent deformation for non-WW cases, while the orange dash curves are for the cases with WW. The difference between solid and dash curves indicates that a non-WW



condition induces more permanent deformation and reaches the same amount of rutting much earlier than the WW case.



**Figure 6.26. Comparison of Predicted Rutting Depth for WW and Non-WW Cases at 20th Year.**



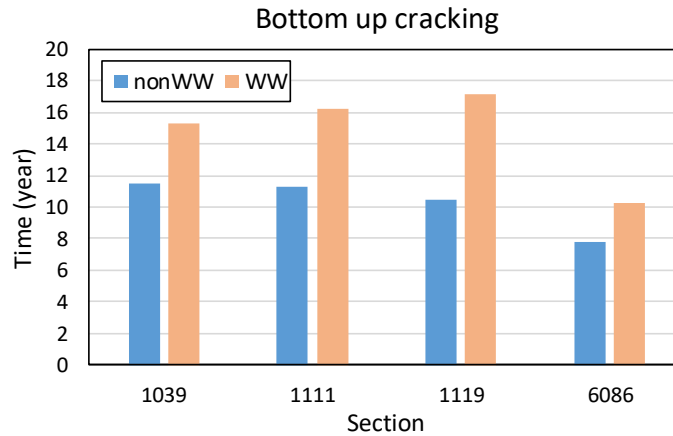
**Figure 6.27. Rutting Evolution for Pavement Section 48-1076.**

### Bottom-Up Cracking Analysis Using Pavement ME Design Model

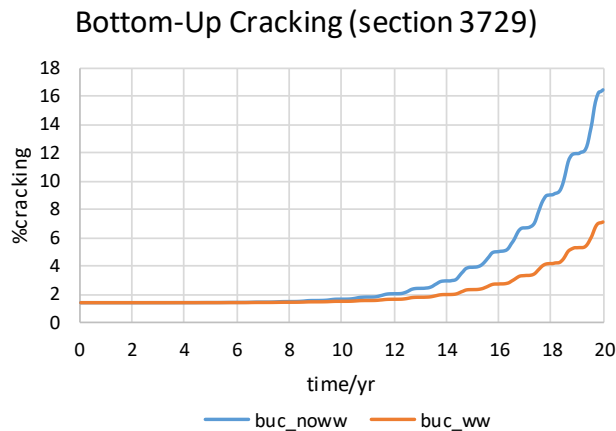
Bottom-up fatigue cracking was analyzed using the BUC model in the *Pavement ME Design Guide*. The pavement ME fatigue cracking model is based on Miner’s rule, where the cumulative damage caused by fatigue correlates linearly with the applied traffic load repetition. The WW coefficient is applied to the number of load repetitions in the same way as the TDC prediction. The calculation procedure takes into consideration the driving force (tensile strain) at the bottom of the AC layer and the variations in the location of the critical response at the bottom of the AC. The WW coefficients for BUC are calculated using the cumulated strain profile at the bottom of the asphalt layer.

Figure 6.28 depicts the time when pavement reaches 25 percent of BUC for both WW and non-WW cases for four LTPP sections in Texas. The BUC life reduction due to non-WW compared

to WW case ranges from 2.4 years to 6.75 years, which indicates considerable variations in performance with respect to bottom-up fatigue cracking. Figure 6.29 shows the BUC predictions for both WW and non-WW cases for Section 48-3729. The blue and orange curves in the figure indicate the percentage of BUC area growth for non-WW and WW cases, respectively.



**Figure 6.28. The Time When Pavement Reaches 25 Percent of BUC for Both WW and Non-WW Cases.**



**Figure 6.29. BUC Evolution for Section 48-3729.**

## PERFORMANCE OF CONCRETE PAVEMENT UNDER EFFECT OF PLATOONED TRAFFIC

The analysis described below addresses both jointed and continuous reinforced concrete (CRC) pavements by comparing the damage effects in a concrete slab subjected to normally distributed loading to the loading concentrated at the traveled wheel path. Jointed plain concrete (JPC) pavement (or contraction design) is made up of individual slabs that range from 15 to 20 ft in length whose performance is mainly a derivate of the loading applied to the corners and edges of the slabs. For CRC pavement, which is typically the costlier pavement type, performance is mainly a function of loading on the slab edges that induces a stress pattern perpendicular to that

experienced in a jointed concrete pavement. Erosion damage immediately below a concrete pavement, particularly along slab edges, has detrimental effects equally on both pavement types.

### Jointed Plain Concrete

The analysis of slab cracking with respect to platooning effects on a concrete pavement is based on accounting for the position of the applied loading and the corresponding expected traffic level, which will vary according to the distance from the traveled wheel path. These factors can be taken into account using the following model form to represent the allowable number of axle loads ( $N_f$ ) before failure due to fatigue cracking:

$$N_f = 10^{k_1 + k_2 r} \quad (6.43)$$

where

$$r = \text{stress ratio} = \frac{\sigma}{f} \quad (0.5 \text{ and } 0.7);$$

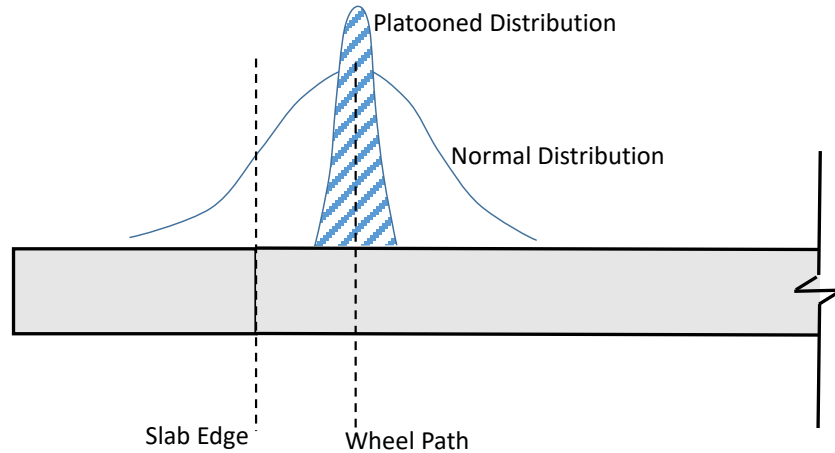
$\sigma$  = total stress (including wheel load stress) as a function of slab support, stiffness, and thickness;

$f$  = concrete flexural strength;

$k_1, k_2$  = fatigue coefficients (17.61 and  $-16.61$ , respectively); and

the concept of damage ( $D = N / N_f$ ) is simply defined as the applied traffic level ( $N$ ) divided by  $N_f$ .

This definition for damage not only accounts for the applied traffic but also for the thickness of the slab, as noted in the determination of the number of allowable loads. For JPC, the effect of the slab thickness, concrete stiffness, and foundation support are all incorporated in the calculated load stress, which in the wheel path is approximately half of the wheel load stress along the edge of the pavement. Damage is empirically related and calibrated to the incidence of slab cracking due to repeated loading. However, before discussing calibration, the determination of damage must be considered.



**Figure 6.30. Normal and Platooned Traffic Distributions.**

One input in the determination of damage is the level of traffic. The key aspect of platooning traffic is the nature of its distribution, which is basically concentrated at the center of the traveled wheel path. A typical distribution of traffic loading centered in the wheel path can be assumed to be normally distributed and encompasses a certain percentage of loading along the edge of the slab (Figure 6.30), while platooned distribution is assumed to be concentrated at the center of the wheel path, with no traffic encroaching upon the slab edge (Figure 6.30). With respect to traffic that is normally distributed, in spite of the reduced amount of traffic along the edge (taken to be 6 percent for this study [82]), the edge is still the critical design position for the consideration of fatigue damage in a concrete slab. Taking these factors (distribution of traffic, load position, stress level) into account, the following relationships between fatigue damage at the edge ( $D_e$ ) of the pavement and damage in the wheel path ( $D_{wp}$ ) is generally represented by:

$$\log(D_{wp}) = \log(D_e) + 3.76 \quad (6.44)$$

The estimate of damage at a given location used to estimate the amount of transverse cracking (%C) in the pavement in this study used the same cracking model used in the Pavement ME software:

$$\%C = \frac{1}{1 + C_4 D^{C_5}} \quad (6.45)$$

where  $C_4$  and  $C_5$  are calibration coefficients determined from field performance data, which are available in the LTPP database. Two sections (Sections C420 and 48-3589) identified from LTPP sites located in Texas, shown in Table 6.14, were selected for calibration purposes. The values for the calibration coefficients  $C_4$  and  $C_5$  were determined from an analysis of slab cracking data that was available for these sites and listed. The values shown in Table 6.14 provide a comparison among the different sections, which include the national default values in

the Pavement ME software. The national coefficients are based on performance nationwide and are shown in Table 6.14 as a matter of convenience since the cracking model used in the Pavement ME software was used in this study as a suitable means to illustrate the effects of platooning on pavement performance.

Before elaborating on the results of the analysis, it must be pointed out, based on the comparison of the values for  $C_5$  (again, each being derived from field performance manifested within each pavement section), that the performance of Texas JPC in general performs much worse than the national average for JPC pavement. This result is likely due to poor curing quality during and shortly after construction (83). Since the origin of the poor level of performance is related to the method of construction, it makes little sense to base future performance projects on flawed methods of construction. If improved curing methodology will result in longer lasting pavements, then calibration, which is carried out to improve the prediction of performance, should be based on performance data that reflect the improved construction methodology.

The performance curves for fatigue cracking for JPC are shown from Figure 6.31 to Figure 6.34. As can be seen, platooning adds approximately an entire magnitude of traffic life to the pavement system. The rate of cracking ( $\%C$ ) is about half of the  $\%C$  rate for normally distributed traffic. The cracking analysis was carried out at both low and high stress ratios ( $r$ ) to represent the range of stress levels under field conditions, but the results for the higher range were not needed in all cases to substantiate the comparison between the two types of distribution. Nonetheless, for the purposes of this analysis, the values of  $r$  ranged from 0.5 to 0.7, which eliminated the need to calculate wheel load stresses that would otherwise be determined from Westergaard-type expressions or finite element modeling representing Westergaard solutions in combination with climatically induced stresses.

**Table 6.14. Fatigue Cracking Calibration Coefficients.**

Fatigue Cracking	Pvmt ME	C420	48-3589
$C_4$	1.0	7.07E-10	2.95E-08
$C_5$	-1.98	-2.12E+01	-1.83E+01

The analysis for faulting was carried out in a similar fashion using the same traffic distributions described above since it was for fatigue cracking but with respect to erosion damage ( $\%E$ ). For faulting, the following model was used:

$$\%E = \frac{f}{f_{\infty}} = e^{-\left(\frac{K_4}{D}\right)^{K_5}} \text{ sigmoidal form as a function of } D \quad (6.46)$$

where

$\%E$  = percent of erosion;

$f_i$  = level of faulting;

$f_\infty$  = ultimate faulting;

$D_i$  = erosion damage function =  $\frac{\sum n_i}{N_f}$  %NWD;

$N_i = \sum n_i$  = equivalent cumulative load applications;

$K_4, K_5$  = erosion calibration coefficients (derived from field or lab data);

%NWD = percent of the year the slab/base interface is wet;

$N_f$  = ultimate loads to failure =  $10^{k_1+k_2i}$  (6.5 and -2.5, respectively);

$k_i$  = erosion fatigue damage calibration coefficients per base type;

$r_i = \frac{\tau_i}{f_e}$  (0.1 and 0.3);

$\tau_i$  = interfacial shear stress;

$f_e$  = effective interfacial frictional resistance or bond strength =  $\sigma_v \mu_e$ ;

$\sigma_v$  = normal stress =  $k_{eff} \Delta$ ;

$k_{eff}$  = effective modulus of subgrade reaction;

$\Delta$  = loaded deflection;

$\mu_e$  = effective coefficient of friction; and

$f_F$  = frictional interfacial shear strength.

Interfacial shear stress can be further broken down as follows:

$$\tau_I = x_b \frac{\partial DE}{\partial X} \frac{1}{k \delta_{L_i}} \frac{E_{sb}}{2(1+\nu)} \frac{1}{\Psi} = x_b \frac{\partial \delta_{L_i}}{\partial X} \frac{E_{sb}}{2(1+\nu)} \frac{1}{\Psi}$$

$$\frac{\partial \delta_{L_i}}{\partial X} = \frac{\partial \delta_{L_i}^*}{\partial x} \frac{P}{L^* k l^2}$$

$$\frac{\partial \delta_{L_i}^*}{\partial x} = b + 2dx + fy$$

$$b = -1.078$$

$$d = 0.919$$

$$f = -4.483$$

Damage due to erosion is a key factor in joint faulting since erosion along the slab/base interface causes a shearing action, which is the genesis of faulting development under a concrete pavement. This type of damage is the result of repeated wheel loading of the pavement, and

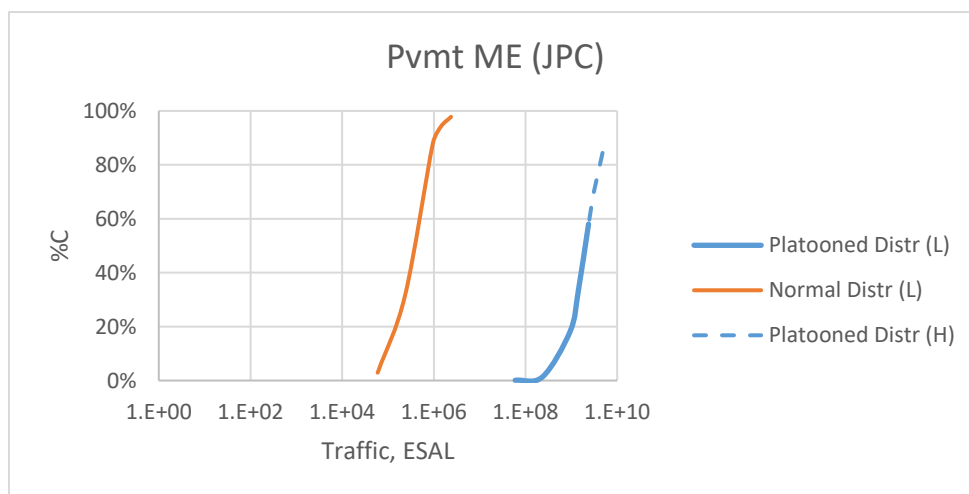
results of the performance analysis results are shown in Figure 6.31 to Figure 6.34. Again, the relationships between erosion damage at the edge of the pavement ( $D_e$ ) and damage in the wheel path ( $D_{wp}$ ) were derived similarly to how fatigue damage was derived—by considering wheel load position, distribution, and stress—resulting in the following:

$$\log(D_{wp}) = \log(D_e) + 2.96 \quad (6.47)$$

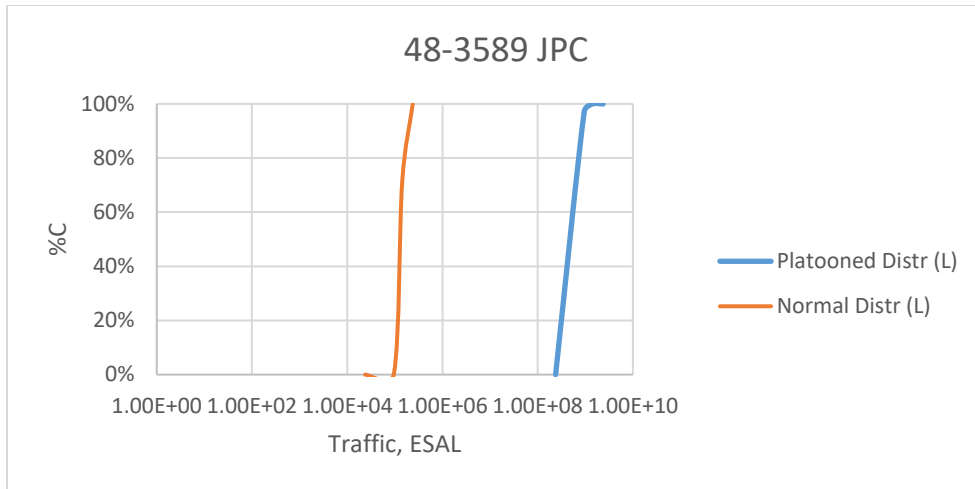
When using this expression and the model for %E, the results indicate a large advantage to platooning with respect to fault development at the joints. However, the rates of fault development are not consistent with the trends shown in the results, most likely due to the concentration of traffic loading in the wheel path associated with erosion and fault damage. This element is likely a characteristic that is perhaps unique to erosion damage. Nonetheless, the erosion analysis was carried at two values of  $r$  (as noted above) to again represent the range of shear stress that may occur under field conditions. The value of %NWD in the model was conservatively taken as 100 percent, which means the joints were assumed to be saturated year-round. The values for  $k_1$  and  $k_2$  were based on laboratory erosion tests of an unbound flexible base material. The values for the erosion calibration coefficients are shown in Table 6.15 for two of the Texas LTPP sections (48-9335 and 48-3003). No values are shown for the faulting model that was used in the Pavement ME software since that model could not be readily adopted to consider the effect of platooning.

**Table 6.15. Erosion Calibration Coefficients.**

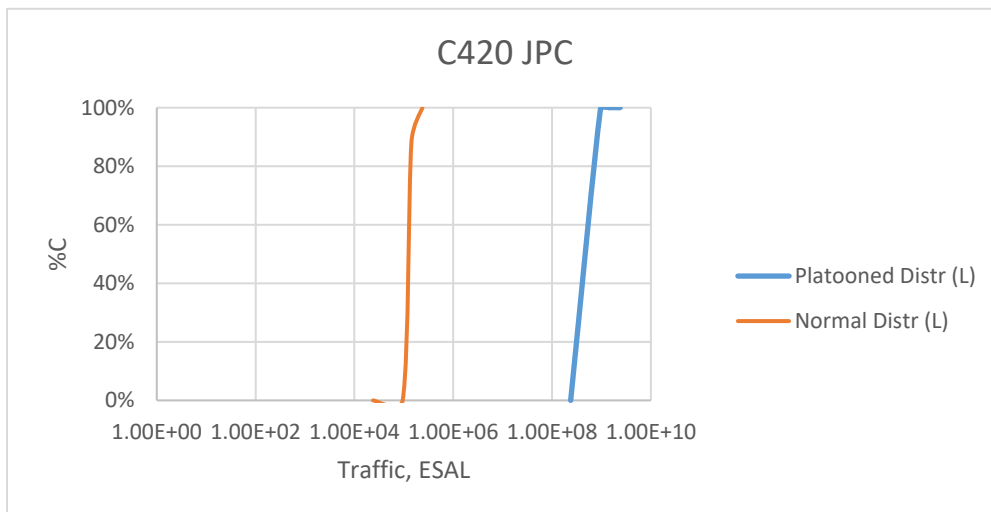
	48-9335	48-3003
$k_4$	5.101E-04	2.44E-01
$k_5$	2.267E-01	8.527E-02



**Figure 6.31. Comparison of Predicted Percent of Cracking under Platooned and Normal Distribution Using Pavement ME.**



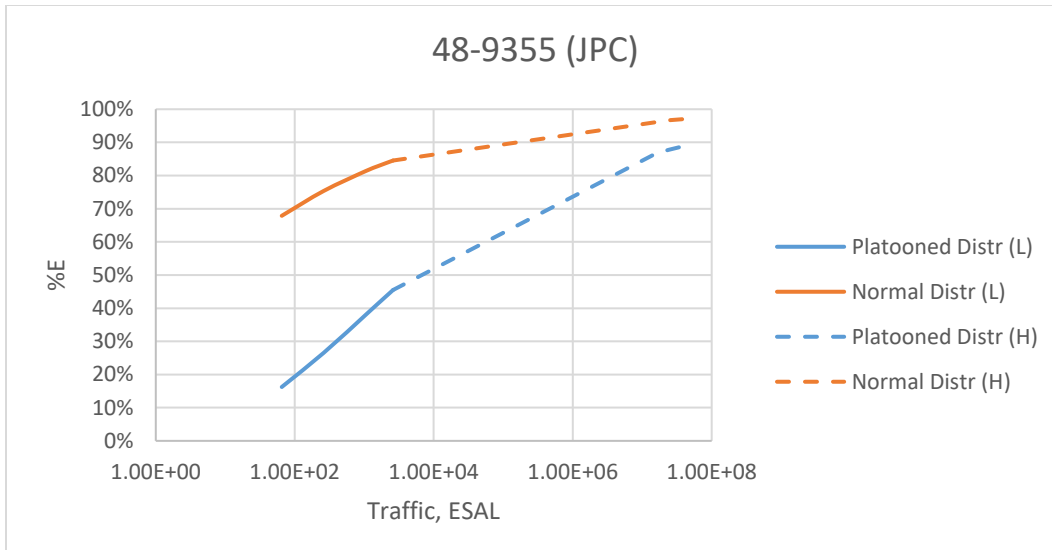
(a)



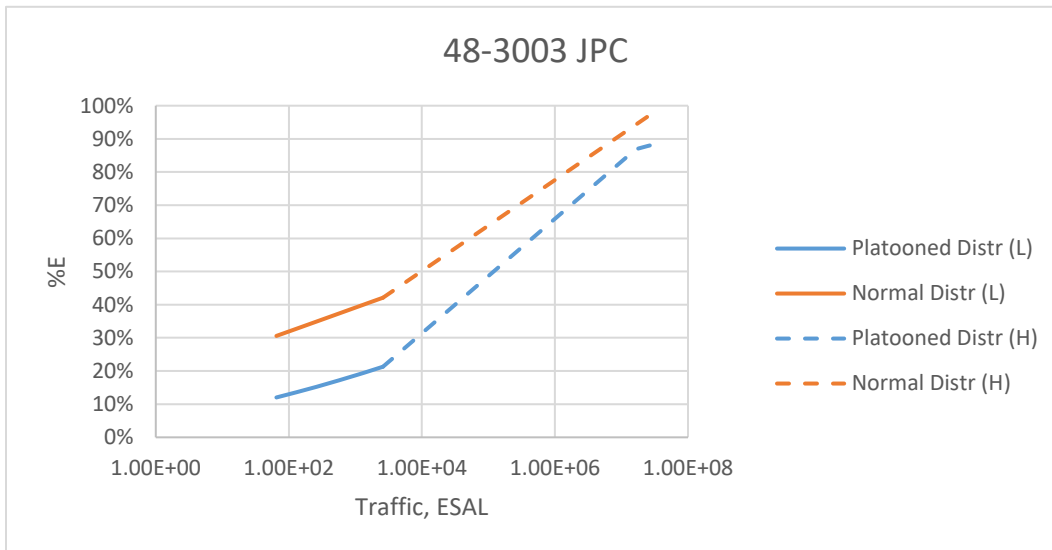
(b)

**Figure 6.32. Comparison of Predicted Percent of Cracking under Platooned and Normal Distribution for LTPP Sections (a) 48-3589 and (b) 48-C420.**



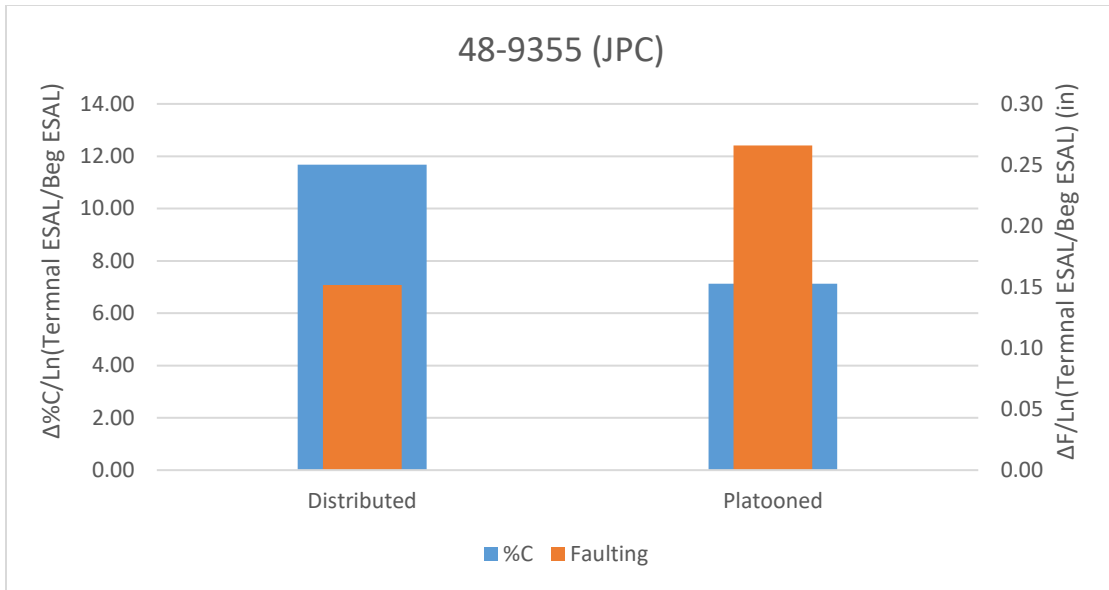


(a)

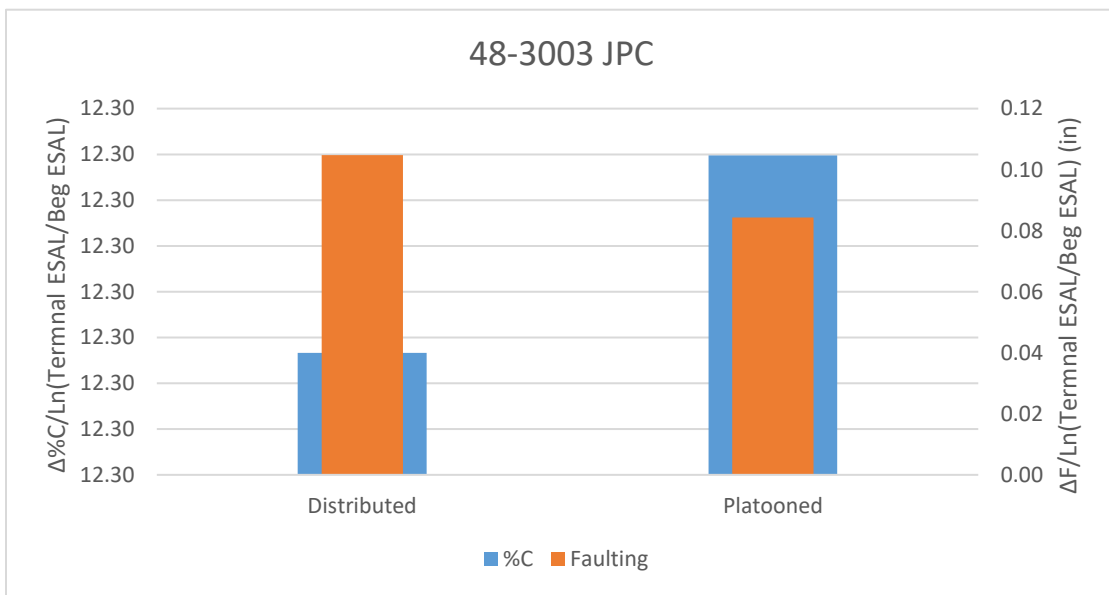


(b)

**Figure 6.33. Comparison of Predicted Percent of Erosion under Platooned and Normal Distribution for LTPP Sections (a) 48-9355 and (b) 48-3003.**



(a)



(b)

**Figure 6.34. Comparison of Percent of Cracking and Faulting Depth per Unit Traffic under Platooned and Normal Distribution for LTPP Sections (a) 48-9355 and (b) 48-3003.**

**CRC Pavement**

For CRC pavement, the comparison of wheel load stress between the stress due to loading in the wheel path and from loading along the pavement edge is done similar to what was carried out for jointed concrete pavement; however, the wheel load stress along the edge of the pavement is at the top of the slab in the transverse direction (in the wheel path), while the stress with the load near the slab edge is at the bottom in the longitudinal direction. This combination of stress patterns alone makes CRC pavement stress patterns unique from the stress patterns that occur in

JPC pavement. Another unique aspect of CRC pavement is that it is the combined effect of erosion damage (% $E$ ) and fatigue cracking (% $C$ ) that initiates the development of punchout distress in a CRC pavement; this element is also the primary distress type in the design of CRC pavement. The wheel load stress levels in this study were represented by the following function:

$$s = \{a + b \ln(L/\ell)\}^{-1} \quad (6.48)$$

where

$$a = \exp(-0.930 + 2.84\{1 + \exp[-(LTE - 96.4)/24.6]\}^{-1});$$

$$b = (0.427 + 9.73 \times 10^{-7} LTE^3)^2;$$

$L$  = mean crack spacing (L);

$\ell$  = radius of relative stiffness (L);

$LTE$  = load transfer efficiency (%);

$s$  = dimensionless stress ( $\sigma_{wls} h^2 / P$ );

$\sigma_{wls}$  = wheel load stress ( $FL^{-2}$ );

$h$  = pavement thickness (L); and

$P$  = wheel load (F).

This function includes the effect of load transfer across the transverse cracks in a CRC pavement structure as well as the spacing between the transverse cracks. These factors were considered in determining the relationships between fatigue damage at the edge ( $D_e$ ) of the pavement and damage in the wheel path ( $D_{wp}$ ), as follows:

$$\log(D_{wp}) = \log(D_e) - 0.62 \text{ (without erosion)} \quad (6.49)$$

and

$$\log(D_{wp}) = \log(D_e) + 0.50 \text{ (with erosion)} \quad (6.50)$$

The coefficients used for the determination of  $N_f$  were the same as those used for the JPC analysis. To represent the relationship with and without erosion effects, two values of the stress ratio ( $r$ ) were assumed for the performance analysis of CRC pavement to represent the stress levels that occur under these conditions. The same assumptions that were applied for the distribution of traffic to the slab edge for the JPC pavement analysis were also used for the CRC pavement analysis.

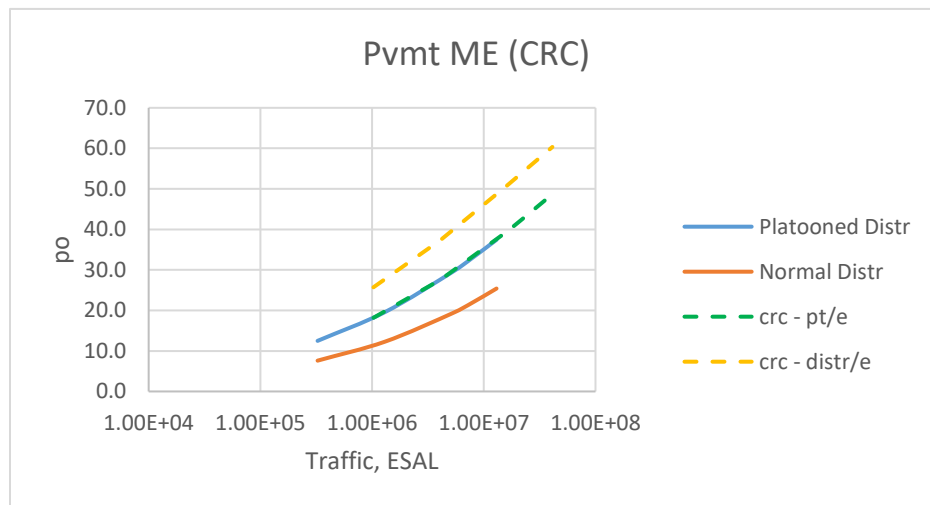
The results for CRC pavement performance analysis are shown from Figure 6.35 to Figure 6.38 and use two LTPP sections of CRC in Texas to calibrate the punchout prediction model. The calibration coefficients for the two Texas LTPP sections are shown in Table 6.16 and can be compared to the national calibration coefficients. The model used for punchout distress prediction is the same as that used in the Pavement ME software:

$$PO = \frac{A}{1 + \alpha D^\beta} \tag{6.51}$$

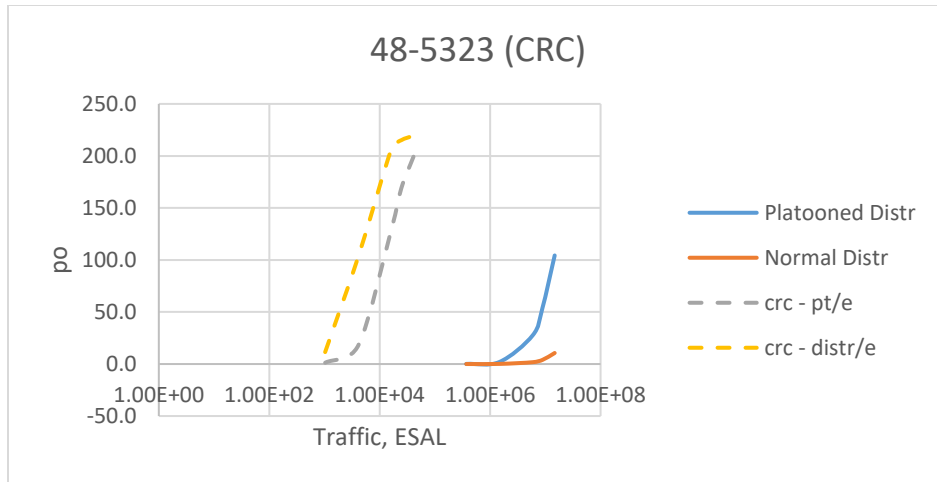
where  $A$ ,  $\alpha$ , and  $\beta$  are the calibration coefficients. The analysis shows that normally distributed traffic yields the best performance when there is no erosion damage below the slab; however, platooning yields the best performance when erosion damage is present. The rates of distress apparently follow the same trends as shown in Figure 6.35 to Figure 6.38—at least in the case of CRC pavements.

**Table 6.16. Punchout Calibration Coefficients.**

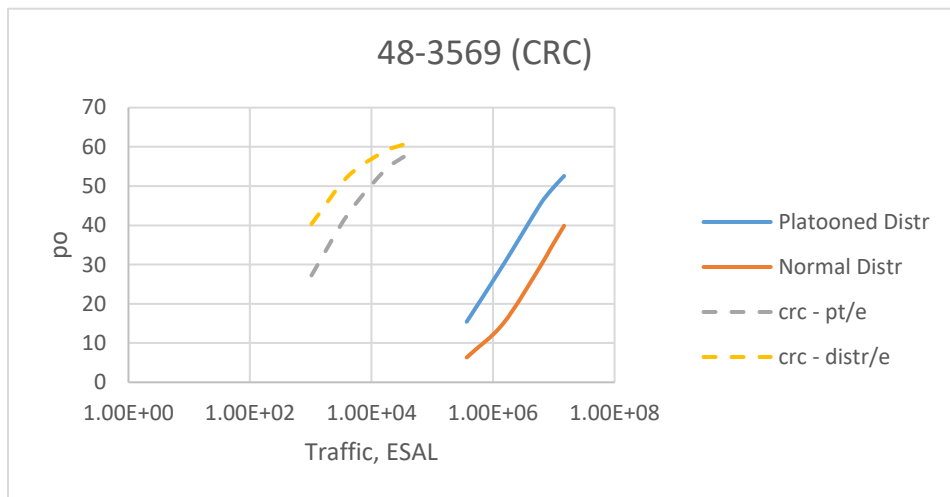
	Pvmt ME	48-5323	48-3569
$A$	107.73	222	63.18
$\alpha$	4	0.0000603	0.0053
$\beta$	-0.38	-2.0	-0.74



**Figure 6.35. Comparison of Predicted Punchout Number Considering with/without Erosion under Platooned and Normal Distribution Using Pavement ME.**

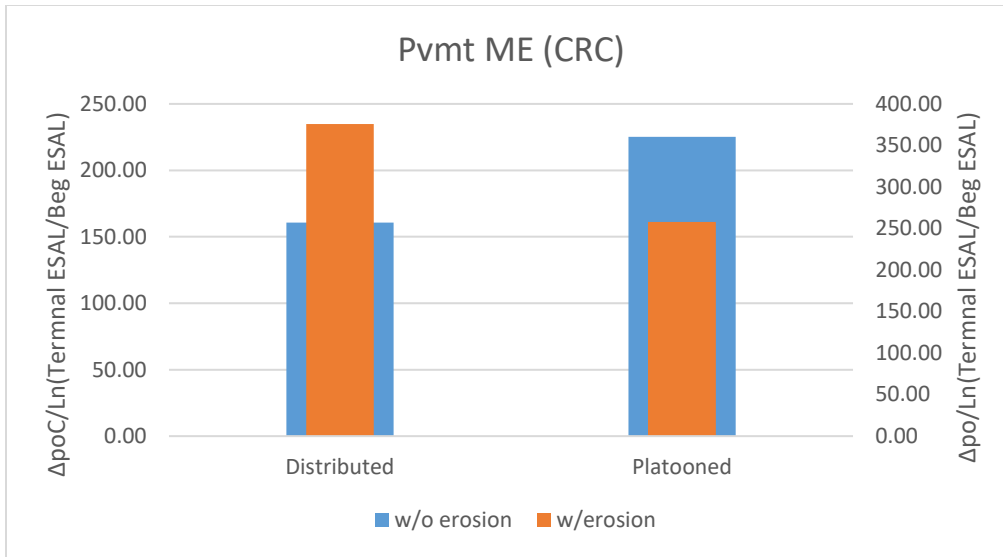


(a)

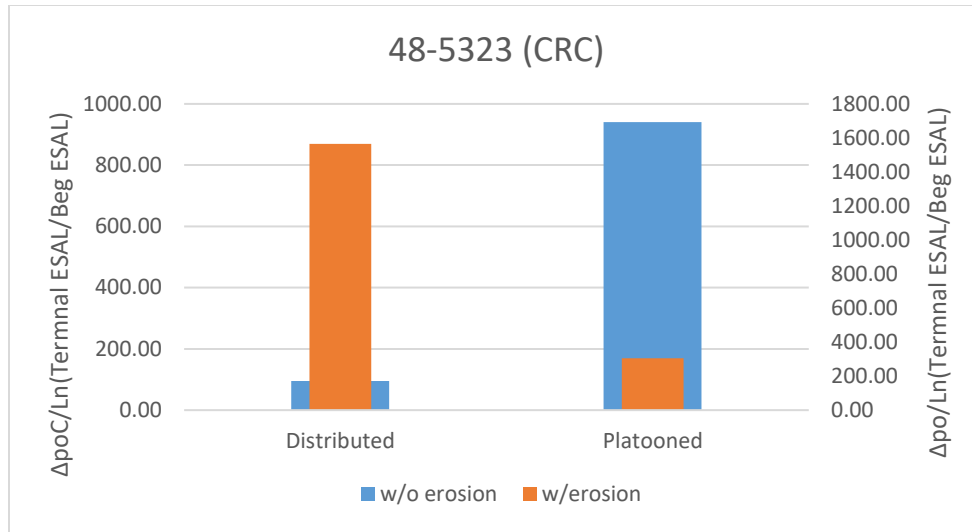


(b)

**Figure 6.36. Comparison of Predicted Punchout Number Considering with/without Erosion under Platooned and Normal Distribution for LTPP Sections (a) 48-5323 and (b) 48-3569.**



**Figure 6.37. Comparison of Punchout Number per Unit Traffic Considering with/without Erosion under Platooned and Normal Distribution Using Pavement ME.**



(a)



(b)

**Figure 6.38. Comparison of Punchout Number per Unit Traffic Considering with/without Erosion under Platooned and Normal Distribution for LTPP Sections (a) 48-5323 and (b) 48-3569.**

### Conclusions

The main conclusion from the results of the analysis is that whether JPC or CRC pavement is involved, a significant advantage to the use of platooning on the longevity of concrete pavement service life exists. However, the full benefit of platooning may not be realized if TxDOT continues to use the same curing standards that it has for years in the construction of new concrete pavements.





## **CHAPTER 7. ASSESSMENT OF TECHNICAL AND PERFORMANCE IMPACTS ON TEXAS BRIDGES**

### **OBJECTIVE**

The objective of Task 4F was to conduct a high-level analytical investigation to identify the impact of future truck platoons on the Texas bridge inventory. The research began with an overall study of all bridges in the state of Texas using the National Bridge Inventory (NBI) database. Further analysis and calculations were performed to determine approximate load ratings under different truck platoon configurations for all bridges likely to foresee future platoons. Finally, a relative prioritization metric was calculated for each bridge, which combines the load rating results and the NBI structural evaluation appraisal ratings that allowed the bridges to be categorized from low to high priority (for more detailed evaluation) prior to future truck platoon implementation. In addition, data analysis was performed to further understand the impact of various parameters on the load rating and prioritization results. Conclusions were drawn regarding the impact of (a) original design methodology, (b) bridge span length, (c) truck type, (d) truck spacing, (e) number of trucks within a platoon, and (f) bridge material.

### **CONTEXT**

Truck platooning falls within the continual bridge concerns for increases in truck size and weight. An isolated truck platoon should not drastically change loading to bridges since similar configurations can be achieved in regular traffic flow. However, the likelihood or frequency of fully loaded trucks in sequence should increase as platoons become more prevalent. To be comprehensive, engineers should revisit several design and evaluation criteria, such as:

- Overload and long-term degradation (focus herein).
- Fatigue.
- Dynamic amplification.
- Braking force.
- Multiple presence.
- Repeated barrier impacts.

Historically, bridges in the United States have been designed for “truck trains,” which are somewhat related to truck platoons. In 1923, “Shoemaker’s Truck Train and Equivalent Load” was proposed and based on five trucks in a train. The magnitude of trucks were 30 kips to 40 kips. The axle-to-axle truck spacing used was 30 ft. This produced an equivalent load of 600 lb/ft with a 28 kip concentrated point force (*100*). Variations of this equivalent load have been part of the US bridge codes up until today. This process can be seen in two different live load models, HS20 and HL93, which were used to design the majority of the bridges in the US inventory. Each of these live load models are explained in more detail below.

## **PRIOR RESEARCH**

Prior related research has been conducted on the impact of truck platoons to highway bridges. One recent study to evaluate the potential truck platoon effects on bridges was performed by the Florida Department of Transportation (FDOT). FDOT conducted an internal study on the impacts of two-truck platoons on bridges in Florida (84). The project was focused on identifying structures that would not meet the needs of a subsequent truck platoon demonstration project. Simple analysis was conducted that primarily scaled the existing NBI (85) load rating factors to estimate the load ratings from the truck platoon. The results of the study identified specific structures that cannot accommodate a two-truck platoon.

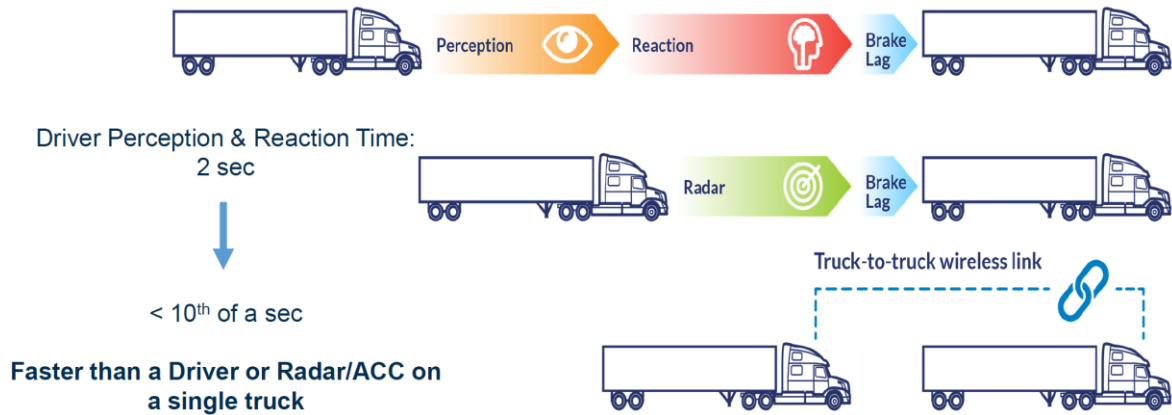
Kamranian (86) evaluated the Hay River Bridge for different combinations of truck platoons. This included two-, three- and four-truck platoons of Alberta non-permit and Alberta permit trucks. It was found that the bridge had adequate capacity for two-truck platoons. However, for three- and four-truck platoons, the load ratings were insufficient.

Another recent study by Yarnold and Weidner (87) performed a study of the live load demands for various bridge configurations and span lengths based on various semi-tractor trailer platoon arrangements. A parametric study was performed that identified potential bridge configurations that may be subjected to increased live load demands because of autonomous truck platoon technology. This research was studied further by Tohme (88), and a similar configuration of bridges and truck platoons were investigated. However, this study calculated and compared load ratings for steel girder bridges (88).

## **BACKGROUND**

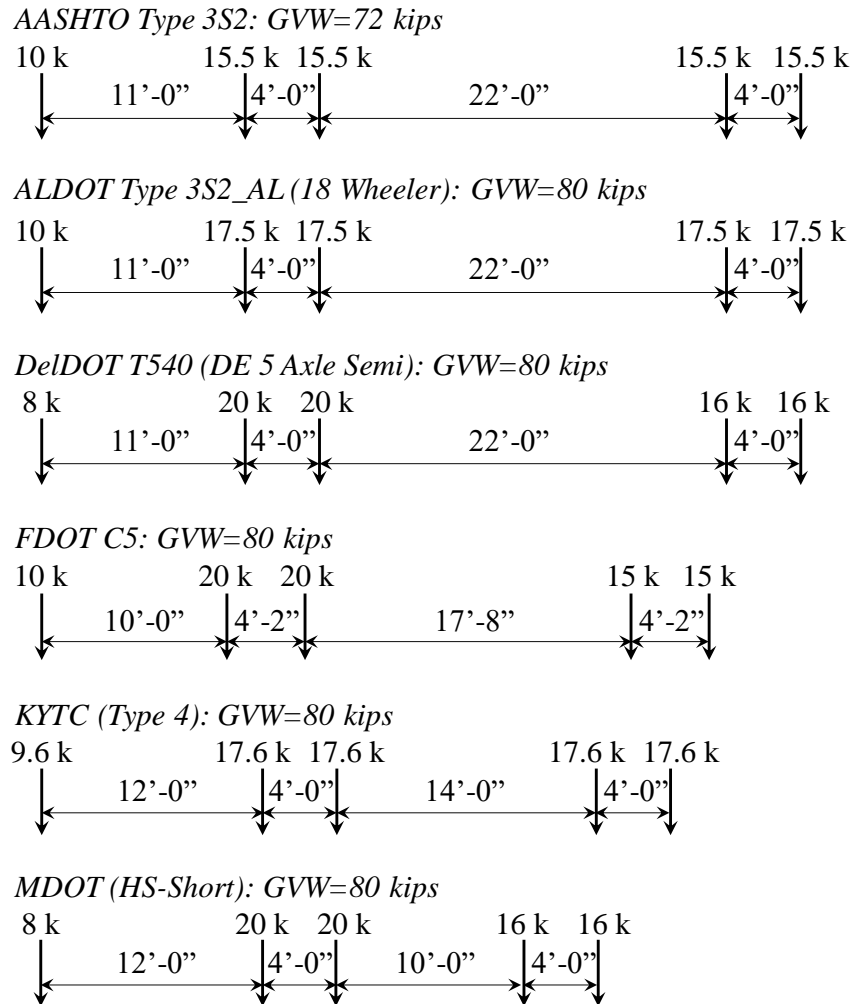
### **Truck Platoon Parameters of Interest to Bridges**

Critical parameters, particularly for bridge impacts, are the spacing between the trucks and the number of trucks within a platoon. Figure 7.1 illustrates the potential reduction in truck spacing due to the truck-to-truck wireless technology. The specific spacing is still not defined; however prior studies and manufacturers have shown a clear gap spacing of around 20 to 40 ft between trucks as feasible (89, 90). Consequently, this study utilized a constant 30-ft and 40-ft rear axle to front axle truck spacing for the bridges evaluated. The number of trucks within a platoon has varied among the different demonstration projects. Primarily, the platoons were comprised of two, three, and four trucks per platoon. For this study, two- and three-truck platoons were considered. The majority of Texas bridges are not long enough to fit four trucks on the structure at one time.



**Figure 7.1. Truck-to-Truck Minimum Following Distance in a Platoon (91).**

Another critical parameter is the specific truck used to make up the platoons. The majority of the prior demonstration projects utilized five-axle semi-tractor trailer platoons. For selection of the specific truck within each platoon, NCHRP Report 575 (*Legal Truck Loads and AASHTO Legal Loads for Posting*) was reviewed, along with numerous state department of transportation bridge design manuals. The vehicles included in this study were the Alabama 3S2\_AL (18-wheeler) (92), Delaware T540 (DE five-axle semi) (93), Florida C5 (94), Kentucky Type 4, and the Mississippi HS-Short (95). Figure 7.2 provides the axle weights and spacing for each truck and a comparison to the AASHTO Type 3S2 legal load from the AASHTO *Manual for Bridge Evaluation* (MBE) (96).



**Figure 7.2. Five-Axle Trucks Considered for Truck Platooning.**

In summary, each bridge was analyzed for 24 different truck platoons, which included truck platoon arrangements of two and three trucks with constant spacing of either 30 or 40 ft. For each of these arrangements, the six five-axle trucks in Figure 7.2 were evaluated.

### **Bridge Load Rating**

Load rating is a mathematical exercise by which the load carrying capacity of a bridge is determined. The specific outcome of the analysis is the rating factor (RF). Essentially, the RF is a ratio of the calculated live load capacity of the bridge (removing dead load demands) to the live load demands. The purpose of the rating is to provide a measure of a bridge's ability to carry a given live load in terms of a simple RF. These bridge rating factors can be used by owners to aid in decisions about the need for load posting, bridge strengthening/replacement, overweight load allowances, and bridge closures. In the United States, there are three primary load rating methodologies, which are performed at two different levels. These methods are further explained below.

### *Load and Resistance Factor Rating (LRFR)*

LRFR was developed as a rating methodology consistent in philosophy with the AASHTO Load and Resistance Factor Design (LRFD) Bridge Design Specifications in its use of reliability-based limit states. The goal of the design philosophy in AASHTO LRFD is to achieve a more uniform level of reliability in bridge design. The equation to determine the rating factor by the LRFR method ( $RF_{LRFR}$ ) is given in Equation (7.1) (excluding the permanent loads portion) (96). In this expression, the primary variables are the capacity ( $C$ ), dead load of the components ( $DC$ ), wearing surface ( $DW$ ), and the live load ( $LL$ ). The load factors for the dead load of the component, dead load of the wearing surface, and live load are defined as  $\gamma_{DC}$ ,  $\gamma_{DW}$ , and  $\gamma_{LL}$ , respectively. The dynamic amplification of the static live load is accounted for with the  $IM$  factor.

$$RF_{LRFR} = \frac{C - \gamma_{DC}DC - \gamma_{DW}DW}{\gamma_{LL}(LL * IM)} \quad (7.1)$$

### *Load Factor Rating (LFR)*

The LFR method is similar to the LRFR method. LFR recognizes that certain design loads, such as live load ( $L$ ), are more highly variable than other loads, such as dead load ( $D$ ). Therefore, different factors are used for each load type. The capacity ( $C$ ) is based primarily on the estimated peak resistance of a member. The equation to determine the rating factor by the LFR method ( $RF_{LFR\_ASR}$ ) is given in Equation (7.2) (96), where  $A_1$  and  $A_2$  are load factors and  $I$  represents an impact factor (a similar concept to the  $IM$  factor with a different formulation).

$$RF_{LFR\_ASR} = \frac{C - A_1D}{A_2L(1 + I)} \quad (7.2)$$

### *Allowable Stress Rating (ASR)*

For the ASR method, the live loads on the structure and all other loads shall not produce stresses that exceed allowable stresses. In general terms, the allowable stress method limits the stresses produced by service loads to predetermined values that are a percentage of the material limit. The equation to determine the rating factor by the ASR method ( $RF_{LFR\_ASR}$ ) is the same as that given in Equation (7.2). However, the formulation of the capacity ( $C$ ) and the factors  $A_1$  and  $A_2$  are different for ASR.

### *Rating Levels*

There are two different levels used during bridge rating: inventory rating (IR) and operator rating (OR). With respect to vehicle loading, IR can be defined as the vehicle load that can safely utilize a given bridge for an infinite period of time. OR can be defined as the absolute maximum

vehicle load to which the bridge may be safely subjected. Therefore, the ratings are lower at the IR level than at the OR. Note that IR is more consistent with the design level of analysis. For example, the live load factor for the LRFD method is the same as the live load factor for IR using LRFR. According to the AASHTO MBE, load posting is not required for a bridge if it has a sufficient OR. As a result, the final truck platoon ratings in this study were performed at the operating level.

## **METHODOLOGY**

This section explains the overall methodology to realize the primary objective of the study, which was to prioritize the bridges within the state of Texas for future truck platoon loading. First, the bridges most likely to foresee truck platoons were established. This process was accomplished by identifying the Texas bridges in the Strategic Highway Network (STRAHNET), which removed rural bridges where platoons are unlikely. In addition, the scope of the study focused on concrete and steel girder bridges. These structures account for most of TxDOT inventory. The other special structure types (arch, truss, etc.) were removed and designated as outside the limits of the analysis. Then, the following stages of analysis were performed using programs written with Visual Basic and Matlab. Each of the following stages is described in detail below:

1. Extracting NBI Data.
2. Identifying Design Methodology.
3. Calculating Design Live Load Demands.
4. Determining Bridge Capacity and Dead Load Demands.
5. Calculating Truck Platoon Live Load Demands.
6. Calculating Truck Platoon Load Ratings.
7. Determining Bridge Prioritization.

### **Extracting NBI Data**

The NBI is a database of information on all bridges within the United States. Only select NBI information was needed to evaluate the bridges subjected to truck platoons. To calculate estimated load ratings, the year built (Item 27) and, if applicable, the year reconstructed (Item 106) were recorded. This information was later utilized to determine the original design (or rehabilitation) methodology for each bridge. The reason this knowledge was needed is discussed further in the next section. The maximum span length (Item 48) and the member type (Item 43) of each bridge were also recorded, which allowed for future calculation of girder demands and capacities to obtain load ratings. Note that the NBI data include load ratings. However, these values are highly approximate. More refined load ratings were needed for this study.

It was desired to prioritize each structure subjected to future truck platoons. As a result, additional NBI data were used in conjunction with the calculated load ratings. First, the

STRAHNET concrete and steel girder bridges were filtered to remove any with span lengths less than 50 ft (again using Item 48) since truck platoons will have limited impact on these structures. A filter was also applied for bridges with average daily traffic of less than 100 (Item 29) due to the unlikely occurrence of future platoons on these roadways. Once the final selection of bridges was established (over 6,000), the primary information utilized for the prioritization was the structural evaluation appraisal ratings (Item 67). This data element gives an evaluation of the structure based on the condition rating of the superstructure (Item 59), condition rating of the substructure (Item 60), and the IR. The highest structural evaluation is represented by the lowest of the condition ratings for the superstructure and substructure. The appraisal rating was later utilized to convert load ratings to a relative prioritization metric for truck platoons (explained further below). To allow for mapping the results, the latitude and longitude for each bridge (Item 16.1 and 17.1, respectively) were recorded. Consequently, the final results were exported to Google Earth to map the research findings. In addition, an Excel tool was developed for easy identification of the specific bridge priorities in each TxDOT district.

### **Identifying Design Methodology**

As mentioned above, the year built (or rehabilitated) was utilized to identify the design methodology for each bridge. Based on a literature review and review of existing TxDOT bridge plans, the following timeframes were established:

- 2005 to Present: Load and Resistance Factor Design (97).
- 1975 to 2004: Load Factor Design.
- Before 1975: Allowable Stress Design (ASD).

One of the main assumptions for this study was the original AASHTO design (or rehabilitation) IR quantities. These assumptions were made for reasonable back-calculation of the bridge capacity and dead load demands, as illustrated in Stage 4 below. Detailed load rating calculations were conducted for concrete and steel girder bridges to make justifiable assumptions. The research team conducted load rating calculations for many existing in-service TxDOT bridges and TxDOT standard girder designs. In addition, results from the literature were also utilized. Table 7.1 and Table 7.2 provide the inventory load rating results for prestressed concrete and steel girder bridges, respectively. These ratings are for the corresponding AASHTO live load demand (discussed further in Step 3 below). Note the prestressed concrete bridge load ratings are well above 1 because the strength limit state ratings are presented, and often the service level stress criteria (not ultimate capacity) commonly controls the design.

**Table 7.1. AASHTO Inventory Load Rating Summary for Prestressed Concrete Bridges.**

	No. of Girders	Mean IR Rating	Lowest IR Rating
<b>LRFR Standard Plans</b>	44	1.62	1.28
<b>LFR Standard Plans</b>	12	1.70	1.50
<b>ASR Standard Plans</b>	23	1.67	1.12
<b>NCHRP 122</b>	7	1.67	1.38
<b>Actual Girders (LRFR)</b>	5	1.78	1.57
<b>Actual Girders (LFR)</b>	5	2.12	1.73

**Table 7.2. AASHTO Inventory Load Rating Summary for Steel Girder Bridges.**

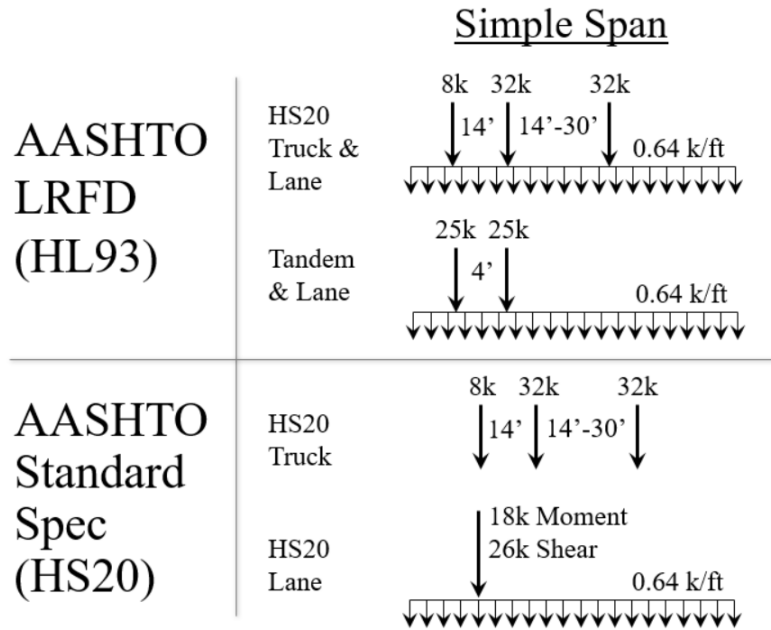
	No. of Girders	Mean IR Rating	Lowest IR Rating
<b>LRFR Standard Plans</b>	47	1.22	1.01
<b>NCHRP 122</b>	38	1.49	0.90
<b>Schelling et.al (1984)</b>	16	1.65	1.36
<b>Actual Girders (LFR)</b>	9	1.27	1.17

Based on these findings, an original design (or rehabilitation) IR was conservatively selected using the 90-percentile standard deviation of the entire data set. This process results in assumed design AASHTO inventory ratings of 1.35 and 1.10 for prestressed concrete and steel girder bridges, respectively. These values are later expressed as the  $\mu$  factor in Stage 4.

### Calculating Design Live Load Demands

The live load demands from the original design (or rehabilitation) methodology (identified for each bridge in the prior stage) were calculated. The current live load model for LFRD is termed HL93 (98). This is a notional load configuration that contains a combined truck/lane load and tandem/lane load. Figure 7.3 illustrates the primary information for HL93 live loading. The older live load model used for LFD and ASD was termed HS20 live load. HS20 is also a notional load configuration that contains the response from a truck and lane load (99). Figure 7.3 illustrates the primary information for HS20 live loading as well. Notice how both HL93 and HS20 live load models incorporate a truck train distributed loading component, developed by Shoemaker in 1923 (100). This loading has a similar concept to truck platooning but was developed using lower magnitude truck and axle forces.





**Figure 7.3. AASHTO HL93 and HS20 Live Loading for Simple Spans.**

The maximum live load moments were calculated for HL93 and HS20 ( $L_{HL93}$  and  $L_{HS20}$ , respectively) for each applicable bridge. Note the assumption that flexure controls were based on prior experience of the research team and review of the existing plans. Even so, one challenge with the maximum moment calculations was the limited information on the span configuration for each bridge. The NBI data only provide the maximum span length and designates whether the bridge is simple span or continuous. Review of the NBI data indicated that approximately 98 percent of the concrete bridges are simple span. Conversely, more than 60 percent of the steel girder bridges are continuous. Therefore, it was decided to calculate the simple span maximum moment for all the concrete bridges and the steel bridges designated as simple span. The remaining steel bridges were analyzed as two-span continuous, and the positive and negative moments were determined.

### Determining Bridge Capacity and Dead Load Demands

The calculation of the bridge capacity and dead load demands were different based on the original design (or rehabilitation) methodology. Therefore, they are explained separately below.

#### *LRFR*

Making an assumption for the IR of each bridge under the original design (or rehabilitation) methodology allows for identification of the numerator of the load rating equation (Equation (7.1)). The numerator is the bridge capacity minus the factored dead load demands, which is defined as the variable  $N_{LRFR}$ . This variable remains constant regardless of the rating

level for a particular bridge. Equation (7.3) provides a new simple expression for the identification of  $N_{LRFR}$ .

$$N_{LRFR} = \gamma_{LL}(L_{HL93} * IM)\mu \quad (7.3)$$

Note that according to AASHTO,  $\gamma_{LL}$  is 1.75 (inventory) and  $IM$  is 1.33 (101). The live load demands ( $L_{HL93}$ ) were those calculated in the prior stage. The defined IRs for concrete (1.35) and steel (1.10) are accounted for with  $\mu$  (explained in Stage 2).

### LFR

A similar approach to LRFR was applied for LFR bridges. The IR assumption ( $\mu$ ) for the original design (or rehabilitation) again allowed for identification of the load rating equation numerator (Equation (7.2)). The LFR numerator is different than LRFR; however, it is still the bridge capacity minus the factored dead load demand ( $N_{LFR}$ ). Equation (7.4) provides a new expression for identification of  $N_{LFR}$ .

$$N_{LFR} = A_2 L_{HS20}(1 + I)\mu \quad (7.4)$$

According to AASHTO,  $A_2$  is 2.17 (inventory) (98). The impact factor ( $I$ ) is 50 divided by the sum of the span length (in feet) and 125 (99). Again, the live load demands ( $L_{HS20}$ ) were those calculated in the prior stage.

### ASR

While the load rating equation for ASR is the same as LFR (Equation (7.2)), the numerator is not constant for IR and OR because the capacity (allowable stresses) varies based on rating level. The factors  $A_1$  and  $A_2$  are 1.0 for ASR. The future truck platoon ratings are for the operating level, so obtaining a combined numerator term by only assuming an IR would be insufficient. As a result, the dead load demands are required to calculate the capacity.

Dead load moments for prestressed concrete bridges ( $D_{conc}$ ) were obtained from the Prestressed Concrete Institute (PCI) for spans lengths ( $S$ ) up to 140 ft. Equation (7.5) was developed by the researchers from the information provided by PCI and TxDOT standard bridge plans. This equation was used for estimation of the concrete bridge dead load moments (ASR only).

$$D_{conc} = -0.05S^2 + 17.476S + 258.57 \quad (7.5)$$

To determine the steel bridge dead load moments, the findings from Hansell et al. (102) were utilized. In the Hansell et al. study, an extensive review of standard steel girder bridges was performed for the Bureau of Public Roads. One of the findings was an estimate for steel bridge

dead load moment ( $D_{steel}$ ) as a function of the live load moment ( $LL$ ) (with impact [ $I$ ]) and the span length ( $S$ ). This expression is presented in Equation (7.6) and was utilized in this study for estimation of the steel bridge dead load moments (ASR only).

$$D_{steel} = 0.0132(LL + I) * S \quad (7.6)$$

The inventory level capacity ( $C_{IR}$ ) was then calculated, taking advantage of the dead load equations above, as shown in Equation (7.7). This equation utilizes Equation (7.2) by again assuming the original design (or rehabilitation) rating  $\mu$ . For the ASR method, the stress levels used to determine bridge capacity are different in that a 55% limit is utilized for inventory and a 75 percent limit is utilized for operating ratings. To obtain the operating level capacity ( $C_{OR}$ ), the inventory capacity is simply multiplied by the ratio of yield stresses, as illustrated in Equation (7.8).

$$C_{IR} = L_{HS20}(1 + I)\mu + D \quad (7.7)$$

$$C_{OR} = \frac{0.75}{0.55} C_{IR} \quad (7.8)$$

### Calculating Truck Platoon Live Load Demands

The maximum truck platoon moments were calculated for each bridge ( $L_{platoon}$ ). This process included the truck platoon moment for all vehicles shown in Figure 7.2. As mentioned earlier, platoons with two and three trucks per platoon were analyzed. In addition, a constant spacing of 30 ft and 40 ft between trucks was considered. Note that the truck platoons were analyzed assuming no other traffic was within the lane (no additional lane loading applied). In addition, the likelihood of trucks in adjacent lanes (accounted for by the multiple presence factor in AASHTO) was not considered. This element has been identified as future work when more information on truck platoon legislation and lane restrictions are established.

### Calculating Truck Platoon Load Ratings

Estimated truck platoon load ratings (operating level) were calculated utilizing the results from the prior five stages. A general assumption for the calculations was that the impact factor (or dynamic load allowance) for truck platoons was the same as that prescribed by AASHTO. Evaluation of any changes to this factor for truck platoons has been identified as future work. It is also worth noting that deterioration was not taken into account at this stage. However, this factor has been included in the prioritization through the appraisal ratings (see Stage 7 below).

The truck platoon load ratings were first calculated for each bridge according to the methodology for which it was originally designed (or rehabilitated) for all 24 truck platoon configurations. Equation (7.9) provides the expression for calculation of the LRFR platoon ratings, where  $N_{LRFR}$

represents the quantity of the capacity minus all the dead load demands using the LRFR method (from Stage 4),  $\gamma_{LL}$  is the live load factor (1.35 for operating),  $IM$  is the dynamic load allowance (equal to 1.33), and  $L_{platoon}$  is the truck platoon maximum moment (from Stage 5).

$$RF_{LRFR} = \frac{N_{LRFR}}{\gamma_{LL}(L_{platoon} * IM)} \quad (7.9)$$

Equation (7.10) provides the equation for calculating the LFR platoon ratings, where  $N_{LFR}$  represents the quantity of the capacity minus all the dead load demands using the LFR method (from Stage 4),  $A_2$  is the live load factor (1.30 for operating), and  $I$  is the impact factor (calculation described in Stage 4).

$$RF_{LFR} = \frac{N_{LFR}}{A_2 L_{platoon} (1 + I)} \quad (7.10)$$

Equation (7.11) shows how to calculate the ASR platoon ratings, where  $C_{OR}$  represents the operating level capacity using the ASR method (from Stage 4),  $D$  represents the dead load demand (from Stage 4), and  $A_1$  and  $A_2$  are load factors (each equal to 1.0).

$$RF_{ASR} = \frac{C_{OR} - A_1 D}{A_2 L_{platoon} (1 + I)} \quad (7.11)$$

The three different rating methodologies do not ensure the same reliability. Therefore, in order to compare the ratings of all bridges, consistent load ratings were desired. The decision was made to convert the LFR and ASR ratings to estimated LRFR ratings. This process is not trivial. A substantial literature review was conducted to determine the appropriate conversion factors, which are provided in the following subsections. Note that these conversion factors are simply multiplied by the original load rating to provide an estimated LRFR value.

#### *LFR to LRFR Conversion*

NCHRP Project 20-07, Task 122 (103) and NCHRP Report 700 (104) were used as the basis for LFR to LRFR conversion. Both the studies are similar in that the load ratings were done analytically using AASHTO Bridge rating software VIRTIS and AASHTOWARE, respectively. In NCHRP 122, 74 representative bridge plans obtained from NYSDOT were analyzed to compare the LRFR and LFR method of rating. NCHRP 700 provides detailed bridge data of 1,500 bridges from eight states. The study involved the comparison of IR by LRFR and LFR methods for different span configurations and material types. The data from both studies have been implemented using a weighted average to obtain the final conversion factor from LFR to LRFR for concrete and steel bridges, which is equal to 0.50 and 0.77, respectively.

### *ASR to LFR Conversion*

National Cooperative Highway Research Program (NCHRP) Report 91-1 (105) and Schelling and Fu (106) were used as the basis for ASR to LFR conversion. Schelling and Fu conducted manual load rating studies of 16 bridges by LFR and ASR methods. The results of the study were used to develop a regression equation for the conversion. The NCHRP report extensively studied 73 bridges (33 concrete and 40 steel bridges) to obtain the rating factors under different types of design trucks by LFR and ASR ratings. The bridges studied were identified as those that required posting or were on the verge of being posted using analysis by the ASR method. A weighted average was used to obtain the ASR to LFR conversion factors for concrete and steel bridges, which is equal to 0.47 and 0.88, respectively.

### **Determining Bridge Prioritization**

The final stage of the research was to prioritize (or rank) each structure for carrying future truck platoon loading. This step was a high-level approach to help identify the bridges that may receive the earliest attention. The rankings were made using a prioritization metric (PM). The PM was calculated as the product of the converted LRFR load ratings (from Stage 6) and the appraisal rating factors provided in Table 7.3 (further explanation of the specific values is given below). This effort allowed for prioritization such that all bridges could be compared across all generations of bridges.

**Table 7.3. Condition Factors.**

<b>Appraisal Rating</b>	<b>&gt;7</b>	<b>7</b>	<b>6</b>	<b>5</b>	<b>&lt;5</b>
<b>Factors</b>	1	0.85	0.75	0.60	0.50

The specific values for the factors provided in Table 7.3 were inferred from the NBI Coding Guide. Item 67 (Structural Evaluation) provides a table with a rating based on the structural evaluation rating code. These ratings were normalized (and rounded) to obtain the conversion factors in Table 7.3.

For simplicity, the bridges were grouped into five categories. Category 1 represents the lowest priority bridges, whose PM values are greater than 1.0. Category 5 represents the highest priority bridges, whose PM values are less than 0.70. The prioritization results are provided in the next section. Note that special bridges outside the limits of the analysis approach (e.g., trusses, arches, etc.) are given a Category 0 designation.

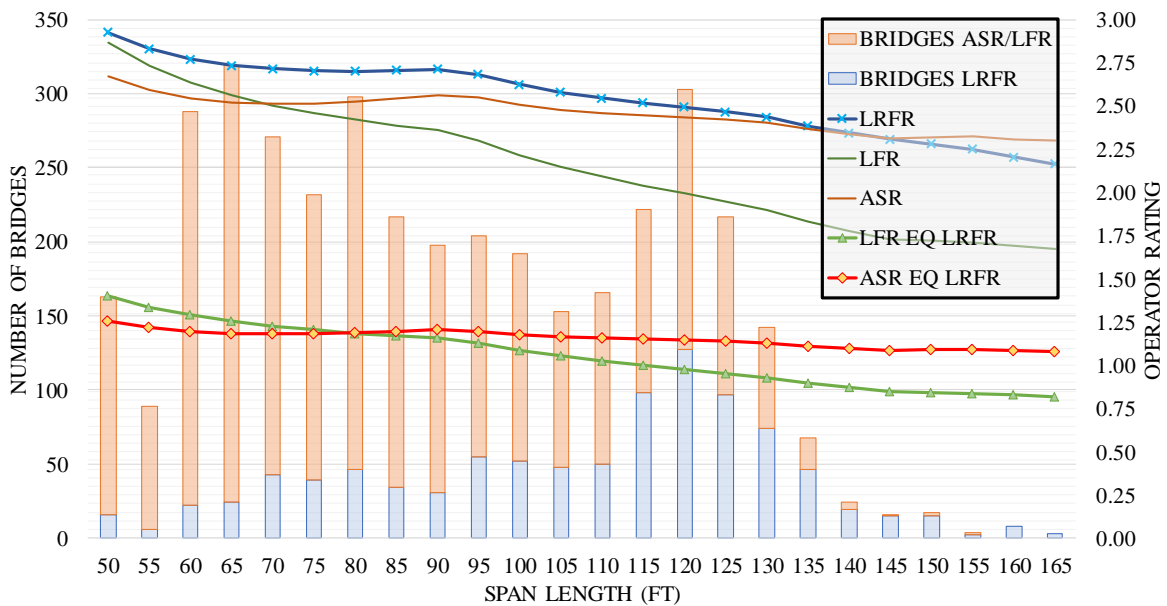
**Table 7.4. Prioritization Categories.**

PM	<0.7	0.7-0.8	0.8-0.9	0.9-1.0	>1.0
Category	5 (High)	4	3	2	1 (Low)

**RESULTS**

This section provides a summary of the load rating and final bridge prioritizations. The presented results convey the impact of (a) original design methodology, (b) bridge span length, (c) truck type, (d) truck spacing, (e) number of trucks within a platoon, and (f) bridge material on the load rating and prioritization. In addition, an Excel tool was developed to provide the full results to TxDOT (explained further below).

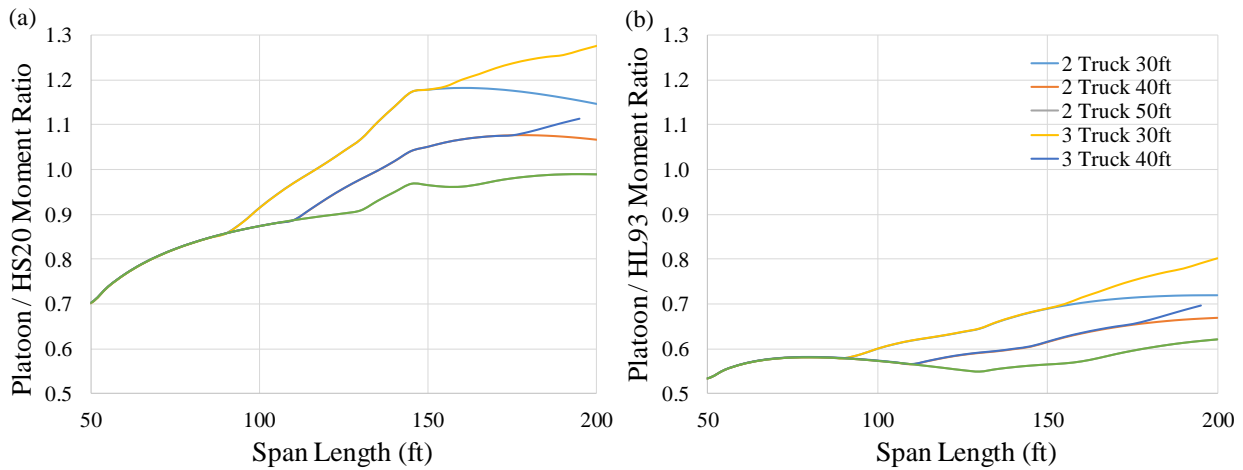
A summary of the bridge load ratings under three-truck platoon loading (Type 3S2) at 30 ft spacing is shown in Figure 7.4 (similar plots were created for the other vehicle platoons and for steel bridges). This figure illustrates the number of concrete bridges under different span lengths, the ORs for all three original design rating methods (ASR, LFR, and LRFR), and the converted equivalent LRFR ratings. It is clearly shown that the load ratings from the original design methods are well above 1.0 (not accounting for bridge condition). However, converting the original ASR and LFR ratings to LRFR does produce OR ratings below 1.0 for certain span lengths. This issue worsens for other truck types since the Type 3S2 is the lightest vehicle evaluated.



Note: EQ = equivalent.

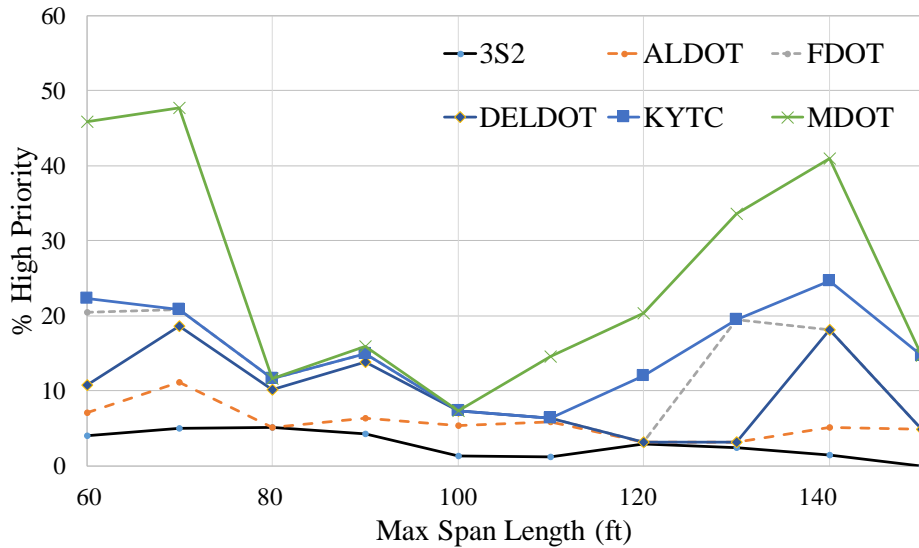
**Figure 7.4. Prestressed Concrete Bridge Comparison for AASHTO Type 3S2 Three-Truck Platoons Spaced at 30 ft.**

The trend of decreasing load ratings with increasing span length makes sense due to the increased magnitude of platoons that can fit on a given span. Figure 7.5 is provided to further illustrate the relative magnitude increase for flexural demand through the ratios of platoon moment (Type 3S2) to AASHTO moments (HS20 and HL93). The figure also shows the relative changes from two-truck to three-truck platoons and the influence of truck spacing. The largest impact can be seen between the design live load models (HS20 versus HL93).



**Figure 7.5. Ratio of Type 3S2 Truck Platoon Moment to the AASHTO (a) HS20 Moment and (b) HL93 Moment.**

The percentage of high-priority (Level 5) bridges was further investigated for the influence of maximum span length. Figure 7.6 provides the results for different truck types. The prioritization results indicate high-priority Texas bridges over a wide array of span lengths due to the influence of condition (from the NBI appraisal values) and the differences in design methodologies.



**Figure 7.6. Percentage of High-Priority (Level 5) Bridges for Different Span Lengths.**

As explained earlier, the converted LRFR ratings for the concrete and steel STRAHNET structures were multiplied by the appraisal rating condition factors in Table 7.3 to prioritize each bridge into one of five prioritization levels (given in Table 7.4). Table 7.5 provides a summary of the results for two-truck platoons spaced at 30 and 40 ft, respectively, for select vehicles. Intuitively, the larger portion of higher-priority bridges results from the shorter-length trucks, which allow for more condensed loading on a structure at one time. Another finding is that with a truck spacing increase from 30 ft to 40 ft, a 14 percent to 33 percent reduction occurs in the Level 5 bridges. This result provides quantitative findings with regard to the influence of truck spacing within platoons.

**Table 7.5. Prioritization Results for Two-Truck Platoons (select vehicles) at 30- and 40-ft Spacing.**

Priority Level	30 ft spacing			40 ft spacing		
	AASHTO 3S2	ALDOT 32S	FDOT C5	AASHTO 3S2	ALDOT 32S	FDOT C5
<b>1 (Low)</b>	3620	2565	1693	4119	2655	1793
<b>2</b>	1382	985	999	1375	1403	1058
<b>3</b>	655	1470	1337	292	1451	1612
<b>4</b>	429	852	1407	353	415	1190
<b>5 (High)</b>	162	376	812	109	324	595

The results do not significantly change between two-truck and three-truck platoons. Table 7.6 conveys this by comparing results for the Type 3S2 platoons (30-ft spacing). It can be seen that



the variation in priority levels ranges from 1 percent to 13 percent. Similar results exist when comparing the two- and three-truck platoons for other truck types. The reason for the limited influence is that the results are heavily influence by the original design methodology and the bridge condition, as indicated earlier. In addition, based on the maximum span length for most of the TxDOT bridge inventory, only two trucks can fit on the majority of the structures. As a result, the number of trucks within a platoon has minimal impact compared to the other parameters.

**Table 7.6. Comparison of Two-Truck versus Three-Truck Results for Type 3S2 Platoons (30-ft Spacing).**

Priority Level	Two-Truck	Three-Truck	% Difference
1 (Low)	3620	3460	4.4%
2	1382	1487	7.6%
3	655	649	0.9%
4	429	483	12.6%
5 (High)	162	169	4.3%

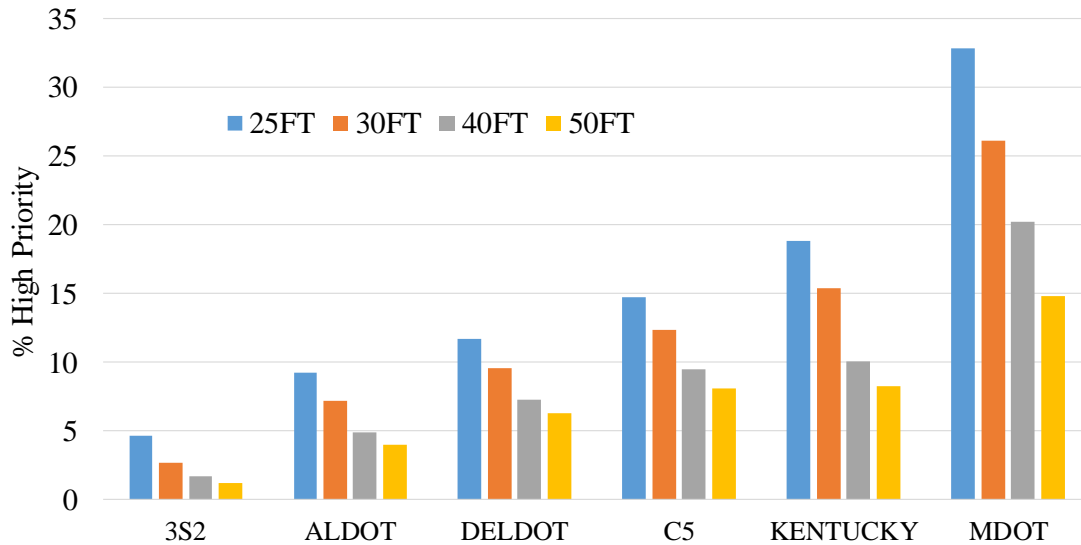
The influence of bridge material was also investigated. The prioritization results for different vehicles were compared for the concrete and steel bridges. Table 7.7 presents the results for select vehicles in terms of the percentage of all concrete or steel bridges to allow for a true comparison. Minimal variations are observed, indicating bridge material has little impact on the prioritization results.

**Table 7.7. Prioritization Results Comparison between Concrete and Steel Bridges.**

Priority Level	Two-Truck Platoons at 40 feet Spacing					
	Steel			Concrete		
	AASHTO 3S2	ALDOT 32S	FDOT C5	AASHTO 3S2	ALDOT 32S	FDOT C5
<b>1 (Low)</b>	63%	46%	43%	67%	41%	24%
<b>2</b>	28%	17%	8%	20%	24%	20%
<b>3</b>	2%	28%	20%	6%	22%	28%
<b>4</b>	7%	2%	22%	5%	8%	18%
<b>5 (High)</b>	1%	7%	8%	2%	5%	10%

To graphically illustrate the variation in results for different truck types and truck spacing, the percentage of high-priority (Level 5) bridges are provided in Figure 7.7. The truck spacing was

expanded to include a range of 20 to 50 ft. This illustration clearly conveys the significant impact truck type and truck spacing have on the prioritization results.



**Figure 7.7. Percentage of High-Priority (Level 5) Bridges for Different Truck Types and Truck Spacing.**

An Excel tool was developed using Visual Basic programming and submitted separately to provide TxDOT with the full bridge results. This tool conveys the results for different truck platoon configurations. The user selects the following:

- Number of trucks.
- Truck spacing.
- Truck type.
- TxDOT district.
- Output type (all or just high priority).

The corresponding bridge information appears when the program is executed. The pertinent bridge information (e.g., bridge number, span length, year built, bridge type, etc.) is provided along with the estimated OR, priority rating (PM values explained above), and final prioritization level.

## FINDINGS

This study prioritized the applicable concrete and steel girder bridges within Texas for future truck platoon loading through a comprehensive study of the NBI database combined with a substantial literature review. The information was utilized to make assumptions so that truck platoon load ratings could be calculated for the concrete bridges likely to foresee platoons (over

6,000 bridges). The prioritization incorporated the bridge condition through the NBI structural evaluation appraisal ratings. The combined information was categorized from low to high-priority bridges. As a result, the study was able to provide a ranking of bridges to allow TxDOT the ability to prioritize the structures that should receive the earliest attention.

Additional general conclusions from the study for concrete and steel girder bridges supporting future truck platoons include:

- The original design methodology of the bridge has a significant impact on its ability to support future truck platoon loading. Bridges designed using the LRFD method can be likely classified low priority for further evaluation of future truck platoon loading unless the condition of the structure is poor because HL-93 live loading adequately encompasses the typical truck platoon configurations. However, bridges designed using LFD/ASD methods may require further evaluation for future truck platoon loading, particularly for longer spans and/or poor condition.
- The spacing between trucks within a platoon can have a large impact on the demands imposed on bridges, thus affecting those structures to be upgraded. The results of this study showed up to a 33 percent increase in high-priority (Level 5) bridges when reducing the truck spacing from 40 to 30 ft.
- The truck type (axle weights and spacing) used for future platoons will also significantly influence the demands imposed on bridges. For example, truck platoons made up of lighter/longer AASHTO Type 3S2 trucks will have much less of an impact than heavier/shorter MDOT HS-Short trucks.
- The number of trucks within a platoon was found to have lesser impact. The only exception is for long-span structures, which need to be evaluated on an individual basis. For the TxDOT bridge inventory, the prioritization results for two-truck platoons were nearly the same as for three-truck platoons.
- The bridge material was also found to have minimal impact. There are more high-priority concrete bridges simply because there are more concrete bridges in the state. However, the percentage of high-priority steel and concrete bridges are similar.



## **CHAPTER 8. IMPACTS OF TRUCK PLATOONING AND TRUCK AUTOMATION ON THE VULNERABILITY OF THE TEXAS HIGHWAY SYSTEM**

### **OBJECTIVE**

In Task 5 of the project, impacts of the truck platooning and truck automation on the overall vulnerability of the Texas Freight Network were examined. The methodology consisted of first modeling the Texas Highway Freight Network with a novel, graph-based network model framework comprised of pavement sections and bridges and then conducting a network-level vulnerability analysis of the freight network pavements and bridges.

### **THE IMPACTS OF TRUCK PLATOONING ON THE VULNERABILITY OF TEXAS PAVEMENTS**

Because of the large number of pavement sections in the Texas Highway Freight Network, the analysis of pavement vulnerability was based on detailed performance data from the FHWA LTPP pavements in Texas. The results from an analysis of the LTPP pavements were then extrapolated to the whole Texas Highway Freight Network based on equivalent AADTT, road type, and pavement type. Corresponding performance indicators for each pavement type were used to estimate the difference in the remaining service life of the pavements under a truck automation and platooning scenario versus a normal truck traffic scenario. Rutting, TDC, and BUC were studied for flexible pavements. Depending on the type of rigid (concrete) pavement, examples of performance indicators included fatigue cracking and punchout progression. In the case of flexible pavements, a 22 percent reduction in average service life was observed for TDC, and a 21 percent reduction in average service life was observed for BUC, compared to only a 9 percent reduction in average service life for rutting.

The analysis was not only able to estimate the reduction in service life (RSL) due to truck automation but also able to identify the pavement sections with the greatest decreases in pavement life. Therefore, the analysis results can serve as a basis for identifying which pavement sections to harden as well as help evaluate different hardening options. To that end, two possible pavement hardening scenarios—(a) building dedicated truck lanes, and (b) hardened, paved surfaces using polymer-modified asphalts—were proposed. The analysis of hardening options also specifically examined the impacts of different levels of polymer modification on improving the service life of the pavements. Initial results showed that 3–6 percent polymer modification of the asphalt binder can reduce the negative impacts of truck automation on all types of premature asphalt pavement degradation, with the upper range of polymer modification resulting in total negation of all negative effects on cracking and rutting.

## **Policy, Planning, and Investment Implications**

The policy, planning, and investment implications of the pavement network analysis include:

- Under truck platooning, all key flexible pavement failure types are accelerated.
- Introducing dedicated hardened freight routes and/or truck lanes should be considered as options.
- The negative impact on TDC pavement service life is the greatest. Specific hardening actions that improve the cracking life of flexible pavements on key truck routes, including polymer modification, can improve the service life of pavements.
- Since the RSL for the jointed reinforced concrete pavement (JRCP) is greatest, TxDOT may consider not using this type of construction on future autonomous/platoon truck highway lanes.
- Results show that all modes of failure are diminished with the introduction of high polymer-modified asphalt (HPMA). Therefore, introducing dedicated truck lanes on key routes using polymer-modified asphalt concrete is a viable option to minimize or fully negate the adverse effects of autonomous truck traffic on the Texas Highway Freight Network.

Importantly, the controlling factor in the reduction in pavement service life for all pavement types was the reduction in WW due to the introduction of truck automation. WW occurs naturally with human drivers due to the inability to steer continuously an exact distance from the edge of the pavement. The computer control systems used by truck automation companies enable very precise control of the distance of the outer truck axles with respect to the edge of the pavement. Thus, TxDOT may want to consider specifying how much WW should be required by truck automation and platoon truck companies in order to negate the negative effects of truck automation on the service life of Texas Freight Network pavements.

## **THE IMPACTS OF TRUCK PLATOONING ON THE VULNERABILITY OF TEXAS HIGHWAY BRIDGES**

Out of more than 55,000 bridges in Texas, this study identified about 20,000 bridges in the Texas Highway Freight Network for inclusion in this study. First, a bridge prioritization study was completed. A comprehensive index entitled Priority Rating (PR) for the overall condition of the bridges was used to quantify each bridge's ability to support truck platoons. A Microsoft Excel tool was developed to conveniently identify bridges that need attention at different spatial scales. The overall impact of platooning was assessed using two different methods: (a) using the key performance indicators (PR) for the bridges; and (b) using full Texas Freight Network-level analysis. The main findings of the bridge vulnerability study included:

- **Truck gap spacing** had a moderate impact on bridge vulnerability. For example, there was a 33% increase in the number of high-priority bridges when truck spacing was reduced from 40 to 30 ft.
- **The number of trucks** in a platoon had a minor impact. An exception to this finding is very long-span structures in poor condition.
- **Bridge material** (steel versus concrete) has a minor impact, while the bridge generation (i.e., the generation of the building code used to design the bridge) has a significant impact on bridge vulnerability; older bridges designed with building codes prior to the introduction of LRFD methodology are more susceptible to negative impacts from truck automation and platooning.

### **Policy, Planning, and Investment Implications**

Policy, planning, and investment implications of the bridge vulnerability analysis include:

- Some truck platoon configurations with close axle spacings—for example, three C5 trucks at 30-ft spacing—have a higher negative impact on bridges than others. TxDOT may want to consider specifying a minimum of 50-ft truck spacing in platoon truck configurations to minimize the impact on Texas bridges.
- Introducing guidelines for platoon truck weight distributions may be a way to reduce this impact.
- The results show that network-level analysis tools can be used effectively to assess future platooning configuration policies.

### **OTHER KEY PROJECT FINDINGS AFFECTING POLICY AND PLANNING**

The results from the traffic simulation research in Task 4 include the following policy and planning implications:

- **Lane Restriction Policy:** Restricting platooning trucks to the right lane adversely affects freeway performance. Platoons should not be restricted to right lanes only.
- **Traffic Volume Levels:** Corridors with LOS-C or better are best suited for testing platooning. Therefore, initial testing of truck platoons should occur in more rural areas.
- **Lane Change Policy:** The results show that platoons should not be required to move left when approaching a ramp. This maneuver creates unnecessary lane changing at low-volume levels. The results also showed that cooperative lane changing by platoon trucks to accommodate merging vehicles did not improve freeway performance.
- **Auxiliary Lane and Weaving Section Considerations:** Auxiliary lanes tend to improve freeway performance in the truck platooning environment. Therefore, it is preferable to select corridors that provide an auxiliary lane for the ramps. Weaving length is the deterring factor when selecting a corridor for truck platooning. Thus, it is preferable to select corridors with weaving sections that are greater than 1,000 ft in length.

## HIGH-LEVEL OBJECTIVE AND MOTIVATION

The objective of this task was to examine the impact of truck platooning and truck automation on the vulnerability of the Texas highway freight system. To this end, the research team first built a fast, graph-based model in which different pavement sections and bridges in the Texas highway freight system were modeled as nodes, and their connection was modeled as links. In the second step, the researchers used the outcomes from Task 4 related to quantified degradation and damage of pavement sections and bridges due to truck platooning and truck automation together with the graph-based model to simulate the likelihood of disruptions in different nodes (e.g., major pavement damage or structural bridge damage). Thus, the researchers evaluated how truck automation and platooning impacts and influences the vulnerability of Texas highway networks. In this context, vulnerability is defined as the susceptibility of Texas highway networks to truck platooning and truck automation impacts. Based on the network analysis, the researchers classified pavement sections, pavement types, and bridges based on different levels of vulnerability for the prioritization of truck platooning corridors. The results served as inputs for the economic analysis in Task 6 to quantify the network-level economic benefits and costs of truck platooning under different scenarios.

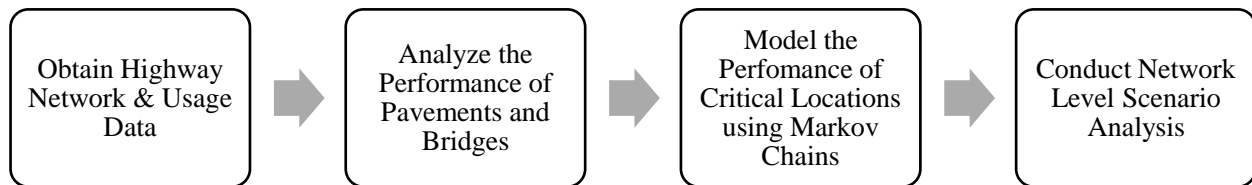
This study employed a four-step graph, theory-based network framework to model the impact of truck automation and truck platooning on the vulnerability of the Texas freight highway network. First, the researchers modeled the highway system as a primal graph in which nodes represent intersections and edges represent highway sections. This network abstraction of the highway system facilitated the identification of different levels of vulnerability for the pavement sections and bridges included in the study. Then, with the help of corresponding models that capture the temporal changes of the main performance indicators of the bridge and pavement sections in the freight network, a temporal level of service (based on network connectivity) measure for the overall network was obtained using a new Markov chain method. This approach was able to quantify the network-level changes in both bridge and pavement vulnerability due to the introduction of automated and platoon trucks. In this context, pavement vulnerability was quantified in terms of changes in service life, whereas bridge vulnerability was quantified in terms of changes in a bridge's performance rating. Finally, the benefits of different freight highway hardening options were assessed using a scenario analysis. The proposed method was demonstrated using the network topology and demand (AADTT) data provided by TxDOT for the freight highway network in Texas. It was found that the stochastic modeling of the highway network performance using the Markov chain-based approach enabled not only the examination of the impact of a wide spectrum of factors but also the system-level management and optimization of highway network performance. The Markov chain method used in this study allowed for efficient and fast characterization of the vulnerability of the Texas Highway Freight Network due to the introduction of automated and platoon truck technologies by modeling and quantifying the transitions of the condition status for the bridge and pavement sections. The transition matrix from one condition state to another was estimated using the historical temporal



condition transition data for the bridge and pavement sections under different scenarios, which then was used to quantify the impacts of different scenarios on the individual performance indicators. Results and findings of this study can inform strategy, planning, policy, and investment decisions pertaining to the implementation of truck automation and truck platooning, as well as provide a rigorous framework for quantifying the benefits of different hardening actions on the freight network.

## METHODOLOGY FRAMEWORK

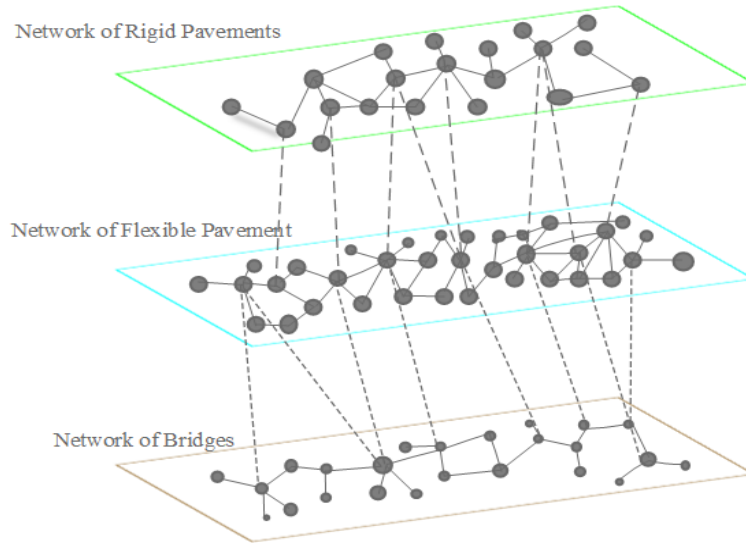
Figure 8.1 shows the modeling framework used to assess the vulnerability of the Texas Highway Freight Network due to the introduction of automated and platoon trucks. The developed modeling framework has two underpinning components that complement each other. One is a graph-based vulnerability assessment method that is capable of efficiently assessing the vulnerability of the freight network at multiple spatial scales under various scenarios. The other one is a Markov transition-based approach that is used for quantifying the effects of various scenarios associated with automated and platoon truck configurations, such as WW effects, platoon truck spacing, and axle configurations. This approach was also used to quantify the benefits of different infrastructure hardening scenarios. The steps and summary of the methods used in this framework are presented in Figure 8.1.



**Figure 8.1. Modeling Methodology Used to Quantify Network Vulnerability.**

### Graph-Based Framework for Assessing Transportation Network Vulnerability

The fast, graph-based network analysis included a network-of-network model of the Texas Highway Freight Network components, such as different types of pavements (flexible and rigid) and bridges, as can be seen in Figure 8.2. With the help of topological centrality measures for individual nodes or robustness metrics for the whole network, this framework is able to (a) identify critical locations that are essential to the integrity of the network; and (b) compare the robustness of the network against a wide spectrum of stressor scenarios (i.e., new load configurations due to truck platooning) at various spatial scales (individual neighborhood, city, county, or state).



**Figure 8.2. Network-of-Network Representation of Freight Network Components.**

Due to the topological configurations of the Texas Highway Freight Network, each component in the network plays its respective role in ensuring the integrity of the network. Therefore, the location of disruptions (due to component failure) on the road network matters significantly for the connectivity of the network. When a certain pavement or bridge is closed (due to construction, maintenance, rehabilitation, etc.), its impact on the network connectivity is different across the network. By conducting simulations that remove each bridge or pavement section temporarily from service, it is possible to identify sections that are more critical to keeping the functionality of the network at a certain threshold value. The ratio of the size of the original network and the size of the giant component of the network (i.e., network remaining after certain nodes or road sections are removed from service in this manner) has been used to quantify the impact of disruptions on the network (107):

$$C = \frac{S_{GS}}{S_0} \quad (8.1)$$

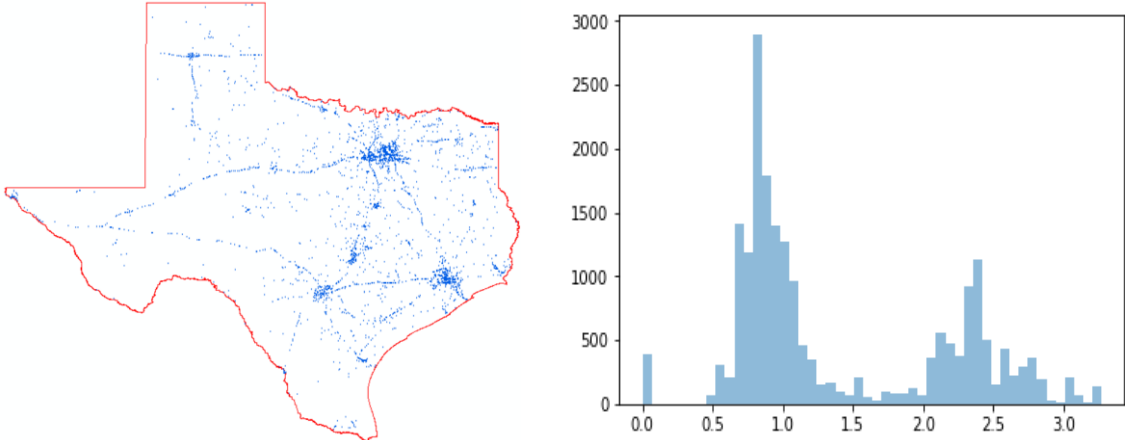
where

- $C$  : connectivity of the network;
- $S_{GS}$  : the size of the giant component after disruption; and
- $S_0$  : size of the original network.

### **Application of Graph-Based Framework for Bridge Vulnerability Analysis**

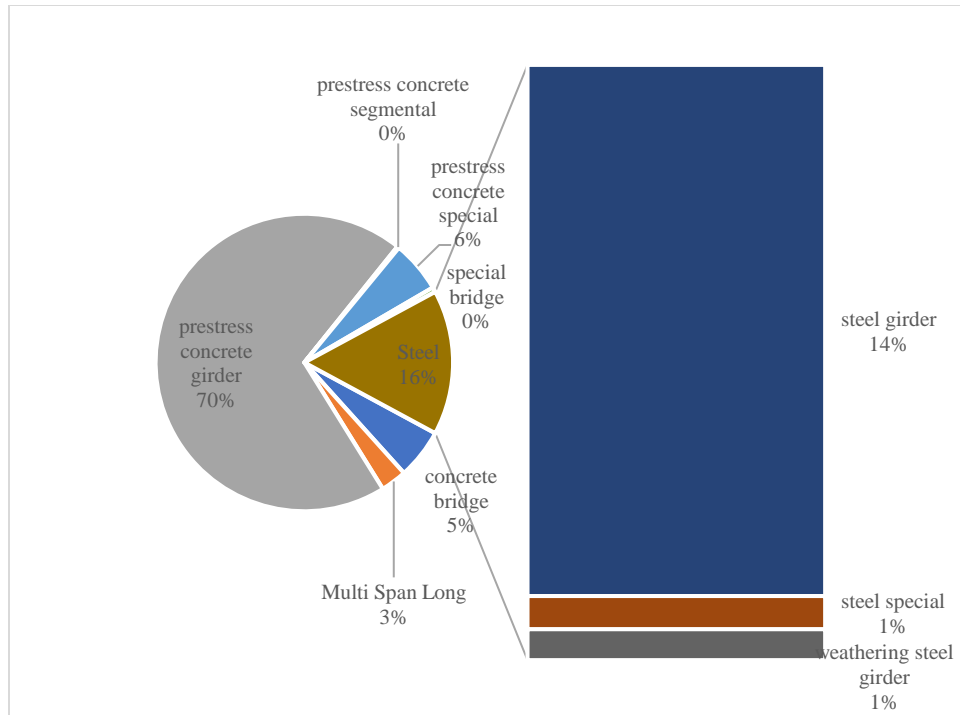
The graph-based framework was used to identify bridges and assess bridges in the Texas Highway Freight Network that might benefit from maintenance or rehabilitation due to the introduction of truck platooning. The reference platoon truck configuration used was based on

two standard AASHTO trucks (3S2) with 50 ft spacing since this configuration did not result in significant damage beyond the current normal non-automated truck traffic. The NBI database lists over 55,000 bridges in the Texas highway network. Out of that, 20,922 bridges are a part of the Texas Highway Freight Network and have a span length of at least 45 ft, which is the minimum length needed to accommodate two trucks in a platoon. A further 591 bridges were excluded because they fell outside the assumptions of the analysis. In total, 20,331 bridges were considered in this report (Figure 8.3). A PR system was used to classify the bridges and to develop recommendations for which bridges would benefit the most from rehabilitation hardening. A histogram of the PR for the selected bridges is given in Figure 8.3.



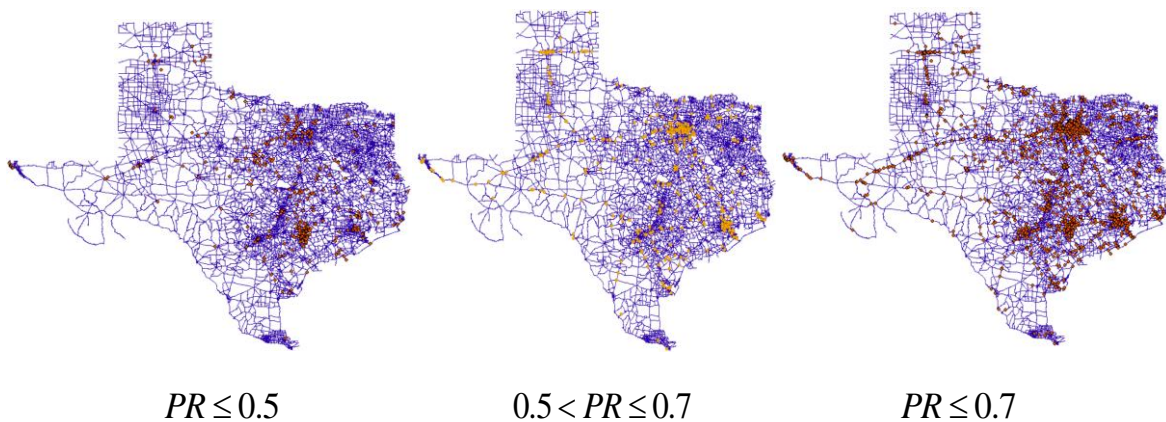
**Figure 8.3. Locations of Bridges and Priority Rating under One Platooning Scenario (2 3S2 trucks at 50 ft).**

The bridges examined in this study can be divided into various types (Figure 8.4).



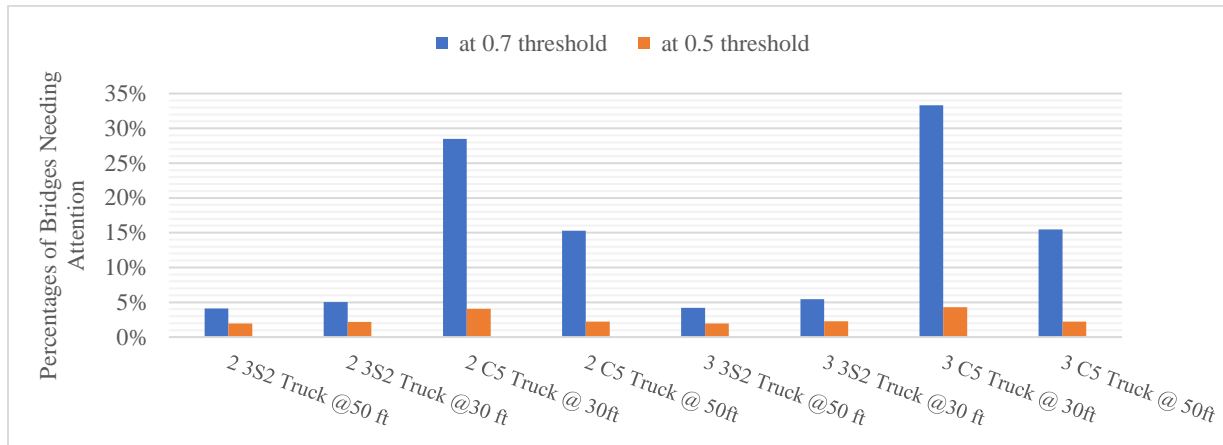
**Figure 8.4. Texas Freight Network Bridge Classification.**

The PR is a comprehensive condition rating measure proposed by our research team members for the bridges in the Texas Highway Freight Network. It refers to the OR of the bridge converted to the LRFR method (for ASR and LFR results) and then adjusted for bridge condition using the inspection appraisal ratings. When a rehabilitation threshold of  $PR = 0.5$  or less is used, 394 bridges can be identified as benefitting from rehabilitation when a platooning scenario of two 3S2 trucks spaced at 50 ft is implemented. They are presented on the map on the left in Figure 8.5. When  $PR = 0.7$  or less is used, the number of bridges becomes 835, and they are presented in the map on the right (Figure 8.5).



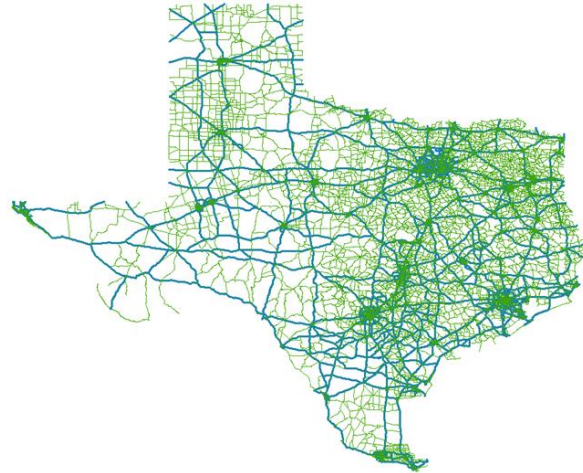
**Figure 8.5. Bridges that May Benefit from Attention at Different PR Threshold.**

Similarly, for all possible truck platoon scenarios, the percentage of the bridges that need attention when implementing the corresponding platooning scenario are shown in Figure 8.6 for both PR thresholds of 0.5 and 0.7. There are obvious differences in the number of bridges that may benefit from extra attention under different scenarios. Two 3S2 trucks at a 50-ft spacing scenario require the smallest number of bridges being attended to, while three C5 trucks at a 30-ft spacing scenario require attention for the largest number of bridges.



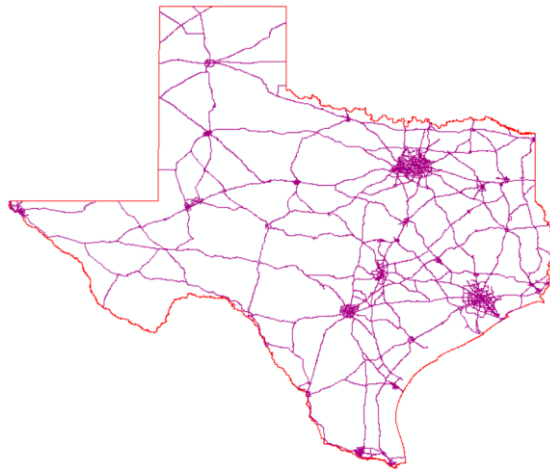
**Figure 8.6. Percentage of Bridges in Possible Need of Attention.**

Similarly, bridges that may need attention (additional maintenance or rehabilitation) when a corresponding platooning scenario is introduced can be identified by proposing a comprehensive priority index (on a scale of 1 through 5, with a higher value meaning the bridge may need closer attention). For example, bridges with Priority Index 5 might be chosen for hardening. A priority index of 5 corresponds to the PR of 0.7 (see Figure 8.5). The impact of road closure activity due to maintenance or rehabilitation on the network can be assessed using a graph-based approach with different levels of granularity, as shown in Figure 8.7. When one of the truck platooning scenarios is implemented throughout the network, a corresponding number of bridges fall into the respective prioritization categories. This study analyzed the impacts of rehabilitating bridges in Categories 1, 2, 3, 4, and 5, respectively, on the connectivity of the network, which was also translated to a corresponding PR.



**Figure 8.7. Texas Freight Network at Two Levels of Granularity (Green—Detailed, Blue—Major Roads).**

A significantly smaller number of pavement sections and nodes in the Texas Freight Network (Figure 8.8) are classified as major arterial roads (IH, US highway systems). The results for the graph-based connectivity analysis are presented in Table 8.1.

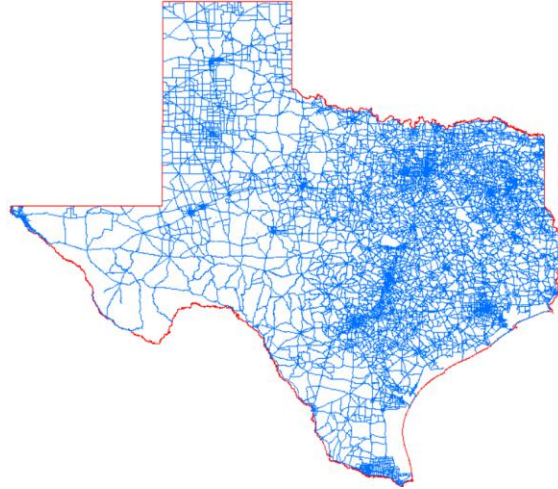


**Figure 8.8. Major Arterial Roads on the Texas Freight Network.**

**Table 8.1. Connectivity of Major Arterial Highway Network under Different Bridge Condition Scenarios.**

Condition Category	Number of Bridges	Number of Edges Impacted	Connectivity After Removal of Edges
1	623	329	2.0%
2	1150	527	1.5%
3	1507	612	1.1%
4	1152	493	1.7%
5	1805	555	1.1%

In comparison, a greater number of pavement sections and nodes are in the detailed Texas Freight Network (Figure 8.9). The results for the graph-based connectivity analysis are presented in Table 8.2. The connectivity of the Texas Freight Network consists of major roads that are more vulnerable to the closure of the roads.



**Figure 8.9. Detailed Texas Freight Network.**

**Table 8.2. Connectivity of Detailed Freight Network under Different Condition Scenarios.**

Condition Category	Number of Bridges	Number of Edges Impacted	Connectivity After Removal of Edges
5	623	545	92.2%
4	1150	954	89.6%
3	1507	1225	82.8%
2	1152	904	87.0%
1	1805	1405	85.6%

### **Modeling Transition from Regular Truck Traffic to Automated and Platoon Truck Traffic**

A Markov transition matrix-based approach was developed and implemented for modeling and quantifying the temporal performance of freight network components for both the pavement sections and bridges. In this system, the researchers considered there to be  $m$  number of performance indicators (for example, rutting, BUC, and TDC for AC pavements) and  $n$  number of independent observations (flexible pavements, rigid pavements, bridges). For a certain type of freight network asset (bridges or pavements), the condition matrix at a given time (and given condition)  $i$  constitutes a  $n \times m$  matrix that can be used to quantify the impacts of transitioning from one state to another, namely:

$$C_i = \begin{bmatrix} c_{11} & \cdots & c_{1m} \\ \vdots & \ddots & \vdots \\ c_{n1} & \cdots & c_{nm} \end{bmatrix} \quad (8.2)$$

A transition matrix ( $m \times m$ ) is proposed for the above condition matrix, if we consider the transition matrix for the pavement sections at a certain given time period is as follows:

$$T_i = \begin{bmatrix} t_{11} & \cdots & t_{1m} \\ \vdots & \ddots & \vdots \\ t_{m1} & \cdots & t_{mm} \end{bmatrix} \quad (8.3)$$

If the condition of the pavements at a given point in time is multiplied by the transition matrix at the corresponding time, the result will be the condition for the next point in time,  $C_i T_i = C_{i+1}$ , which can be written as:

$$\begin{bmatrix} c_{11} & \cdots & c_{1m} \\ \vdots & \ddots & \vdots \\ c_{m1} & \cdots & c_{mm} \end{bmatrix} \begin{bmatrix} t_{11} & \cdots & t_{1m} \\ \vdots & \ddots & \vdots \\ t_{m1} & \cdots & t_{mm} \end{bmatrix} = \begin{bmatrix} c_{11} & \cdots & c_{1m} \\ \vdots & \ddots & \vdots \\ c_{m1} & \cdots & c_{mm} \end{bmatrix} \quad (8.4)$$

where  $C_i$ : condition at a given time; and  $T_i$ : transition matrix at a given time.

The above equation can be used to solve for the transition matrix:

$$T = [C_i^T C_i]^{-1} [C_i^T C_{i+1}] \quad (8.5)$$

The transition matrix approach can be used to model and monitor the performance of any given network asset, temporally as well as under different scenarios. Its application is demonstrated separately for modeling the performance of pavements and bridges. The eigenvalues and eigenvectors of the transition matrix are important since they help identify and quantify the sources of changes in the assets under different scenarios. For example, by ranking the eigenvalues of the transition matrix, it is possible to identify the performance indicator that has the most significant change in asset performance, which in turn can be used to quantify the impact on the individual performance indicator. If comparing scenarios, the average of the eigenvalues corresponding to the respective scenarios can reveal the scenario in which the performance indicator is highly impacted.

## **Demonstration of Markov Transition-Based Modeling Framework**

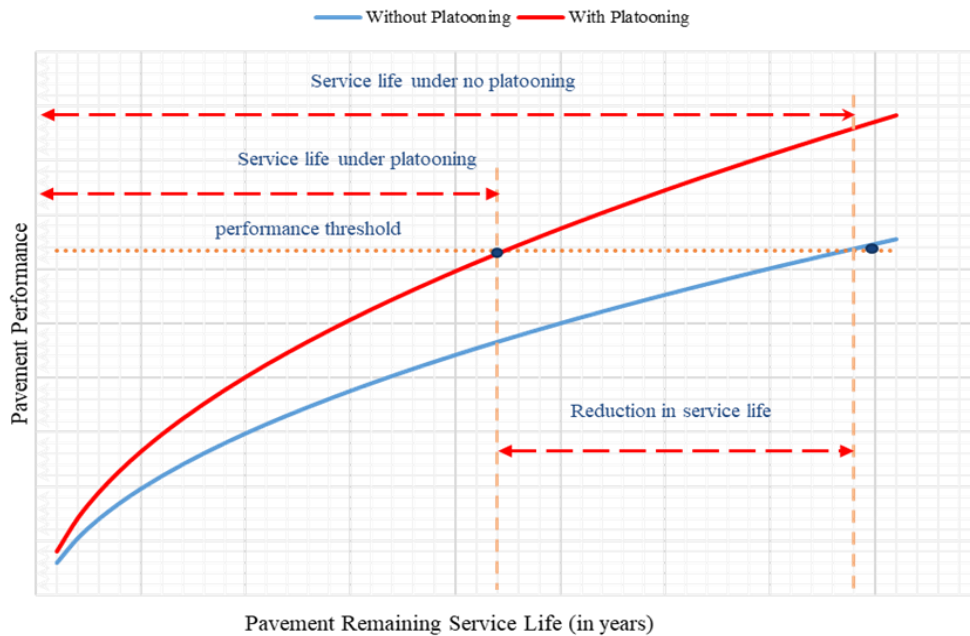
### *Vulnerability Analysis of Pavements*

With time, as can be seen from a typical condition deterioration profile (Figure 8.10), the condition of network components (pavements or bridges) deteriorates at an increasing rate. This phenomenon can be quantified through the changes in the service life of both pavements and bridges due to different truck automation and platooning scenarios. The results can also be used



to identify which pavement sections or bridges result in the fastest deterioration due to any given truck automation or platooning scenario, and therefore identify which assets will benefit the most from rehabilitation. Using the detailed historical condition records ( $C_i$ ) for components of the freight network (bridge and pavement sections), the transition matrix ( $T_i$ ) for each component in the network can be trained and calibrated. Thus, the condition status for each component at any point (A) in the future (or a given scenario) can be estimated using  $C_{i+1} = C_i T_i$ . Next, the future condition status can be used as an input for estimating the remaining useful service life (RUL) of the bridges or pavements.

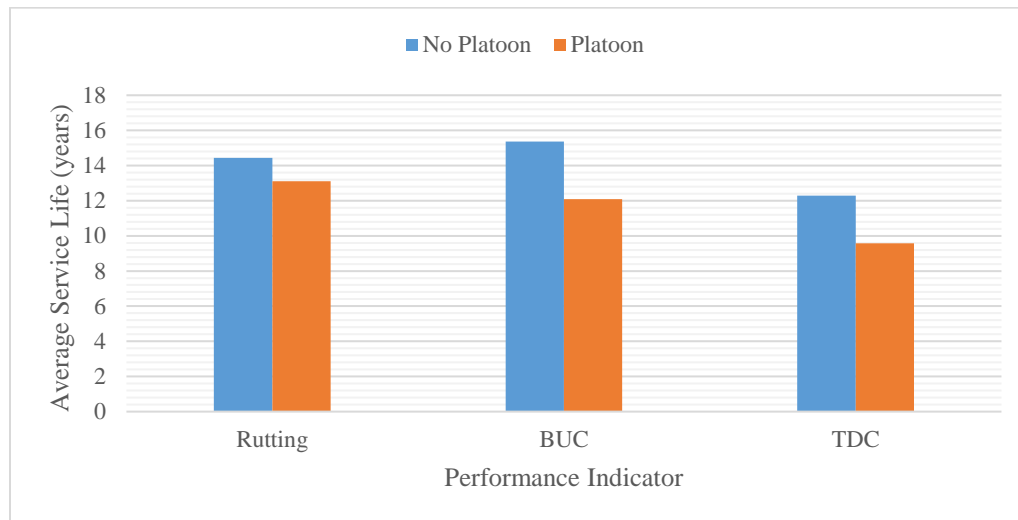
This section focuses first on flexible pavements, followed by concrete pavements. The researchers applied the Markov chain-based framework using estimated service life for flexible pavements based on three different performance indicators, namely rutting, BUC, and TDC.



**Figure 8.10. Pavement Useful Service Life (RUL) Estimation.**

**The transition from normal truck traffic to a full truck platoon scenario:** If three performance indicators (for example, rutting, TDC, and BUC for flexible pavements) and 22 independent observations (number of flexible pavements sections this study examined) are considered, the condition matrix under a given scenario constitutes a  $22 \times 3$  matrix that is used to build the transition matrix. Thus, Markov condition matrices under truck platoon and non-platoon scenarios were used to calculate the transition matrix. The eigenvalues for all three types of pavement deterioration (rutting, TDC, and BUC) were decreased, meaning that all three deterioration types will be accelerated with the introduction of automated and platoon trucks. The TDC and BUC performance indicators showed the greatest decrease in eigenvalues, meaning that both TDC and BUC will be more prevalent after the introduction of automated and

platoon trucks. The comparison of the decrease in service life under these two scenarios is shown in Figure 8.11.



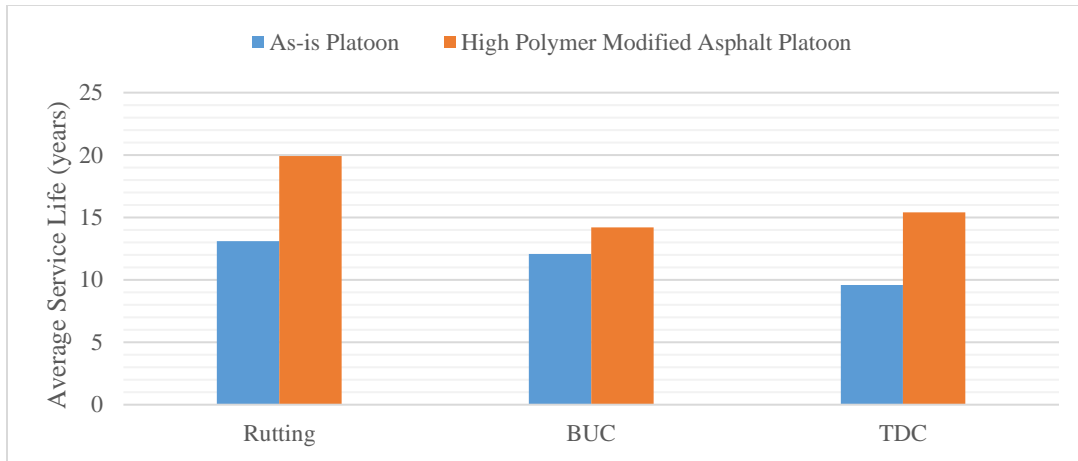
**Figure 8.11. Flexible Pavement Service Life under Normal and Full Platoon Scenarios.**

### Hardening Options for Pavements

The researchers proposed two hardening options for the pavements in order to cope with the negative impacts caused by the truck platooning:

- **Introducing dedicated truck lanes** enables minimizing or avoiding building excess capacity because a dedicated lane can be custom-built for the trucks.
- **Using polymer-modified asphalt** can improve the durability of the pavements because it enhances pavement resistance to both rutting and cracking.

One of the strategies to decrease the rate of deterioration (including rutting and cracking) of pavements after the introduction of automated and platoon trucks is to use polymer-modified asphalt (PMA) pavements to increase service life. For example, for the pavement section (#1076) from the FHWA LTPP study in Texas, if the rutting rate is decreased by 50 percent through the use of HPMA, the service life of the pavement will not decrease. In fact, the service life will be even longer than the base-case scenario in which no truck platoon is implemented. A comparison of the service life under normal platooning and platooning under HPMA pavement can be seen in Figure 8.12.



**Figure 8.12. Flexible Pavement Service Life under Full Platoon and HPMA Scenario.**

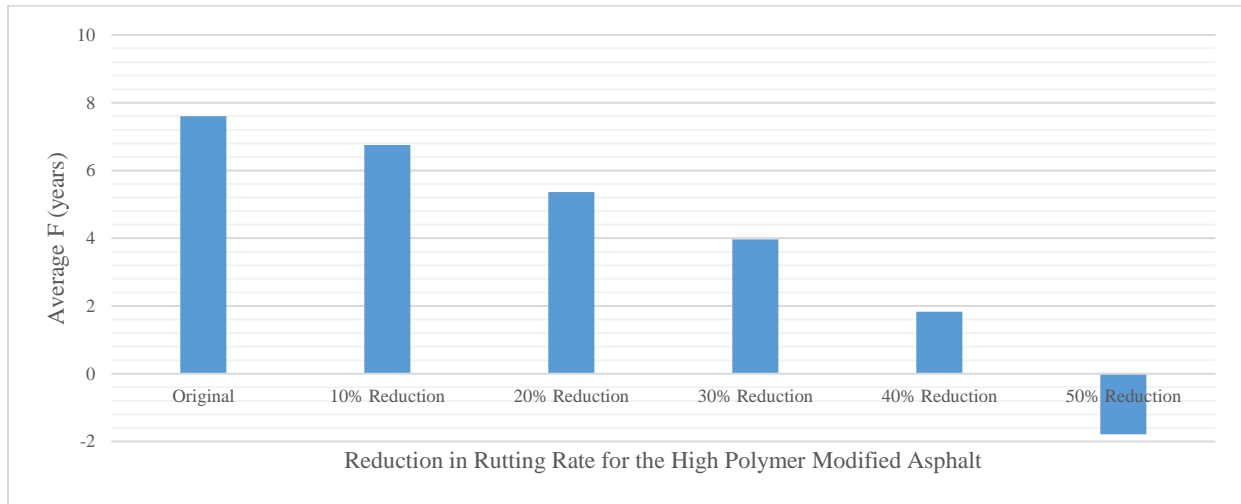
As can be observed in Table 8.3, under the first transition (no platoon → full platoon), eigenvectors corresponding to TDC and BUC have the same low eigenvalues, which indicates the overall impact of platooning on TDC and BUC indicators is relatively greater, meaning that cracking increases and will become relatively more severe than rutting. Under the second transition (full platoon → platoon with HPMA pavement), which moves from a relatively severe state to an improved state, rutting and BUC have the same low eigenvalues, which indicates the overall impact of HPMA on rutting and BUC is relatively greater, but all three types of degradation will be reduced by the introduction of HPMA.

**Table 8.3. Summary of the Pavement Transition Matrix under Different Scenarios.**

Scenarios	Transition Matrix	Eigenvalues
non-platoon → full platoon scenario	$\begin{bmatrix} 1.01 & 0.14 & 0.138 \\ 0.01 & 1.228 & 0.77 \\ 0.09 & -0.48 & 0.05 \end{bmatrix}$	$[0.97 + 0.j \quad 0.669 + 0.16j \quad 0.669 - 0.16j]$
full platoon scenario → HPMA	$\begin{bmatrix} 0.40 & 0.125 & 0.05 \\ -1.338 & -0.66 & -0.56 \\ 2.00 & 1.61 & 1.52 \end{bmatrix}$	$[0.13 + 0.03j \quad 0.13 - 0.036j \quad 0.99 + 0j]$

The level of reduction in the service life of the flexible pavements when HPMA pavement is used depends on the level of modification in the polymers. A higher level of polymer modification can significantly decrease the rate at which rutting or cracking develops in the asphalt pavements. This study conducted a sensitivity analysis for the reduction in rutting rates and its impacts on the average RSL in the 22 flexible pavements under the LTPP. For example, as the rutting rate is decreased by 10 to 50 percent through the addition of different amounts of polymer modification, the improvements in the RSL become increasingly evident. Initial results show a polymer modification resulting in a 40 to 50 percent decrease in the rate of rutting can offset the negative impacts caused by truck platooning on the service life of the pavements for

rutting (see Figure 8.13). Similar improvements in cracking resistance can also be observed, as shown previously in Figure 8.12.



**Figure 8.13. Average RSL under Different Levels of Modifications.**

#### *Vulnerability Analysis on Texas Bridges*

Two common types of five-axle trucks were considered for truck platooning—the 3S2 and C5—with the differences between these truck configurations primarily being that the C5 trucks had closer axle spacing than the 3S2 trucks, resulting in more severe bridge loading conditions on bridges with longer span lengths. As for the number of trucks in the platoon, only two- and three-truck scenarios were considered since they are the most likely. For the spacing ( $S_a$ ) between the trucks in the platoon, two scenarios, 30 ft, and 50 ft, were considered. Thus, eight scenarios exist in total. Since the two 3S2 truck platooning at 50-ft scenario is closest to the business-as-usual scenario, the researchers considered it the base-case scenario, thus allowing the creation of a corresponding transition matrix for each of the seven transition scenarios.

**Table 8.4. Possible Transition Scenarios for the Bridges in Texas Freight Network.**

Transition from	Transition to
Base-case scenario	2 3S2 30-ft spacing
Base-case scenario	2 C5 30-ft spacing
Base-case scenario	2 C5 50-ft spacing
Base-case scenario	3 3S2 30-ft spacing
Base-case scenario	3 3S2 50-ft spacing
Base-case scenario	3 C5 30-ft spacing
Base-case scenario	3 C5 50-ft spacing

Three performance indicators were chosen for the bridges, which were OR, LRFR, and net rating. For 20,331 bridges in the Texas Freight Network, a  $20,331 \times 3$  matrix exists for every

truck platooning scenario. In order to compare results under the normalized and raw-data scenario, in one category, the data were normalized using the following equation:

$$NC_i = C_i / \max(C_i) \quad (8.6)$$

where

$NC_i$ : normalized condition rating;

$C_i$ : the original condition rating for the bridges; and

$\max(C_i)$ : the maximum value in the data for the bridge rating.

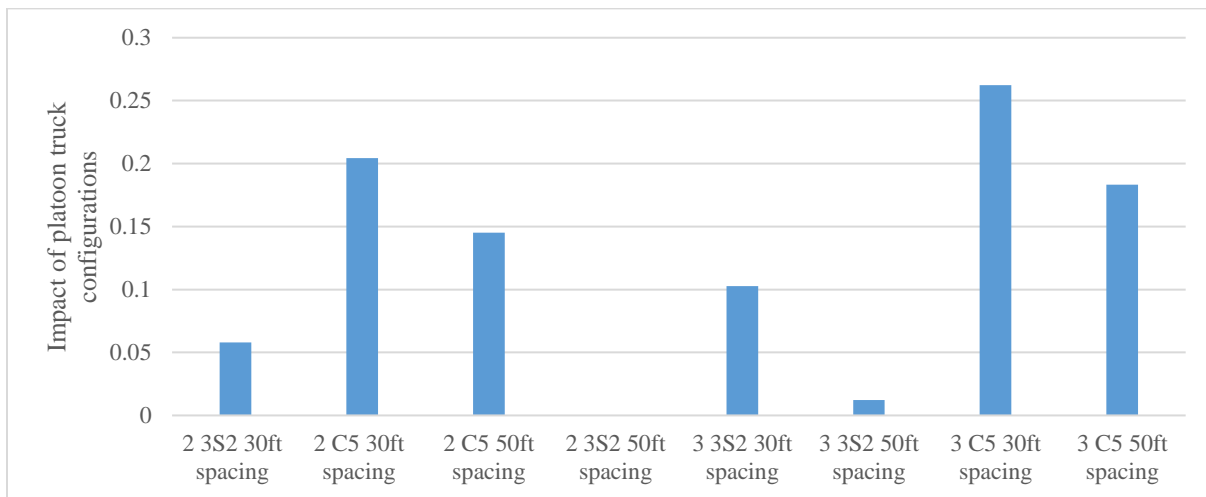
In considering the two 3S2 Truck platooning at 50-ft scenario as the base-case scenario, the transition matrix for each scenario was estimated using estimated values for the three performance indicators for each of the 20,331 bridges (see Table 8.5). Similarly, the transition matrix for temporal changes in the performance indicators could be collected, and a transition matrix for each bridge or pavement section could be constructed under a given scenario.

**Table 8.5. Transition Matrix under Different Platooning Scenarios.**

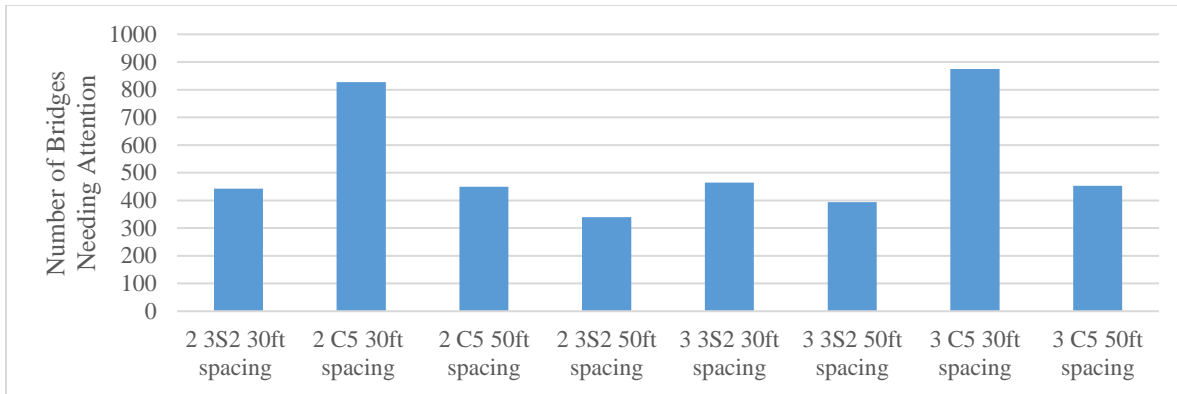
Comparison With	Markov Transition Matrix (original raw values)	Eigenvalues	Average Eigenvalue
2 3S2 30-ft spacing	[[ 0.907 -0.020 -0.015] [ 0.032 0.962 0.009] [ 0.010 0.009 0.956]]	[0.928 0.957 0.950]	0.94
2 C5 30-ft spacing	[[ 0.754 -0.023 -0.016] [0.030 0.811 -0.002] [0.018 0.014 0.822]]	[0.776 0.799 0.811]	0.79
2 C5 50-ft spacing	[[ 0.854 0.0001 0.001] [-0.010 0.844 -0.116] [0.011 0.008 0 0.865]]	[0.858 0.852 0.853]	0.85
3 3S2 30-ft spacing	[[0.880 -0.005 -0.003] [0.028 0.910 -0.002] [-0.016 -0.012 0.900]]	[0.910 0.887 0.894]	0.89
3 3S2 50-ft spacing	[[1.004 0.009 0.007] [-0.023 0.972 -0.008] [0.004 0.003 0.986]]	[0.994 0.985 0.983]	0.98
3 C5 30-ft spacing	[[0.710 -0.015 -0.012] [0.025 0.752 0.006] [0.009 0.008 0.750]]	[0.725 0.742 0.745]	0.74
3 C5 50-ft spacing	[[0.852 0.019 0.013] [-0.058 0.779 -0.016] [0.025 0.0195 0.819]]	[0.832 0.816 0.802]	0.82

The magnitude of an eigenvalue corresponding to certain performance indicators reflects the extent of the change of the network performance with respect to that performance indicator. Thus, a low eigenvalue corresponding to a certain performance indicator means a relatively

greater impact. The average value of all eigenvalues can be used to measure the overall impact of truck platooning on the performance of the whole network. This study used the difference between eigenvalues of 1 (indicating no change in performance) and the average of eigenvalues to quantify the overall impact caused by truck platooning. Overall impacts of truck platooning and automation on the bridges in the freight network under eight scenarios are presented in Figure 8.14. As can be seen, the network-wide impact of truck platooning is most significant when three C5 trucks are platooned. The same analysis was conducted using normalized values for the performance indicators, but no significant difference in the result was observed. The impact of platooning was assessed using two methods, one using the average eigenvalues of the transition matrix (Figure 8.14). It is worth noting that Figure 8.14 shows the impact under the two 3S2 trucks at the 50-ft spacing scenario is zero because, as mentioned earlier, the researchers assumed that this scenario (2 3S2 at 50 ft) is the base case, and each of the possible scenarios (including itself) is compared to this scenario. The other method used to estimate the impacts of truck platooning was the use of a performance indicator (called priority rating) for the bridges (Figure 8.15). The first method enables a more comprehensive evaluation of the impact of the truck platooning on the bridges in the freight network because it uses the performance indicators of the entire bridge population as model inputs.



**Figure 8.14. Overall Impact of Truck Platooning on Bridges (based on eigenvalues).**



**Figure 8.15. Number of Bridges Needing Attention after Full Truck Platoon (based on PR).**

In summary, the research team proposed a comprehensive PR index to quantify a bridge’s ability to support truck platoons. Second, a Microsoft Excel tool was developed for conveniently identifying bridges that need attention at different spatial scales. Finally, the impact of platooning was assessed using two different methods: (a) key performance indicators (PR) for the bridges; and (b) full Texas Freight Network–level analysis. The main findings of the bridge vulnerability study include:

- Truck gap spacing has a moderate impact on bridge vulnerability. For example, there is a 33 percent increase in the number of high-priority bridges when truck spacing is reduced from 40 to 30 ft.
- The number of trucks in a platoon has a minor impact.

Policy or investment implications of bridge vulnerability analysis include:

- Some truck platoon configurations (for example, three C5 trucks at 30-ft spacing) have a higher impact on bridges than others.
- Introducing guidelines for platoon truck weight distributions can be a way to reduce the impact.
- A network-level analysis tool can be used to assess future platooning configuration policies holistically.

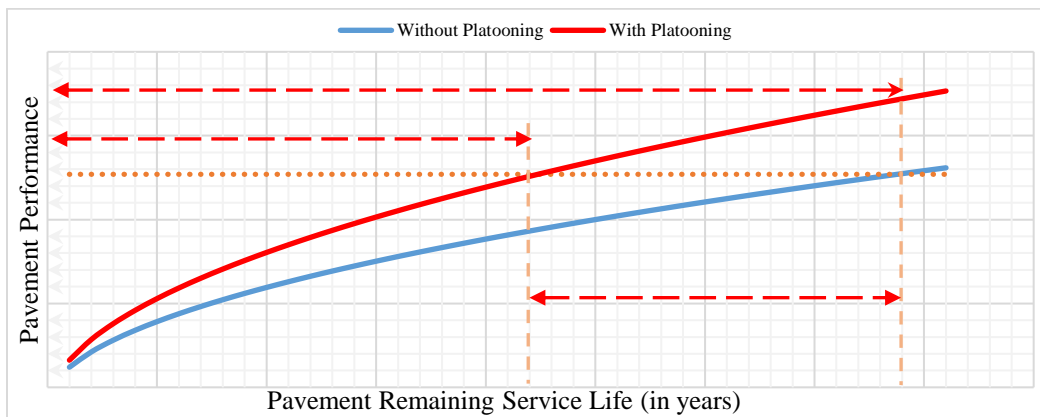
## **TEXAS FREIGHT NETWORK PAVEMENT CASE STUDY**

### **Analysis of LTPP Pavement Sections**

Under normal truck traffic (i.e., no automated trucks or platooning) scenarios, due to the drivers’ inability to steer perfectly straight and maintain a constant tire distance from the edge of the road and lane markings, pavements will be subject to relatively scattered loads. In comparison, automated and platoon truck control systems have the ability to control very precisely the distance of the truck from the edge of the pavement and from lane markings. The variability in the distance from the center of the wheel paths is termed *wheel wander* and is described by a

probability density function. In this case study, the researchers quantified the differences in rutting service life between a normal traffic scenario (i.e., full WW effects) and a full truck automation scenario without WW effects. In this analysis, there were 22 asphalt pavement sections with detailed historical performance records. The researchers used the FHWA LTPP flexible pavement sections in Texas for this study. For each pavement section, the rutting values under two scenarios (non-WW and WW) were obtained. In total, 174,601 hours of rutting were observed at 600-hour intervals (25 days). Every 25 days, one value was collected, and in total, there were 292 observations, which is equivalent to 19.93 years. Rutting values were recorded in inches. As illustrated in the rutting performance curves under the two scenarios (Figure 8.16), as the rutting threshold increases, the gap between the two curves tend to be wider, and the estimated RSL is greater. RSL is estimated using the equation below:

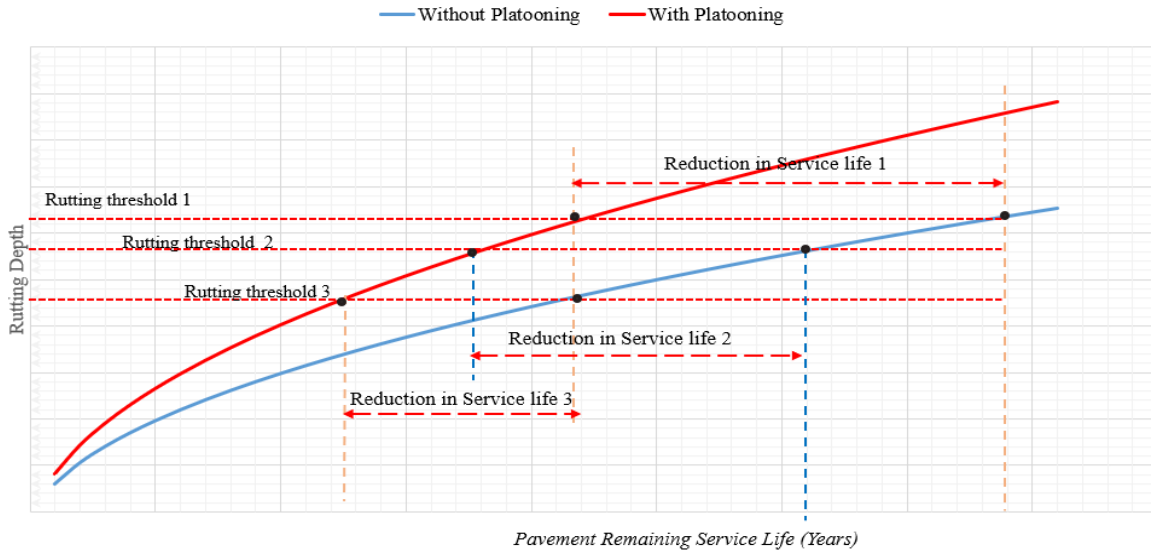
$$\text{RSL} = \text{Service life under no platooning} - \text{Service life under platooning}$$



**Figure 8.16. Pavement Remaining Service Life under Non-platoon and Platoon Scenarios.**

As Figure 8.17 shows, if the threshold was reached for both scenarios, RSL under three different rutting thresholds equaled  $RSL_1 > RSL_2 > RSL_3$ .





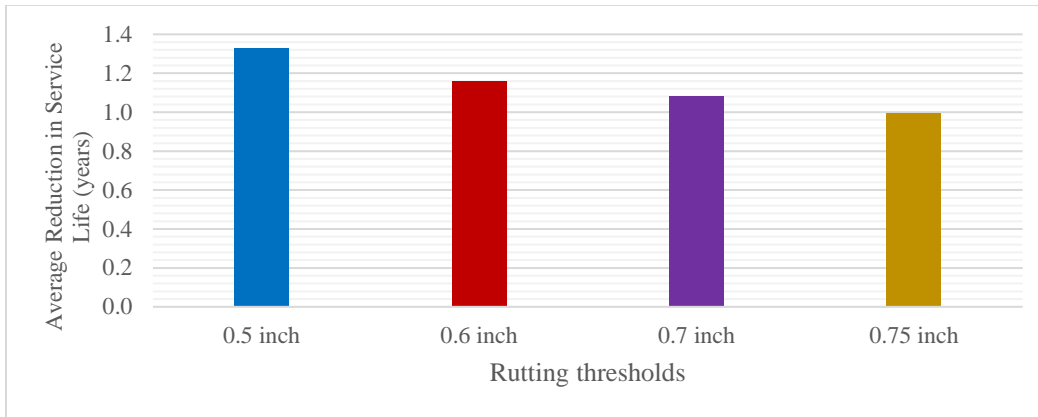
**Figure 8.17. RSL Estimation under Different Rutting Thresholds.**

For two common rutting thresholds, 0.5 inches and 0.75 inches, the RSL for each of the 22 flexible pavement sections was estimated (Table 8.6).

**Table 8.6. RSL under Different Rutting Thresholds.**

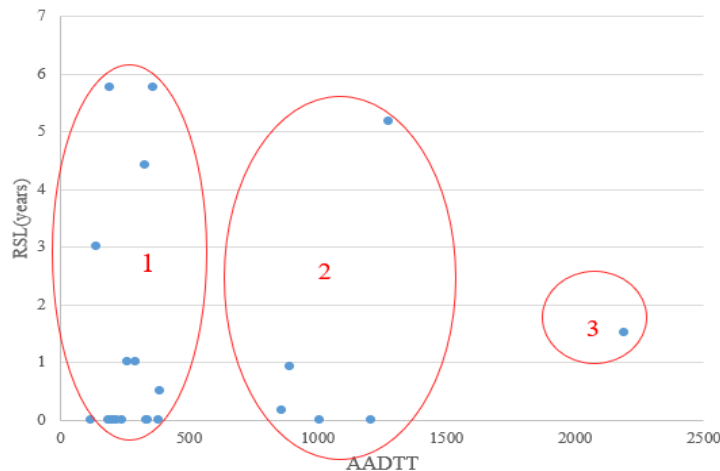
Pavement sections	AADTT	RSL (years)		
		0.5 inch threshold (TxDOT)	0.6 inch threshold	0.75 inch threshold (FDOT)
1039	1010	0.14	0.21	1.03
1048	121	13.42	0.00	0.00
1050	189	18.97	17.67	13.56
1056	195	16.78	17.88	15.14
1061	263	19.04	17.95	14.38
1076	295	7.12	16.64	16.16
1087	140	12.53	4.52	0.00
1111	365	0.96	1.92	3.97
1116	861	5.96	13.01	18.42
1119	339	14.52	16.44	12.26
1130	220	17.47	15.34	7.53
1174	244	2.81	5.07	13.08
1178	337	15.14	9.52	0.00
1183	385	2.81	4.73	11.99
3689	210	2.95	5.89	16.03
3729	1280	0.07	0.14	0.96
3749	200	4.32	11.23	18.42
3875	1210	3.84	7.88	18.42
6079	2190	1.92	3.97	10.21
6086	895	0.89	1.03	2.19
6160	331	2.88	5.68	14.04
6179	390	2.67	5.89	15.21

Based on the simulation results of rutting for the 22 flexible pavement sections, the average RSL under the two different rehabilitation thresholds for rutting was obtained. At a 0.5-inch rutting threshold, which TxDOT uses, the average RSL due to the introduction of platooning is about 1.3 years. In contrast, at a 0.75-inch rutting threshold, which, for example, FDOT adopts, the average RSL for the pavements is about 1 year. This element not only shows that the estimation of the RSL is sensitive to the threshold value chosen but also implies the importance of selecting an appropriate threshold value for maintenance and rehabilitation purposes. In addition, the researchers observed a negative correlation between the RSL and the AADTT, as expected. It was observed that at a 0.5-inch rutting threshold, a significant negative correlation between AADTT and RSL exists. Further analysis of the relationship between average RSL and rutting threshold is presented in Figure 8.18.



**Figure 8.18. Average RSL under Different Rutting Thresholds.**

In Figure 8.19, the relationship between simulation results of rutting for the 22 LTPP flexible pavement sections and corresponding AADTT data (for 2016) is presented. As can be observed, comparatively, a higher variance occurs in the RSL when the AADTT values are lower, which is not surprising since the pavements designed for more moderate truck traffic also tend to have lower design reliability. Three clusters are observed from the scatter plot, and the average values of the RSLs in each of the clusters were used to estimate the RSL in the flexible pavements of the entire Texas Freight Network. The relationship between RSL and AADTT values is presented in Table 8.7.



**Figure 8.19. RSL Estimation Based on Rutting and AADTT.**

**Table 8.7. Relationship between AADTT and RSL for Flexible Pavements.**

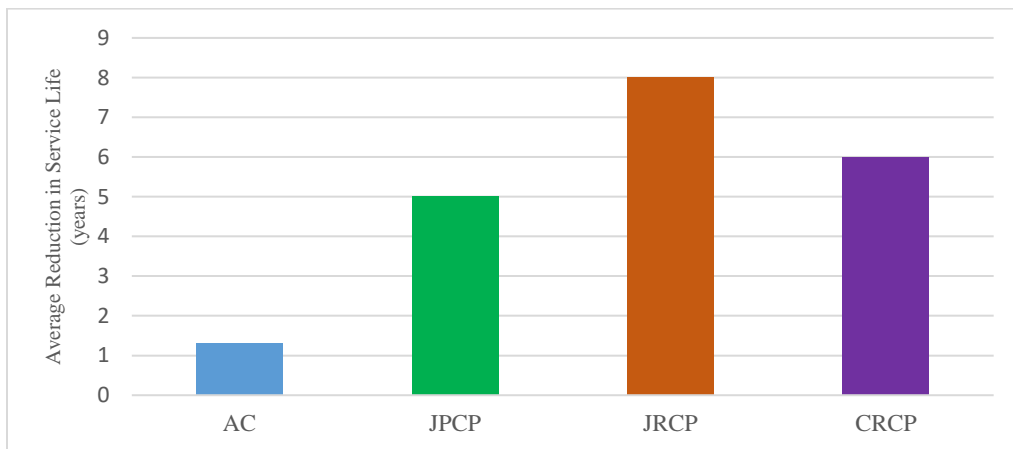
Cluster	Number of pavement sections	AADTT range	Average RSL based on rutting (years)	Average RSL based on BUC (years)	Average RSL based on TDC (years)
1	16	Between 0 and 500	1.3	2.9	2.7
2	5	Between 500 and 1200	3.1	3.8	3.1
3	1	Above 1200	0.7	2.8	0.6

For rigid (concrete) pavements, the researchers analyzed 11 pavement sections (Table 8.8) consisting of three types of common concrete pavements. These three main concrete pavement categories are continuously reinforced concrete pavements (CRCP), JRCP, and jointed plain concrete pavement (JPCP). Similar to the approach used to estimate the RSL of flexible pavements, corresponding performance indicators, faulting (with a 0.12-inch threshold) and fatigue cracking (with a 15 percent threshold), were used for JPCP. Faulting (with a 0.12-inch threshold) was used for JRCP, and the punchout number (with a 15 punchouts/mile threshold) was used for CRCP pavement. The number of pavement sections in each pavement category is presented in Table 8.8, as are the performance indicators used to evaluate the service life of the corresponding pavement sections.

**Table 8.8. Pavement Types, Number, and Performance Indicator.**

Pavement Type		Number of Pavement Sections Studied	Performance Indicators Used
Flexible Pavements	Asphalt concrete (AC)	22	Rutting, BUC, TDC
Rigid Pavements	Jointed plain concrete pavement (JPCP)	3	Faulting and fatigue cracking
	Jointed reinforced concrete pavement (JRCP)	6	Faulting
	Continuously reinforced concrete pavements (CRCP)	2	Punchout Number

The average RSL for each type of pavement, based on the pavement sections and threshold values used, are presented in Figure 8.20.

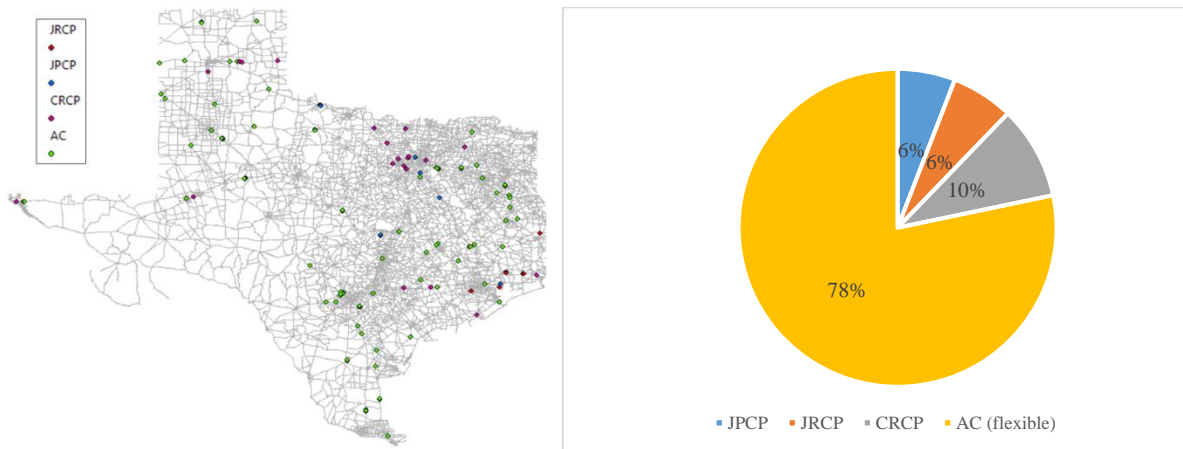


**Figure 8.20. Average RSL for Different Pavement Types.**

Due to the very large scope of analyzing the Texas Highway Freight Network at the detailed pavement section level, this study performed a detailed analysis of existing FHWA LTPP pavement sections in Texas and used the results to extrapolate onto the remaining Texas Highway Freight Network. In order to extrapolate the results and findings from the limited

number of LTPP sections (Figure 8.21) into the entire Texas Freight Network, several assumptions regarding the ratio of the pavement types on the Texas Freight Network and the relationships between roadway type and average AADTT values were made. More specifically, the main assumptions were:

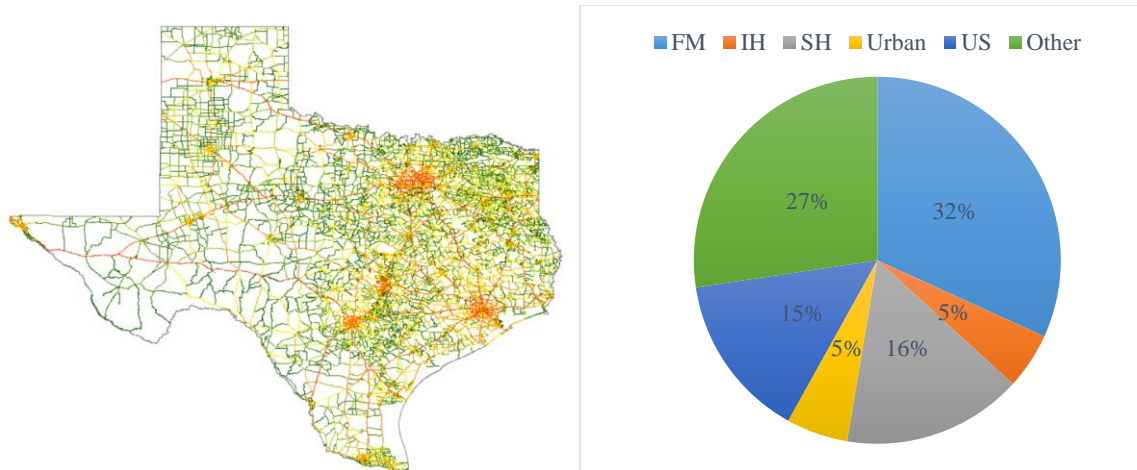
- Each polyline in the TxDOT freight network shapefile represent a pavement section in the freight network.
- The fraction of the pavement types in the LTPP pavement sections for Texas (AC-78%, CRCP-10%, JPCP-6%, and JRCP-6%) is the same as the fraction of pavement types in the entire Texas Freight Network.
- Pavements with the highest AADTT values (i.e., ones on IH or US highways) are rigid pavements in the Texas Highway Freight Network.
- Pavements with medium to lower AADTT values (other road types, FM, urban, SH) are flexible pavements.



**Figure 8.21. LTPP Pavement Sections for Texas and Their Classification (source: FHWA).**

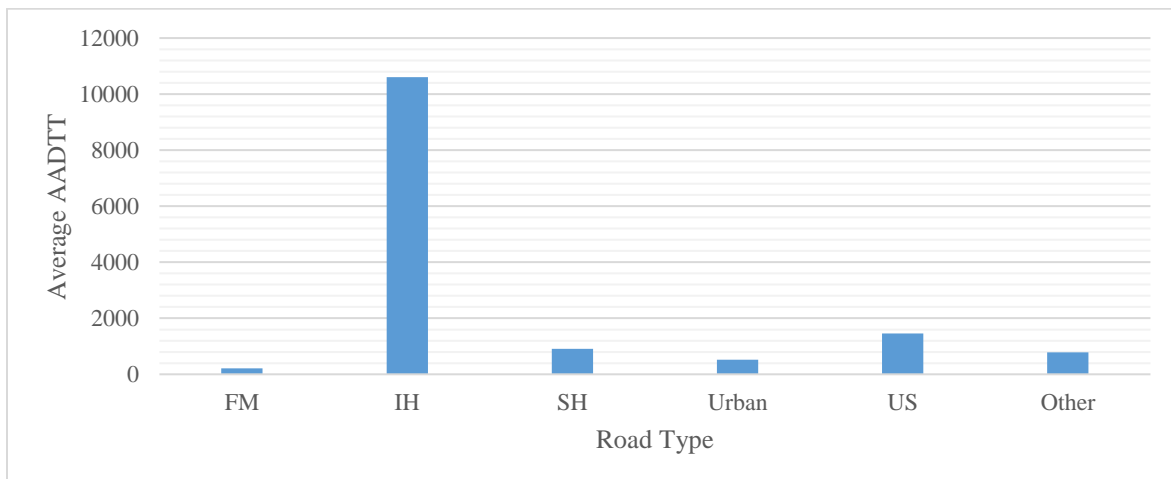
### Texas Freight Network Pavements

In the Texas Highway Freight Network, there are 64,816 pavement sections. Based on the 2016 AADTT distribution in Figure 8.22, orange-colored pavements mean very high AADTT values, while light green pavements denote very low AADTT. The percentage of pavement sections on IH and US highway systems is 5 percent and 15 percent, respectively.



**Figure 8.22. AADTT in Road Classification Texas Freight Network (the year 2016).**

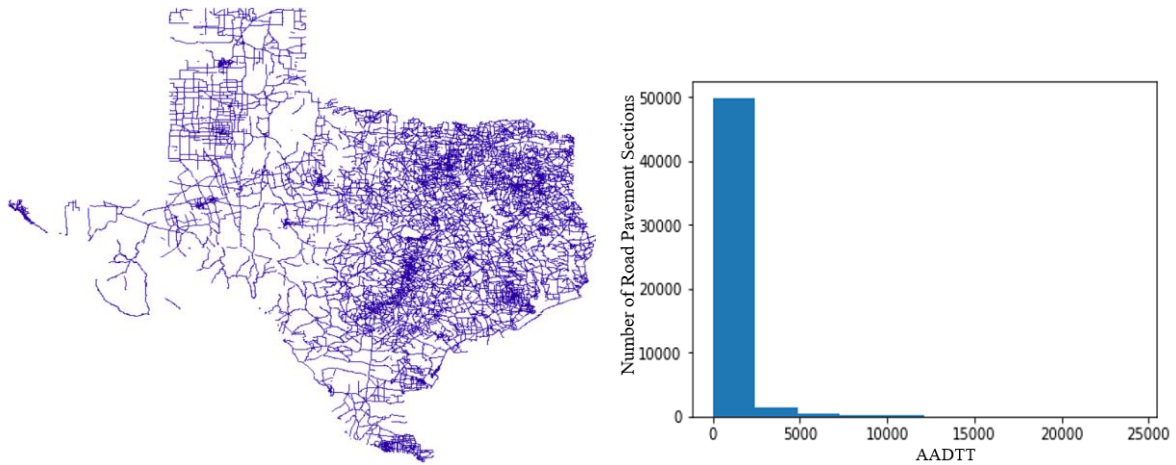
Average AADTT values for each type of road in the network are presented in a histogram in Figure 8.23. The IH have the highest concentration of freight traffic, while the US highway system is second.



**Figure 8.23. Average AADTT by Road Type in Texas Freight Network.**

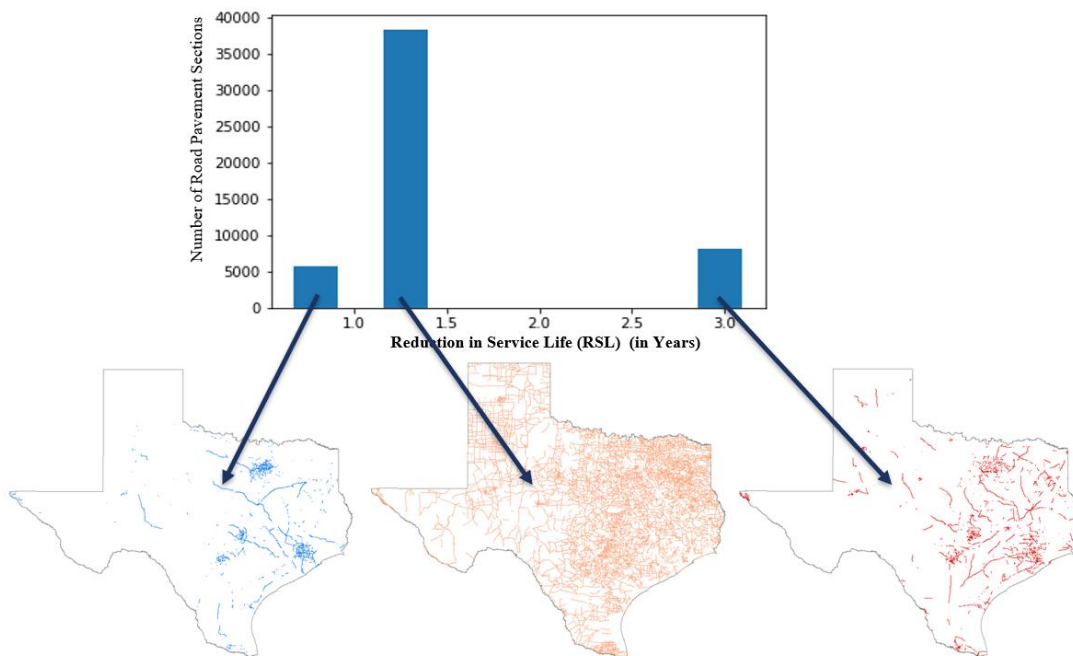
### *Analysis of Flexible Pavements*

Based on the simplifying assumptions made in the earlier sections of the report, the resulting graph-based model of the Texas Highway Freight Network ultimately consisted of about 50,500 flexible pavements sections, and the majority of the pavement sections had relatively low AADTT values (see Figure 8.24).



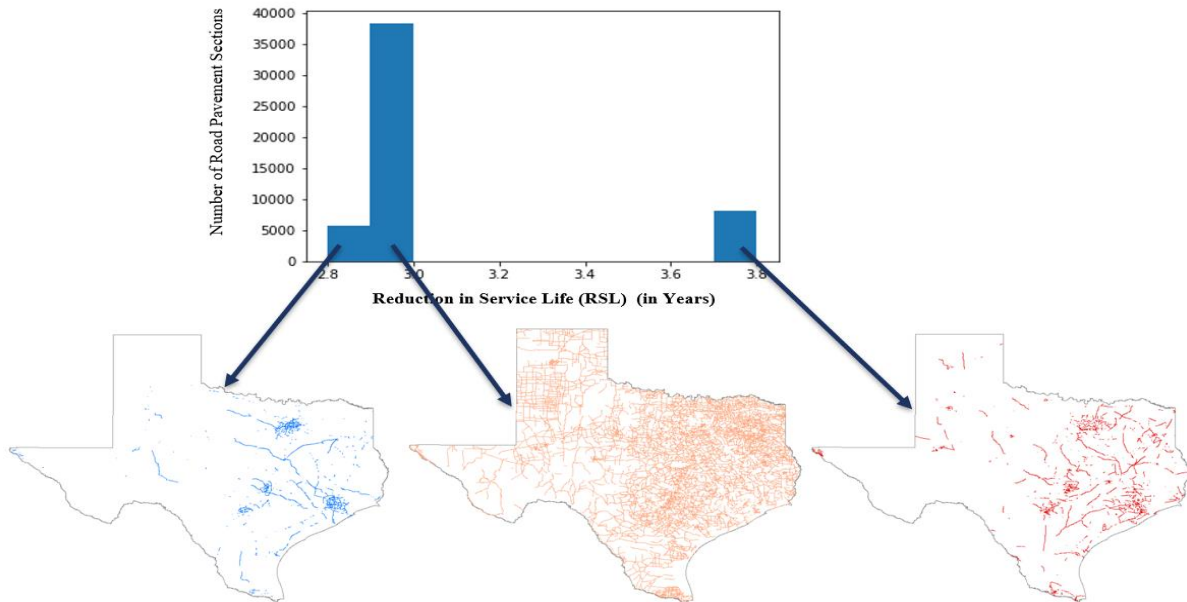
**Figure 8.24. Flexible Pavement Sections and AADTT Histogram in Texas Freight Network.**

The RSL estimation based on rutting is presented in Figure 8.25 for the flexible pavement sections in the Texas Highway Freight Network.



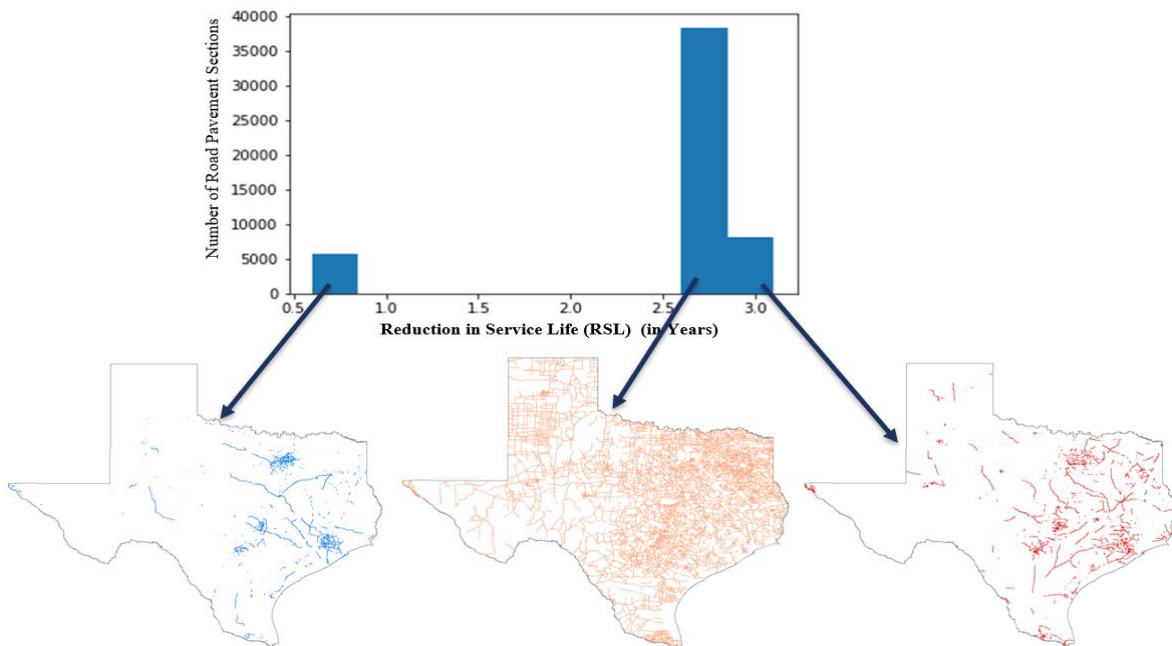
**Figure 8.25. RSL Estimation Based on Rutting for Flexible Pavements in the Texas Highway Freight Network.**

The RSL estimation based on BUC is presented in Figure 8.26 for the flexible pavement sections in the Texas Highway Freight Network.



**Figure 8.26. RSL Estimation Based on BUC for Flexible Pavements in the Texas Highway Freight Network.**

The RSL estimation based on TDC is presented in Figure 8.27 for the flexible pavement sections in the Texas Highway Freight Network.

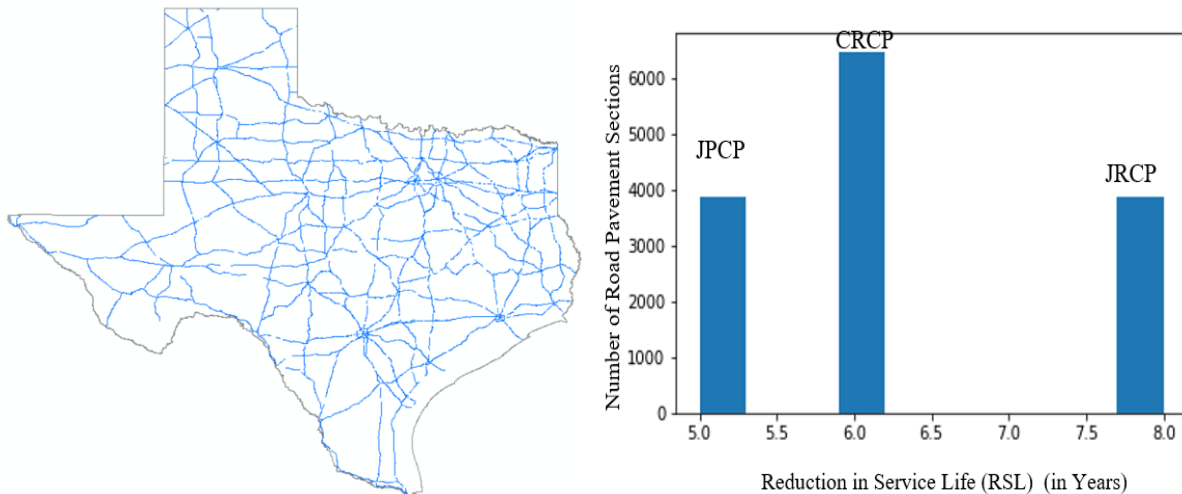


**Figure 8.27. RSL Estimation Based on TDC for Flexible Pavements in the Texas Highway Freight Network.**



## Analysis of Rigid Pavements

The performance of three types of rigid pavements under platooning and non-platooning scenarios was studied using a similar approach, and corresponding RSL values were estimated. The histogram of the RSL is shown in Figure 8.28 for the rigid pavement sections based on the RSL results estimated for the LTPP pavement sections. Because of the limited number of pavement sections in each category, both RSL and its variance are significantly greater for rigid pavements, with JRCP pavement showing the greatest RSL.

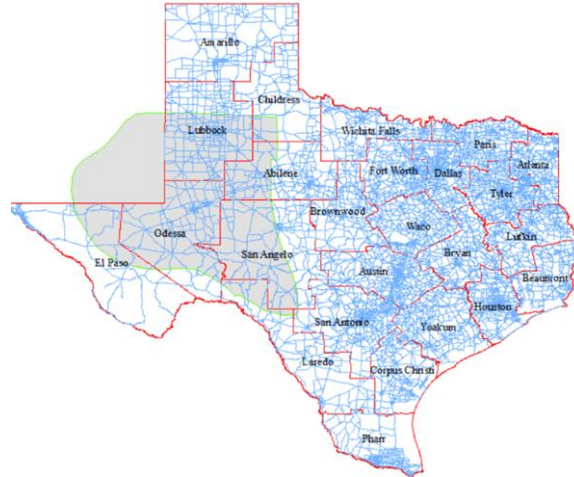


**Figure 8.28. RSL Estimation for Rigid Pavements in Texas Highway Freight Network.**

In order to demonstrate the efficiency of the proposed methodology, a similar analysis was also conducted for the pavement sections (both flexible and rigid) for the Permian Basin Highway Freight Network and Odessa District Highway Freight Network (shown in Figure 8.29).

Policy, planning, and investment implications of findings from the pavement study include:

- Under truck platooning, all key flexible pavement failure types are accelerated. Therefore, identifying dedicated hardening truck routes is an option.
- Introducing dedicated truck lanes is also an option.
- The impact from the introduction of automated and platoon truck traffic was most significant for TDC in flexible pavements. Specific hardening actions that improve the cracking life of flexible pavements on key truck routes can improve the service life of pavements.
- For concrete pavements, the RSL for the JRCP was the greatest. Thus, stopping or downscaling the construction of JRCP pavements on highway lanes used by autonomous/platoon trucks is an option.
- Results show that all modes of failure are diminished by the introduction of HPMA. Therefore, introducing dedicated truck lanes on key routes using PMA concrete is a viable option.



**Figure 8.29. Texas Odessa District Highway Freight Network.**

## RESULTS AND CONCLUSIONS

The results from the analysis of the bridge and pavements were presented separately. On the bridge side, based on the estimated impacts of truck platooning and truck automation on individual bridges obtained previously in Task 4, the researchers identified bridges that may benefit from hardening or rehabilitation and assessed the impacts of rehabilitation options on the overall connectivity of the highway freight network. A comprehensive PR measure for the overall condition of the bridges was used for this analysis. It was found that raising the PR threshold from 0.5 to 0.7 may identify the bridges that can most benefit from rehabilitation. Interestingly, the study found that many of these bridges were on main freight corridors like I-10 and I-20. Furthermore, the impacts of different platooning scenarios (i.e., different truck types, number, and spacing) were quantified using two independent methodologies. It was found that a truck platoon that uses a C5 truck type at 30-ft spacing (whether the number of trucks is two or three) has the greatest impact on the bridges in the Texas Highway Freight Network.

On the pavement side, similarly, based on the performance estimation results from Task 4 for different types of pavement sections, the overall impacts of truck platooning on the Texas Highway Freight Network were quantified using the RSL for all pavement sections in the highway freight network. Pavement data (AADTT, road type, and pavement type) from the LTPP database were used to extrapolate the results from the studied pavement section onto the entire Texas Highway Freight Network. It was found that (a) RSL is relatively more severe in rigid pavements than flexible pavements; (b) there is a higher variability for the RSL in flexible pavement sections that have lower freight traffic; (c) using PMA can improve the service life of the flexible pavement sections under the truck platooning scenario, and the greater the level of modification the greater the improvement; and (d) both types of cracking (both top-down and bottom-up) are primary concerns once full truck automation and platooning is introduced onto the highway freight network. All three types of pavement degradation (rutting, BUC, and TDC) are reduced when polymer-modified asphalts are introduced.

# CHAPTER 9. ANALYSIS OF OVERALL ECONOMIC IMPACT OF PLATOONING AND TRUCK AUTOMATION ON TEXAS HIGHWAYS

## OBJECTIVE AND ECONOMIC EVALUATION FRAMEWORK

The objective of Task 6 was to identify the potential benefits and costs that platooning and truck automation may have on the overall economy of Texas. This objective was accomplished through the development of scenarios that considered advancements in truck automation over the study period of 30 years. Table 9.1 provides the years associated with the short-term, midterm, and long-term analysis periods.

**Table 9.1. Time Periods Used for Scenario Analysis.**

Short Term		Midterm		Long Term	
Year #	Year	Year #	Year	Year #	Year
1	2021	6	2026	16	2036
2	2022	7	2027	17	2037
3	2023	8	2028	18	2038
4	2024	9	2029	19	2039
5	2025	10	2030	20	2040
		11	2031	21	2041
		12	2032	22	2042
		13	2033	23	2043
		14	2034	24	2044
		15	2035	25	2045
				26	2046
				27	2047
				28	2048
				29	2049
				30	2050

This chapter describes the components of the base case and the platooning and automation aspects associated with the scenarios. Next, the chapter discusses the selection of the case study corridor, the cost components incorporated into the economic evaluations, the benefit-cost analysis, and the economic impact analysis.

## SCENARIO DEVELOPMENT

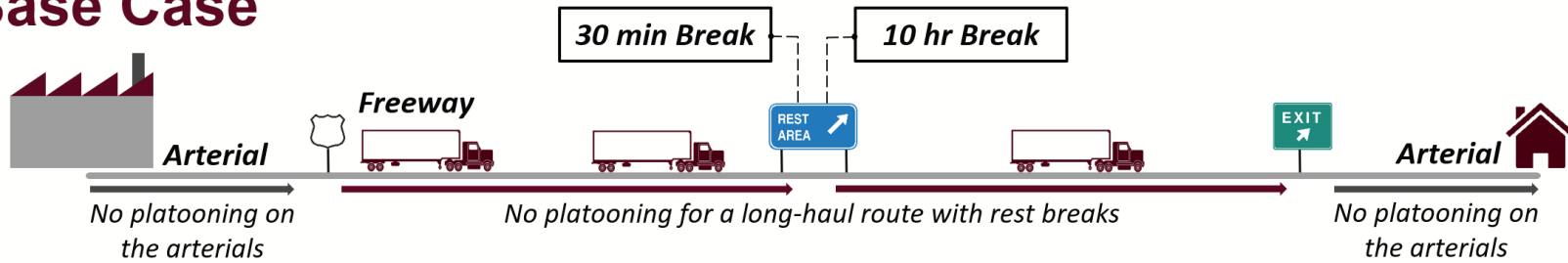
The scenario development process included identifying aspects of a long-haul truck trip between an origin and destination, with the initial and final segments of the trips occurring along arterial roadways and the main middle segment traversing IH. Figure 9.1 shows the base case, in which two separate trucks transporting goods travel independently over the entire corridor. The trip length was designed to encompass HOS-required 30-minute breaks and 10-hour rest periods.

The economic analysis compares the base case against scenarios that are comprised of three time periods, defined above. The near-term time period is also depicted in Figure 9.1. During the near-term period, the two trucks operate independently over the arterial roadways but connect to operate as a two-truck platoon over the interstate. Both trucks maintain a driver who requires the HOS breaks. Operating in platoon produces fuel savings compared to the base case.

Figure 9.2 depicts the midterm and long-term periods, in which truck automation is incorporated. For the midterm period, the shipments travel independently by two trucks with drivers to a transfer port. At the transfer port, the shipments transfer to a lead truck driven by a driver followed in platoon by an autonomous truck. The analysis has the transfer ports operated by the private sector, with a user fee associated with the use of the facility. Other options can include the transfer occurring at a public-owned facility at no charge (such as at designated truck parking spots within a rest area) or through the use of a combination of public and private transfer ports. Because a driver remains in the lead truck, HOS-required breaks are still in effect.

Long-term projections have both trucks traveling the entire trip autonomously, with platooning occurring on the interstate, which eliminates the need for drivers and the requirement for HOS breaks.

# Base Case



Base Case	2 / 2	No	No	Yes (labor/time)
<b>Scenario</b>	<b>Number of Drivers (arterials / freeway)</b>	<b>Freeway Platooning</b>	<b>Fuel Savings</b>	<b>HOS Regulation</b>
Near-Term	2 / 2	Yes	Yes	Yes (labor/time)

163

# Near-Term

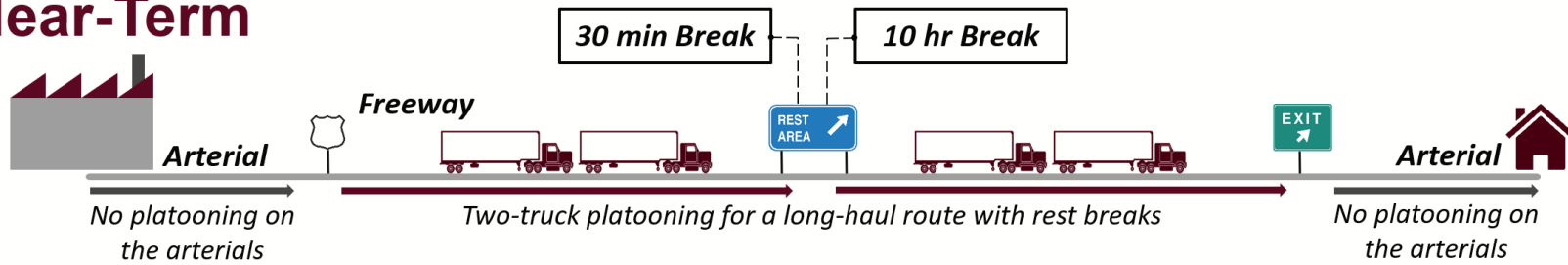
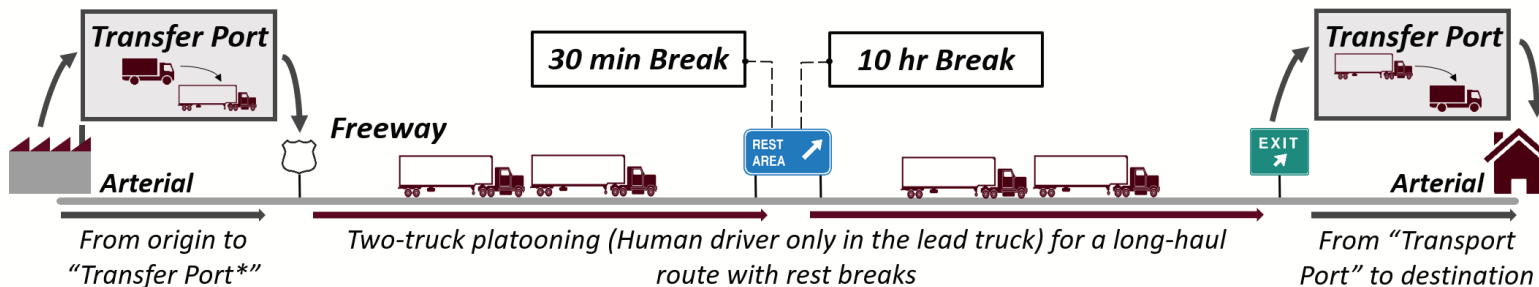


Figure 9.1. Scenario Development Base Case and Near-Term Period.

## Mid-Term



Mid-Term	2 / 1	Yes	Yes	Yes (labor/time)
Scenario	Number of Drivers (arterials / freeway)	Freeway Platooning	Fuel Savings	HOS Regulation
Long-Term	0	Yes	Yes	No

164

## Long-Term

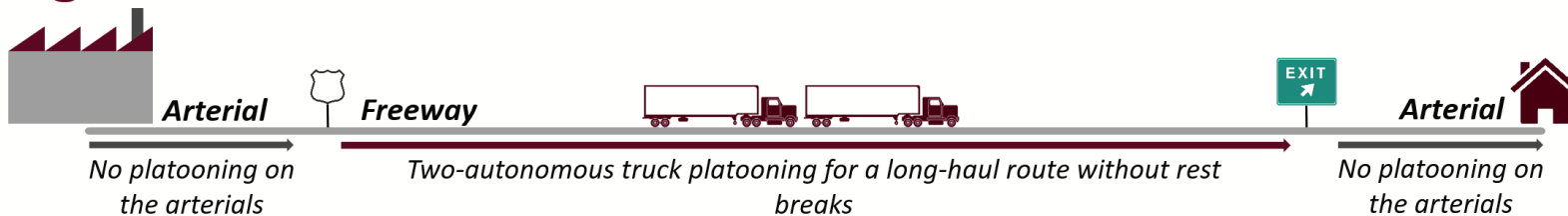


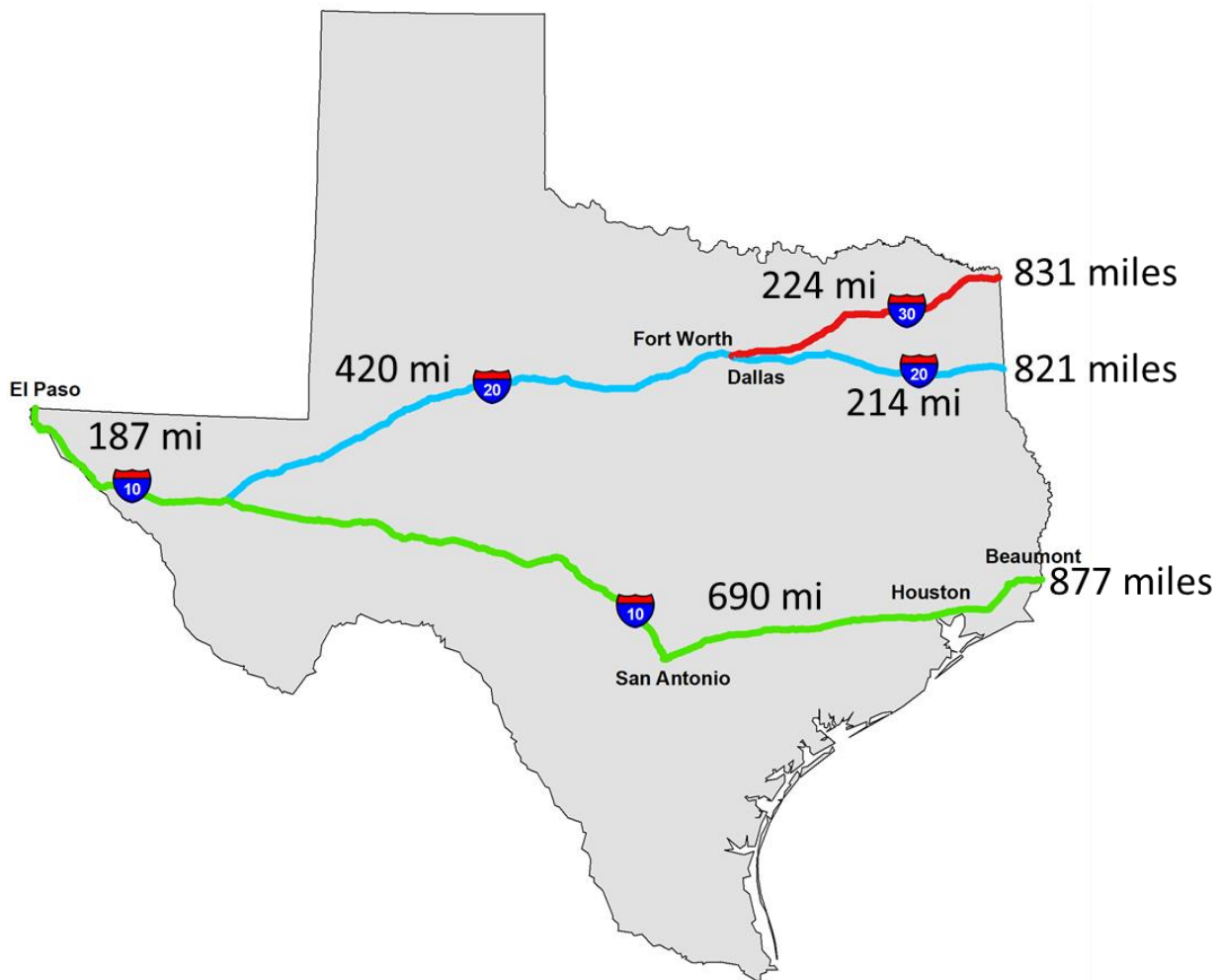
Figure 9.2. Scenario Development Midterm and Long-Term Periods.

## CASE STUDY CORRIDOR

A case study corridor in the state was desired to capture actual values for the economic evaluations, where available. The project team investigated three corridors that are long enough to require HOS breaks and also meet several other criteria, including:

- High truck traffic volumes.
- Variety of pavement types and conditions.
- Population of bridges of concern, as identified within Task 5.

Figure 9.3 depicts the three corridors examined for the case study and provides the segment and overall length of all three corridors. The longest corridor is the El Paso to Orange corridor (at 877 mi), followed by the El Paso to Texarkana corridor (831 mi), and El Paso to the Texas/Louisiana border along I-20 (821 mi).



**Figure 9.3. Candidate Case Study Corridors.**

The project team chose the corridor between El Paso and Texarkana, which includes segments on I-10, I-20, and I-30, as the case study corridor. It provides the necessary length for the analysis, large numbers of bridges, and a good breakdown of pavement types and acts as a major trade corridor through the state. Moreover, this corridor also passes through the Permian Basin energy area, where several of the bridges of concern identified in Task 5 were located.

### Case Study Corridor Characteristics for Scenario Planning

This section identifies the characteristics of the study corridor required for the economic evaluation. In addition to the corridor length, these characteristics include trip times, truck volumes, number of platoons, and truck traffic growth rate.

As shown in the previous section, the scenario corridor segments include traversing arterial roadways for the beginning and end of the trip, while the middle uses the interstate. Table 9.2 contains the attributes of each segment and trip component in order to calculate the trip time for the entire trip, which is shown in Table 9.3. Table 9.2 shows the assumed speeds associated with the trip element, including 40 mph for all non-highway trip segments and 65 mph for the interstate long-haul portion of the trip. For distances, the interstate portion reflects the chosen El Paso to Texarkana study corridor distance of 831 mi. It was assumed the origins and destinations were close to the interstate and that it would take a 20-mi trip to get to the transfer port utilized during the midterm period. Break distances include the distance to the location of the HOS break locations. It was assumed that extra time would be needed for things like eating or exercising, along with the 10.5 hours of HOS time; therefore, the combined HOS time totaled 13.0 hours.

Table 9.3 tabulates the overall trip time for the base case and the three time periods. Travel time plus HOS breaks total 26.2 hours for the base case and near-term period. The midterm period adds an hour for the transfer port and totals 27.2 hours. The long-term period, reflecting full automation, reduces the overall trip time to 13.0 hours.

**Table 9.2. Study Corridor Travel Time Components.**

Segment	Speed	Distance	Travel Time (hr)	HOS (hr)
Arterial	40	5	0.1 x 2	—
Interstate	65	831	12.8 x 1	—
Transfer Port	40	20	0.5 x 2	—
Breaks	40	2.5	0.1 x 2	13.0

**Table 9.3. Study Corridor Trip Time.**

Period	Travel Time (hr)	HOS (hr)	Total Trip Time
Base case	13.2	13.0	26.2
Near term	13.2	13.0	26.2
Midterm	14.2	13.0	27.2
Long term	13.0	—	13.0



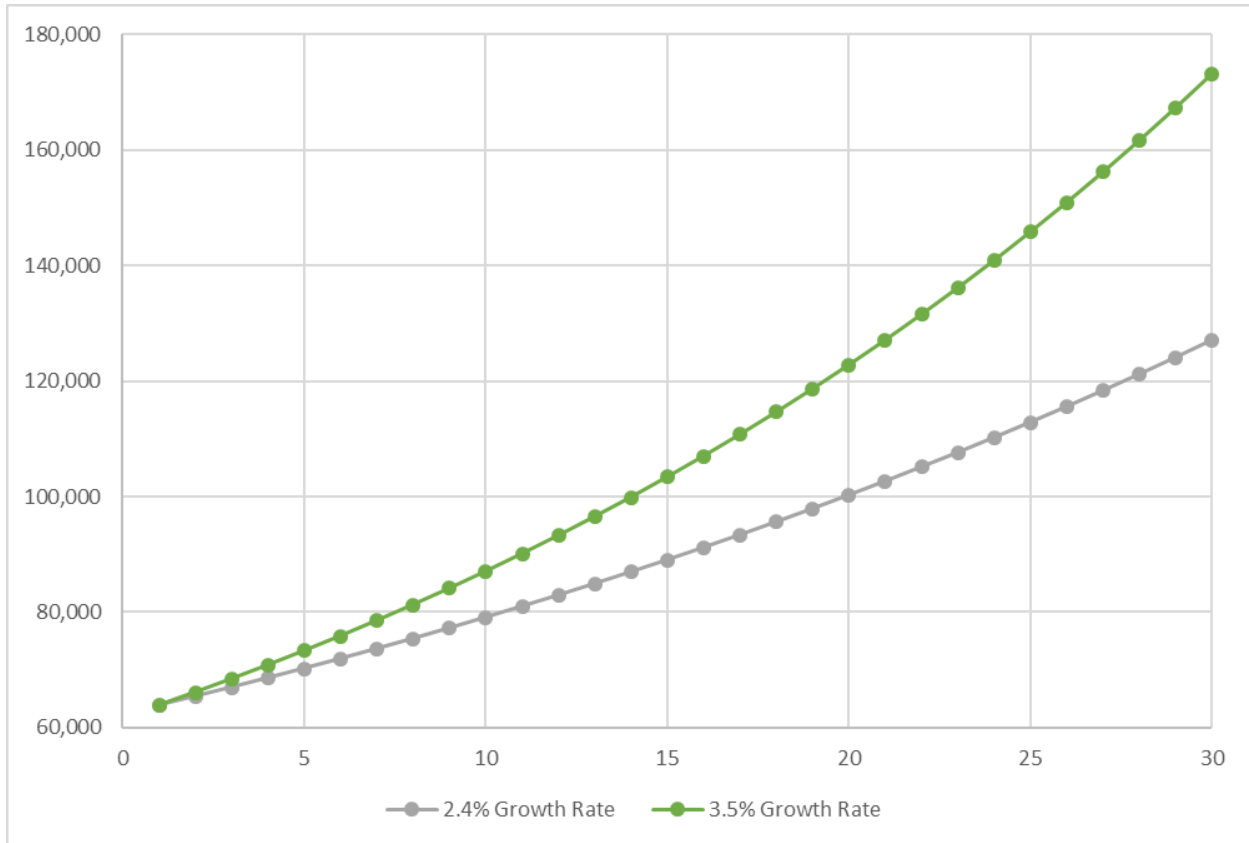
The goal for estimating the number of trucks to include in the economic analysis was to identify the number of trucks traversing the entire corridor and the number of truck platoons. The project team utilized the TFMP estimates (Table 9.4) of freight patterns in the state to determine the through trucks on the study corridor. The TFMP estimates that 9.4 percent of freight moves through Texas. These movements are expected to expand from 210 million tons in 2016 to 416 million tons in 2045, reflecting an annual growth rate of 2.4 percent. The project team utilized this growth rate for one of the scenarios. The other scenario considers a higher growth rate of 3.5 percent.

**Table 9.4. TFMP Texas Freight Flow Patterns.**

Freight Flows	2016		2045	
	Million Tons	Percentage	Million Tons	Percentage
Into Texas	569	25%	801	20%
Out of Texas	453	20%	887	22%
Within Texas	1,001	45%	1,936	48%
<b>Through Texas</b>	<b>210</b>	<b>9.4%</b>	<b>416</b>	<b>10.3%</b>
Total	2,233	100%	4,040	100%

Source: *Texas Freight Mobility Plan (108)*.

Truck volumes along the corridor were collected from a GIS file provided by the TFMP contractor. Using the 9.4 percent value for through trucks, it was estimated that 312 trucks utilized the study corridor to traverse the entire state in 2016. After expanding that to the analysis period start year of 2021 using the 2.4 percent growth rate, the number of daily trucks is 350 trucks per day. It was assumed during the analysis that all through trucks would pair into a platoon, which would total almost 64,000 truck platoons per year in 2021. The annual platoons over the 30-year period for both growth scenarios are shown in Figure 9.4.



**Figure 9.4. Annual Platoons over 30-Year Study Period.**

### CASE COST ELEMENT

The economic evaluation considers a number of cost elements. These elements were grouped into four broad categories: vehicle configuration, vehicle operational environment, safety and labor, and infrastructure. The included cost elements under each category include:

- Vehicle Configuration.
  - Fuel Savings.
  - Fuel Cost.
  - Environmental Costs.
  - Truck Technology Costs.
- Vehicle Operational Environment.
  - HOS Break Costs.
  - Transfer Port Cost.
  - Commodity Profile.
- Safety and Labor.
  - Driver Wages.
  - Insurance Costs.
  - Accidents.

- Infrastructure.
  - Bridge Costs.
  - Pavement Costs.

Most cost elements were captured from literature or shaped according to sources and are described later. The following section includes discussion of those cost elements requiring more explanation or discussion of cost elements developed through a significant process, such as for pavement and bridge costs. All costs have been inflated to 2020 dollars using the US GDP implicit price deflator.

## Cost Element Discussions

### *Vehicle Configuration*

Automation and platooning are assumed to positively impact the fuel efficiency of trucks, resulting in fuel cost savings as well as reductions in environmental costs. Based on several research projects, it is assumed that fuel efficiency will increase by 7 percent from a base of 6.4 miles per gallon. This increase efficiency results in a corresponding reduction in emissions, generating an environmental cost savings. Further, the automation equipment itself has an associated cost included in the analysis. The environmental assumptions used are shown below in Table 9.5.

**Table 9.5. Environmental Assumptions.**

<b>Emission Type</b>	<b>Base Emission Rate (Tons per VMT)</b>	<b>Emission cost per Ton</b>
Volatile Organic Compound (VOC)	0.0000004387	\$2,159
Nitrogen Oxide (NOx)	0.0000039099	\$8,840
Sulfur Oxide (SOx)	0.0000000107	\$51,497
Particulate Matter (PAM)	0.0000002712	\$398,098

### *Vehicle Operational Environment*

In the near- and midterm scenarios, truck drivers are assumed to use private truck stop facilities for a mandatory 10-hour HOS break to use a variety of amenities, such as fuel, restaurant, truck service, and shower. TravelCenters of America (TA), Petro, and TA Express stopping centers provide a truck parking reservation system through a smartphone application, which is called Reserve-It. An online pricing investigation revealed the cost of using the service ranged between \$15 per day and \$20 per day. The research team selected \$20 per day per truck for the analysis.

In the midterm scenario, the research team suggests using a transfer port concept by which local delivery is switched over to the platooning-enabled trucks for long-haul transport or vice versa. The research team assumed the cost of using a transfer port is similar to that of using private truck parking facilities; however, an extra \$5 is added to compensate additional costs, including initial construction cost, shipment handling fees, and other service costs that might be added in the future.

In the long-term scenario, break times are eliminated due to full automation, which creates benefits to customers shipping freight because they receive their goods sooner. That result creates benefits by reducing spoilage and allows customers to sell their goods sooner. The benefit changes based on the type of commodity. This analysis uses data from FHWA's Freight Analysis Framework to create a commodity profile for Texas.

#### *Safety and Labor: Driver Wages*

Driver wages were obtained from ATRI and the Bureau of Labor Statistics. Driver wages heavily impact the analysis because in the midterm one half of drivers are eliminated, and all drivers are eliminated in the long term. A large portion of the total benefits are attributable to the reduction in driver wages resulting from fewer drivers.

#### *Safety and Labor: Accidents*

With the implementation of advanced autonomous vehicle technologies, crashes and casualties that are associated with driver-related contributing factors are expected to decrease. Bracy et al. (109) suggested four significant contribution factors by running chi-square automatic interaction detection decision trees on Missouri large truck crash data:

- Too fast for conditions.
- Overcorrecting.
- Distracted/inattentive driving.
- Alcohol use.

The project team identified driver-related factors from Texas' large truck crash data from 2016 to 2018 that incorporated the number of crashes, fatalities, injuries, and non-injuries. Four driver-related factors consistent with the study performed by Bracy et al. were identified as being eliminated in the future by the adoption of autonomous truck technology.

The four driver-related factors used in this study are as follows:

- Speeding of any kind.
- Distraction, inattention, and cell phone use.
- Faulty evasive action.
- Impairment, including fatigue, alcohol, drugs, illness, etc.

Table 9.6 displays the calculation of the estimated reduction in crashes as a result of adoption of autonomous trucking technologies and Table 9.7 shows the accident cost per type of accident. The adoption would reduce the total number of crashes by 40 percent, fatalities by 51 percent, injuries by 51 percent, and non-injury crashes by 38 percent. Table 9.8 shows the cost elements that were captured from literature or shaped according to sources.

**Table 9.6. Estimated Reduction in Annual Crashes with Adoption of Autonomous Trucking.**

<b>Driver-Related Factors</b>	<b>Total Crashes</b>	<b>Fatalities</b>	<b>Injuries</b>	<b>Non-injury Crashes</b>
Speeding of any kind	4,728	68	2,577	8,989
Distraction/inattention/Cell phone use	3,125	34	1,129	5,785
Faulty evasive action	942	18	422	1,358
Impairment (fatigue, alcohol, drugs, illness, etc.)	513	29	314	457
<b><i>Reduced Truck Crashes with AV Adoption per Year</i></b>	<b><i>9,307</i></b>	<b><i>150</i></b>	<b><i>4,442</i></b>	<b><i>16,589</i></b>
<b><i>Total Annual Texas Crashes</i></b>	<b><i>23,470</i></b>	<b><i>294</i></b>	<b><i>8,695</i></b>	<b><i>43,699</i></b>
<b><i>Percent Crashes Reduced with AV Adoption per Year</i></b>	<b><i>40%</i></b>	<b><i>51%</i></b>	<b><i>51%</i></b>	<b><i>38%</i></b>

**Table 9.7. Accident Cost by Type.**

<b>Accident Type</b>	<b>Cost (\$2020)</b>
Fatality Accident	\$9,867,638
Injury Accident	\$135,886
Property Damage Only (PDO) Accident	\$4,523

Note: Costs from 2020 USDOT BCA Guidance document, inflated to \$2020.

**Table 9.8. Cost Elements Utilized in Economic Evaluation.**

<b>Cost Element</b>	<b>Description</b>	<b>Base-Case Value</b>	<b>Scenario's Value</b>	<b>Source</b>
<b>Vehicle Configuration</b>				
Fuel Savings	Fuel efficiency savings accrued from truck platooning. This project used 3S2 trucks platooned at a 50-foot gap.	N/A	7% reduction	Assumed 7% based on the research project results (110, 111)
Fuel Cost	2019 Texas average diesel fuel cost inflated to \$2020.	\$2.848	\$2.848	EIA (112)
Environmental Costs	Reduced environmental costs from VOC, NOX, SOX, and PM due to fuel efficiency savings.	N/A	7% reduction	Costs from USDOT BCA Guidance (113) inflated to \$2020, reduction based on fuel reduction
Commodity Profile	Profile based on all freight originating and ending in Texas.			FHWA Freight Analysis Framework
Truck Technology Costs	Automation cost from Slowik and Sharpe (114) inflated to \$2020.	N/A	Short term: \$14,053 Midterm and long term: \$25,102	Slowik and Sharpe (114)
<b>Vehicle Operational Environment</b>				
HOS Break Costs	30-minute break assumed at TxDOT rest area; 10-hour break assumed at private truck stop.	\$20 per truck	Short term & midterm: \$20 per truck Long term: —	Truck parking costs from online review of private truck stop fees
Transfer Port Cost	User fee associated with utilizing transfer port.	N/A	Midterm: \$25 per truck	Assumed to be similar to truck parking costs
<b>Safety &amp; Labor</b>				
Driver Wages	Long-haul and short-haul driver wages.	Long haul: \$29.01 Short haul: \$20.52	Long haul: \$29.01 Short haul: \$20.52	US Bureau of Labor Statistics and ATRI
Insurance Costs	No consensus in literature regarding insurance premiums, so levels maintained for this analysis.	N/A	N/A	
Accidents	Change in accidents based on literature. Assumed reduction in accidents less in short- and midterm; full impact in long term.	N/A	Short term: 10% of impact Midterm: 25% of impact Long term: 100% of impact	Bracy et al. (115)
<b>Infrastructure</b>				
Bridge Costs	Bridge costs grow at truck growth rate.			TTI Analysis
Pavement Costs	Pavement costs grow at truck growth rate.			TTI Analysis

### *Bridge Costs*

The approach for the bridge economic analysis was to utilize the bridge prioritization results previously calculated under Task 4. In this previous task, a high-level evaluation was performed on all Texas bridges likely to foresee future truck platoon loading. The study considered a wide array of truck platoon configurations with different truck types, truck spacing, and number of trucks within a platoon. For each truck platoon configuration, a PR was calculated (for each bridge) that accounts for the bridge capacity along with the condition. Ideally, bridges should have a PR greater than 1.0.

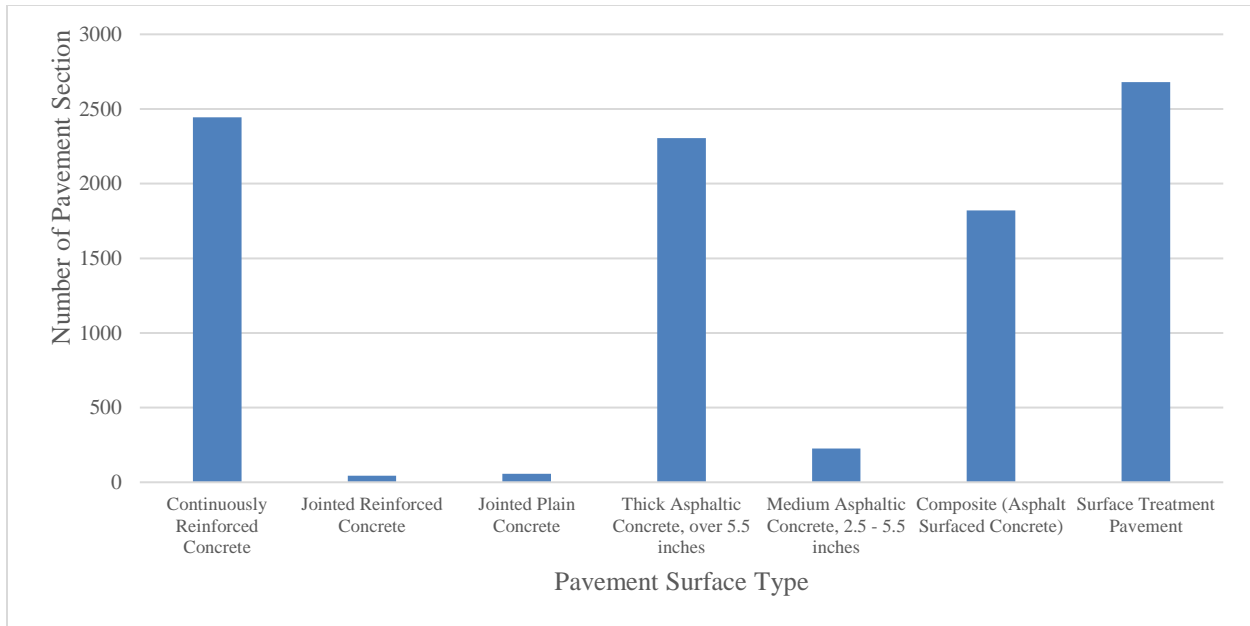
For the bridge economic analysis, a base case (single truck) and a truck platoon case were considered. The purpose was to estimate the financial increase for future truck platoon loading compared to that from the current single trucks. The truck selected for the analysis was the five-axle AASHTO 3S2 (72,000-lb gross weight). For the truck platoon case, a spacing of 50 ft was chosen, which was based on the literature. PR thresholds were established to identify the bridges along the corridor that were candidates for replacement ( $PR \leq 0.7$ ) and rehabilitation/hardening ( $0.7 < PR \leq 0.9$ ). This process resulted in an estimated seven additional bridges in need of replacement and 35 additional bridges in need of rehabilitation/hardening to accommodate future truck platoons.

The estimated cost associated with the added bridge interventions was based on TxDOT fiscal year 2018 average unit costs. The 2018 average bridge replacement cost was \$71.50 per square ft (SF) of deck. Only 50 percent of this cost was estimated for bridge rehabilitation/hardening. The deck area of each bridge was obtained from the NBI database. The additional deck area for future truck platoon loading was calculated as 75,130 SF and 770,289 SF for replacement and rehabilitation/hardening, respectively. The result was approximately \$33,000,000 in additional bridge costs along this corridor.

### *Pavement Costs*

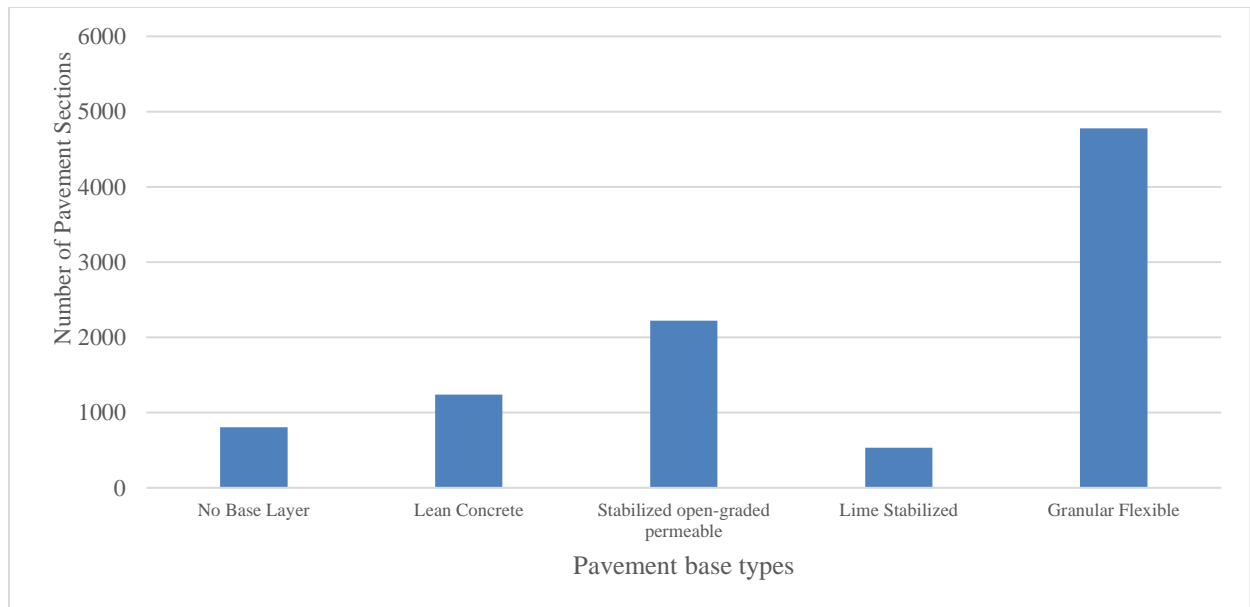
The main data used for the analysis were obtained from the TxDOT Roadway Inventory (116). (available at <https://gis-txdot.opendata.arcgis.com/datasets/txdot-roadway-inventory>).

**Pavement Surface Type:** Based on the attribute table of the TxDOT Roadway Inventory, a histogram for pavement surface types in the study region was obtained. There are more than 9,000 roadway sections, which were chosen as the unit for the analysis (as pavement sections). Surface flexible pavement types include some thick AC, composite asphalt, and surface-treated asphalt. The main surface-rigid pavement type in this region is CRCP (see Figure 9.5 for details).



**Figure 9.5. Pavement Surface Type Histogram for the Study Region.**

**Pavement Base Type:** Similar to the pavement surface, a histogram for pavement base was obtained (see Figure 9.6). The dominant base type in the study region is granular flexible base, although lean concrete base, stabilized open-graded permeable base, and lime-stabilized base are also present. About 10 percent of the sections have no base layer.



**Figure 9.6. Pavement Base Type Histogram for the Study Region.**

In order to identify the main surface and base combination, a histogram was obtained (see Appendix B). Performance for all main observed surface-base combinations were simulated under different scenarios.



**Pavement Performance Prediction Based on the Surface and Base Type Combination:** A high-level pavement performance evaluation was performed based on all major pavement type combinations along the El Paso to Texarkana study corridor. In order to obtain reasonable prediction for these wide array of pavement types, the inputs of analysis were carefully selected from the LTPP database based on the criteria of functional class of pavement, traffic level, and pavement configuration.

First, the IH were screened out from the LTPP database for Texas. Then, the typical range of traffic level for IH was obtained according to the attribute table of the TxDOT Roadway Inventory. The interstate sections in the LTPP database were sorted out according to the traffic level that is close to the target pavement on I-10, I-20, and I-30. Finally, the target pavement configurations were selected from the filtered candidates that meet the first two requirements mentioned above. Therefore, the pavement sections from the LTPP database were sorted out with similar traffic levels and identical pavement configurations, which represent the typical pavement type combinations:

- Thick AC + granular base.
- Thick AC + open-graded base.
- Thick AC + lean concrete base.
- Thick AC + treated base.
- Medium AC + granular base.
- Medium AC + open-graded base.
- AC+CRCP + lime-treated base.
- AC+CRCP + lean concrete base.
- AC+CRCP + open-graded base.
- AC+CRCP + granular base.
- JPCP + granular base.
- CRCP + lime-treated base.
- CRCP + lean concrete base.
- CRCP + granular base.
- CRCP + open-graded base.

For asphalt surface pavement combinations, BUC, rutting, and TDC performance were evaluated. For concrete pavements, faulting (JPCP), transverse cracking (JPCP), and punchout (CRCP) performance were analyzed. The approaches adopted in this analysis were presented under Task 4. The rutting, BUC, and TDC predictions for flexible pavements are shown in figures in Appendix B, along with the faulting and transverse cracking performance predictions for JPCP and CRCP pavements. Both WW and non-WW cases were considered and analyzed for all scenarios, with 2.4 percent and 3.5 percent traffic growth, respectively.

**Estimation of the Unit Rehabilitation Cost:** Different types of pavements need different intervention strategies to optimize their performance during their lifecycle. The type of maintenance or rehabilitation practices used on concrete pavements tend to be different from those used on asphalt pavements. Therefore, the cost associated with the rehabilitation of each type of pavement can be significantly different. In addition, the cost can also vary based on time and location. Therefore, this study’s researchers collected the historical maintenance (for the years 2017, 2018, and 2019) and rehabilitation cost for IH and used it to estimate the unit cost for rehabilitating the concrete and asphalt pavements (see Table 9.9).

**Table 9.9. Rehabilitation Cost Estimation for Two Types of Pavements.**

<b>Pavement Surface Type</b>	<b>Number of Historical Rehabilitation/Resurfacing Projects</b>	<b>Average Unit Cost for Rehabilitation \$/(lane miles)</b>
Asphalt (flexible)	19	22/1617
Concrete (rigid)	6	51/3972

**Estimation of Increase in Rehabilitation Cost Due to Platooning:** This study simulated the temporal performance of two types of pavements with different surface and base configurations under the projected freight demand scenarios. For flexible pavements, rutting, TDC, and BUC were estimated for 10 possible configurations of surface and base types. When rutting and BUC were used, none of the pavement types reached the rehabilitation threshold during the analysis period (30 years). For TDC, the time taken for crack initiation to develop under different scenarios are presented in Appendix B.

For different types of rigid pavements, faulting (JPCP) and punchout numbers (CRCP) were used to estimate the time it takes to reach the rehabilitation threshold. It is worth mentioning that none of the CRCP pavement sections reaches the punchout number threshold for rehabilitation under different scenarios and traffic configurations. For both flexible and rigid pavements, the number of rehabilitation times are estimated by dividing the analysis time period (30 years) by the estimated service life of the corresponding pavement. The summary of the rehabilitation cost calculations under different scenarios are presented in Table 9.10.

**Table 9.10. Rehabilitation and Resurfacing Cost Estimation under Different Scenarios.**

Pavement Section Details				Rehab Cost			
				2.4% Growth Scenario		3.5% Growth Scenario	
Pavement Type	Surface-Base Combinations	Count	Lane Miles	no platoon	platoon	no platoon	platoon
Asphalt (Flexible)	Thick AC granular base	1,722	1,683	\$462,581,558	\$474,951,099	\$479,633,429	\$491,861,446
	Thick AC open-graded base	179	209	\$54,207,570	\$61,706,927	\$56,619,254	\$64,161,504
	Thick AC lean concrete base	47	35	\$11,261,339	\$16,010,754	\$11,759,679	\$16,801,983
	Thick AC treated base	0	0	\$0	\$0	\$0	\$0
	Medium AC granular base	170	99	\$55,418,475	\$58,532,984	\$56,273,992	\$60,087,431
	Medium AC open-graded base	55	29	\$8,980,386	\$11,814,294	\$9,391,140	\$12,463,514
	AC CRCP lime-treated base	0	0	\$0	\$0	\$0	\$0
	AC CRCP lean concrete base	684	714	\$305,774,057	\$498,488,798	\$320,866,353	\$502,181,308
	AC CRCP open-graded base	1,099	1,011	\$405,842,153	\$685,091,342	\$425,902,792	\$696,450,369
	AC CRCP granular base	11	5	\$2,239,983	\$3,599,633	\$2,330,627	\$3,642,072
Concrete (Rigid)	JPCP granular base	53	32	\$16,425,517	\$16,991,914	\$16,425,517	\$18,952,520
	CRCP lime-treated base	0	0	\$0	\$0	\$0	\$0
	CRCP lean concrete base	505	449	\$0	\$0	\$0	\$0
	CRCP granular base	710	646	\$0	\$0	\$0	\$0
	CRCP open-graded base	752	658	\$0	\$0	\$0	\$0
			Total cost	\$1,322,731,038	\$1,827,187,744	\$1,379,202,783	\$1,866,602,147
			Increase due to platooning	<b>\$504,456,706</b>		<b>\$487,399,364</b>	

## **BENEFIT-COST ANALYSIS**

Using the cost elements discussed in Chapter 4, the research team conducted a benefit-cost analysis to determine the impacts of truck platooning on the study corridor. The analysis consisted of infrastructure costs to TxDOT, safety and environmental benefits to society, operational benefits to truck companies, and freight benefits to businesses. Thus, the results of the analysis are presented as costs to TxDOT compared to benefits to businesses, consumers, and society.

The analysis used a baseline scenario representing the status quo, which is compared to a project scenario with truck platooning. The costs in the truck platooning scenario for each element are subtracted from the baseline scenario to generate the project costs and benefits. The analysis was conducted twice using a high and low truck growth rate, thereby giving a range of possible results. The analysis was conducted using a 3% discount rate, and all costs and benefits were discounted to 2020.

- Costs.
  - Increased Pavement Costs.
  - Increased Bridge Costs.
- Safety Benefits—Reduced Crashes.
- Environmental Benefits—Reduced Emissions.
- Operational Benefits.
  - Reduced Driver Costs.
  - Reduced Fuel Costs.
  - Reduced Break Costs.
  - Additional Automation Cost—Negative Impact.
- Freight Benefits.
  - Commodity Time Cost Savings.
  - Just in Time Savings.
  - Perishability Savings.

### **Truck Movements**

All costs and benefits in the analysis are based on the number of trucks passing through the study corridor. Therefore, the first step in the analysis was to determine the number of trucks, establish a truck growth rate, and calculate annual VMT, vehicle hours traveled (VHT), and break hours. These elements were calculated for the baseline and project scenarios. In this case, these figures are the same for the base and project scenario, except for break hours. Break hours are reduced by one half in the midterm since there is only one driver, and by 100 percent in the long term since there are no drivers.

Using the methodology discussed in Chapter 2, an initial 2020 truck count of 350 trucks per day, or 127,750 trucks per year, was decided upon. Annual VMT, VHT, and break hours were calculated using these numbers. The corridor break time was estimated at 13 hours per truck, which includes two 30-minute breaks, one 10-hour break, and an extra two hours of time associated with diverting to the break location, parking, etc. VHT, VMT, and break hours were then increased by the truck growth rate to provide a number for each analysis year.

**Annual VHT** = (Corridor Travel Time) \* (Annual Trucks).

**Annual VMT** = (Corridor Distance) \* (Annual Trucks).

**Annual Break Hours** = (Annual Trucks) \* (Corridor Break Time).

**Corridor Break Time** = 13 hours.

**Truck Growth Rate Low** = 2.4 percent.

**Truck Growth Rate High** = 3.5 percent.

### **Infrastructure Costs**

Infrastructure costs represent the pavement and bridge costs that increase due to platooning. These costs will be borne by TxDOT and make up the cost side of the benefit-cost analysis. The infrastructure cost calculations were discussed in detail in the previous chapter. These calculations resulted in a total cost over the entire analysis period.

It was necessary to break the infrastructure costs down into annual costs in order to apply the discount rate, which was done by solving for an initial annual cost so that when the truck growth rate was applied to it, the sum of the years would equal the total cost previously calculated. This exponential growth method was used so that the growth in costs would track with truck traffic growth. Simply dividing the total cost by the number of analysis years would have overestimated the costs in the early years, and overestimated the costs in the later years, substantially changing the results once they had been discounted.

Once annual infrastructure costs were estimated, the project costs were subtracted from the baseline costs to show an annual cost to TxDOT. The discount rate was then applied to these annual costs, and then the annual costs were summed to show a total project cost. The project costs for both the high and low truck growth scenarios are shown in Table 9.11.

**Table 9.11. Infrastructure Costs Low Growth.**

<b>Infrastructure Cost</b>	<b>Undiscounted Cost</b>	<b>Low-Growth Discounted Cost</b>	<b>High-Growth Discounted Cost</b>
Pavement Cost	\$504,457,000	\$312,817,000	\$305,594,000
Bridge Cost	\$32,910,000	\$20,407,000	\$19,936,000
Total Cost	\$537,367,000	\$333,224,000	\$325,530,000

**Safety Benefits**

Safety benefits are a benefit to road users generated by a reduction in crashes in the platooning scenario. The analysis included fatality crashes, injury crashes, and property damage only (PDO) crashes. It was assumed that full automation would reduce these crashes by the rates discussed in the previous chapter. Furthermore, a percent of this reduction was applied in the short and medium term of the analysis. The short term received 10 percent of this reduction, while the medium term received 25 percent of the reduction. Table 9.12 shows the crash assumptions. Table 9.13 lists the safety benefits.

**Table 9.12. Crash Assumptions.**

<b>Crash Type</b>	<b>Base Crash Rate (per 100 m VMT)*</b>	<b>Short-term Reduction</b>	<b>Midterm Reduction</b>	<b>Long-term Reduction</b>	<b>Cost per Crash</b>
Fatality	1.81	5.09%	12.73%	50.91%	\$9,867,638
Injury	30.9	5.11%	12.77%	51.09%	\$135,886
PDO	105.3	3.8%	9.49%	37.96%	\$4,523

\* Source: <https://www.fmcsa.dot.gov/sites/fmcsa.dot.gov/files/docs/safety/data-and-statistics/461861/lcbbf-2017-final-5-6-2019.pdf>

The crash rate reductions were applied to the base truck crash rates to determine a crash rate for each type of crash in the short-, mid-, and long-term analysis. These rates were then multiplied by the VMT for each year to determine the number of crashes of each type. The number of crashes was then multiplied by cost of that type of crash to determine annual costs for the baseline and project scenarios, which were then discounted. The difference in the lower project cost and the higher baseline cost is the safety benefit generated by platooning. The discount rate significantly affects this calculation because most of the safety benefits are generated in the long-term period of the analysis.

$$\text{Number of Crashes} = (\text{VMT}/100,000,000) * (\text{Crash Rate}).$$

$$\text{Crash Cost} = (\text{Number of Crashes}) * (\text{Cost}).$$

**Table 9.13. Safety Benefits.**

<b>Safety Benefit</b>	<b>Total Undiscounted Benefit</b>	<b>Total Discounted Benefit</b>
Low Growth	\$429,399,000	\$231,217,000
High Growth	\$536,093,751	\$284,885,000

## Environmental Benefits

Environmental benefits are a benefit to society generated by a reduction in vehicle emissions. The emissions assumptions are shown in Table 9.14. This analysis quantifies the benefits of reduced volatile organic compounds (VOCs), nitrogen oxides (NOx), sulfur oxides (SOx), and particulate matter (PAM). It was assumed that truck platooning will increase fuel efficiency in the project scenario by 7 percent, thus reducing emissions accordingly.

**Table 9.14. Emissions Assumptions.**

<b>Emission Type</b>	<b>Base Emission Rate (Tons per VMT)</b>	<b>Project Emissions Rate (Tons per VMT)</b>	<b>Emission cost per Ton</b>
VOC	0.0000004387	0.0000004100	\$2,159
NOx	0.0000039099	0.0000036541	\$8,840
SOx	0.0000000107	0.0000000100	\$51,497
PAM	0.0000002712	0.0000002535	\$398,098

The emissions rate was multiplied by VMT and then by the emission cost per ton for the baseline and project scenarios. This generated a baseline and project emissions cost. These were discounted, and the difference between them was the total environmental benefit, as shown in Table 9.15.

$$\text{Environmental Cost} = (\text{VMT}) * (\text{Emission Rate}) * (\text{Emission Cost})$$

**Table 9.15. Environmental Benefit Analysis.**

<b>Environmental Benefit</b>	<b>Total Undiscounted Benefit</b>	<b>Total Discounted Benefit</b>
Low Growth	\$196,887,161	\$122,082,000
High Growth	\$235,272,000	\$142,512,000

## Operations Benefits

Operations benefits are made up of the savings generated by trucking companies in the project scenario. These savings include reduced driver costs, reduced fuel costs, reduced costs from idling during breaks, and reduced break costs, shown in Table 9.16. Additionally, automation costs were calculated in this section, creating a disbenefit to trucking companies. These benefits (Table 9.17) are captured by trucking companies as reduced costs but also likely translate into reduced costs for consumers since the trucking industry is highly competitive.

**Table 9.16. Undiscounted Operations Benefit Components.**

Operations Benefit Component*	Low-Growth Benefit	High-Growth Benefit
Driver Costs	\$1,554,112,000	\$1,929,930,000
Fuel Costs	\$137,555,000	\$164,336,000
Idling and Break Costs	\$1,074,620,000	\$1,369,917,000
Automation Costs	-\$187,122,000	-\$225,376,000

\* Undiscounted.

**Table 9.17. Total Operations Benefits.**

Operations Benefit	Total Undiscounted Benefit	Total Discounted Benefit
Low Growth	\$2,579,162,000	\$1,360,334,000
High Growth	\$3,238,807,000	\$1,690,122,273

*Driver Costs*

Most of the benefit in this category was generated by reducing driver costs. Switching to one driver per truck pair in the midterm and then to zero drivers in the long-term portion of the analysis significantly reduces driver costs. Base scenario driver costs were calculated by multiplying VHT by the driver cost per hour then by the number of drivers per truck. The same was done in the project scenario where the midterm has one driver per two trucks, then zero in the long term. In the midterm, it is assumed that a portion of the trip utilizes one short-haul driver per truck with a lower wage. The remainder of the trip utilizes one driver per two trucks.

$$\text{Driver Cost} = (\text{VHT}) * (\text{Drivers per Truck}) * (\text{Driver Hourly Wage})$$

*Fuel Costs*

Fuel savings are generated by the difference in fuel consumption in the base and project scenarios. Table 9.18 summarizes the fuel cost assumptions. The project scenario assumes a 7% reduction in fuel consumption due to platooning. Fuel costs were calculated by multiplying arterial and highway fuel consumption by arterial and highway VHT and then multiplying by the diesel price. Fuel cost assumptions are shown below.

**Table 9.18. Fuel Cost Assumptions.**

Fuel Cost Assumptions	Base	Project
Arterial Fuel Consumption (Gallons per Hour)	6.25	5.84
Highway Fuel Consumption (Gallons per Hour)	10.16	9.49
Diesel Cost (\$2020)	\$2.848	\$2.848

$$\text{Fuel Cost} = (((\text{Arterial VHT}) * (\text{Arterial Fuel Consumption})) + ((\text{Highway VHT}) * (\text{Highway Fuel Consumption}))) * (\text{Diesel Cost})$$



### *Idling and Break Costs*

Idling savings are generated by reducing truck idling time during required breaks. During these breaks, it was assumed that certain truck costs were incurred, including truck capital costs, maintenance costs, insurance, and permits. Totaled, these equal \$22.04 per hour, as shown in Table 9.19. This cost becomes a benefit in the long-term portion of the analysis because driver breaks are eliminated. Idling cost also includes idle fuel consumption, which is reduced by 50 percent in the midterm since only one truck needs to idle and is eliminated in the long term.

Each 10-hour break and transfer terminal in the midterm only was also assumed to have a cost associated with using the facility. This cost was simply multiplied by the number of breaks or transfers to generate a total.

**Table 9.19. Idle Truck Assumptions.**

<b>Idling Cost Assumptions</b>	<b>Value</b>
Hourly Idle Truck Cost	\$22.04
Hourly Idle Fuel Consumption (Gallons per Hour)	0.80
10 Hour Break Cost	\$20.00
Transfer Port Cost	\$25.00

$$\text{Idle Truck Cost} = (\text{Hourly Idle Cost}) * (\text{Break Hours})$$

$$\text{Idle Fuel Cost} = (\text{Hourly Idle Fuel Consumption}) * (\text{Break Hours}) * (\text{Diesel Price})$$

$$\text{Break Cost} = (\text{Number of Breaks}) * (\text{Break Cost})$$

### *Automation Cost*

Automation costs were included as a disbenefit in the Operations Benefits Section. This is the cost to trucking companies to equip their trucks with truck platooning and automation equipment. This cost was assumed to be \$14,053 in the short term and \$25,102 in the midterm and long term. It was assumed that the serviceable life of a truck was 600,000 mi, so the automation cost was divided by this to create a per mile automation cost of \$0.023 per mile in the short term and \$0.042 per mile in the midterm and long term.

$$\text{Automation Cost} = (\text{Automation Cost per Mile}) * (\text{VMT})$$

### **Freight Cost Savings**

Freight time costs represent the costs to industries that produce or consume the freight goods on the trucks moving through the project corridor. The freight time cost savings consist of commodity time costs, perishability costs, and just in time costs. These factors were calculated using a methodology developed by Fitzroy et al. (117). A freight profile was developed using FHWA's Freight Analysis Framework. This profile is statewide and not specific to the corridor.

It provided a cost per ton for each commodity on the road in Texas, as well as a percentage of trucks carrying each commodity.

First, the change in VHT was calculated by subtracting the project VHT from the base VHT. Second, commodity time cost for each commodity was calculated by multiplying the tons per vehicle by the commodity percent of freight, then by the commodity cost per hour and the total change in VHT. This calculation repeats for each commodity moving through the project corridor. The commodity cost per hour for each commodity was calculated through the Economic Development Research Group (EDR’s) methodology, which assumes an hourly return on capital of 10 percent divided by 5,400, with 5,400 being the estimated number of productive hours in a year. This amount was then multiplied by the cost of the good as reported at the port of entry to give the commodity cost per hour. This amount represents an hourly opportunity cost of the good not being at its destination.

The perishability cost was also estimated based on the change in VHT using EDR’s methodology. Perishability cost is the loss in value from goods spoiling during transport. This cost applies to goods that need to be fresh at their destination, such as fruits and vegetables. A calculation similar to the commodity time cost calculation was used. Change in VHT was multiplied by the tons per vehicle, and then by the commodity percent of freight. This amount was then multiplied by the perishability cost factor, and then by the perishability commodity factor. A perishability cost factor of \$0.001 per buffer hour was used based on EDR’s methodology. Perishability commodity factors were also assigned to goods based on EDR methodology.

Just in time cost was calculated in the same way, using a just in time cost factor and a just in time commodity factor in place of the perishability factors. Just in time commodity factors were used based on EDR methodology, with a just in time cost factor of \$0.002. The total freight benefits are shown in Table 9.20.

**Table 9.20. Freight Benefits.**

<b>Operations Benefit</b>	<b>Total Undiscounted Benefit</b>	<b>Total Discounted Benefit</b>
Low Growth	\$976,033,000	\$492,118,000
High Growth	\$1,241,828,000	\$622,464,000

**Total Freight Time Cost** = (Commodity Time Cost) + (Just in Time Cost) + (Perishability Cost)

**Commodity Time Cost**= (Change in VHT) \* (Tons per Vehicle) \* (Commodity Percent of Freight) \* (Commodity Cost per Hour)

**Commodity Cost per Hour** = (Commodity Price) \* (0.1/5400)

**Just in Time Cost** = (Change in VHT) \* (Tons per Vehicle) \* (Commodity Percent of Freight) \* (Just in Time Cost Factor) \* (Just in Time Commodity Factor)

**Perishability Cost** = (Change in VHT) \* (Tons per Vehicle) \* (Commodity Percent of Freight) \* (Perishability Cost Factor) \* (Perishability Commodity Factor)

## BCA Results

The discounted net present value was \$1,872,527,000 in the low-growth scenario (Table 9.21) and \$2,414,454,000 in the high-growth scenario (Table 9.22). The benefit-cost ratio was 6.62:1 in the low-growth scenario and 8.42:1 in the high-growth scenario, which means that for every \$1 spent, \$8.42 of benefits are received.

**Table 9.21. Low-Growth Scenario Results.**

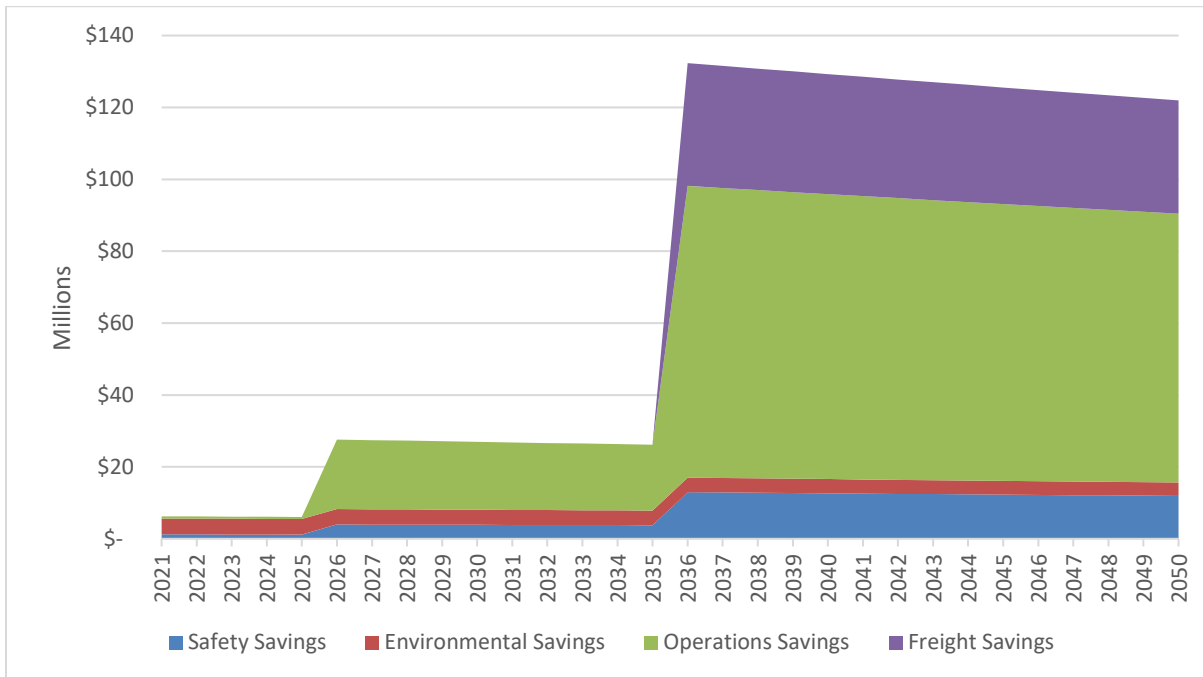
<b>Low-Growth Scenario Results</b>	<b>Undiscounted</b>	<b>Discounted</b>
Total Pavement Cost	\$504,457,000	\$312,817,000
Total Bridge Cost	\$32,910,000	\$20,407,000
<b>Total Cost</b>	<b>\$537,367,000</b>	<b>\$333,224,000</b>
Total Safety Benefit	\$429,399,000	\$231,217,000
Total Environmental Benefit	\$196,887,161	\$122,082,000
Total Operations Benefit	\$2,579,162,000	\$1,360,334,000
Total Freight Benefit	\$976,033,000	\$492,118,000
<b>Total Benefit</b>	<b>\$4,181,481,000</b>	<b>\$2,205,751,000</b>
<b>Net Present Value</b>	<b>\$3,644,115,000</b>	<b>\$1,872,527,000</b>
<b>Benefit-Cost Ratio</b>	<b>7.78:1</b>	<b>6.62:1</b>

**Table 9.22. High-Growth Scenario Results.**

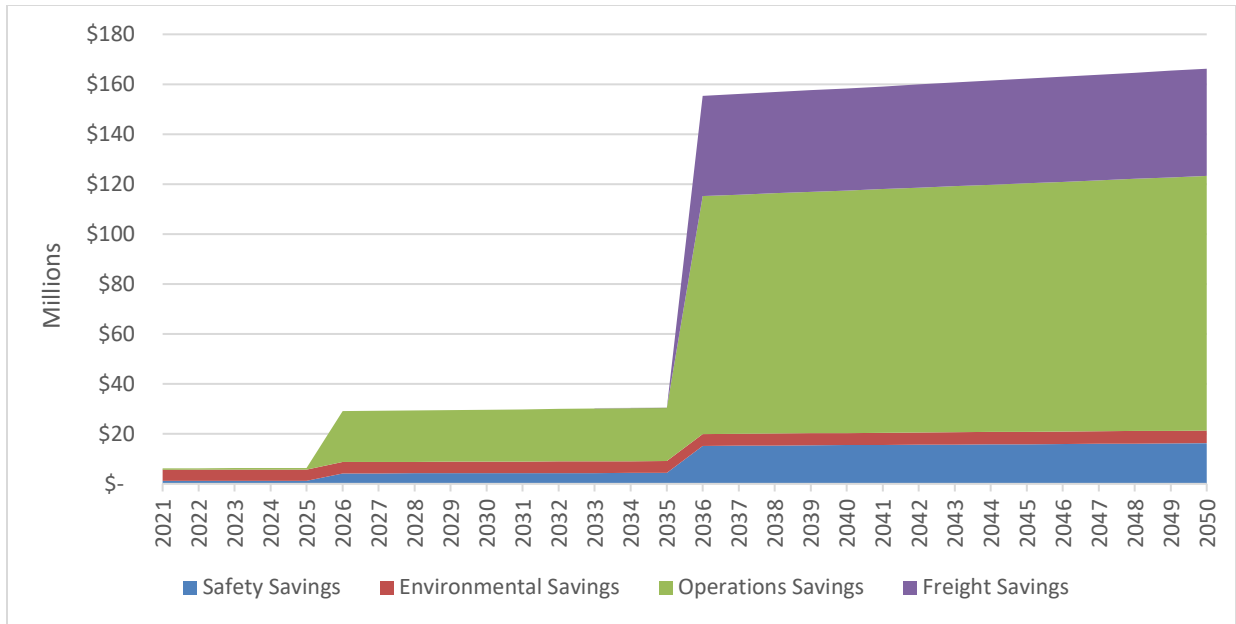
<b>High-Growth Scenario Results</b>	<b>Undiscounted</b>	<b>Discounted</b>
Total Pavement Cost	\$504,457,000	\$305,594,000
Total Bridge Cost	\$32,910,000	\$19,936,000
<b>Total Costs</b>	<b>\$537,367,000</b>	<b>\$325,530,000</b>
Total Safety Benefit	\$536,093,751	\$284,885,000
Total Environmental Benefit	\$235,272,000	\$142,512,000
Total Operations Benefit	\$3,238,807,000	\$1,690,122,273
Total Freight Benefit	\$1,241,828,000	\$622,464,000
<b>Total Benefit</b>	<b>\$5,252,001,000</b>	<b>\$2,739,983,000</b>
<b>Net Present Value</b>	<b>\$4,714,634,000</b>	<b>\$2,414,454,000</b>
<b>Benefit-Cost Ratio</b>	<b>9.77:1</b>	<b>8.42:1</b>

Figure 9.7 and Figure 9.8 show the benefit streams of the analysis over time and clearly show the impact that the short-, mid-, and long-term assumptions have on the results. Safety benefits increase as the level of automation increases. Environmental benefits remain similar throughout because the emissions reduction occurs in the short term and stays constant throughout. The operations benefit is very low until the midterm when the number of drivers needed is reduced

due to platooning. This element becomes more pronounced in the long term when there are no drivers due to full automation. Additionally, breaks are no longer needed, further increasing this benefit. The freight benefit only exists in the long term because the elimination of breaks allows freight to reach its destination sooner. Finally, in the low-growth scenario, benefits generally decrease over time because the truck growth rate of 2.4 percent is lower than the 3 percent discount rate. This decrease is not the case in the high-growth scenario, which uses a 3.5 percent growth rate.



**Figure 9.7. Low-Growth Scenario Discounted Benefits Over Time.**



**Figure 9.8. High-Growth Scenario Discounted Benefits Over Time.**

## ECONOMIC IMPACT ANALYSIS

The project team estimated the economic impacts using the input-output model IMPLAN. The operational cost savings calculated in the BCA represent the out-of-pocket savings to the trucking industry. These savings will be reinvested in the industry, distributed to shareholders and employees, and/or passed on to the customer and consumers. The economic impact analysis shows the effects of these additional dollars on the Texas economy. The estimated results include:

- Employment.
- Labor income—including both employee and proprietor income values.
- Value added—including labor income, other property income, and any indirect business taxes.
- Output—the value of industry production in the form of value added plus any intermediate expenditures on services or goods from another industry used to produce a product for a different industry (i.e., materials needed).

Each of these estimated economic impacts are categorized as direct, indirect, or induced. Direct impacts result from the initial change in expenditures to the truck transportation industry; indirect impacts arise from the operations of the truck transportation industry (i.e., suppliers); and induced impacts are from household spending of direct and indirect wages.

For this analysis, the direct jobs and income were reported as zero in the midterm and long-term scenarios to signal the reduction of drivers in the case study example. This finding reflects the loss of direct employment and does not calculate a direct employment gain based on the

transportation savings. However, the increase in production dollars to the truck transportation industry will result in indirect and induced jobs. The economic analysis was performed for 2021, 2026, and 2036. These years represent the first operational year of each scenario: near term, midterm, and long term. Using the 2.4 percent growth factor, Table 9.23 shows the estimated economic impacts for each of the years examined. All monetary results are in 2020 dollars.

**Table 9.23. Estimated Economic Impact Summary (2.4 percent growth factor).**

Impact Type	Employment	Labor Income	Value Added	Output
<b>Start of Near-Term Scenario 2021</b>				
Direct Effect	3.8	\$230,214	\$272,650	\$604,060
Indirect Effect	2	\$136,912	\$226,555	\$414,397
Induced Effect	2.3	\$113,237	\$198,594	\$342,818
Total Effect	8.1	\$480,364	\$697,799	\$1,361,275
<b>Start of Midterm Scenario 2026</b>				
Direct Effect	0	\$0	\$1,359,038	\$19,345,345
Indirect Effect	65.4	\$4,384,677	\$7,255,536	\$13,271,293
Induced Effect	27.1	\$1,360,315	\$2,385,077	\$4,118,760
Total Effect	92.5	\$5,744,992	\$10,999,650	\$36,735,399
<b>Start of Long-Term Scenario 2036</b>				
Direct Effect	0	\$0	\$5,701,108	\$81,152,948
Indirect Effect	274.4	\$18,393,544	\$30,436,681	\$55,672,543
Induced Effect	113.5	\$5,706,468	\$10,005,302	\$17,278,032
Total Effect	388	\$24,100,012	\$46,143,091	\$154,103,524

Indirect and induced impacts affect industries other than the truck transportation industry. The top 10 industries impacted (ranked by output) are listed in Table 9.24. Oil and gas industries are impacted, as well as personal service industries such as real estate, rent, banking, retail, and insurance.

**Table 9.24. Top 10 Industries Impacted.**

	Near Term	Midterm	Long Term
1	Truck transportation	Truck transportation	Truck transportation
2	Petroleum refineries	Petroleum refineries	Petroleum refineries
3	Wholesale trade	Scenic and sightseeing transportation and support activities for transportation	Scenic and sightseeing transportation and support activities for transportation
4	Scenic and sightseeing transportation and support activities for transportation	Wholesale trade	Wholesale trade
5	Owner-occupied dwellings	Couriers and messengers	Couriers and messengers
6	Real estate	Extraction of natural gas and crude petroleum	Extraction of natural gas and crude petroleum
7	Couriers and messengers	Real estate	Real estate
8	Insurance carriers	Insurance carriers	Insurance carriers
9	Extraction of natural gas and crude petroleum	Postal service	Postal service
10	Monetary authorities and depository credit intermediation	Owner-occupied dwellings	Owner-occupied dwellings

In addition to direct, indirect, and induced impacts, IMPLAN reports the tax impacts of the monetary increase to the truck transportation industry. Table 9.25 shows the total tax impact at the state and local level and the federal level.

**Table 9.25. Estimated Tax Impact Summary (2.4 percent growth factor).**

Description	Total Tax
<b>Start of Near-Term Scenario 2021</b>	
Total State and Local Tax	\$41,322
Total Federal Tax	\$94,462
<b>Start of Midterm Scenario 2026</b>	
Total State and Local Tax	\$909,252
Total Federal Tax	\$1,304,488
<b>Start of Long-Term Scenario 2036</b>	
Total State and Local Tax	\$3,814,279
Total Federal Tax	\$5,472,278

Economic impacts were also calculated for the higher 3.5 percent growth scenario. Table 9.26 summarizes the economic impacts for each of the three years examined.

**Table 9.26. Estimated Economic Impact Summary (3.5 percent growth factor).**

Impact Type	Employment	Labor Income	Value Added	Output
<b>Start of Near-Term Scenario 2021</b>				
Direct Effect	3.8	\$230,214	\$272,650	\$604,060
Indirect Effect	2	\$136,912	\$226,555	\$414,397
Induced Effect	2.3	\$113,237	\$198,594	\$342,818
Total Effect	8.1	\$480,364	\$697,799	\$1,361,275
<b>Start of Midterm Scenario 2026</b>				
Direct Effect	0	\$0	\$1,433,625	\$20,407,070
Indirect Effect	69	\$4,625,320	\$7,653,739	\$13,999,658
Induced Effect	28.6	\$1,434,973	\$2,515,976	\$4,344,808
Total Effect	97.6	\$6,060,293	\$11,603,341	\$38,751,537
<b>Start of Long-Term Scenario 2036</b>				
Direct Effect	0	\$0	\$6,692,108	\$95,259,421
Indirect Effect	322.2	\$21,590,815	\$35,727,360	\$65,349,866
Induced Effect	133.3	\$6,698,399	\$11,744,481	\$20,281,399
Total Effect	455.4	\$28,289,215	\$54,163,949	\$180,890,687

Tax impacts were also reported for the higher 3.5 percent growth rate in Table 9.27, which shows an increase from \$3.8 million to \$4.5 million at the beginning of the long-term scenario for state and local taxes and an increase from \$5.5 million to \$6.4 million for federal taxes.

**Table 9.27. Estimated Tax Impact Summary (3.5 percent growth factor).**

Description	Total Tax
Start of Near-Term Scenario 2021	
Total State and Local Tax	\$41,322
Total Federal Tax	\$94,462
Start of Midterm Scenario 2026	
Total State and Local Tax	\$959,155
Total Federal Tax	\$1,376,083
Start of Long-Term Scenario 2036	
Total State and Local Tax	\$4,477,299
Total Federal Tax	\$6,423,500

Overall, the 2.4 percent growth rate results in an estimated \$1.4 million in economic output for the near-term scenario in 2021, which increases annually to \$36.7 million for the midterm scenario in 2026, and to \$154.1 million for the long-term scenario in 2036. The 3.5 percent growth rate results in an estimated \$38.8 million for the midterm scenario in 2026 and \$180.9 million for the long-term scenario in 2036.



## **CHAPTER 10. CONCLUSIONS AND RECOMMENDATIONS**

This project assessed the potential impacts, benefits, and impediments to the introduction of automated trucks and truck platooning on Texas highway infrastructure. The assessment included but was not limited to the following:

- Identification of any needed infrastructure hardening decisions and potential changes in road and bridge design specifications.
- Impacts on TFMP and the wider-designated Texas Highway Freight Network.
- Impacts on statewide planning/TTP.
- Impacts on MPO and other local/regional plans.
- Overall impacts on TxDOT's planning process.
- Identification and documentation of national/state/local-level planning/policy impediments and obstacles.
- Potential need for separate/specialized freight transportation facilities.
- Vulnerability analysis at the asset and network levels to understand the wider impact of these new technologies on Texas highway infrastructure.
- Overall infrastructure costs and benefits associated with the introduction of automated and platoon truck technologies on Texas highway infrastructure.

The main research findings and conclusions are summarized as follows.

### **DETERMINATION OF STATE-OF-PRACTICE**

In Task 2, the theoretical and practical foundations of the project were determined by using a literature review and industry engagement. The reviewed documents and literature span the domains of connected and automated truck applications and establishing a driver training program. Other research and development gaps identified during the literature review process are discussed next.

#### **Connected and Automated Truck Applications**

Further testing and understanding of truck platooning and automated truck technologies under various operational conditions are necessary to implement them in the real world successfully. Additional truck testing under various platooning configurations was proposed as follows:

- Truck platooning at close following distances to understand the aerodynamic or other control system impacts.
- Truck platooning tests to understand the difference between trucks and trailers that have different aerodynamic profiles.
- Understanding lane-changing behavior and impacts of cut-ins under various following distances.

- Understanding connected and automated trucks' interaction with other types of vehicles.
- Testing in broader traffic operation settings.
- Automated truck testing in poor weather and low visibility conditions.
- Measuring technical and societal impacts when trucks equipped with CAV technologies are not in a platoon or on automation mode.

Collecting and analyzing data sets large enough to ensure the validity of testing is also important. Further collaboration with trucking associations, trucking companies, and commercial vehicle drivers will be needed to understand particular connected and automated vehicle applications, which need to be incorporated into truck operational configurations.

### **Establish Driver Training Program and Labor Standards**

Within the higher level of CAV technologies, conventional truck drivers' roles might be limited, and completely new roles, like remote operators, may emerge. Therefore, drivers' understanding and qualifications with respect to the vehicle's functionality, capabilities, and limitations are crucial in operating trucks with new automated and connected systems. Also, new technology-based requirements or qualifications are expected to perform new roles (i.e., remote vehicle operations) in an automated truck environment. Such changes will likely require cooperative solutions between TxDOT (in infrastructure design and provision), the Department of Public Safety (in traffic law enforcement and licensing of drivers), the Department of Motor Vehicles (in truck permitting), and other agencies as the technologies continue to evolve.

### **Other Research Needs Identified**

Other research and development gaps identified during the literature review are listed below:

- Development of digital maps with roadway geometric limitations and turning radius restrictions for trucks for highly autonomous vehicle operation.
- Application of scenario analysis techniques and assumptions for long-range plans of autonomous and connected trucks.
- Analysis of the impact of connected and automated technologies on long-term transportation capacity.
- Performance of industry outreach to understand the long-term impact on logistics.
- Analysis of the potential impact of truck platooning on pavement damage.
- Development of a strategy for planners to ensure privacy and allow data sharing for public use of large volumes of new transportation data.
- Assessment of the impact of connected and automated trucks in transport and supply chain network designs.
- Development of specialized solution methods to handle various restrictions related to the connected and automated truck operational configurations.

Detailed research suggestions for each of these areas can be found in NCHRP 231: *Challenges to CV and AV Applications in Truck Freight Operations (13)*. TxDOT must remain engaged in research to address the elements listed that pertain to its primary mission of planning for the movement of people and goods throughout the state. In doing so, it must work cooperatively with local and regional planners, private freight providers, and technology developers to ensure that the transportation system remains not only viable but resilient. Maintaining research in these areas is vital.

## **IMPACTS ON PLANNING AND POLICY**

The objective of Task 3 was to assess the planning and policy impacts on TxDOT that may occur as platooning and automated trucks are introduced on Texas highways under a variety of scenarios that are defined further in other tasks on infrastructure and operational needs. The research team reviewed the planning process of TxDOT, MPOs, and other local/regional level plans. Also, all levels of statewide planning documents, including the TFMP, TTP, MPOs' MTP, and MPO TIPs were cataloged and reviewed. The research team also reviewed strategic planning documents from other states focused on ACV impacts. While pursuing this task, planning and policy impediments and obstacles were identified at national, state, and local levels. The planning impacts on Texas' highway network were also evaluated under the platooning and automated truck scenarios identified and used in Task 6 for the economic analysis.

Often forgotten or delegated to an afterthought in the discussion of the impact of both platooning and automated vehicles are the transportation planning and policy issues associated with implementing their use on existing roadways. Impact assessments on how they might be managed or interact with existing or future infrastructure and other vehicles and broad changes in planning processes and system design may be needed to accommodate both. Previous TxDOT research indicated that these impacts could be broad-ranging, affecting:

- Overall infrastructure costs.
- Freight routing selection and subsequent commodity costs to consumers.
- The need for separate/specialized freight transportation facilities.
- The number and location of intermodal exchange nodes along the highway system.
- The average speeds at which mixed (freight and passenger) traffic may flow—even within a broader AV/CV operating environment.

## **IMPACTS OF PLATOONING AND TRUCK AUTOMATION ON TEXAS INFRASTRUCTURE**

The main objectives of Task 4 included (a) introducing a comprehensive analysis framework for performance evaluation of pavement performance quantified in terms of changes in service life for traditional and autonomous trucks with and without lateral wheel wandering; and (b)

conducting a high-level analytical investigation to identify the impact of future truck platoons on the Texas bridge inventory,

### **Impacts on Texas Pavements**

A comprehensive pavement performance evaluation framework was used to evaluate the influence of truck platooning and automation on the performance of flexible pavements in Texas. Characteristic properties of individual pavements, including pavement structure, traffic, environmental conditions, and material properties were considered in the analysis framework for the evaluation of pavement performance. Asphalt mixture and unbound materials information, together with the environmental inputs, were required in the material models for the prediction of key material properties for the surface layer, base layer, and subgrade, respectively. The environmental inputs were used in the material models to predict the changes in the material properties due to the seasonal variations in temperature and moisture conditions. The pavement response model was used to compute the critical stresses and/or strains in the different layers in the pavement structure due to the application of traffic loading. Traffic data required for the evaluation of the effect of truck platooning on pavement performance included the number of axle load repetitions and distribution of axle load magnitudes for each vehicle class. The predicted stress-strain response and the distribution and magnitude of the axle load configurations were considered for the performance analysis of the individual pavement sections. Next, a series of comprehensive pavement performance analyses were implemented for Texas flexible and rigid pavement sections. Typical pavement distress, including TDC, rutting, and bottom-up fatigue cracking for flexible pavements and faulting and fatigue for rigid pavements were analyzed using state-of-the-art models. By applying the WW coefficients, the effects of truck platooning were simulated and compared to the results in traditional driving conditions. The WW coefficients were calculated by section since the material properties of AC, base, and subgrade layers for each pavement section are different. Once both WW and non-WW conditions were ascertained, the differences between the pavement life and degree of certain distress development were used to quantify the effects of autonomous truck.

### **Impacts on Texas Bridges**

The research began with an overall study of all bridges in the state of Texas using the NBI database. Further analysis and calculations were performed to determine approximate load ratings under different truck platoon configurations for all bridges likely to experience future automated and platoon trucks. Finally, a relative PM was calculated for each bridge, which combines the load rating results and the NBI structural evaluation appraisal ratings. This process allowed the bridges to be categorized from low to high priority for more detailed evaluation.

To be more specific, the primary objective of this part of the study was to prioritize the bridges within the state of Texas for future automated and platoon truck loading. First, the bridges most likely to foresee truck platoons were established by identifying the Texas bridges in the Strategic

Highway Network (STRAHNET), which removes rural bridges where platoons are unlikely. In addition, the scope of the study only focused on prestressed concrete bridges (approximately 70 percent of STRAHNET), so all other structure types were removed (steel bridges were included in the latter half of the study). Then, the following stages of analysis were performed using programs written with Visual Basic and Matlab:

1. Extracting NBI Data.
2. Identify Design Methodology.
3. Calculate Design Live Load Demands.
4. Determine Bridge Capacity and Dead Load Demands.
5. Calculate Truck Platoon Live Load Demands.
6. Calculate Truck Platoon Load Ratings.
7. Bridge Prioritization.

The results, based on the prestressed concrete bridge ratings under a three-truck platoon load (AASHTO Type 3S2 and Florida C5) at 30-ft spacing, reveal the number of bridges under different span lengths, the ORs for all three original design rating methods (ASR, LFR and LRFR), and the converted LRFR ratings. It was clearly shown that the load ratings from the original design methods are well above 1.0 (not accounting for bridge condition). However, converting the original ASR and LFR ratings to LRFR does produce OR ratings below 1.0 for certain span lengths. The converted LRFR ratings were multiplied by the appraisal rating factors to prioritize each bridge into five categories. Intuitively, the larger portion of higher-priority bridges results from the shorter-length platoon trucks, which allow for more condensed loading on a structure at one time. This conclusion is also seen when the truck spacing within a platoon is varied from 30 ft to 50 ft. Analysis of truck platoons spaced at 40 ft yielded a 20 percent to 40 percent reduction in Category 5 bridges (i.e., bridges benefitting from maintenance or rehabilitation actions). Conversely, many of the Category 5 bridges are within this grouping due to their condition (from the NBI appraisal values) and not span length. For better visualization of the findings, the results were exported to Google Earth, which allows TxDOT to see the bridges for each category along any route. The highest concentrations of structures are within the Houston and Dallas areas. Complete results from this analysis are also built into a Microsoft Excel tool, which can conveniently provide the results for a given spatial unit.

### **Other Key Project Findings Affecting Policy and Planning**

The results from the traffic simulation research in Task 4 included the following policy and planning implications:

- **Lane Restriction Policy:** Restricting platooning trucks on the right lane adversely affects freeway performance. Platoons should not be restricted to right lanes only.
- **Traffic Volume Levels:** Corridors with LOS-C or better are best suited for testing platooning. Therefore, initial testing of truck platoons should occur in more rural areas.

- **Lane Change Policy:** The results show that platoons should not be required to move left when approaching the ramp. This process creates unnecessary lane changing at low-volume levels. The results also showed that cooperative lane changing by platoon trucks to accommodate merging vehicles did not improve freeway performance.
- **Auxiliary Lane and Weaving Section Considerations:** Auxiliary lanes tend to improve freeway performance in a truck platooning environment. Thus, it is preferable to select corridors that provide an auxiliary lane for the ramps. The weaving length is the deterring factor when selecting a corridor for truck platooning. Therefore, it is preferable to select corridors with weaving sections that are greater than 1,000 ft in length.
- **Pavement Markings for AV-CV Users:** While well-marked and maintained pavement markings are essential for current operation, they become more critical for AVs using machine vision. Pavement markings serve a critical need in the progression of automated vehicles through the five levels of automation described by SAE and USDOT. In this shared environment, the quality of markings will likely increase rather than decrease in importance.

## **IMPACTS ON THE VULNERABILITY OF THE TEXAS HIGHWAY SYSTEM PAVEMENTS**

In Task 5, impacts of the truck platooning and truck automation on the overall vulnerability of the Texas Highway Freight Network were examined. The methodology consisted of first modeling the Texas Highway Freight Network with a novel, graph-based network model framework comprised of pavement sections and bridges and then performing a network-level vulnerability analysis of the highway freight network pavements and bridges to identify any RSL for the included pavement sections and to study the impacts of different platoon truck configurations on the performance of the included bridges.

### **Impacts of Truck Platooning on the Vulnerability of Texas Pavements**

Because of the large number of pavement sections in the Texas Highway Freight Network, the analysis of pavement vulnerability was based on a detailed analysis using performance data from the FHWA LTPP pavements in Texas. The results from an analysis of the LTPP pavements were then extrapolated to the whole Texas Highway Freight Network based on equivalent AADTT, road type, and pavement type. Corresponding performance indicators for each pavement type were used to estimate the difference in the remaining service life of the pavements under the truck automation and platooning scenario versus the normal truck traffic scenario. Rutting, TDC, and BUC were studied for flexible pavements. Based on the type of rigid (concrete) pavement, examples of performance indicators included fatigue cracking and punchout progression. In the case of flexible pavements, a 22 percent reduction in average service life was observed for TDC, a 21 percent reduction in average service life was observed for BUC, and only a 9 percent reduction in average service life was observed for rutting.

The analysis was not only able to estimate the RSL due to truck automation but also able to identify the pavement sections with the greatest decrease in pavement life. Therefore, the analysis results can serve as a basis for identifying which pavement sections to harden, as well as help to evaluate different hardening options. Thus, two possible pavement hardening scenarios—building dedicated truck lanes and hardening paved surfaces using polymer-modified asphalts—were proposed. The analysis of hardening options also specifically examined the impact of different levels of polymer modification on improving the service life of the pavements. Initial results showed that 3 to 6 percent polymer modification of the asphalt binder could reduce the negative impacts of truck automation on all types of premature asphalt pavement degradation, with the upper range of polymer modification resulting in total negation of all negative effects on cracking and rutting.

### **Impacts of Truck Platooning on the Vulnerability of Texas Highway Bridges**

Out of more than 55,000 bridges in Texas, this study identified about 20,000 bridges in the Texas Highway Freight Network for inclusion in this research. First, a bridge prioritization study was completed. A comprehensive PR index that categorized the overall condition of the bridges was used to quantify each bridge's ability to support truck platoons. A Microsoft Excel tool was developed to conveniently identify bridges that need attention at different spatial scales. The overall impact of platooning was assessed using two different methods: (a) key performance indicators (PR) for the bridges; and (b) full Texas Highway Freight Network-level analysis. The main findings of the bridge vulnerability study included:

- Truck gap spacing has a moderate impact on bridge vulnerability. For example, there was a 33 percent increase in the number of high-priority bridges when truck spacing was reduced from 40 to 30 ft.
- The number of trucks in a platoon has a minor impact. An exception to this is very long-span structures in poor condition.
- Bridge material (steel versus concrete) has a minor impact, while the bridge generation (i.e., the generation of the building code used to design the bridge) has a significant impact on bridge vulnerability, with older bridges designed with building codes prior to the introduction of LRFD methodology being more susceptible to negative impacts from truck automation and platooning.

### **Policy, Planning, and Investment Implications from the Pavement and Bridge Network Analyses**

The policy, planning, and investment implications of the pavement network analysis include:

- Under truck platooning, all key flexible pavement failure types are accelerated.
- Introducing dedicated hardened freight routes and/or truck lanes should be considered as options.

- The negative impact on TDC pavement service life is the greatest. Specific hardening actions that improve the cracking life of flexible pavements on key truck routes, including polymer modification, can improve the service life of pavements.
- Since the RSL for the JRCP is greatest, TxDOT may consider not using this type of construction on future autonomous/platoon truck highway lanes.
- Results show that all modes of failure are diminished with the introduction of HPMAs. Therefore, introducing dedicated truck lanes on key routes using PMA concrete is a viable option to minimize or fully negate the adverse effects of autonomous truck traffic on the Texas Highway Freight Network.

Importantly, the controlling factor in the reduction in pavement service life for all pavement types was the reduction in WW due to the introduction of truck automation. WW occurs naturally with human drivers due to the inability to steer continuously while maintaining an exact distance from the edge of the pavement. The computer control systems used by truck automation companies enable very precise control of the distance of the outer truck axles with respect to the edge of the pavement. Consequently, TxDOT may want to consider specifying how much WW should be required by truck automation and platoon truck companies in order to negate the negative effects of truck automation on the service life of Texas Highway Freight Network pavements.

Policy, planning, and investment implications of the bridge vulnerability analysis include:

- Some truck platoon configurations with close axle spacings—for example, three C5 trucks at 30-ft spacing—have a higher negative impact on bridges than others. TxDOT may want to consider specifying a minimum of 50-ft truck spacing in platoon truck configurations to minimize the impact on Texas bridges.
- Introducing guidelines for platoon truck weight distributions may be a way to reduce this impact.
- The results show that network-level analysis tools can be used effectively to assess future platooning configuration policies.

## **ECONOMIC IMPACT OF PLATOONING AND TRUCK AUTOMATION ON TEXAS HIGHWAYS**

The objective of the economic analysis in Task 6 was to identify the potential benefits and costs that truck platooning and automation may have on the overall economy of Texas, which was accomplished through the development and use of three scenarios that considered advancements in truck automation over the 30-year study period.

The first step in the analysis was a scenario development process that included identifying aspects of a long-haul truck trip between an origin and destination, with the initial and final segments of the trips occurring along arterial roadways and the main middle segment traversing



IH. In the base case, two separate trucks transporting goods travel independently over the entire corridor. The trip length requires an HOS-required 30-minute break and 10-hour rest periods. The 30-year analysis period is comprised of a short-term, midterm, and long-term time period, each with increasing levels of platooning and automation. Second, a case study corridor in the state was desired to capture actual values for economic evaluations. The project team investigated three corridors that are long enough to require the HOS breaks and also meet several other criteria, including high traffic volumes, a variety of pavement types, and a population of bridges. The project team decided on the 831-mi corridor between El Paso and Texarkana, which includes I-10, I-20, and I-30. After selecting a corridor, data were collected for each cost element necessary to conduct the benefit-cost analysis. These elements were grouped into four broad categories: vehicle configuration, vehicle operational environment, safety and labor, and infrastructure. Vehicle configuration included fuel costs, environmental costs, and automation technology costs. The operational environment included break costs and commodity costs. Safety and labor included driver wages, insurance costs, and accident costs. Infrastructure included bridge and pavement costs. Bridge and pavement costs were calculated by the research team, while the remaining elements were based on publicly available data. Using these data, the team conducted a benefit-cost analysis to determine the impacts of truck platooning on the study corridor. The analysis consisted of infrastructure costs to TxDOT, safety and environmental benefits to society, operational benefits to truck companies, and freight benefits to businesses. Thus, the results of the analysis compare the costs to TxDOT to the benefits to businesses, consumers, and society.

The analysis used a baseline scenario representing the status quo that was compared to a project scenario with increasing levels of truck platooning. The costs in the truck platooning scenario for each element were subtracted from the baseline scenario to generate the project costs and benefits.

The analysis was conducted twice, using a high and low truck growth rate, thereby giving a range of possible results. The analysis was conducted using a 3 percent discount rate, and all costs and benefits were discounted to 2020. The discounted net present value was \$1.9 billion in the low-growth scenario and \$2.4 billion in the high-growth scenario. The benefit-cost ratio was 6.62:1 in the low-growth scenario and 8.42:1 in the high-growth scenario, meaning that for every \$1 spent, there are \$8.42 of benefits. The project team then estimated the economic impacts using the input-output model IMPLAN. The operational cost savings calculated in the BCA represent the out-of-pocket savings to the trucking industry. These savings will be reinvested in the industry, distributed to shareholders and employees, and/or passed on to the customer and consumers.

The economic impact analysis shows the effects of these additional dollars on the Texas economy. The estimated economic impacts are categorized as direct, indirect, or induced. Direct impacts result from the initial change in expenditures to the truck transportation industry;

indirect impacts arise from the operations of the truck transportation industry (i.e., suppliers); and induced impacts are from household spending of direct and indirect wages. For this analysis, the direct jobs and income were reported as zero in the midterm and long-term scenarios to signal the reduction of drivers in the case study example. This feature reflects the loss of direct employment and does not calculate a direct employment gain based on the transportation savings. However, the increase in production dollars to the truck transportation industry will result in indirect and induced jobs. The economic analysis was performed for 2021, 2026, and 2036, which represent the first operational year of each scenario: near-term, midterm, and long-term. All monetary results are in 2020 dollars. Overall, the 2.4 percent growth rate results in an estimated \$1.4 million in economic output for the near-term scenario in 2021. This amount increases annually to \$36.7 million for the midterm scenario in 2026 and to \$154.1 million for the long-term scenario in 2036. The 3.5 percent growth rate results in an estimated \$38.8 million for the midterm scenario in 2026 and \$180.9 million for the long-term scenario in 2036.

## REFERENCES

1. *2017 Fatal Motor Vehicle Crashes: Overview*. National Highway Traffic Safety Administration: Washington, DC, October 2018.
2. *Highway Statistics 2017: Annual Vehicle Distance Traveled in Miles and Related Data* (Table VM-1). Federal Highway Administration, March 2019.
3. Fast Facts: U.S. Transportation Sector Greenhouse Gas Emissions 1990–2016. United States Environmental Protection Agency—Office of Transportation and Air Quality, July 2018.
4. *Annual Energy Outlook 2019 with projections to 2050*. U.S. Energy Information Administration, January 24, 2019.
5. Shladover, S., et al., *Cooperative Adaptive Cruise Control (CACC) for Partially Automated Truck Platooning: Final Report*. FHWA Exploratory Advanced Research Program and Caltrans, March 2018.
6. Bevely, D., et al., *Heavy Truck Cooperative Adaptive Cruise Control: Evaluation, Testing, and Stakeholder Engagement for Near Term Deployment: Phase Two Final Report*. Auburn University, 2017.
7. Lammert, M.P., A. Duran, J. Diez, K. Burton, and A. Nicholson, Effect of platooning on fuel consumption of class 8 vehicles over a range of speeds, following distances, and mass. *SAE International Journal of Commercial Vehicles*, 2014. 7(2014-01-2438): pp. 626–639.
8. Tsugawa, S., An overview on an automated truck platoon within the energy ITS project. *IFAC Proceedings Volumes*, 2013. 46(21): pp. 41–46.
9. Browand, F., J. McArthur, and C. Radovich, *Fuel Saving Achieved in the Field Test of Two Tandem Trucks*. University of California, Berkeley, 2004.
10. Dávila, A., *Safe Road Trans for the Environment (SARTRE) report on fuel consumption*. European Commission, Brussels, Belgium, 2013.
11. Bhoopalam, A.K., N. Agatz, and R. Zuidwijk, Planning of truck platoons: A literature review and directions for future research. *Transportation Research Part B: Methodological*, 2018. 107: pp. 212–228.
12. Sun, X. and Y. Yin, Behaviorally stable vehicle platooning for energy savings. *Transportation Research Part C: Emerging Technologies*, 2019. 99: pp. 37–52.
13. Fitzpatrick, D., G. Cordahi, L. O’Rourke, C. Ross, A. Kumar, and D. Bevely, *Challenges to CV and AV Applications in Truck Freight Operations*. Transportation Research Board, 2016.
14. Windover, P., R. Owens, and B. Roy, *Truck Platooning Policy Barriers Study*. New York State Department of Transportation: Albany, New York, January 2018.
15. Gordon, M., *Evaluation of Driver Assistive Truck Platooning on Traffic Flow*. Auburn University: Auburn, Alabama, 2015.
16. The Exploratory Advanced Research Program Fact Sheet: Increasing Highway Throughput. Federal Highway Administration.
17. Short, J. and D. Murray, *Identifying Autonomous Vehicle Technology Impacts on the Trucking Industry*. American Transportation Research Institute, 2016.
18. Viscelli, S., *Driverless? Autonomous Trucks and the Future of the American Trucker*. UC Berkeley Center for Labor Research and Education and Working Partnerships USA, 2018.

19. Roberts, J., R. Mihelic, and M. Roeth, *Trucking Efficiency Confidence Report: Two-Truck Platooning*. North American Council for Freight Efficiency, 2016.
20. Yankelevich, A., et al., *Preparing the Workforce for Automated Vehicles*. The American Center for Mobility, 2018.
21. *Preparing for the Future of Transportation: Automated Vehicles 3.0*. U.S. Department of Transportation, 2018.
22. *Traffic Safety Facts (2017 Data)—Large Trucks*. National Highway Traffic Safety Administration: Washington D.C., January 2019.
23. *Large Truck and Bus Crash Facts 2017*. Federal Motor Carrier Safety Administration—Analysis Division, May 2019.
24. Perry, E. and S. Ahn, *Developing a Regional Regulatory Approach to Truck Platooning in the MAASTO Region: A Literature Review of the History, Progress, and Benefits of Truck Platooning*. Mid-America Freight Coalition and the MAASTO Working Group, June 2018.
25. Greer, L., J.L. Fraser, D. Hicks, M. Mercer, and K. Thompson, *Intelligent Transportation Systems Benefits, Costs, And Lessons Learned: 2018 Update Report*. United States. Dept. of Transportation. ITS Joint Program Office, 2018.
26. Slowik, P. and B. Sharpe, *Automation in the Long Haul: Challenges and Opportunities of Autonomous Heavy-Duty Trucking in the United States*, March 2018.
27. Chottani, A., G. Hastings, J. Murnane, and F. Neuhaus, *Distraction or Disruption? Autonomous Trucks Gain Ground in US Logistics*. McKinsey & Company, December 2018.
28. *2018 Self-Driving Safety Report*. General Motors.
29. Khaleghi, B., A. Khamis, F.O. Karray, and S.N. Razavi, Multisensor data fusion: A review of the state-of-the-art. *Information Fusion*, 2013. 14(1): pp. 28–44.
30. Petit, J. and S.E. Shladover, Potential cyberattacks on automated vehicles. *IEEE Transactions on Intelligent Transportation Systems*, 2014. 16(2): pp. 546–556.
31. Fagnant, D.J. and K. Kockelman, Preparing a nation for autonomous vehicles: opportunities, barriers and policy recommendations. *Transportation Research Part A: Policy and Practice*, 2015. 77: pp. 167–181.
32. An Act Relating to Automated Motor Vehicles, in SB 2205. Texas 85th Legislature, September 2017.
33. Wagner, J., M. Moran, and M. Lukuc, *Regulatory and legal review of automated and connected truck platooning technology*. Texas A&M Transportation Institute, 2017.
34. Safely Ensuring Lives Future Deployment and Research in Vehicle Evolution Act or the SELF DRIVE Act, in HR 3388. 115th Congress, September 2017.
35. American Vision for Safer Transportation through Advancement of Revolutionary Technologies Act or the AV START Act, in S 1885. 115th Congress, November 2017.
36. Perlman, D., D. Bogard, A. Epstein, A. Santalucia, and A. Kim, *Review of the Federal Motor Carrier Safety Regulations for Automated Commercial Vehicles: Preliminary Assessment of Interpretation and Enforcement Challenges, Questions, and Gaps*. John A. Volpe National Transportation Systems Center (US), 2018.
37. Motor Vehicles: Provides relative to vehicle platooning, in HB 308: Louisiana, 2018.
38. An act relating to motor vehicles, in SB 125: Alabama, 2018.
39. An act relating to transportation, in HB 7061: Florida, 2016.

40. An act to regulate the testing of vehicles with autonomous technology; and for other purposes, in HB 1754: Arkansas, 2017.
41. Hubbard, S.M., Automated vehicle legislative issues. *Transportation Research Record*, 2018. 2672(7): pp. 1–13.
42. Dennis, E., W. Buller, I. Xique, Z. Fard, B. Hart, and G. Brannon, *Comparative Analysis of Sensor Types for Driver Assistance and Automated Driving Systems*. Transportation Research Board 2019 Annual Meeting, 2019.
43. Gain, B.C., The eyes of autonomy: new sensors pave the way for self-driving trucks. *Transport Topics*, 2018.
44. Yoshino, H., R. Yamaguchi, and M. Mikami, *5G Overall System Trial—An application of 5G Ultra-Low-Latency Communication to Truck Platooning*. The International Telecommunication Union Association of Japan, 2018.
45. Wiltz, C., TuSimple Takes a LiDAR-Free Approach to Autonomous Trucks, in *DesignNews*, 2018.
46. Tiwari, K., Why Our Company’s Trucks Won’t Carry Lidar, in *IEEE Spectrum*, 2018.
47. Gain, B., Solid-State LiDAR Emerges as the Flavor of Choice for Self-Driving Cars, in *WonderHowTo-Driverless*, 2017.
48. Molinaro, A. and C. Campolo, 5G for V2X Communications. 5G Italy, 2019.
49. Uusitalo, M., Wireless for Verticals. NOKIA Bell Labs, 2017.
50. Gungor, O.E., R. She, I.L. Al-Qadi, and Y. Ouyang, Optimization of Lateral Position of Autonomous Trucks (OPLAT), in Transportation Research Board 2019 Annual Meeting, 2019.
51. Chen, D., S. Ahn, M. Chitturi, and D. Noyce, Truck platooning on uphill grades under cooperative adaptive cruise control (CACC). *Transportation Research Part C: Emerging Technologies*, 2018. 94: pp. 50–66.
52. <https://www.nhtsa.gov/technology-innovation/automated-vehicles-safety>. Automated Vehicles for Safety.
53. Texas Department of Transportation. Unified Transportation Program 2019.
54. Texas Department of Transportation. *2019–2022 Statewide Transportation Improvement Program*.
55. Texas Department of Transportation. *Texas Transportation Plan 2040*.
56. ARA, Inc. *Guide for Mechanistic-Empirical Design of New and Rehabilitated Pavement Structures*. Final Report, NCHRP Project 1-37A. Transportation Research Board, National Research Council, Washington, DC, 2004.
57. Lytton, R.L., F.L. Tsai, S.I. Lee, R. Luo, S. Hu, and F. Zhou. *Models for Predicting Reflection Cracking of Hot Mix Asphalt Overlays*. NCHRP Report 669. Transportation Research Board, 2010, Washington, DC.
58. Adeli, H., Neural Networks in Civil Engineering: 1989–2000. *Computer-Aided Civil and Infrastructure Engineering*, Vol. 16, 2001, pp. 126–142.
59. Montebello, D. and Schroeder, J., *Cost of Pavement Marking Materials*, Minnesota Department of Transportation Report # 2000-11, March 2000.
60. Pike, A. and Bommanayakanahalli B., Development of a Pavement Marking Life Cycle Cost Tool, *Transportation Research Record: Journal of the Transportation Research Board* 2018. 2672, 149–157.
61. Carlson, P., E. Park, and C. Andersen. Benefits of Pavement Markings. *Transportation Research Record: Journal of the Transportation Research Board*, 2009. 2107: 59–68.

62. Miller, T., Benefit Cost Analysis of Lane Marking. *Transportation Research Record*, 1992.
63. Cottrel and Hansen, *Determining the Effectiveness of Pavement Marking Materials* VTRC 01-R9.
64. <https://www.swarco.com/stories/road-markings-and-autonomous-driving-systems>
65. <https://www.itsrm.org/national-committee-on-uniform-traffic-control-devices-connected-automated-vehicle-cav-task-force-tcd-suggestions-for-automated-driving-systems-ads-feedback-from-automotive-oems/>
66. Han, R., Jin, X., and Glover, C.J. Modeling pavement temperature for use in binder oxidation models and pavement performance prediction. *Journal of Materials in Civil Engineering*, 2011, 23 (4), 351–359.
67. Saha, S., Gu, F., Luo, X. and Lytton, R.L., 2017. Prediction of Soil-Water Characteristic Curve Using Artificial Neural Network Approach. In *PanAm Unsaturated Soils 2017* (pp. 124–134).
68. Saha, S., Gu, F., Luo, X. and Lytton, R.L., 2018. Use of an artificial neural network approach for the prediction of resilient modulus for unbound granular material. *Transportation Research Record*, 2672(52), pp. 23–33.
69. Zhang, J., Peng, J., Zheng, J., Dai, L. and Yao, Y., 2019. Prediction of resilient modulus of compacted cohesive soils in South China. *International Journal of Geomechanics*, 19(7), p.04019068.
70. Coleri, E., Guler, M., Gungor, A.G. and Harvey, J.T., 2010. Prediction of subgrade resilient modulus using genetic algorithm and curve-shifting methodology: alternative to nonlinear constitutive models. *Transportation Research Record*, 2170(1), pp. 64–73.
71. Lytton, R. L. Foundations and pavements on unsaturated soils. Keynote Address, Proc. 1st Int. conf. on unsaturated soils, Paris, France, 3, 1201–1220, 1995.
72. Saha, S., Hariharan, N., Gu, F., Luo, X., Little, D.N. and Lytton, R.L. Development of a mechanistic-empirical model to predict equilibrium suction for subgrade soil. *Journal of Hydrology*, 2019, 575, pp. 221–233.
73. Saha, S., Gu, F., Luo, X. and Lytton, R.L. Prediction of soil-water Characteristic Curve for unbound material using Fredlund–Xing Equation-based ANN approach. *Journal of Materials in Civil Engineering*, 2018, 30(5), p.06018002.
74. Ceylan, R., Y. Ozbay, B. Karlik. A novel approach for classification of ECG arrhythmias: Type-2 fuzzy clustering neural network. *Expert Systems with Applications*, 36 (2009), pp. 6721–6726.
75. Zhang, D., Birgisson, B., Luo, X. and Onifade, I., 2019. A new long-term aging model for asphalt pavements using morphology-kinetics based approach. *Construction and Building Materials*, 229, p.117032.
76. Dinegdae, Y.H., Onifade, I., Jelagin, D. and Birgisson, B., 2015. Mechanics-based top-down fatigue cracking initiation prediction framework for asphalt pavements. *Road Materials and Pavement Design*, 16(4), pp. 907–927.
77. Zhang, Z., Roque, R., Birgisson, B., & Sangpetngam, B., 2001. Identification and verification of a suitable crack growth law. *Journal of the Association of Asphalt Paving Technologists*, 70, 206–241.
78. Roque, R., Birgisson, B., Sangpetngam, B., & Zhang, Z., 2002. Hot mix asphalt fracture mechanics: A fundamental crack growth Law for asphalt mixtures. *Journal of the Association of Asphalt Paving Technologists*, 71, 816–827.

79. Das, P.K., Birgisson, B., Jelagin, D. and Kringos, N., 2015. Investigation of the asphalt mixture morphology influence on its ageing susceptibility. *Materials and Structures*, 48(4), pp. 987–1000.
80. Onifade, I., Jelagin, D., Birgisson, B., Kringos, N., 2015. Towards Asphalt Mixture Morphology Evaluation with the Virtual Specimen Approach. *Road Mater. Pavement Des.* Vol. 17. <https://doi.org/10.1080/14680629.2015.1098561>
81. Ling, M., Luo, X., Hu, S., Gu, F. and Lytton, R.L. Numerical modeling and artificial neural network for predicting J-integral of top-down cracking in asphalt pavement. *Transportation Research Record*, 2017, 2631(1), pp. 83–95.
82. Darter, M.I. and Barenberg, E. J., *Zero-Maintenance Pavement: Results of Field Studies on the Performance Requirements and Capabilities of Conventional Pavement Systems*, Federal Highway Administration, Interim Report, April 1976.
83. Joshaghani, Ali, and Dan G. Zollinger (2019), “Assessment of Concrete Pavement Set Gradient Based on Analysis of Slab Behavior and Field Test Data” *Transportation Research Record: Journal of the Transportation Research Board*, 2673(11), 512–523.
84. DeVault, A. and T.E. Beitelman, *Two-Truck Platooning, in Load Effects of Two-Truck Platoons on Interstate and Turnpike Bridges in Florida*. 2017.
85. FHWA, National Bridge Inventory (NBI). 2017: Washington, DC.
86. Kamranian, Z., *Load Evaluation of the Hay River Bridge Under Different Platoons of Connected Trucks*, Schulich School of Engineering. 2019, University of Calgary
87. Yarnold, M.T. and J.S. Weidner, Truck Platoon Impacts on Steel Girder Bridges. *Journal of Bridge Engineering*, 2019. 24(7).
88. Tohme, R., *The Effects of Truck Platooning on Steel Bridge Load Ratings*, in Zachry Department of Civil Engineering. 2019, Texas A&M University.
89. Tsugawa, S., S. Jeschke, and S.E. Shladover, A Review of Truck Platooning Projects for Energy Savings. *IEEE Transactions on Intelligent Vehicles*, 2016. 1(1): pp. 68–77.
90. McAuliffe, B., M. Lammert, X.-Y. Lu, S. Shladover, M.-D. Surcel, and A. Kailas, Influences on Energy Savings of Heavy Trucks Using Cooperative Adaptive Cruise Control. 2018: SAE Technical Paper 2018-01-1181.
91. Peloton. Website. 2019; Available from <https://peloton-tech.com/how-it-works/>.
92. ALDOT, *Structural Design Manual*. 2017.
93. DelDOT, *Bridge Design Manual*. 2017.
94. FDOT, *Florida Department of Transportation Bridge Load Rating Manual*. 2015.
95. Sivakumar, B., F. Moses, G. Fu, and M. Ghosn, *NCHRP Report 575: Legal Truck Loads and AASHTO Legal Loads for Posting*. 2007, Transportation Research Board: Washington, DC.
96. AASHTO, *The Manual for Bridge Evaluation*, 3rd Edition. 2018: Washington, DC.
97. Hueste, M.B.D., M.S.U. Adil, M. Adnan, and P.B. Keating, *Impact of LRF D Specification on Design of Texas Bridges Volume 1: Parametric Study*. 2006: FHWA/TX-07/0-4751-1 Vol. 1.
98. AASHTO, *LRF D Bridge Construction Specifications*, 4th edition. 2017: Washington, DC.
99. AASHTO, *Standard Specification for Highway Bridges*, 17th edition. 2002: Washington, DC.
100. Kulicki, J.M., Evolution of the AASHTO Bridge Design Specifications, Lecture presented in University at Buffalo, New York. 2018.

101. AASHTO, *The Manual for Bridge Evaluation*, 2nd Edition with 2011, 2013, 2014, 2015, and 2016 Interim Revisions. 2010: Washington, DC.
102. Hansell, W.C. and I.M. Viest, Load Factor Design for Steel Highway Bridges. *Engineering Journal*, AISC, 1971. 8: pp. 113–123.
103. Mertz, D., *Load Rating by Load and Resistance Factor Evaluation Method*. 2005: NCHRP Project 20-07, Task 122.
104. Mlynarski, M., W.G. Wassef, and A.S. Nowak, *NCHRP Report 700: A Comparison of AASHTO Bridge Load Rating Methods*. 2011, Transportation Research Board: Washington, DC.
105. Barker, M.G., D.M. Koenig, and L.M. Magruder, *Load Rating Steel and Concrete Girder Bridges in Missouri*. 1994: MCHRP Report 91-1.
106. Schelling, D.R. and C.C. Fu, Comparison of Bridge Rating Methods. *Journal of Structural Engineering*, 1984. 110(7): pp. 1447–1466.
107. Schneider, C. M., Moreira, A. A., Andrade, J. S., Havlin, S., & Herrmann, H. J. (2011). Mitigation of malicious attacks on networks. *Proceedings of the National Academy of Sciences*, 108(10), 3838–3841.
108. Texas Department of Transportation (TxDOT). *Texas Freight Mobility Plan 2018*. Austin, TX. Available at <https://www.dot.state.tx.us/move-texas-freight/studies/freight-plan.htm>.
109. Bracy, J., Bao, K., & Mundy, R. (2018). *Paving the way for autonomous and connected vehicle technologies in the motor carrier industry*. Institute for Transportation. Iowa State University. Available at <https://rosap.nsl.bts.gov/view/dot/36103>.
110. Bevely, D., Murray, C., Lim, A., Turochy, R., Sesek, R., Smith, S., ... Kahn, B. (2017). *Heavy truck cooperative adaptive cruise control: evaluation, testing, and stakeholder engagement for near term deployment: phase two final report*.
111. Peloton. Preventing Crashes, Saving Fuel, Connecting Trucks. Available at <https://www.legis.state.tx.us/tlodocs/84R/handouts/C4702016120709001/3499dbc2-b007-40d9-b1b1-c8e0eb3989f1.PDF>.
112. EIA. Weekly Retail Gasoline and Diesel Prices. Available at [https://www.eia.gov/dnav/pet/pet\\_pri\\_gnd\\_dcus\\_r30\\_a.htm](https://www.eia.gov/dnav/pet/pet_pri_gnd_dcus_r30_a.htm)
113. U.S. Department of Transportation. (January 2020). Benefit-Cost Analysis Guidance for Discretionary Grant Programs. Available at [https://www.transportation.gov/sites/dot.gov/files/2020-01/benefit-cost-analysis-guidance-2020\\_0.pdf](https://www.transportation.gov/sites/dot.gov/files/2020-01/benefit-cost-analysis-guidance-2020_0.pdf)
114. Slowik, P., & Sharpe, B. (2018). *Automation in the long haul: Challenges and opportunities of autonomous heavy-duty trucking in the United States*. The International Council on Clean Transportation.
115. Bracy, J., Bao, K., & Mundy, R. A. (2018). *Paving the way for autonomous and connected vehicle technologies in the motor carrier industry*. Institute for Transportation Iowa State University.
116. TxDOT Roadway Inventory. Available at <https://gis-txdot.opendata.arcgis.com/datasets/txdot-roadway-inventory>.
117. Fitzroy, Stephen, et al., New Methods for Assessing the Costs of Delay and Reliability on Major Highway Corridors: A Commodity-Focused/Industry Sector Approach for Addressing Freight Planning in MAP-21. ITED Conference 2014. <https://www.edrgroup.com/pdf/Fitzroy-ITED-2014.pdf>



## APPENDIX A. ONLINE SURVEY QUESTIONNAIRE

### Common Questions for All Respondents

1. Please select whether you are a (select all that apply):
  - Company driver
  - Fleet management
  - Trucking association
  - Federal administrations
  - State DOT
  - Local MPO
  - Automated and connected vehicle manufacturer
  - Platooning system suppliers
  - Other:

#### *1-1. You have selected driver/fleet management*

2. Which sector of the trucking industry do you primarily operate in/manage?
  - Truckload
  - Less-than-truckload
  - Flatbed
  - Tanker
  - Express/Parcel service
  - Drayage
  - Other
3. What is your typical length of haul?
  - Local (less than 100 miles)
  - Regional-short/line haul (100-499 miles per trip)
  - Inter-regional (500-599 miles per trip)
  - Long-haul (1000 or more miles per trip)
4. What types of roadway do you use most frequently or typically drive?
  - Urban interstate and similar class highways, more than three lanes in the same direction
  - Rural interstate and similar class highways, two lanes in the same direction
  - Undivided rural highways
  - Urban and suburban roads and streets

**1-2. You have selected other than driver/fleet management**

5. Please select your role in relation to truck platooning and automated trucks (select all that apply).
- Planning
  - Policy
  - Infrastructure
  - Other:

**Stakeholder Type 1. Trucking Fleet Personnel, Owner-Operators, and Industry Associations**

1. How familiar are you with the use of truck adaptive cruise control?
- | 1                   | 2                 | 3                   | 4             | 5                  |
|---------------------|-------------------|---------------------|---------------|--------------------|
| Not at all Familiar | Slightly Familiar | Moderately Familiar | Very Familiar | Extremely Familiar |
2. Considering an estimated fuel savings/time savings/less driving effort, what is the maximum amount per truck you would be willing to pay to purchase the equipment required to allow platooning and automated truck operations (one-time cost per truck)?
- Less than \$1,000
  - \$5,000 - \$10,000
  - \$1,000 – \$5,000
  - More than \$10,000
3. When operating in the vicinity of other platoon-capable trucks, with whom should you be able to platoon? (select all that apply)
- Other owner-operators with similar/standardized equipment
  - Any large fleet
  - Specific fleets with whom you have already agreed to partner
  - Your own fleet trucks
  - Any certified platoon-capable trucks
4. What should be the driver requirement(s) after initial training in platoon operations?
- No additional requirements after initial/one-time post-training test/qualification
  - Periodic re-certification
  - Additional endorsement on their Commercial Driver’s License (CDL)
  - No certification of training should be necessary

5. How likely do you think truck platooning will have a positive impact on driver retention?
- |                      |                    |                    |             |                     |
|----------------------|--------------------|--------------------|-------------|---------------------|
| 1                    | 2                  | 3                  | 4           | 5                   |
| Not at all<br>Likely | Not Very<br>Likely | Somewhat<br>Likely | Very Likely | Extremely<br>Likely |
6. How likely do you think drivers are to want to use an automated truck system?
- |                      |                    |                    |             |                     |
|----------------------|--------------------|--------------------|-------------|---------------------|
| 1                    | 2                  | 3                  | 4           | 5                   |
| Not at all<br>Likely | Not Very<br>Likely | Somewhat<br>Likely | Very Likely | Extremely<br>Likely |
7. How likely do you think drivers are to want to use truck platooning?
- |                      |                    |                    |             |                     |
|----------------------|--------------------|--------------------|-------------|---------------------|
| 1                    | 2                  | 3                  | 4           | 5                   |
| Not at all<br>Likely | Not Very<br>Likely | Somewhat<br>Likely | Very Likely | Extremely<br>Likely |
8. Assess the projected market demand for automated trucks and truck platooning technology in the near term (2020-2025).
- |                    |            |         |             |                     |
|--------------------|------------|---------|-------------|---------------------|
| 1                  | 2          | 3       | 4           | 5                   |
| Very Low<br>Demand | Low Demand | Neutral | High Demand | Very High<br>Demand |
9. Assess the projected market demand for automated trucks and truck platooning technology in the medium term (2026-2035).
- |                    |            |         |             |                     |
|--------------------|------------|---------|-------------|---------------------|
| 1                  | 2          | 3       | 4           | 5                   |
| Very Low<br>Demand | Low Demand | Neutral | High Demand | Very High<br>Demand |
10. Assess the projected market demand for automated trucks and truck platooning technology in the longer term (beyond 2035).
- |                    |            |         |             |                     |
|--------------------|------------|---------|-------------|---------------------|
| 1                  | 2          | 3       | 4           | 5                   |
| Very Low<br>Demand | Low Demand | Neutral | High Demand | Very High<br>Demand |
11. What are the most important challenges facing the transportation community as it relates to the introduction of automated truck operations? (select all that apply)
- Increasing fuel cost
  - Changes in the trucking job environment
  - Public acceptance of automated trucks
  - Policy & Regulation
  - Infrastructure preparedness for automation
  - Platooning equipment cost

- Liability/Insurance
  - Reliability of platooning equipment
12. What are the most important challenges facing the transportation community as it relates to the introduction of truck platooning? (select all that apply)
- Increasing fuel cost
  - Changes in the trucking job environment
  - Public acceptance of automated trucks
  - Policy & Regulation
  - Infrastructure preparedness for automation
  - Platooning equipment cost
  - Liability/Insurance
  - Reliability of platooning equipment
13. On which types of road(s) should platooning be allowed? (select all that apply)
- Urban interstate and similar class highways, more than three lanes in the same direction
  - Rural interstate and similar class highways, two lanes in the same direction
  - Undivided rural highways
  - Urban and suburban roads and streets
  - Dedicated truck lane/roadway
14. What types of vehicles (semi-truck tractors, box trucks, etc.) should be allowed to engage in platooning? (select all that apply)
- Single unit [Local delivery truck or box truck]
  - Single trailer, four or less axles [Less than truckload (LTL)]
  - 5-Axle tractor semitrailer [typical 18-wheeler]
  - Multi-trailer
  - Other
15. What are the complications/risks areas that you envision during the transition phase (i.e., the mixed environment of conventional trucks, automated trucks, and platooned trucks)?
- Operations around highway construction zones
  - Use of existing infrastructure design
  - Public acceptance of new technologies
  - Policy changes/implementation
  - Insurance/liability changes
  - Other:

16. What level of involvement is expected in facilitating automated and platooned trucks from infrastructure owner-operator?
- No/very limited involvement
  - Allowing automated and platooned trucks
  - Sending notification to automated and platooned trucks
  - Approving requests for automated/platooned operation
  - Actively involved in setting up automated and platooned trucks
17. How should highway users be notified of truck platooning and automated truck corridors?
- Static signage
  - Dynamic signal display
  - Other
18. Select weather/visibility conditions when truck platooning should not be permitted (select all that apply).
- Wet/Rainy
  - Low light
  - Snowy/Icy
  - Other
19. Select traffic volume condition(s) when truck platooning would be permitted?
- |  | 1                            | 2                                  | 3                       | 4   | 5                             |
|--|------------------------------|------------------------------------|-------------------------|---|-------------------------------|
|  | Low Volume<br>with No Delays | Low Volume<br>with Minor<br>Delays | Volume Near<br>Capacity | Volume at or<br>Slightly Over<br>Capacity | Volume<br>Exceeds<br>Capacity |
20. What infrastructure changes are most needed in automated and platooned truck environment?
- Changes in interchange/ramp spacing
  - Signage improvements
  - Improved pavement markings
  - Other
21. Should truck platooning be disengaged in the following area(s)?
- Incident/Accident zones
  - Automated toll gates
  - Work zones
  - Entrance/Exit ramps

- Upon entering roadside safety rest areas
  - Other:
22. Should there be any restriction(s) in the type of cargo that platooning trucks can transport?
- Project cargo (e.g., windmill blades, bridge beams, oversized equipment, etc.)
  - Standard/Intermodal containers
  - Oversize/overweight trucks
  - Hazardous Materials
  - Other:

**Stakeholder Type 2. OEMs, Start-Ups, Tier 1,2 Suppliers, System Integrators, and Other Implementers**

1. When operating in the vicinity of other platoon-capable trucks, with whom should you be able to platoon? (select all that apply)
- Other owner-operators with similar/standardized equipment
  - Any large fleet
  - Specific fleets with whom you have already agreed to partner
  - Your own fleet trucks
  - Any certified platoon-capable trucks

2. How likely do you think drivers are to want to use an automated truck system?
- |                      |                    |                    |             |                     |
|----------------------|--------------------|--------------------|-------------|---------------------|
| 1                    | 2                  | 3                  | 4           | 5                   |
| Not at all<br>Likely | Not Very<br>Likely | Somewhat<br>Likely | Very Likely | Extremely<br>Likely |

3. How likely do you think drivers are to want to use truck platooning?
- |                      |                    |                    |             |                     |
|----------------------|--------------------|--------------------|-------------|---------------------|
| 1                    | 2                  | 3                  | 4           | 5                   |
| Not at all<br>Likely | Not Very<br>Likely | Somewhat<br>Likely | Very Likely | Extremely<br>Likely |

4. Assess the projected market demand for automated trucks and truck platooning technology in the near term (2020-2025).
- |                    |            |         |             |                     |
|--------------------|------------|---------|-------------|---------------------|
| 1                  | 2          | 3       | 4           | 5                   |
| Very Low<br>Demand | Low Demand | Neutral | High Demand | Very High<br>Demand |

5. Assess the projected market demand for automated trucks and truck platooning technology in the medium term (2026-2035).

1	2	3	4	5
Very Low Demand	Low Demand	Neutral	High Demand	Very High Demand

6. Assess the projected market demand for automated trucks and truck platooning technology in the longer term (beyond 2035).

1	2	3	4	5
Very Low Demand	Low Demand	Neutral	High Demand	Very High Demand

7. What are the most important challenges facing the transportation community as it relates to the introduction of automated truck operations? (select all that apply)

- Increasing fuel cost
- Changes in the trucking job environment
- Public acceptance of automated trucks
- Policy & Regulation
- Infrastructure preparedness for automation
- Platooning equipment cost
- Liability/Insurance
- Reliability of platooning equipment

8. What are the most important challenges facing the transportation community as it relates to the introduction of truck platooning? (select all that apply)

- Increasing fuel cost
- Changes in the trucking job environment
- Public acceptance of automated trucks
- Policy & Regulation
- Infrastructure preparedness for automation
- Platooning equipment cost
- Liability/Insurance
- Reliability of platooning equipment

9. On which types of road(s) should platooning be allowed? (select all that apply)
- Urban interstate and similar class highways, more than three lanes in the same direction
  - Rural interstate and similar class highways, two lanes in the same direction
  - Undivided rural highways
  - Urban and suburban roads and streets
  - Dedicated truck lane/roadway
10. What types of vehicles (semi-truck tractors, box trucks, etc.) should be allowed to engage in platooning? (select all that apply)
- Single unit [Local delivery truck or box truck]
  - Single trailer, four or less axles [Less than truckload (LTL)]
  - 5-Axle tractor semitrailer [typical 18-wheeler]
  - Multi-trailer
  - Other
11. Under what time frame do you expect to see Level 2 automation where the vehicle can perform sustained control of both steering and acceleration/deceleration?
- Near Term (2020-2025)
  - Medium Term (2026-2035)
  - Longer Term (Beyond 2035)
12. Under what time frame do you expect to see Level 3 automation where all driving tasks can be controlled by the system in some situations?
- Near Term (2020-2025)
  - Medium Term (2026-2035)
  - Longer Term (Beyond 2035)
13. Under what time frame do you expect to see Level 4 automation where all driving tasks can be handled by the system without human intervention but in limited environments?
- Near Term (2020-2025)
  - Medium Term (2026-2035)
  - Longer Term (Beyond 2035)



14. Under what time frame do you expect to see Level 5 automation where an automated system can handle all roadway conditions and environments?
- Near Term (2020-2025)
  - Medium Term (2026-2035)
  - Longer Term (Beyond 2035)
15. What are the complications/risks areas that you envision during the transition phase (i.e., the mixed environment of conventional trucks, automated trucks, and platooned trucks)?
- Operations around highway construction zones
  - Use of existing infrastructure design
  - Public acceptance of new technologies
  - Policy changes/implementation
  - Insurance/liability changes
  - Other:
16. What level of involvement is expected in facilitating automated and platooned trucks from infrastructure owner-operator?
- No/very limited involvement
  - Allowing automated and platooned trucks
  - Sending notification to automated and platooned trucks
  - Approving requests for automated/platooned operation
  - Actively involved in setting up automated and platooned trucks
17. What are the biggest challenges facing large-scale automated trucks/truck platooning deployment (select all that apply)?
- Institutional/Policy/Legislation
  - Cybersecurity/Safety
  - Infrastructure Design
  - Public perception
  - Others:
18. What do you anticipate will be the impact of implementing automated trucks and truck platooning technologies on traditional infrastructure funding?
- |               |          |          |          |               |
|---------------|----------|----------|----------|---------------|
| 1             | 2        | 3        | 4        | 5             |
| Very Negative | Negative | Moderate | Positive | Very Positive |

19. How should truck platooning and automated truck corridors/segments be communicated to highway users?
- Static signage
  - Dynamic signal display
  - Other:
20. Select weather/visibility conditions when truck platooning should not be permitted (select all that apply).
- Wet/Rainy
  - Low light
  - Snowy/Icy
  - Other
21. Select traffic volume condition(s) when truck platooning would be permitted?
- | 1                            | 2                                  | 3                       | 4   | 5                             |
|------------------------------|------------------------------------|-------------------------|---|-------------------------------|
| Low Volume<br>with No Delays | Low Volume<br>with Minor<br>Delays | Volume Near<br>Capacity | Volume at or<br>Slightly Over<br>Capacity | Volume<br>Exceeds<br>Capacity |
22. What infrastructure changes are most needed in automated and platooned truck environment?
- Changes in Interchange/Ramp spacing
  - Signage improvements
  - Improved Pavement markings
  - Other
23. Should truck platooning be disengaged in the following area(s)?
- Incident/Accident zones
  - Automated toll gates
  - Work zones
  - Entrance/Exit ramps
  - Upon entering roadside safety rest areas
  - Other:

24. Should there be any restriction(s) in the type of cargo that platooning trucks can transport?
- Project cargo (e.g. windmill blades, bridge beams, oversized equipment, etc.)
  - Standard/Intermodal containers
  - Oversize/overweight trucks
  - Hazardous Materials
  - Other:
25. How many trucks in a single platoon do you foresee?
- 2
  - 3
  - 4
  - 5 or more
26. What do you foresee as the control for truck platooning?
- Time gap
  - Distance gap
  - Other
27. What should be the minimum distance between the trucks in a platoon?
- 20 ft or less
  - 30 ft
  - 40 ft
  - 50 ft
  - 60 ft
  - Greater than 60 ft
28. What should be the minimum time gap between the trucks in a platoon?
- 0.6 sec
  - 0.9 sec
  - 1.2 sec
  - 1.5 sec
  - 1.8 sec
  - Other
29. What should be the maximum allowable speeds for truck platooning?
- 50 mph
  - 55 mph
  - 65 mph

- 70 mph
  - Greater than 70 mph
30. What is the anticipated maximum weight per truck within a platoon?
- 65,000 lb or less
  - 80,000 lb
  - 95,000 lb
  - 110,000 lb
  - Other
31. How should trucks in a platoon broadcast active engagement to law enforcement and other vehicles?
- Flashing light
  - Sign on a truck
  - Decals
  - Other:
32. How should the drivers in the platooning vehicles communicate with each other?
- Radio
  - Through the automated truck system/device
  - Other:
33. Who should initiate the formation of a truck platoon?
- Driver(s)
  - Company Operation Center
  - Infrastructure Owner Operator Provided Center
  - Other:
34. Do you anticipate truck platoons taking place in more than one lane at a time?
- Yes
  - No
35. When platooned trucks are not in exclusive truck lanes, should a platoon be allowed to change lanes?
- Yes
  - No

**Stakeholder Type 3. Legislative, Government, Texas Cities / MPOs, and State DOT personnel**

1. Assess the projected market demand for automated trucks and truck platooning technology in the near term (2020-2025).

1	2	3	4	5
Very Low Demand	Low Demand	Neutral	High Demand	Very High Demand

2. Assess the projected market demand for automated trucks and truck platooning technology in the medium term (2026-2035).

1	2	3	4	5
Very Low Demand	Low Demand	Neutral	High Demand	Very High Demand

3. Assess the projected market demand for automated trucks and truck platooning technology in the longer term (beyond 2035).

1	2	3	4	5
Very Low Demand	Low Demand	Neutral	High Demand	Very High Demand

4. What are the most significant planning factors that are considered to be important for future DOT planning for platooning and automated trucks? (select all that apply)

- Infrastructure Design
- Safety/Cybersecurity
- Operational Efficiency
- Cost
- Fuel Savings

5. What are the most important challenges facing the transportation community as it relates to the introduction of automated truck operations? (select all that apply)

- Increasing fuel cost
- Changes in the trucking job environment
- Public acceptance of automated trucks
- Policy & Regulation
- Infrastructure preparedness for automation
- Platooning equipment cost
- Liability/Insurance
- Reliability of platooning equipment

6. What are the most important challenges facing the transportation community as it relates to the introduction of truck platooning? (select all that apply)

- Increasing fuel cost
  - Changes in the trucking job environment
  - Public acceptance of automated trucks
  - Policy & Regulation
  - Infrastructure preparedness for automation
  - Platooning equipment cost
  - Liability/Insurance
  - Reliability of platooning equipment
7. On which types of road(s) should platooning be allowed? (select all that apply)
- Urban interstate and similar class highways, more than three lanes in the same direction
  - Rural interstate and similar class highways, two lanes in the same direction
  - Undivided rural highways
  - Urban and suburban roads and streets
  - Dedicated truck lane/roadway
8. What types of vehicles (semi-truck tractors, box trucks, etc.) should be allowed to engage in platooning? (select all that apply)
- Single unit [Local delivery truck or box truck]
  - Single trailer, four or less axles [Less than truckload (LTL)]
  - 5-Axle tractor semitrailer [typical 18-wheeler]
  - Multi-trailer
  - Other
9. What are the preferred funding source(s) for infrastructure improvements/accommodations to support automation/platooning of trucks?
- Federal—Transportation funds
  - Federal—Economic development or other non-transportation funds
  - State
  - Local
  - Private
10. Under what time frame do you expect to see Level 2 automation where the vehicle can perform sustained control of both steering and acceleration/deceleration?
- Near Term (2020-2025)
  - Medium Term (2026-2035)
  - Longer Term (Beyond 2035)

11. Under what time frame do you expect to see Level 3 automation where all driving tasks can be controlled by the system in some situations?
  - Near Term (2020-2025)
  - Medium Term (2026-2035)
  - Longer Term (Beyond 2035)
  
12. Under what time frame do you expect to see Level 4 automation where all driving tasks can be handled by the system without human intervention but in limited environments?
  - Near Term (2020-2025)
  - Medium Term (2026-2035)
  - Longer Term (Beyond 2035)
  
13. Under what time frame do you expect to see Level 5 automation where an automated system can handle all roadway conditions and environments?
  - Near Term (2020-2025)
  - Medium Term (2026-2035)
  - Longer Term (Beyond 2035)
  
14. What planning strategies will help make confident decisions despite rapid technological evolution?
  
15. What should public agencies be doing to facilitate partnerships and collaboration among various stakeholders interested in automated vehicle/truck platooning adoption?
  
16. What are the complications/risks areas that you envision during the transition phase (i.e., the mixed environment of conventional trucks, automated trucks, and platooned trucks)?
  - Operations around highway construction zones
  - Use of existing infrastructure design
  - Public acceptance of new technologies
  - Policy changes/implementation
  - Insurance/liability changes
  - Other:
  
17. What are the major policy issues associated with truck automation and platooned trucks?
  - Federal regulations
  - Public education campaigns
  - Demonstration projects in real-world settings
  - Infrastructure design / upgrade
  - Others:

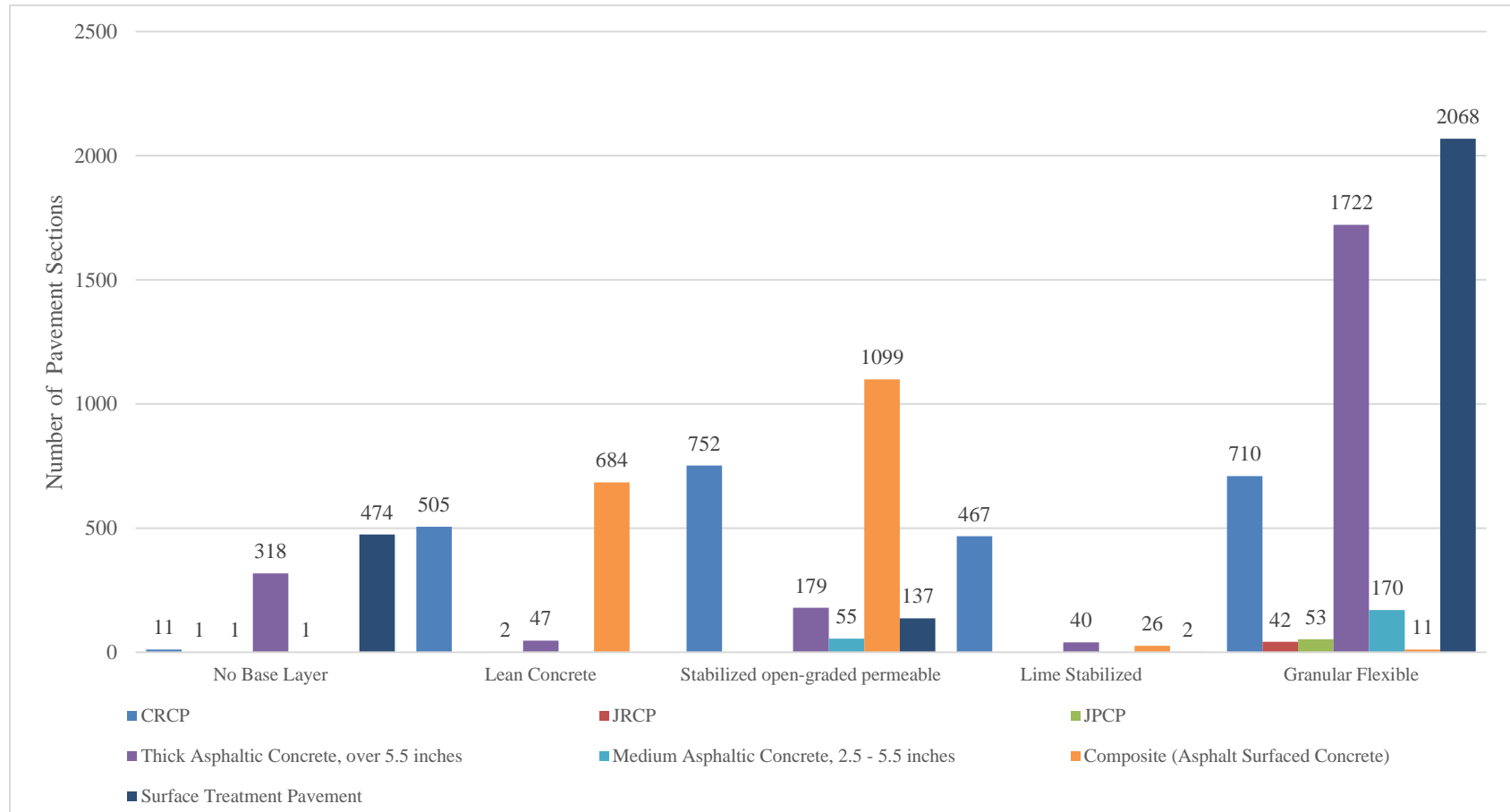
18. What is your opinion on the current Texas state programs to achieve higher levels of automation operations, maintenance, or investment?
- |               |                      |          |               |                                 |
|---------------|----------------------|----------|---------------|---------------------------------|
| 1             | 2                    | 3        | 4             | 5                               |
| Very Negative | Somewhat<br>Negative | Positive | Very Positive | No<br>opinion/Not<br>applicable |
19. What do you anticipate will be the impact of implementing automated trucks and truck platooning technologies on traditional infrastructure funding?
- |               |          |          |          |               |
|---------------|----------|----------|----------|---------------|
| 1             | 2        | 3        | 4        | 5             |
| Very Negative | Negative | Moderate | Positive | Very Positive |
20. What public agency actions do you recommend to design effective policies and accelerate the adoption of automated trucks and truck platooning?
- Understanding operational safety levels
  - Adapting Infrastructure design standards
  - Increasing Driver training
  - Increased Certification of equipment
  - Interoperability between States
  - Public sector taking on some of the liability costs/issues
  - Better Delineation of rules and responsibilities
  - Other
21. How should truck platooning and automated truck corridors/segments be communicated to highway users?
- Static signage
  - Dynamic signal display
  - Other
22. Select weather/visibility conditions when truck platooning should not be permitted (select all that apply).
- Wet/Rainy
  - Low light
  - Snowy/Icy
  - Other



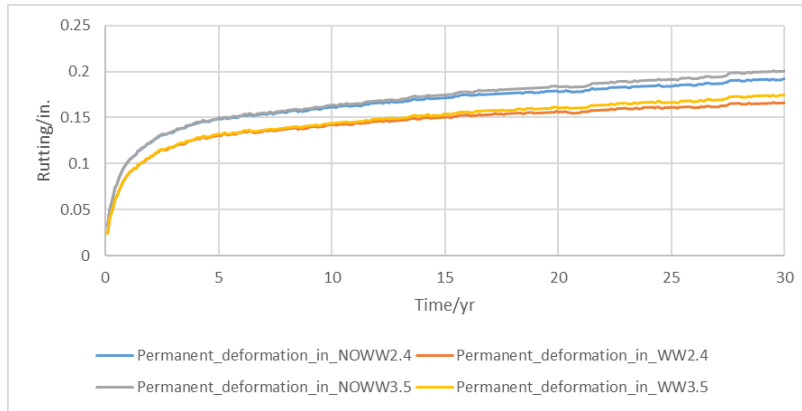
23. Select volume condition(s) when truck platooning would be permitted?
- |                              |                                    |                         |   |                               |
|------------------------------|------------------------------------|-------------------------|---|-------------------------------|
| 1                            | 2                                  | 3                       | 4   | 5                             |
| Low Volume<br>with No Delays | Low Volume<br>with Minor<br>Delays | Volume Near<br>Capacity | Volume at or<br>Slightly Over<br>Capacity | Volume<br>Exceeds<br>Capacity |
24. What infrastructure changes are most needed in automated and platooned truck environment?
- Changes in interchange/Ramp spacing
  - Signage improvements
  - Improved Pavement markings
  - Other
25. Should truck platooning be disengaged in the following area(s)?
- Incident/Accident zones
  - Automated toll gates
  - Work zones
  - Entrance/Exit ramps
  - Upon entering roadside safety rest areas
  - Other:
26. Should there be any restriction(s) in the type of cargo that platooning trucks can transport?
- Project cargo (e.g. windmill blades, bridge beams, oversized equipment, etc.)
  - Standard/Intermodal containers
  - Oversize/overweight trucks
  - Hazardous Materials
  - Other:
27. Who should initiate the formation of a truck platoon?
- Driver(s)
  - Company Operation Center
  - Infrastructure Owner Operator Provided Center
  - Other:
28. Do you anticipate truck platoons taking place in more than one lane at a time?
- Yes
  - No

29. When platooned trucks are not in exclusive truck-lanes, should a platoon be allowed to change lanes?
- Yes
  - No

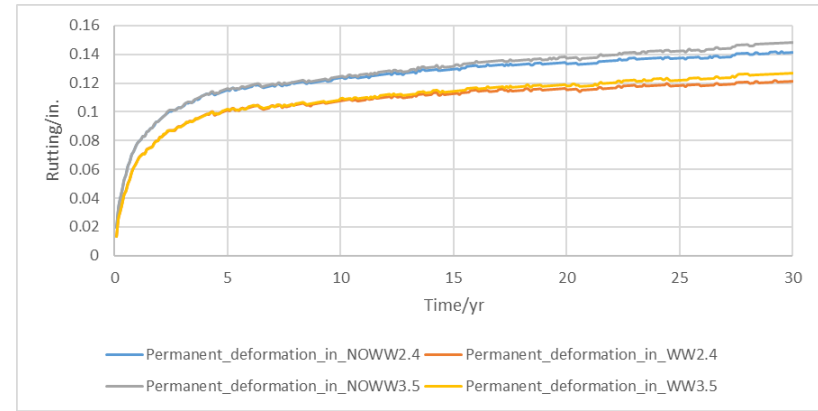
**APPENDIX B. PAVEMENT PERFORMANCE PREDICTION BASED ON  
THE SURFACE AND BASE TYPE COMBINATION**



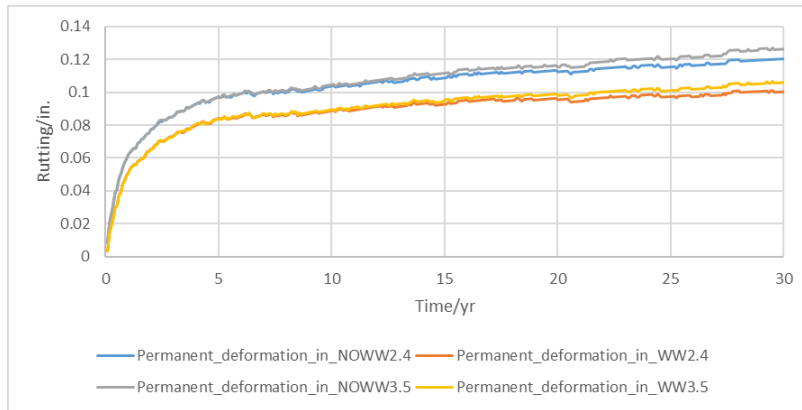
**Figure B.1. Histogram for Pavement Surface and Base Type Combinations.**



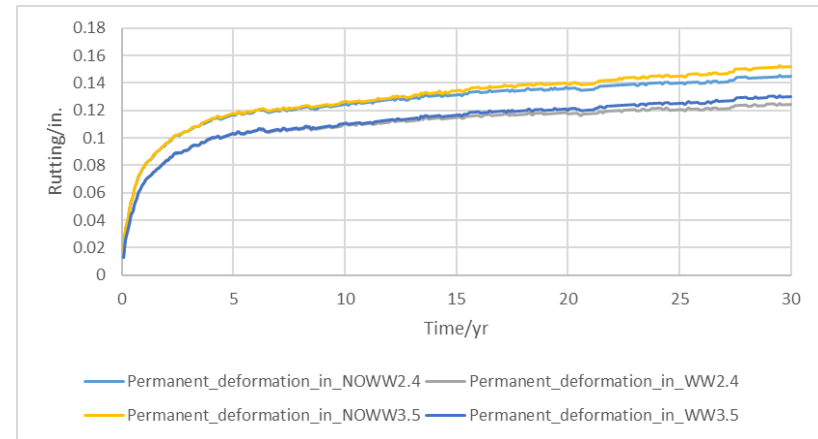
(a)



(b)

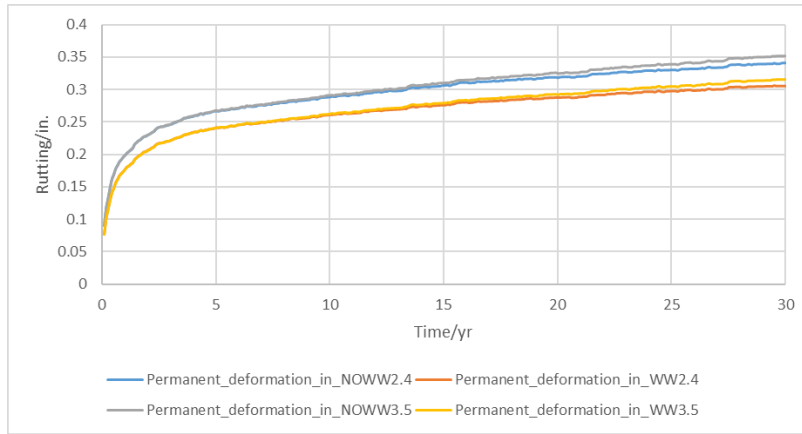


(c)

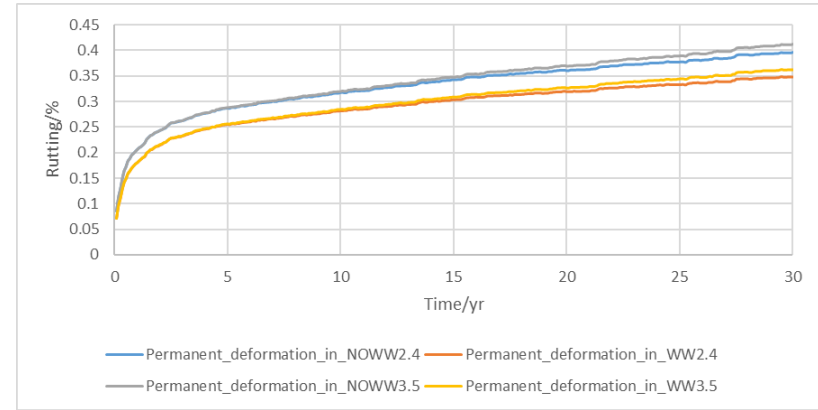


(d)

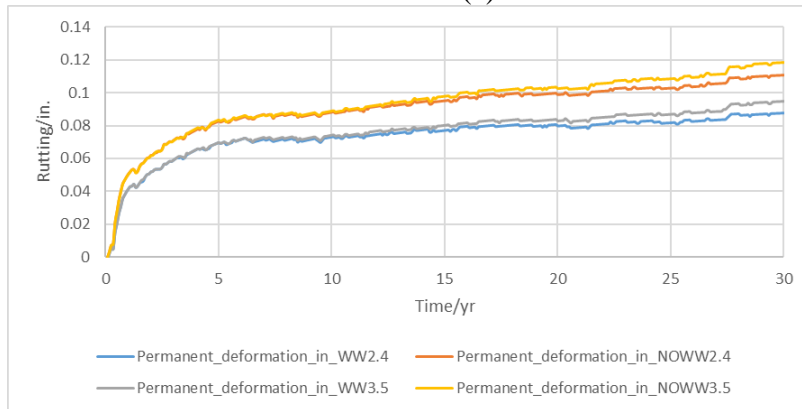
**Figure B.2. Rutting Predictions for Flexible Pavements: (a) thick AC + granular base; (b) thick AC + open-graded base; (c) thick AC + lean concrete base; (d) thick AC + treated base; (e) thick AC + granular base; (f) thick AC + open-graded base; (g) AC + CRCP + lime-treated base; (h) AC + CRCP + lean concrete base; (i) AC + CRCP + open-graded base; (j) AC + CRCP + granular base.**



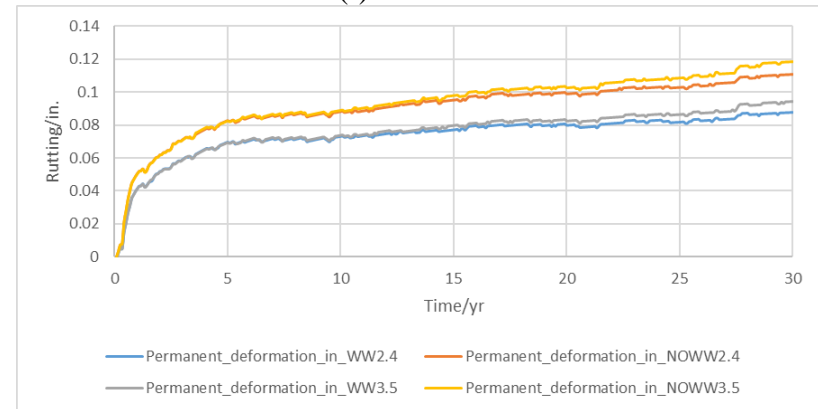
(e)



(f)

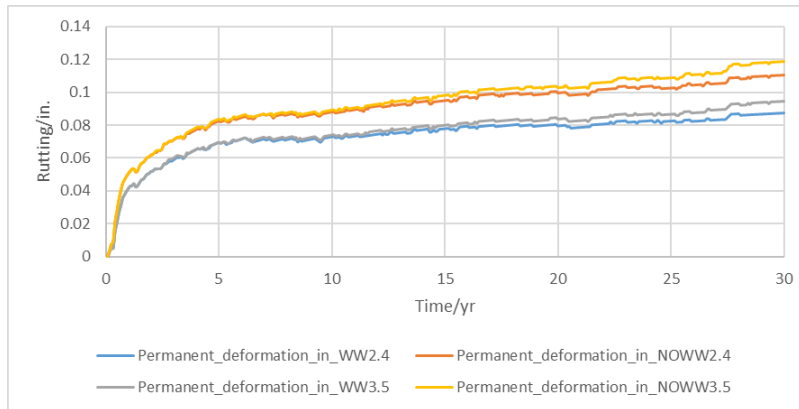


(g)

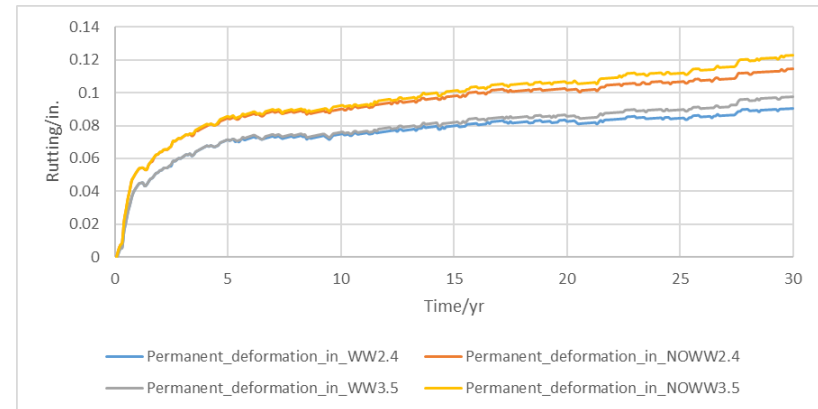


(h)

**Figure B.2. Rutting Predictions for Flexible Pavements: (a) thick AC + granular base; (b) thick AC + open-graded base; (c) thick AC + lean concrete base; (d) thick AC + treated base; (e) thick AC + granular base; (f) thick AC + open-graded base; (g) AC + CRCP + lime-treated base; (h) AC + CRCP + lean concrete base; (i) AC + CRCP + open-graded base; (j) AC + CRCP + granular base (Continued).**

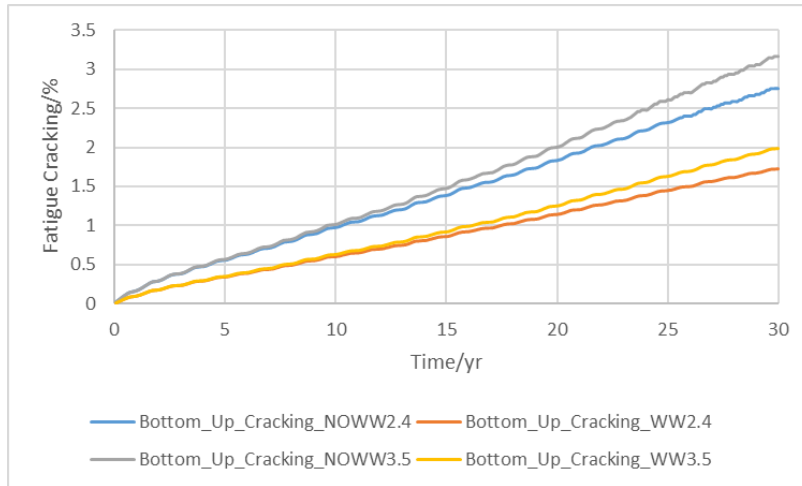


(i)

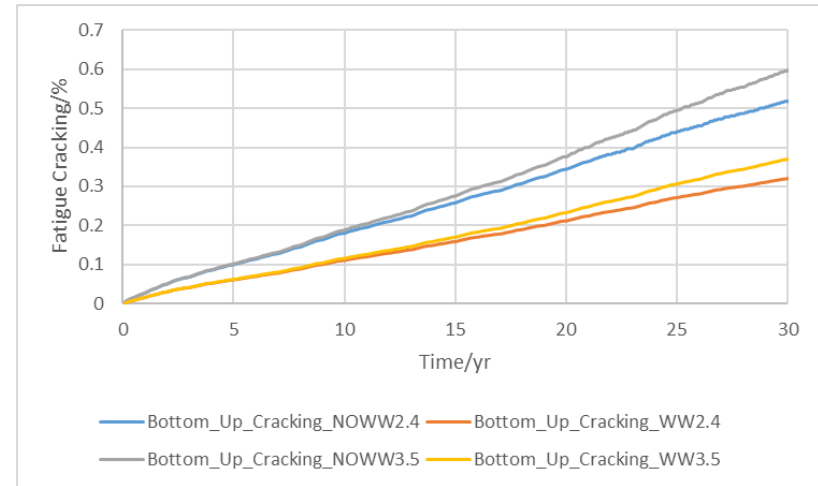


(j)

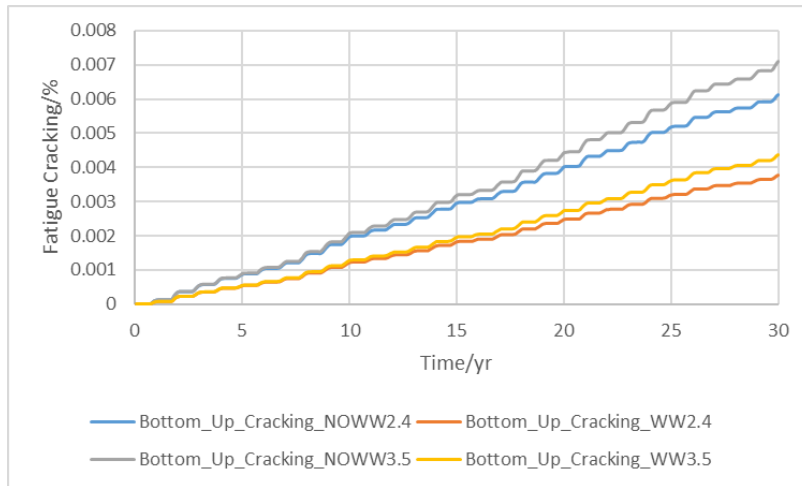
**Figure B.2. Rutting Predictions for Flexible Pavements: (a) thick AC + granular base; (b) thick AC + open-graded base; (c) thick AC + lean concrete base; (d) thick AC + treated base; (e) thick AC + granular base; (f) thick AC + open-graded base; (g) AC + CRCP + lime-treated base; (h) AC + CRCP + lean concrete base; (i) AC + CRCP + open-graded base; (j) AC + CRCP + granular base (Continued).**



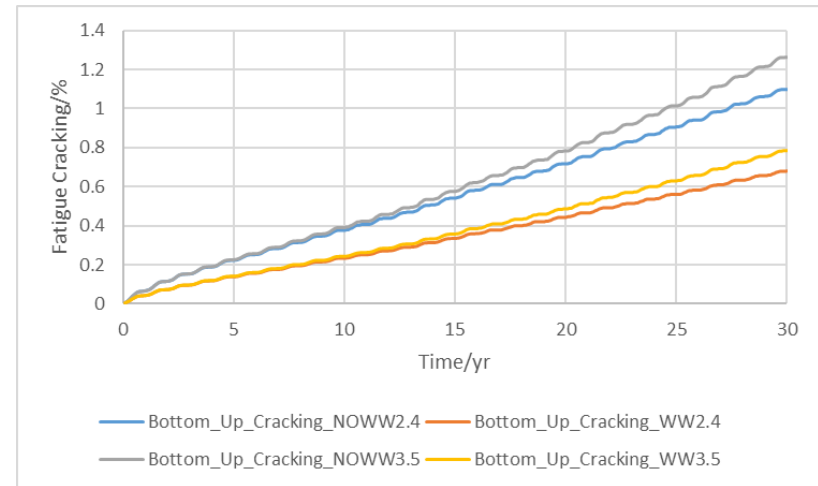
(a)



(b)



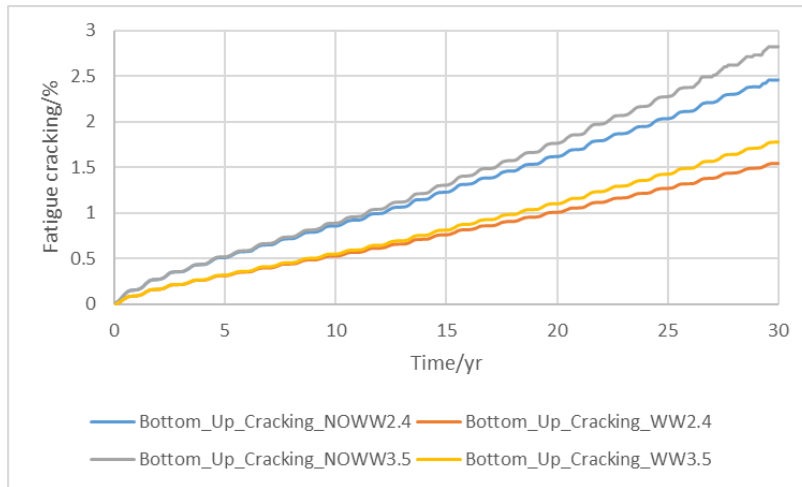
(c)



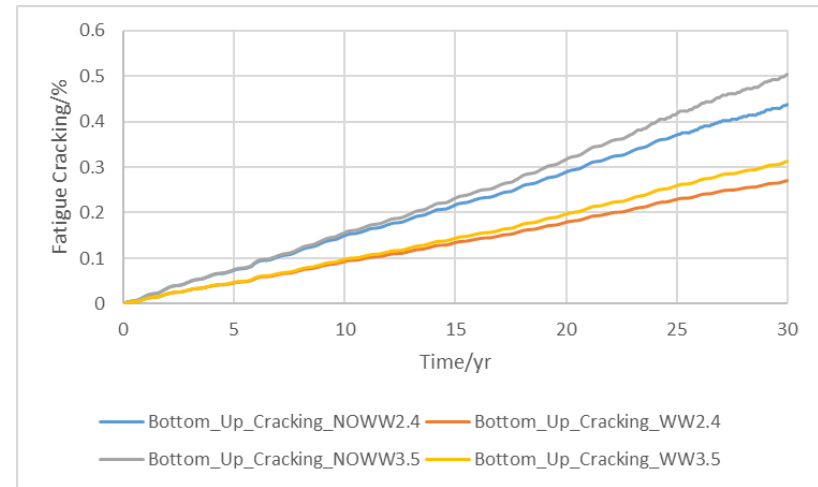
(d)

**Figure B.3. BUC Predictions for Flexible Pavements: (a) thick AC + granular base; (b) thick AC + open-graded base; (c) thick AC + lean concrete base; (d) thick AC + treated base; (e) thick AC + granular base; (f) thick AC + open-graded base; (g) AC + CRCP + lime-treated base; (h) AC + CRCP + lean concrete base; (i) AC + CRCP + open-graded base; (j) AC + CRCP + granular base.**

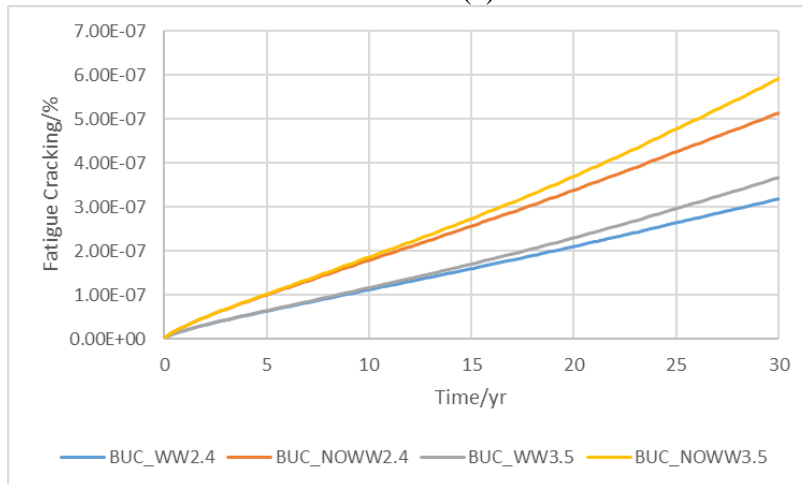




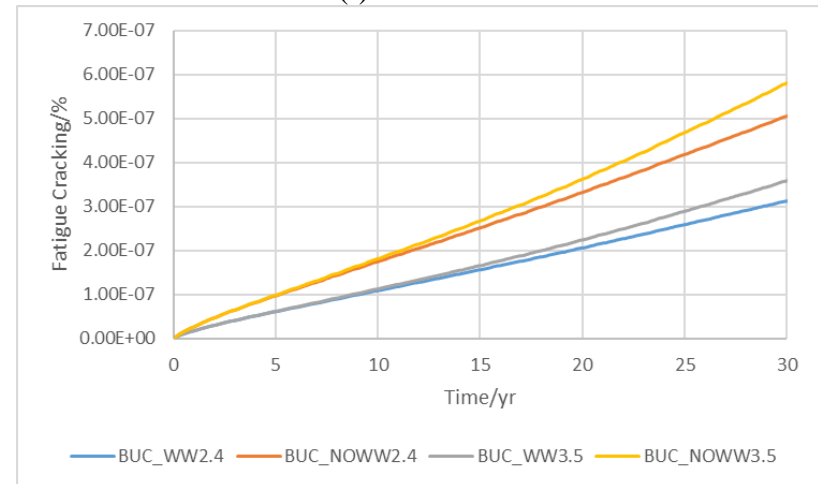
(e)



(f)

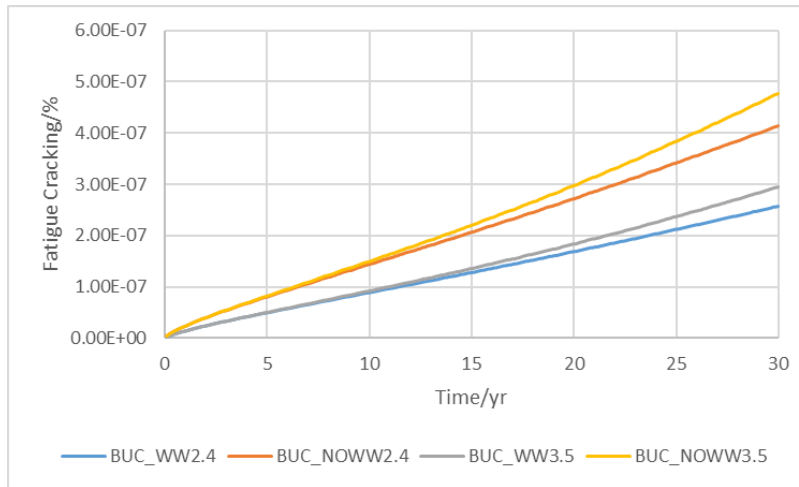


(g)

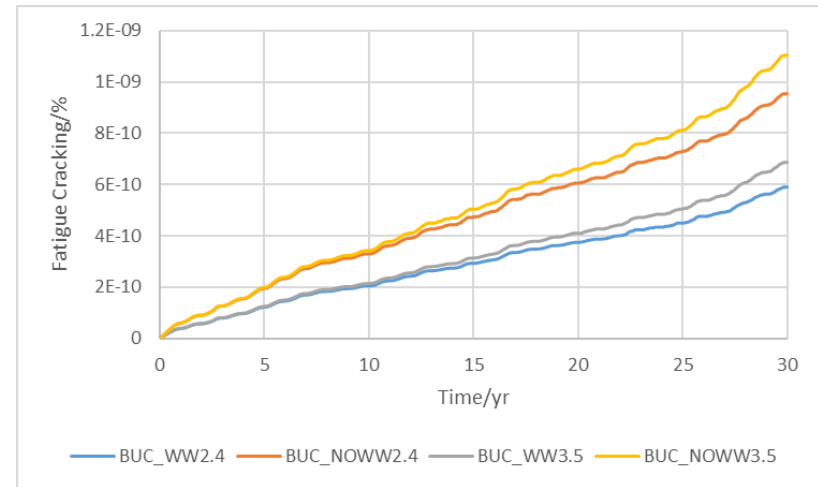


(h)

**Figure B.3. BUC Predictions for Flexible Pavements: (a) thick AC + granular base; (b) thick AC + open-graded base; (c) thick AC + lean concrete base; (d) thick AC + treated base; (e) thick AC + granular base; (f) thick AC + open-graded base; (g) AC + CRCP + lime-treated base; (h) AC + CRCP + lean concrete base; (i) AC + CRCP + open-graded base; (j) AC + CRCP + granular base (Continued).**

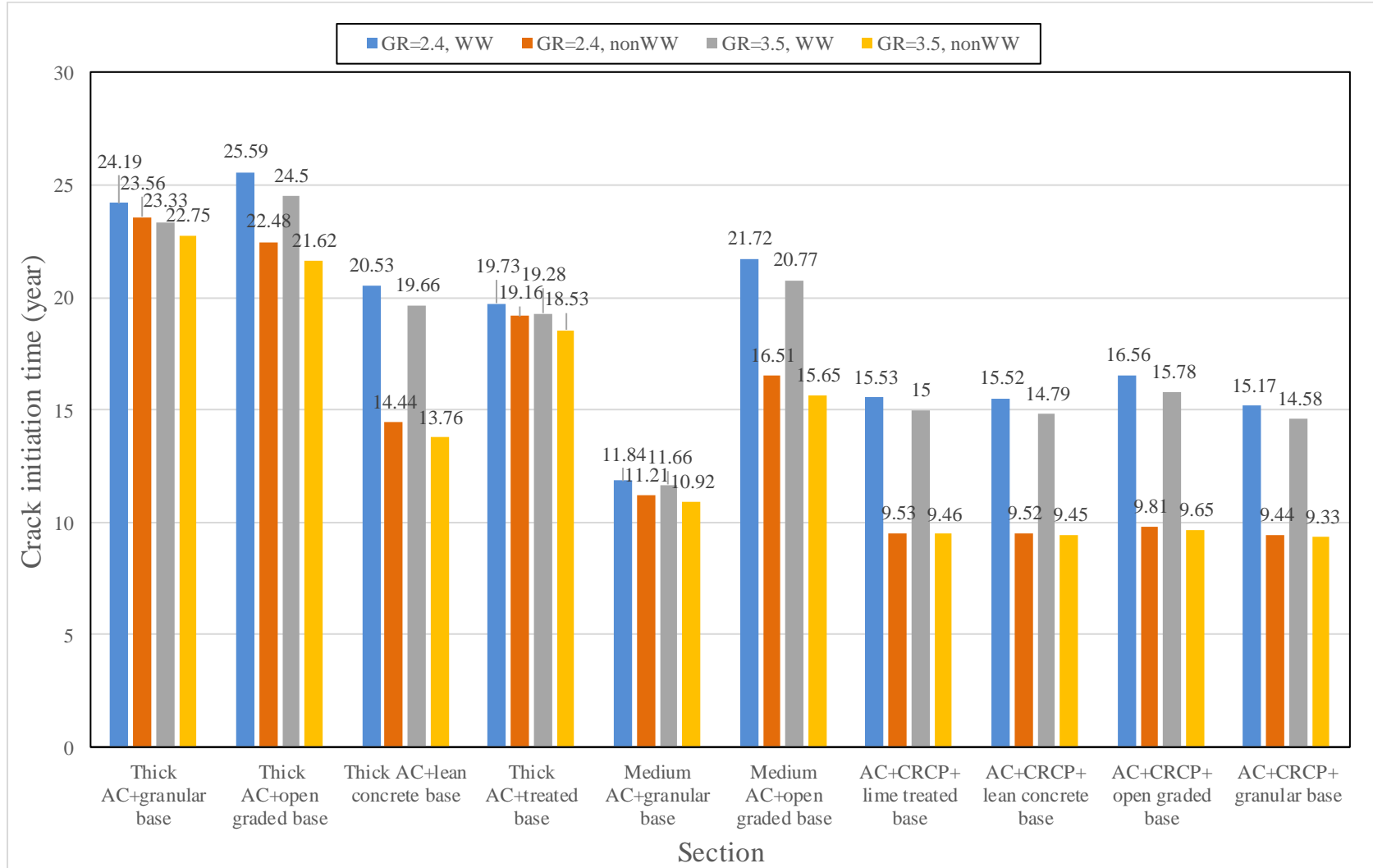


(i)

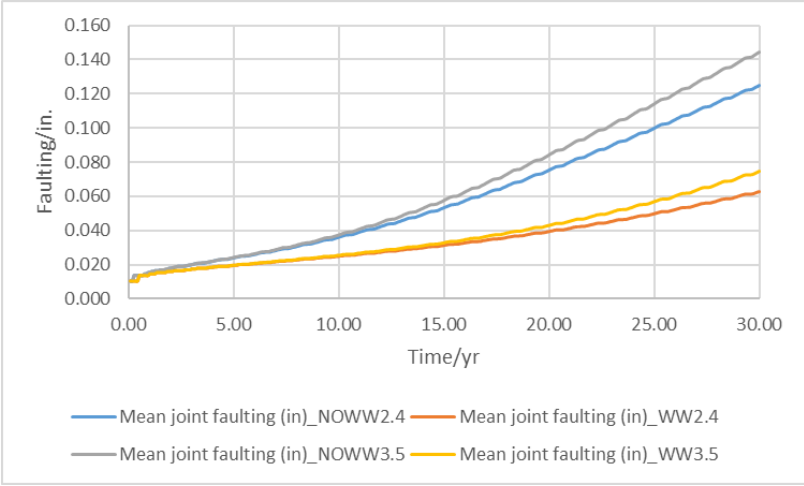


(j)

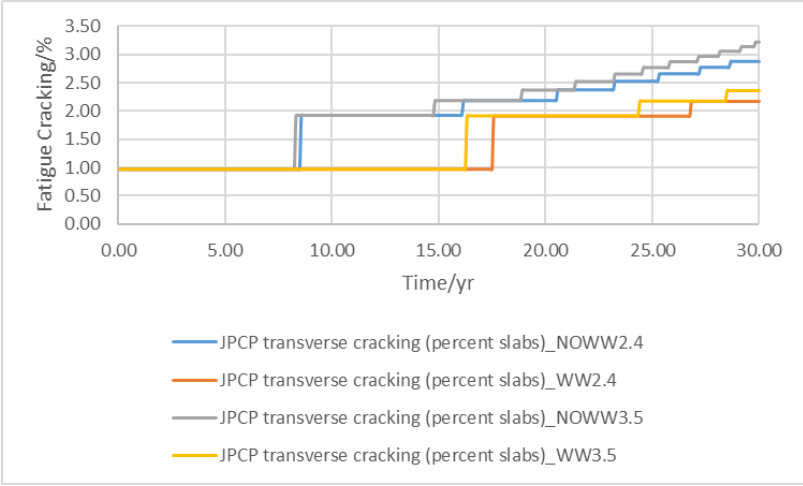
**Figure B.3. BUC Predictions for Flexible Pavements: (a) thick AC + granular base; (b) thick AC + open-graded base; (c) thick AC + lean concrete base; (d) thick AC + treated base; (e) thick AC + granular base; (f) thick AC + open-graded base; (g) AC + CRCP + lime-treated base; (h) AC + CRCP + lean concrete base; (i) AC + CRCP + open-graded base; (j) AC + CRCP + granular base (Continued).**



**Figure B.4. Top-Down Crack Initiation Time for Flexible Pavements.**

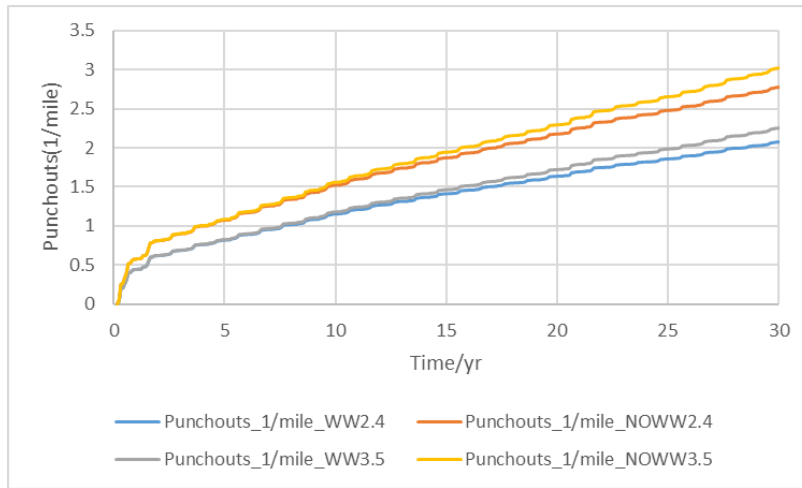


(a)

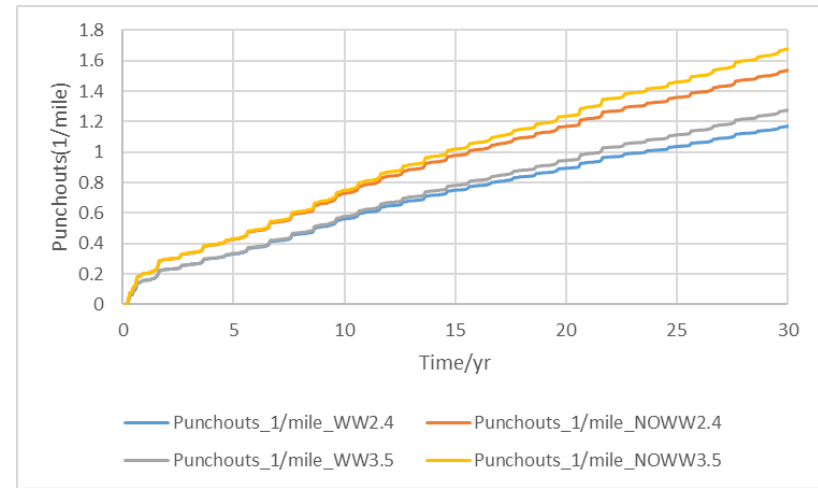


(b)

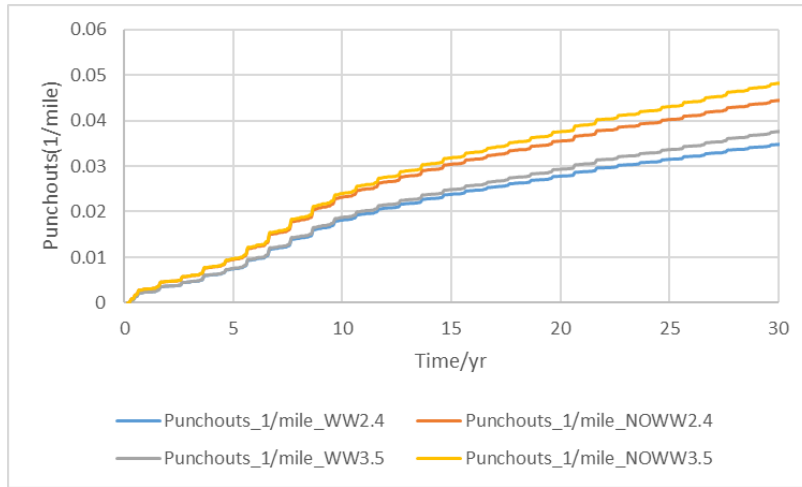
**Figure B.5. (a) Faulting and (b) Transverse Cracking Predictions for JPCP + Granular Base Pavement.**



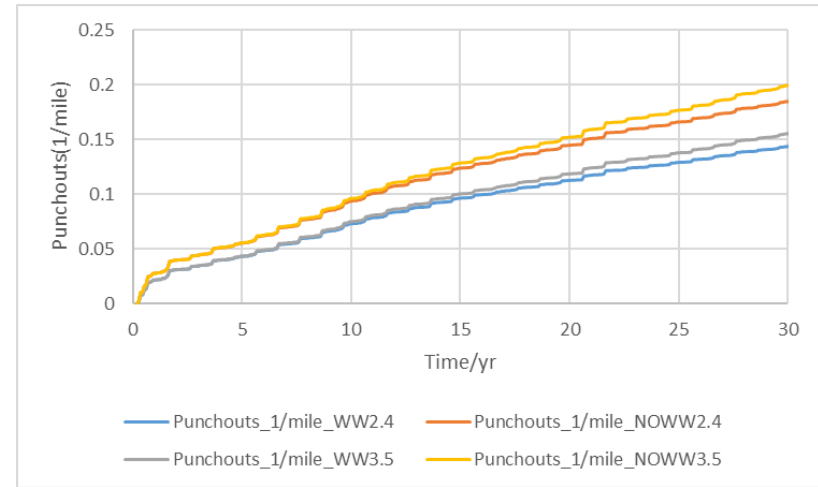
(a)



(b)



(c)



(d)

**Figure B.6. Punchout Predictions for CRCP pavements: (a) CRCP + lime-treated base; (b) CRCP + lean concrete base; (c) CRCP + granular base; (d) CRCP + open-graded base.**



## APPENDIX C. VALUE OF RESEARCH REPORT

### OVERVIEW

A draft value-of-research analysis was performed at the end of the initial two-year project period to:

- Identify appropriate qualitative and economic factors.
- Identify data sources.
- Attempt to define baseline data.
- Plan for further data collection.

### FACTOR IDENTIFICATION

Table C.1 summarizes the factors the Texas Department of Transportation (TxDOT) selected.

**Table C.1. Qualitative and Economic Factors.**

<b>Selected</b>	<b>Functional Area</b>	<b>QUAL</b>	<b>ECON</b>	<b>Both</b>	<b>TxDOT</b>	<b>State</b>	<b>Both</b>
X	Level of Knowledge	X			X		
X	Engineering Design Improvement			X			X

### DATA AND DATA COLLECTION PLAN

#### Level of Knowledge

The findings from this project will produce an overall increase in the level of knowledge of TxDOT employees. If properly communicated, the following information would be available:

- Identification of key options for highway infrastructure hardening actions.
- Understanding of the potential impact of automated and platoon truck traffic on traffic congestion, along with ways to minimize these negative effects.
- Identification of the potential need for dedicated lanes for automated and platoon truck traffic.
- Impacts on the Texas Freight Mobility Plan.
- Impacts on the Statewide Planning/Texas Transportation Plan.
- Identification and documentation of national/state/local-level planning and policy impediments and obstacles.
- Identification at the asset and network levels of the most likely pavement damage mechanisms that may be accelerated due to the introduction of automated and platoon truck traffic.

- Identification of bridge designs in the Texas Highway Freight Network that may benefit from rehabilitation.
- Identification of the impact of truck axle configurations on the increased need for bridge maintenance/rehabilitation.
- Identification of the impact of different truck following distances on the increased need for bridge maintenance/rehabilitation.
- Overall infrastructure costs and benefits associated with the introduction of automated and platoon truck technologies on the Texas Highway Freight Network.

### **Engineering Design Improvement**

The findings from this project may result in the following improvements in engineering design:

- Introduction of hardened dedicated lanes for automated and platoon truck traffic.
- Introduction of auxiliary lanes on transportation corridors designated for automated and platoon truck traffic.
- Introduction of high-PMA pavements on corridors and/or lanes designated for autonomous and platoon truck traffic. This is based on the identification of top-down wheel path cracking as being the most likely pavement damage mechanisms that may be accelerated due to the introduction of automated and platoon truck traffic.
- Identification of bridge designs in the Texas Highway Freight Network that may benefit from rehabilitation.
- Identification of the impact of truck axle configurations on the increased need for bridge maintenance/rehabilitation.
- Identification of the impact of different truck following distances on the increased need for bridge maintenance/rehabilitation.

### **VALUE OF RESEARCH ESTIMATE**

The research team recognizes that the factors listed previously are complex and often interdependent. Therefore, to quantify the economic impact of these factors, the research team focused on the evaluation of three different scenarios, reflecting different degrees of maturity of autonomous and platoon truck traffic on the Texas Highway Freight Network. Furthermore, since many of the benefits are benefits to the whole of Texas, not just TxDOT, the focus was to identify the potential benefits and costs that truck platooning and automation may have on the overall economy of Texas. This was accomplished through the development of scenarios that considered advancements in truck automation over a 30-year study period. The detailed methodology is described under the Task 6 results in the research report.

The first step in the analysis was a scenario development process that included identifying aspects of a long-haul truck trip between an origin and destination, with the initial and final



segments of the trips occurring along arterial roadways and the main middle segment traversing an interstate highway. In the base case, two separate trucks transporting goods would travel independently over the entire corridor. The trip length, under HOS laws, would require 30-minute breaks and 10-hour rest periods. The 30-year analysis period is comprised of a short-term, midterm, and long-term time period, each with increasing levels of platooning and automation. Next, a case study corridor in the state was desired to capture actual values for economic evaluations. The project team investigated three corridors that are long enough to require the HOS breaks and also meet several other criteria, including high traffic volumes, a variety of pavement types, and a population of bridges. The project team decided on the 831-mile corridor between El Paso and Texarkana, which includes I-10, I-20, and I-30. After corridor selection, data were collected for each cost element necessary to conduct the benefit-cost analysis. These elements were grouped into four broad categories:

- Vehicle configuration.
- Vehicle operational environment.
- Safety and labor.
- Infrastructure.

Vehicle configuration included fuel costs, environmental costs, and automation technology costs. The vehicle operational environment included break costs and commodity costs. Safety and labor included driver wages, insurance costs, and accident costs. Infrastructure included bridge and pavement costs. The research team calculated bridge and pavement costs, and based the remaining elements on publicly available data. Using these data, the team conducted a benefit-cost analysis to determine the impacts of truck platooning on the study corridor. The analysis consisted of infrastructure costs to TxDOT, safety and environmental benefits to society, operational benefits to truck companies, and freight benefits to businesses. Thus, the results of the analysis are presented as costs to TxDOT compared to benefits to businesses, consumers, and society.

The analysis used a baseline scenario, representing the status quo, which was compared to a project scenario with increasing levels of truck platooning. The costs in the truck platooning scenario for each element were subtracted from the baseline scenario to generate the project costs and benefits.

The analysis was conducted twice, using a high and low truck growth rate, giving a range of possible results. The analysis was conducted using a 3 percent discount rate, and all costs and benefits were discounted to 2020. The discounted net present value was \$1.9 billion in the low-growth scenario and \$2.4 billion in the high-growth scenario. The benefit-cost ratio was 6.62:1 in the low-growth scenario and 8.42:1 in the high-growth scenario, meaning that for every \$1 spent, there are \$8.42 of benefits in the high-growth scenario. Table C.2 shows the results from the scenarios with low and high truck growth rates. The project team then estimated the economic

impacts using the input-output model IMPLAN. The operational cost savings calculated in the benefit-cost analysis represent the out-of-pocket savings to the trucking industry. These savings will be reinvested in the industry, distributed to shareholders and employees, and/or passed on to the customer and consumers.

**Table C.2. Results of Economic Analysis Based on Scenarios with Low and High Truck Growth Rates.**

Low Growth Scenario							
	Total Costs	Benefits					
		Safety Savings	Environmental Savings	Operations Savings	Freight Savings	Total Savings	Net Benefits
Short Term	\$ 59,670,665	\$ 5,991,015	\$ 21,851,914	\$ 2,985,338	\$ -	\$ 30,828,267	\$ (28,842,398)
Medium Term	\$ 114,237,236	\$ 38,688,677	\$ 41,847,078	\$ 188,461,205	\$ -	\$ 268,996,960	\$ 154,759,724
Long Term	\$ 159,316,330	\$ 186,537,273	\$ 58,383,207	\$ 1,168,887,025	\$ 492,118,120	\$ 1,905,925,625	\$ 1,746,609,294
<b>Total</b>	<b>\$ 333,224,232</b>	<b>\$ 231,216,965</b>	<b>\$ 122,082,200</b>	<b>\$ 1,360,333,567</b>	<b>\$ 492,118,120</b>	<b>\$ 2,205,750,852</b>	<b>\$ 1,872,526,620</b>
High Growth Scenario							
	Total Costs	Benefits					
		Safety Savings	Environmental Savings	Operations Savings	Freight Savings	Total Savings	Net Benefits
Short Term	\$ 51,024,539	\$ 6,120,350	\$ 22,324,530	\$ 3,049,786	\$ -	\$ 31,494,666	\$ (19,529,872)
Medium Term	\$ 105,831,352	\$ 42,820,127	\$ 46,322,751	\$ 208,586,423	\$ -	\$ 297,729,301	\$ 191,897,949
Long Term	\$ 168,673,831	\$ 235,944,751	\$ 73,864,905	\$ 1,478,486,064	\$ 622,463,734	\$ 2,410,759,455	\$ 2,242,085,623
<b>Total</b>	<b>\$ 325,529,722</b>	<b>\$ 284,885,229</b>	<b>\$ 142,512,186</b>	<b>\$ 1,690,122,273</b>	<b>\$ 622,463,734</b>	<b>\$ 2,739,983,422</b>	<b>\$ 2,414,453,700</b>

The economic impact analysis shows the effects of these additional dollars on the Texas economy. The estimated economic impacts are categorized as direct, indirect, or induced. Direct impacts result from the initial change in expenditures to the truck transportation industry, indirect impacts arise from the operations of the truck transportation industry (i.e., suppliers), and induced impacts are from household spending of direct and indirect wages. For this analysis, the direct jobs and income were reported as zero in the midterm and long-term scenarios to signal the reduction of drivers in the case study example. This reflects the loss of direct employment and does not calculate a direct employment gain based on the transportation savings. However, the increase in production dollars to the truck transportation industry will result in indirect and induced jobs. The economic analysis was performed for three individual years: 2021, 2026, and 2036. These represent the first operational year of each scenario: near term, midterm, and long term. All monetary results are in 2020 dollars. Overall, the 2.4 percent growth rate results in an estimated \$1.4 million in economic output for the near-term scenario in 2021. This increases annually to \$36.7 million for the midterm scenario in 2026 and \$154.1 million for the long-term scenario in 2036. The 3.5 percent growth rate results in an estimated \$38.8 million for the midterm scenario in 2026 and \$180.9 million for the long-term scenario in 2036. Table C.3 shows the results of the overall economic analysis including a benefit-cost ratio.


**Table C.3. Results of Economic Analysis Including a Benefit-Cost Ratio.**

<b>Low Growth Scenario Results</b>	<b>Undiscounted</b>	<b>Discounted</b>
Total Pavement Cost	\$504,457,000	\$312,817,000
Total Bridge Cost	\$32,910,000	\$20,407,000
<b>Total Cost</b>	<b>\$537,367,000</b>	<b>\$333,224,000</b>
Total Safety Benefit	\$429,399,000	\$231,217,000
Total Environmental Benefit	\$196,887,161	\$122,082,000
Total Operations Benefit	\$2,579,162,000	\$1,360,334,000
Total Freight Benefit	\$976,033,000	\$492,118,000
<b>Total Benefit</b>	<b>\$4,181,481,000</b>	<b>\$2,205,751,000</b>
<b>Net Present Value</b>	<b>\$3,644,115,000</b>	<b>\$1,872,527,000</b>
<b>Benefit Cost Ratio</b>	<b>7.78:1</b>	<b>6.62:1</b>

In summary, the current research project has studied and identified the potential impacts, benefits, impediments, and solutions for enabling automated trucks and truck platooning on Texas highway infrastructure. The results of the project include the new knowledge that supports planning, policy, and engineering design, as well as specific engineering design improvement recommendations for enabling truck automation and platooning on Texas highways. The benefits summarized in Table C.3 are indicators of the overall economic benefits to Texas.

Table C.4 summarizes the value of research for the project.

**Table C.4. Value of Research.**

	<b>Project #</b>	0-6984	
	<b>Project Name:</b>	Evaluate Potential Impacts, Benefits, Impediments, and Solutions of Automated Trucks and Truck Platooning on Texas Highway Infrastructure	
	<b>Agency:</b>	TTI	<b>Project Budget</b> \$ 448,240
	<b>Project Duration (Yrs)</b>	2.00	<b>Exp. Value (per Yr)</b> \$ 62,417,567
<b>Expected Value Duration (Yrs)</b>		30	<b>Discount Rate</b> 3%
<b>Economic Value</b>			
<b>Total Savings:</b>	\$ 2,205,751,000	<b>Net Present Value (NPV):</b>	\$ 1,872,527,000
<b>Payback Period (Yrs):</b>	0.007181	<b>Cost Benefit Ratio (CBR, \$1 : \$___):</b>	\$ 4,178

Low Growth Scenario Results	Undiscounted	Discounted
Total Pavement Cost	\$504,457,000	\$312,817,000
Total Bridge Cost	\$32,910,000	\$20,407,000
<b>Total Cost</b>	<b>\$537,367,000</b>	<b>\$333,224,000</b>
Total Safety Benefit	\$429,399,000	\$231,217,000
Total Environmental Benefit	\$196,887,161	\$122,082,000
Total Operations Benefit	\$2,579,162,000	\$1,360,334,000
Total Freight Benefit	\$976,033,000	\$492,118,000
<b>Total Benefit</b>	<b>\$4,181,481,000</b>	<b>\$2,205,751,000</b>
<b>Net Present Value</b>	<b>\$3,644,115,000</b>	<b>\$1,872,527,000</b>
<b>Benefit Cost Ratio</b>	<b>7.78:1</b>	<b>6.62:1</b>

**Variable Justification**

3% is a reasonable discount rate for assessing the economic costs of public works and the benefits of transportation on the economy. The payback period assumes that TxDOT is already experiencing the onset of the early scenario of truck automation and platooning, with private companies already piloting autonomous trucks on Texas highways.

**Qualitative Value**

Benefit Area	Value
Level of Knowledge	Better understanding of key design, pavement, and bridge asset hardening options to minimize or eliminate negative impacts of pavements and bridges on corridors being considered for automated truck traffic. Understanding the potential impacts of automated and platoon truck traffic on congestion, along with actions to minimize these effects. Understanding of the impacts on the Texas Freight Mobility Plan, as well as impacts on the Statewide Texas Transportation Plan and identification of national/state/local-level planning and policy impediments and obstacles. Identification of the impact of different truck axle configurations and truck platooning following distances on needs for early bridge maintenance actions. Knowledge of the overall costs and benefits associated with the introduction of automated and platoon truck technologies for Texas.
Engineering Design Improvement	Recommendations of key design changes and infrastructure hardening actions to minimize the negative impact of truck automation and platooning on Texas highways.