

|  |  |   |   |  |           |
|--|--|---|---|--|-----------|
| 1. Report No.<br>FHWA/TX-11/0-6581-TI-2  |  | 2. Government Accession No.                         |   | 3. Recipient's Catalog No.   |           |
| 4. Title and Subtitle<br>TXDOT ADMINISTRATION RESEARCH: TASKS COMPLETED<br>FY2010  |  |   |   | 5. Report Date<br>January 2011<br>Published: February 2011                               |           |
|  |  |   |   | 6. Performing Organization Code  |           |
| 7. Author(s)<br>Richard Baker, Liang Ding, Jon Epps, Cindy Estakhri, Gary Fry<br>Tina Geiselbrecht, Ginger Goodin, Joan Hudson, Tim Lomax,<br>Curtis Morgan, John Orsak, David Schrank, Tom Scullion, William<br>Stockton, Steven Venglar, Juan Villa, Bryan Wood, Dave Winterich,<br>Robert Lee, and Joe Zietsman |  |   |   | 8. Performing Organization Report No.<br>Report 0-6581-TI-2                              |           |
| 9. Performing Organization Name and Address<br>Texas Transportation Institute<br>The Texas A&M University System<br>College Station, Texas 77843-3135  |  |   |   | 10. Work Unit No. (TRAIS)  |           |
|  |  |   |   | 11. Contract or Grant No.<br>Project 0-6581-TI   |           |
| 12. Sponsoring Agency Name and Address<br>Texas Department of Transportation<br>Research and Technology Implementation Office<br>P.O. Box 5080<br>Austin, Texas 78763-5080   |  |   |   | 13. Type of Report and Period Covered<br>Technical Report:<br>September 2009–August 2010 |           |
|  |  |   |   | 14. Sponsoring Agency Code   |           |
| 15. Supplementary Notes<br>Project performed in cooperation with the Texas Department of Transportation and the Federal Highway Administration.<br>Project Title: TxDOT Administration Research<br>URL: <a href="http://tti.tamu.edu/documents/0-6581-TI-2.pdf">http://tti.tamu.edu/documents/0-6581-TI-2.pdf</a>  |  |   |   |  |           |
| 16. Abstract<br>This research project evaluates numerous transportation issues and develops findings and/or recommendations based on results. This project has been structured to address some of the emerging, critical, and unique considerations related to transportation.                                     |  |   |   |  |           |
| 17. Key Words<br>Focus Groups, Simulation, Ferry, Movable Steel Bridges, Ferry Ramps, Field Measurements, Fatigue Strength   |  |   | 18. Distribution Statement<br>No restrictions. This document is available to the public through NTIS:<br>National Technical Information Service<br>Springfield, Virginia 22161<br><a href="http://www.ntis.gov">http://www.ntis.gov</a> |  |           |
| 19. Security Classif.(of this report)<br>Unclassified  |  | 20. Security Classif.(of this page)<br>Unclassified |   | 21. No. of Pages<br>504  | 22. Price |



**TxDOT ADMINISTRATION RESEARCH:  
TASKS COMPLETED FY2010**

by

Richard Baker  
Associate Transportation  
Researcher  
Texas Transportation Institute

Liang Ding  
Assistant Research Engineer  
Texas Transportation Institute

Jon Epps  
Executive Associate  
Agency Director  
Texas Transportation Institute

Cindy Estakhri  
Program Manager  
Texas Transportation Institute

Gary Fry  
Associate Professor  
Texas A&M University

Tina Geiselbrecht  
Assistant Research Scientist  
Texas Transportation Institute

Ginger Goodin  
Senior Research Engineer  
Texas Transportation Institute

Joan Hudson  
Associate Research Engineer  
Texas Transportation Institute

Tim Lomax  
Research Engineer  
Texas Transportation Institute

Curtis Morgan  
Program Manager  
Texas Transportation Institute

John P. Orsak  
Graduate Research Assistant  
Texas A&M University

David Schrank  
Associate Research Scientist  
Texas Transportation Institute

Tom Scullion  
Program Manager  
Texas Transportation Institute

William Stockton  
Executive Associate Agency  
Director  
Texas Transportation Institute

Steven Venglar  
Research Engineer  
Texas Transportation Institute

Juan Villa  
Manager of Economics,  
Trade, and Logistics Program  
Texas Transportation Institute

Bryan Wood  
Research Engineer  
Texas Transportation Institute

Dave Winterich  
Research Associate  
Texas Transportation Institute

Robert Lee  
Construction Division,  
Materials & Pavements Section  
TxDOT

Joe Zietsman  
Center Director  
Texas Transportation Institute

Report 0-6581-TI-2  
Project 0-6581-TI  
Project Title: TxDOT Administration Research

Performed in cooperation with the  
Texas Department of Transportation  
and the  
Federal Highway Administration

January 2011  
Published: February 2011

TEXAS TRANSPORTATION INSTITUTE  
The Texas A&M University System  
College Station, Texas 77843-3135



## **DISCLAIMER**

This research was performed in cooperation with the Texas Department of Transportation (TxDOT) and the Federal Highway Administration (FHWA). The contents of this report reflect the views of the authors, who are responsible for the facts and the accuracy of the data presented herein. The contents do not necessarily reflect the official view or policies of the FHWA or TxDOT. This report does not constitute a standard, specification, or regulation. We extend special thanks to Mr. Rick Collins, Mr. Lewis Gamboa, Mr. David Hohmann, Mr. Michael Hyzak, Mr. Russel Lenz, Mr. Kevin Pruski, and Mr. Lloyd Wolf. We wish to recognize several TxDOT staff who provided special assistance, guidance, and insight for a large number of important issues related to the design and installation of the instrumentation: Mr. Howard Gillespie, Mr. Bill Gunn, Mr. Nolan Holik, and Mr. Mark Hughes.

## **ACKNOWLEDGMENTS**

This project was conducted in cooperation with TxDOT and FHWA. The researchers thank all the individuals and groups that contributed to the project, and express particular appreciation for the guidance and technical assistance provided by Caroline Herrera, P.E., Lisa Lukefahr, P.E., Tomas Saenz, P.E., and Rodney Concienne, P.E., of TxDOT.

This report is a compilation of documents developed during FY10.

# TABLE OF CONTENTS

|   | Page        |
|---|-------------|
| <b>LIST OF FIGURES</b> .....  | <b>x</b>    |
| <b>LIST OF TABLES</b> .....   | <b>xiii</b> |
| <b>WORK REQUEST FIVE: Phase II Final Report: Public Perceptions Regarding the<br/>Texas Department of Transportation: Focus Group Results</b> .....   | <b>1</b>    |
| Executive Summary .....   | 1           |
| Full Report .....   | 5           |
| Appendix A: Summary of Notes by Focus Group .....   | 21          |
| Appendix B: Allocation Surveys .....  | 31          |
| Appendix C: Funding Allocation Survey Results .....   | 37          |
| Appendix D: Funding Allocation Comments .....   | 39          |
| Appendix E: Demographics of Focus Groups .....  | 42          |
| Appendix F: Video Questionnaire Results .....   | 43          |
| <b>PHASE III FINAL REPORT: Public Perceptions Regarding the Draft 2011 to 2015<br/>Strategic Plan of TxDOT—Focus Group Results</b> .....              | <b>61</b>   |
| Executive Summary .....   | 61          |
| Full Report .....   | 65          |
| Appendix A: Notes for Each Focus Group .....  | 80          |
| Appendix B: Demographics of Focus Groups .....  | 93          |
| Appendix C: Discussion Guide .....  | 95          |
| Appendix D: Draft 2011–2015 Strategic Plan of TxDOT .....   | 99          |
| Appendix E: Slides Presented to Focus Groups .....  | 109         |
| <b>WORK REQUEST EIGHT: Developing a Congestion Performance Measure<br/>Subcommittee Concept Paper</b> .....   | <b>113</b>  |
| Summary .....   | 113         |
| The Concept and Framework .....   | 115         |
| Measurement Specs .....   | 117         |
| Describing the Measures .....   | 118         |
| Other Measurement Issues .....  | 120         |
| <b>WORK REQUEST NINE: Analysis Procedures and Mobility Performance<br/>Measures 100 Most Congested Texas Road Sections</b> .....                      | <b>121</b>  |
| The Data Improvements - Overview .....  | 121         |
| Change From the 2009 Most Congested List .....  | 124         |
| <b>WORK REQUEST TEN: Congestion Estimation for Texas Road Improvements<br/>Methodology Description for Propositions 12 and 14, and Rider 55</b> ..... | <b>127</b>  |
| Analysis Steps .....  | 127         |

|   |            |
|---|------------|
| <b>WORK REQUEST ELEVEN: Interstate 35 Citizens’ Advisory Committee Public Outreach Task.....</b>  | <b>135</b> |
| Focus Group Results .....   | 135        |
| Business Listening Session Results .....  | 275        |
| <br>  |            |
| <b>WORK REQUEST TWELVE: Use of Copper and Lead Slag in Highway Construction: Literature Search – Materials Use and Construction Considerations.....</b> | <b>339</b> |
| Introduction.....   | 339        |
| Chemical Composition of Copper and Lead Slag.....   | 341        |
| Department Material Specification 11000 Testing .....   | 343        |
| Physical Engineering Properties of Copper and Lead Slag .....   | 344        |
| Applications of Copper and Lead Slag in Highway Construction.....   | 346        |
| Proposed Laboratory Evaluation of ASARCO Material.....  | 348        |
| Current Remediation Activities Planned for the ASARCO Site.....   | 350        |
| Possible TxDOT Construction through the ASARCO Site .....   | 352        |
| Recommendations and Future Work Needed .....  | 353        |
| References.....   | 354        |
| Appendix A: Advanced Test Equipment Required to Measure Chemical Composition of Slags.....  | 357        |
| Appendix B: Recommended Laboratory Leachate Tests.....  | 359        |
| Appendix C: Recommended Field Leachate Tests with Lysimeter.....  | 361        |
| Appendix D: Item 221 Soil and Groundwater Management Plan(s).....   | 363        |
| <br>  |            |
| <b>WORK REQUEST THIRTEEN: Investigation of Problems with Ramp Bearing Assemblies and Possible Solutions at the Port Aransas Ferry Ramps.....</b>        | <b>367</b> |
| Task 1 Report: Research and Investigation.....  | 367        |
| Task 2 Report: Install Instrumentation and Monitor.....   | 367        |
| Task 3 Report: Retrieve Data.....   | 368        |
| Task 4 Technical Memorandum: Analyze Data—Research Alternate Designs/Details/Systems.....   | 368        |
| <br>  |            |
| <b>WORK REQUEST FOURTEEN: Alternative Fuels Scanning Project: Electric Vehicle Literature Review Summary.....</b>                                       | <b>387</b> |
| Introduction.....   | 387        |
| Summary of Electric Vehicle Use Status .....  | 390        |
| Focus Review Areas.....   | 391        |
| Common Acronyms .....   | 392        |
| California Incentives .....   | 394        |
| New York Incentives.....  | 398        |
| Illinois Incentives.....  | 398        |
| Pennsylvania Incentives .....   | 399        |
| Ohio Incentives .....   | 400        |
| Michigan Incentives .....   | 400        |
| Georgia Incentives .....  | 401        |
| North Carolina Incentives .....   | 402        |



|   |            |
|---|------------|
| <b>WORK REQUEST FIFTEEN: Examination of Port Aransas Ferry Operations for the Corpus Christi District.....</b>  | <b>405</b> |
| Current Operations .....  | 405        |
| Upcoming Changes .....  | 407        |
| Previous Studies .....  | 408        |
| Methodology .....   | 408        |
| Optional Control Strategies.....  | 412        |
| Results .....   | 413        |
| References .....  | 415        |
| <br>  |            |
| <b>WORK REQUEST SIXTEEN: Support for Preparation of Paper and Abstract on “Reducing Green House Gas Emissions in Asphalt Paving Operations” .....</b> | <b>417</b> |
| Abstract from Green Streets and Highway Conference, November 14–17, 2010, Denver Colorado .....   | 417        |
| Reducing Green House Gas Emission in Asphalt Paving Operations .....  | 418        |
| <br>  |            |
| <b>WORK REQUEST SEVENTEEN: Assist with Application for Federal Railroad Administration HSIPR Program.....</b>   | <b>427</b> |
| Houston to Beaumont/Louisiana State Line Corridor.....  | 427        |
| Houston to Austin Corridor Plus New Analysis to Include College Station/Bryan in Corridor Analysis .....  | 434        |
| Dallas to San Antonio and San Antonio to Brownsville via Laredo Corridor Overview .....   | 445        |
| San Antonio to Brownsville via Laredo.....  | 458        |
| San Antonio to Brownsville via Corpus Christi.....  | 466        |
| Dallas-Fort Worth to Houston Corridor Overview .....  | 472        |
| Houston to Dallas via College Station/Bryan and Waco Corridor Option .....  | 480        |

## LIST OF FIGURES

|  | <b>Page</b> |
|--|-------------|
| Figure 1. Sample Flyer Used for Recruitment in Targeted Locations.....   | 8           |
| Figure 2. Flyer as It Appeared in the Newspaper Advertisements.....  | 9           |
| Figure 3. Goal: Effective Agency Organization.....   | 66          |
| Figure 4. Goal: Facilitate Comprehensive Funding Strategies.....   | 68          |
| Figure 5. Goal: Maintain the Existing Transportation System.....   | 70          |
| Figure 6. Goal: Promote Congestion Relief Strategies.....  | 72          |
| Figure 7. Goal: Enhance System Connectivity.....   | 74          |
| Figure 8. Goal: Enhance Safety for All System Users.....   | 75          |
| Figure 9. Displaying the Effect of Additional Investment on Congestion Levels: an<br>Example of Performance Measurement Analysis Results.....                                | 120         |
| Figure 10. (1) Speed Comparison (Old versus New) for Typical High Congestion Free<br>Section; (2) Speed Comparison (Old versus New) for a Bottleneck Freeway<br>Section..... | 125         |
| Figure 11. Sample Flyer Used for Recruitment of Participants for General Population<br>Focus Groups.....   | 141         |
| Figure 12. Sample Flyer Used for Recruitment of Participants for Business Listening<br>Sessions.....   | 143         |
| Figure 13. Sample Newspaper Advertisements.....  | 144         |
| Figure 14. Gender of Focus Groups’ Participants and Associated Counties.....   | 147         |
| Figure 15. Age of Focus Groups’ Participants and Associated Counties.....  | 148         |
| Figure 16. Race and Ethnicity of Focus Groups’ Participants and Associated Counties.....   | 149         |
| Figure 17. Educational Attainment of Focus Groups’ Participants and Associated<br>Counties.....  | 149         |
| Figure 18. Household Income of Focus Groups’ Participants and Associated Counties.....   | 150         |
| Figure 19. ASARCO Plant in El Paso.....  | 339         |
| Figure 20. General Process Diagram for Copper and Lead Slag Production.....  | 340         |
| Figure 21. Examples of the Range of Slag Particle Sizes at El Paso Plant.....  | 340         |
| Figure 22. Slag in Old HMA Cores from the Bryan District.....  | 346         |
| Figure 23. Website Developed for the ASARCO Clean Up.....  | 351         |
| Figure 24. JEOL 6400 Scanning Electron Microscope at Texas A&M University.....   | 357         |
| Figure 25. Cameca SX50 Electron Microprobe at Texas A&M University.....  | 357         |
| Figure 26. Backscattered Electron Image, Taken with The Electron Microprobe, Showing<br>How Different Elements Are Bonded Together in a Meteorite.....                       | 358         |
| Figure 27. Column Apparatus (Adopted from ASTM D4874-06b).....   | 360         |
| Figure 28. Field Site to Capture Leachates from Experimental Bases.....  | 361         |
| Figure 29. Photograph of Cracked Bearing Assembly.....   | 368         |
| Figure 30. Structural Layout of Typical Ferry Ramp and Location of Instrumentation.....  | 370         |
| Figure 31. Photograph of Deck Panel Being Removed at End of Ramp.....  | 372         |
| Figure 32. Photograph of Instruments with Cables Attached Ready to be Installed.....   | 373         |
| Figure 33. Photograph of Positioning Marks at Each Sensor Location prior to Grinding.....  | 373         |
| Figure 34. Photograph of Sensor Locations after Grinding.....  | 374         |
| Figure 35. Photograph of Typical Sensor as Installed.....  | 374         |
| Figure 36. Photograph of Sensor Installation after Priming and Painting.....   | 375         |

|  |     |
|--|-----|
| Figure 37. Photograph of Stringer Ends after All Sensors Installed.....  | 375 |
| Figure 38. Photograph Showing Cable Being Bundled and Routed from Ramp to Out-Building.....  | 376 |
| Figure 39. Photograph Showing Cable Bundle Entering Out-Building.....  | 376 |
| Figure 40. Photograph Showing Data Acquisition System in Out-Building with All Sensors Installed and Operational.....                    | 377 |
| Figure 41. Photograph of Deck Panel Being Replaced.....  | 377 |
| Figure 42. Photograph of Ramp at Completion of Sensor Installation.....  | 378 |
| Figure 43. Cumulative Distribution of Force in Stringer Number 1.....  | 379 |
| Figure 44. Cumulative Distribution of Force in Stringer Number 2.....  | 379 |
| Figure 45. Cumulative Distribution of Force in Stringer Number 3.....  | 380 |
| Figure 46. Cumulative Distribution of Force in Stringer Number 4.....  | 380 |
| Figure 47. Cumulative Distribution of Force in Stringer Number 5.....  | 381 |
| Figure 48. Cumulative Distribution of Force in Stringer Number 6.....  | 381 |
| Figure 49. Cumulative Distribution of Force in Stringer Number 7.....  | 382 |
| Figure 50. Cumulative Distribution of Force in Stringer Number 8.....  | 382 |
| Figure 51. Cumulative Distribution of Force in Stringer Number 9.....  | 383 |
| Figure 52. Cumulative Distribution of Force in Stringer Number 10.....   | 383 |
| Figure 53. Cumulative Distribution of Force in Stringer Number 11.....   | 384 |
| Figure 54. Port Aransas Ferry/SH 361 at Corpus Christi Channel.....  | 406 |
| Figure 55. SH 361 Ferry Wait Signing along Harbor Island Approach.....   | 406 |
| Figure 56. Port Aransas Route Alternatives from I-37.....  | 407 |
| Figure 57. VAP Logic for Ferry System Vehicle and Ferry Traffic Control.....   | 410 |
| Figure 58. Old and New Ferry Boat Designs (as Modeled in VISSIM).....  | 411 |
| Figure 59. VISSIM Representation of Port Aransas Ferry Operations.....   | 411 |
| Figure 60. Port Aransas Ferry Operation Scenarios in VISSIM (Harbor Island Approach).....  | 412 |
| Figure 61. Peak Hour Queue Length Comparisons – Existing and Modified Ferry Fleet.....   | 414 |
| Figure 62. Effect of Technologies on Hot Mix Asphalt Used, Percent.....  | 422 |
| Figure 63. Effect of Technologies on Annual CO <sub>2</sub> eq Emissions.....  | 423 |
| Figure 64. Houston to Beaumont Corridor - Potential Baseline Area.....   | 428 |
| Figure 65. Houston-Beaumont 10-Year Weighted AADT Trend (1996–2006).....   | 430 |
| Figure 66. Texas Counties Designated “Nonattainment” for Clean Air Act’s National Ambient Air Quality Standards (NAAQS).....             | 431 |
| Figure 67. Relative Size and Distance of Texas Population Centers along Project 0-5930 Study Corridors.....                              | 435 |
| Figure 68. Houston to Austin Corridor Population and Distance in 2000, 2008 Estimates, and Projected 2040 (Population in Thousands)..... | 438 |
| Figure 69. Houston to Austin Corridor Population and Distance in 2000, 2008 Estimates, and Projected 2040 (Population in Thousands)..... | 439 |
| Figure 70. Houston to Austin via US 290 10-Year Weighted AADT, 1997–2006.....  | 442 |
| Figure 71. Dallas to San Antonio Corridor Population Distribution (Population in Thousands).....   | 446 |
| Figure 72. Texas Population by County, 2040.....   | 448 |
| Figure 73. Amtrak Routes and Stations in Texas.....  | 450 |
| Figure 74. Dallas-Fort Worth to San Antonio 10-Year Weighted AADT Trend.....   | 453 |
| Figure 75. Intercity Bus Service in Texas.....   | 455 |

|  |     |
|--|-----|
| Figure 76. San Antonio to Brownsville via Laredo Corridor Map .....  | 459 |
| Figure 77. San Antonio to Brownsville via Laredo Corridor Population Distribution<br>(Population in Thousands) ..... | 460 |
| Figure 78. San Antonio to Brownsville via Laredo 10-Year Weighted AADT, 1997–<br>2006 .....                          | 463 |
| Figure 79. San Antonio to Brownsville via Corpus Christi .....   | 466 |
| Figure 80. San Antonio to Brownsville via Corpus Christi (Population in Thousands).....                              | 467 |
| Figure 81. San Antonio to Brownsville via Corpus Christi 10-Year Weighted AADT,<br>1997–2006 .....                   | 469 |
| Figure 82. Dallas-Fort Worth to Houston Corridor Population and Distance (Population<br>in Thousands).....           | 473 |
| Figure 83. Dallas-Fort Worth to Houston 10-Year Weighted AADT, 1997–2006. ....                                       | 476 |
| Figure 84. Houston to Waco Corridor Map .....  | 481 |
| Figure 85. Houston to Waco Corridor Population Distribution.....   | 482 |
| Figure 86. Corridor 16 – HOUWAC – 10-Year AADT .....   | 485 |

## LIST OF TABLES

|   | <b>Page</b> |
|---|-------------|
| Table 1. 2009 Focus Group Allocations. ....   | 2           |
| Table 2. Lufkin Focus Group Allocation Survey.....  | 14          |
| Table 3. Arlington Focus Group Allocation Survey.....   | 15          |
| Table 4. Amarillo Focus Group.....  | 31          |
| Table 5. Brownsville Focus Group.....   | 32          |
| Table 6. Brownwood Focus Group.....   | 33          |
| Table 7. El Paso Focus Group.....   | 34          |
| Table 8. Houston Focus Group.....   | 35          |
| Table 9. Killeen Focus Group.....   | 36          |
| Table 10. Focus Group Allocations for Each Region.....  | 38          |
| Table 11. Demographics of Focus Groups.....   | 42          |
| Table 12. Video Questionnaire Results.....  | 43          |
| Table 13. Prioritizing the Goals.....   | 64          |
| Table 14. Brownwood Focus Group Vote Results.....   | 77          |
| Table 15. Arlington Focus Group Vote Results.....   | 78          |
| Table 16. El Paso Focus Group Vote Results.....   | 78          |
| Table 17. Demographics of Focus Groups.....   | 93          |
| Table 18. Daily Traffic Volume per Lane and Speed Estimate Used in Delay Calculation.....                       | 129         |
| Table 19. Focus Group Session Distribution.....   | 137         |
| Table 20. Focus Group Session Distribution.....   | 140         |
| Table 21. Typical Chemical Compositions of Nonferrous Slag, (%). ....   | 341         |
| Table 22. Heavy Metal Concentrations Measured in ASARCO Slag Samples.....                                       | 342         |
| Table 23. Heavy Metal Leachate Concentrations Derived from ASARCO Slag Samples.....                             | 342         |
| Table 24. Typical Mechanical Properties of Nonferrous Slag (3).....   | 344         |
| Table 25. Statistical Summary of Stringer Forces.....   | 384         |
| Table 26. Port Aransas Ferry Operations with Existing and Modified Fleets (2-Hour<br>Analysis).....             | 413         |
| Table 27. Recycled Materials Strategies.....  | 420         |
| Table 28. Warm Mix Asphalt Strategies.....  | 421         |
| Table 29. Combined Strategies.....  | 421         |
| Table 30. Historic and Future Estimated Quantities (Tons).....  | 422         |
| Table 31. Carbon Dioxide Reductions.....  | 423         |
| Table 32. Carbon Dioxide Equivalencies.....   | 424         |
| Table 33. Corridor Population Distribution and Estimated Travel Times at Various<br>Average Speeds.....         | 429         |
| Table 34. Market Potential Elements from Project 0-5930.....  | 429         |
| Table 35. Selected Highway Travel Elements from Project 0-5930.....   | 430         |
| Table 36. Air Travel Demand for Corridor Houston-Beaumont from 1996 to 2008.....                                | 433         |
| Table 37. Houston to Austin CBSA Populations, Distances, and Estimated Travel Times.....                        | 436         |
| Table 38. Houston to Austin via College Station CBSA Populations, Distances, and<br>Estimated Travel Times..... | 437         |
| Table 39. Houston to Austin Demographic Data from TxDOT Project 0-5930.....                                     | 440         |
| Table 40. Air Travel Demand for Corridor Houston-Austin from 1996 to 2008.....                                  | 440         |

|   |     |
|---|-----|
| Table 41. Houston to Austin Highway Travel Patterns via US 290. ....  | 441 |
| Table 42. Freight Rail Segment Density and Rail Volumes. ....   | 444 |
| Table 43. Current and Future Levels-of-Service (Houston to Austin). ....  | 444 |
| Table 44. Dallas-Fort Worth to San Antonio CBSA Population, Distances, and Estimated<br>Travel Times. ....  | 447 |
| Table 45. Dallas-Fort Worth to San Antonio Demographics. ....   | 448 |
| Table 46. Gainesville CBSA Demographics. ....   | 449 |
| Table 47. Amtrak Texas Routes Ridership, FFY 2007–2009. ....  | 450 |
| Table 48. Corridor Amtrak Stations – Boardings and Alightings, FFY 2007–2009. ....  | 451 |
| Table 49. Five Largest Amtrak Intercity Passenger City-Pairs with at Least One Endpoint<br>in Texas for the Period September 2006–August 2007. .... | 451 |
| Table 50. Air Travel Demand for Corridor Dallas/Fort Worth – San Antonio from 1996<br>to 2008 (Not Including DFW-OKC). ....                         | 452 |
| Table 51. Dallas-Fort Worth to San Antonio Highway Travel Patterns. ....  | 453 |
| Table 52. Freight Rail Segment Ownership. ....  | 457 |
| Table 53. Segment Density and Rail Volumes (Dallas to San Antonio). ....  | 457 |
| Table 54. Current and Future Levels-of-Service (Dallas to San Antonio). ....  | 458 |
| Table 55. San Antonio to Brownsville via Laredo CBSA Population, Distances, and<br>Estimated Travel Times. ....                                     | 461 |
| Table 56. San Antonio to Brownsville via Laredo Demographics. ....  | 462 |
| Table 57. Air Travel Demand for Corridor San Antonio to Brownsville from 1996 to<br>2008. ....  | 462 |
| Table 58. San Antonio to Brownsville via Laredo Highway Travel Patterns. ....   | 464 |
| Table 59. Segment Density and Rail Volumes (San Antonio to Brownsville). ....   | 465 |
| Table 60. Current and Future Levels-of-Service (San Antonio to Brownsville). ....   | 465 |
| Table 61. San Antonio to Brownsville via Corpus Christi CBSA Population, Distances,<br>and Estimated Travel Times. ....                             | 468 |
| Table 62. San Antonio to Brownsville via Corpus Christi Demographics. ....  | 468 |
| Table 63. Air Travel Demand for Corridor from 1996 to 2008. ....  | 469 |
| Table 64. San Antonio to Brownsville via Corpus Christi Highway Travel Patterns. ....   | 470 |
| Table 65. Segment Density and Rail Volumes. ....  | 471 |
| Table 66. Current and Future Levels-of-Service (San Antonio to Brownsville). ....   | 472 |
| Table 67. Dallas-Fort Worth to Houston CBSA Population, Distances, and Estimated<br>Travel Times. ....  | 474 |
| Table 68. Dallas-Fort Worth to Houston Demographics. ....   | 474 |
| Table 69. Intrastate Passenger Air Service City-Pair Market Distance. ....  | 475 |
| Table 70. Air Travel Demand for Corridor Dallas/Fort Worth to Houston from 1996 to<br>2008. ....  | 475 |
| Table 71. Dallas-Fort Worth to Houston Highway Travel Patterns. ....  | 476 |
| Table 72. Freight Rail Lines Associated with Study Corridors – General Segment<br>Description. ....   | 478 |
| Table 73. Freight Rail Lines Associated with Study Corridors – Segment Density and<br>Volumes. ....   | 479 |
| Table 74. Freight Rail Lines Associated with Study Corridors – Current and Future<br>Levels-of-Service. ....  | 480 |

|  |     |
|--|-----|
| Table 75. Houston to Waco to Dallas-Fort Worth CBSA Population, Distances, and<br>Estimated Travel Times. .... | 483 |
| Table 76. Houston to Dallas via College Station and Waco Demographics. ....                                    | 484 |
| Table 77. Intrastate Passenger Air Service City-Pair Market Distance. ....                                     | 484 |
| Table 78. Air Travel Demand for Corridor Houston-Waco from 1996 to 2008. ....                                  | 485 |
| Table 79. Houston to Waco Highway Travel Patterns. ....  | 486 |
| Table 80. Segment Density and Rail Volumes (Houston to Waco). ....   | 487 |





# **WORK REQUEST FIVE: PHASE II FINAL REPORT: PUBLIC PERCEPTIONS REGARDING THE TEXAS DEPARTMENT OF TRANSPORTATION: FOCUS GROUP RESULTS**

## **EXECUTIVE SUMMARY**

Focus groups are an excellent method to delve into complicated issues and uncover what the public is thinking, why they think that, and how they react to additional information or alternative scenarios. The Texas Transportation Institute (TTI) conducted a series of focus groups in July and August 2009 in eight Texas cities designed to investigate issues relating to mobility, connectivity, pavement quality, funding, and general perceptions of Texas Department of Transportation (TxDOT) operations. The findings from the groups of 7 to 12 participants do not provide a statistical sample of public opinion.

The findings suggest several challenges for TxDOT in the topics of providing information about the condition, status, plans, and performance of the transportation system and the decision process for making investments to improve the system. They also indicate a general understanding that the Texas road system is better than that of nearby states and that the funding challenges are substantial. This executive summary identifies several themes from the focus groups and suggests some steps that should be considered to address the issues.

### **What They Said**

Almost every focus group participant misunderstood some element of how TxDOT is funded. When asked an open-ended question like “where does TxDOT get its funding?” few participants could identify even the basic funding sources—fuel taxes and vehicle registration fees—and even fewer knew that public schools are funded with fuel taxes. Participants also misunderstood other significant TxDOT funding issues such as funding diversions to other agencies or the general fund.

Focus group participants had a good understanding of TxDOT’s general role in the funding, creation, and maintenance of the street and highway network, and most understood that TxDOT had a small role in public transportation. About half of the participants could identify that TxDOT had responsibility for some major roads and the city or county was responsible for most minor roads. But specific knowledge about which roads are in which jurisdiction was found infrequently. Participants in most of the focus groups thought that TxDOT could be spending its funds more wisely, specifically mentioning the following:

- Long construction schedules mean a road is torn up, creating more congestion and travel difficulties for many years. Several construction stages covering only short sections of a corridor at a time were mentioned as harming motorists, truck routes, emergency services, and adjacent businesses.
- Many believed TxDOT was directly responsible for construction and expressed concern over construction workers standing idle or project work zones with no activity in them.

- Roads that had recently been finished were being resurfaced (e.g., seal coat treatments) sooner than required.
- Roads that were either inadequate when initially opened (e.g., not wide enough) or poorly designed were mentioned as causing doubt about TxDOT’s planning, design, and oversight program.

When the conversation turned to experience with roads in other states, participants thought that Texas had much better roads than neighboring states and in most cases better than any roads they had experienced in the United States. Texas’ smooth roads and good rest areas were noted by several travelers. Texas lagged behind in the perception of the extent and effectiveness of intercity and urban public transportation modes and services. Several of the groups perceived that the long-range transportation plans they knew about were mostly for roads and toll roads without enough planning for adapting to high gas prices, limited fuel, climate change policies, or larger numbers of older Texans who will be less able to drive.

After a brief explanation of the current transportation funding situation, participants were provided with information about the future outcomes of a set of options for allocating TxDOT funding to two broad categories: pavement maintenance and bridge quality versus urban mobility and rural connectivity. Current and future conditions were calibrated to each focus group location using data on current conditions and findings from the *2030 Committee Texas Transportation Needs Report*. Participants were given \$100 to allocate to each of the two categories, with outcome conditions described for each \$10 increment. In general the pavement descriptions were similar, though the metro and urban groups focused on reducing congestion and the rural group focused on improving rural connectivity. For all eight cities, the descriptions required that \$90 of the \$100 be allocated to the pavement and bridge category to maintain current conditions. The initial allocations were discussed among the group, and re-allocation was allowed, although only small changes were noted in most locations. Participants made a surprisingly large range of funding allocations, \$46 to \$82 for pavement and bridge issues, as noted in [Table 1](#). A simple average of the values indicates that in the present environment of limited funding, participants are willing to see lower-quality roads and more bridges with weight limits in exchange for additional lanes and roads in urban areas and more divided highways in rural areas.

**Table 1. 2009 Focus Group Allocations of \$100.**

| Region      | Pavement/Bridge<br>(Dollars) | Mobility/Connectivity<br>(Dollars) |
|-------------|------------------------------|------------------------------------|
| Overall     | 64                           | 36                                 |
| Amarillo    | 82                           | 18                                 |
| Arlington   | 46                           | 54                                 |
| Brownsville | 46                           | 54                                 |
| Brownwood   | 72                           | 28                                 |
| El Paso     | 55                           | 45                                 |
| Houston     | 70                           | 30                                 |
| Killeen     | 63                           | 37                                 |
| Lufkin      | 58                           | 42                                 |

Current funding was noted as a significant barrier to progress; participants generally agreed that their lack of current knowledge was a barrier to their support for funding increases. If they could be convinced that their tax dollars were being well spent and that any additional taxes would be well spent, the current system of vehicle registration and motor fuel taxes had the most support as the mechanism for increased funding. Tolls and vehicle travel fees had some support, but also met with more skepticism about how these new processes would be instituted and fear about the misuse of the information collected. The participants mentioned safety needs, even though there were no data available to identify the cost of those solutions.

When asked about a successful TxDOT, most participants identified solutions to the above problems and perceived inadequacies, but they also mentioned that one of their problems was with the lack of information about current and future activities. They appreciated the opportunity to talk to the researchers about TxDOT and wished there were more opportunities to discuss concerns. They also wondered why there was such a lack of knowledge about TxDOT within the group. Interestingly, a few participants noted that this might be a good goal for TxDOT (expressed as “success is when I don’t have to think about TxDOT or the roads – they just work”). But more often the issue was approached from the perspective of requesting more information about the agency, its performance, and current and future plans. Almost all participants said they left knowing more than when they began the focus group and looked forward to other opportunities to learn about transportation issues.

### **The Take-Aways and Some Possible Solutions**

The findings of the focus group discussion relate to two broad areas of potential future activity for TxDOT. There are several issues related to *activities* that will address perceived shortcomings or enhance areas of good practice or positive trends. There were also findings that point to *how and when* the messages might be conveyed.

#### *People Don’t Know Who You Are, What You Do, or How You Get Your Money*

This is the most significant and consistent finding in all eight focus groups. While the general activities of TxDOT are well understood, that knowledge is very thin, and in many cases the knowledge is just wrong. In some sense this is consistent with other technically oriented government agencies; the topics are complex, the issues numerous, and the outcomes relatively mundane. The idea that success means not thinking about transportation is both appealing if one likes “flying under the radar” and daunting for an agency attempting to persuade the public of the value of its services.

There must be a better education component to TxDOT’s program. Many taxpayers do not know the basic information needed to properly assess transportation’s role in society and the economy, and are even less equipped to properly judge TxDOT’s functions. It is difficult for an agency in this position to discuss the proper roles, expectations, vision, and funding sources or levels. The public must see the value they get for the limited funds available before the discussion can turn to what may be done with additional funding.

Across the United States, over the past decade constituents in several local and statewide elections have voted to increase funding, provide additional operating and funding flexibility, or develop new programs or projects (American Road and Transportation Builders Association [ARTBA] website: <http://www.artba.org/advocacy/government-affairs/transportations--elections/>).

A review of these elections suggests that the election results were successful because the voters perceived the agency as operating efficiently and effectively, saw the plan or program as providing good value for the expenditures, and saw the right amount of transparency and accountability in place to maintain the schedule and budget that were promised (with updates and changes as required by the projects).

The following message elements could help inform the public about some of the basic misunderstandings identified in the focus groups. These are basic information pieces rather than a campaign storyboard; the proper mix of message and target audiences was not the subject of this research effort:

- What does the public care about?
- Funding sources – where the money comes from.
- Spending categories – where the money goes.
- Funding trends – for recent past and near-term future revenues.
- Improvement trends – the Interstate-era spending in the 1960s and 1970s led to good conditions in the 1980s; now those roads have to be rebuilt, in addition to adding new capacity to handle growth.
- Status of projects, programs, and problems – building on the activities in Project Tracker, TxDOT’s web-based project tracking website.
- Current conditions – for all major TxDOT activities at the district, county, and state level.

The goal of these efforts is to be consistent and persistent. Erroneous understanding and misinformation cannot be addressed in a few weeks, and trust is built over time. Effective communication on the technical topics that make up the bulk of TxDOT’s program requires continuous interaction between the public and the technical information providers; complicated topics require more than sound bites. The information program must be a part of the commitment to transparency and accountability and should not be conducted only when there is a push for additional funding. Focus group participants were ready to be informed but appeared to be interested in a longer conversation about TxDOT’s needs. Building a base of public information will lead to public support if TxDOT is doing a good job and making the best decisions. This longer-range view has proven to be successful in the past and is more sustainable than a “momma wants new shoes” approach to providing public information only during funding increase campaigns.

### *A Few Logical Information Steps*

Project Tracker provides a good basis for the kind of information that the focus group participants expressed a desire for. Information about projects and programs is an important component of accountability and transparency. While Project Tracker was not reviewed in depth (and therefore we cannot draw any conclusions about the style, format, and organization of the website), the display and regular updating of key public information will be important in the future.

Focus group participants indicated they were interested in learning more about important transportation issues and TxDOT activities, but they did not think this education should be a product of 30-second television commercials (i.e., they did not want to be “sold” on TxDOT). This negative opinion of television commercials seemed to be a product of two issues—these are difficult concepts to communicate in a short time period and the conception that television commercials would be produced at a high public cost. With all of the free media channels open to an agency (e.g., Twitter, Facebook, and its own website), there should be enough methods to provide an interested public with facts, current conditions, and forecasts as well as to share information through surveys and study results. There may also be a role for viral or inexpensive information exchanges.

Building on reports and requirements from the Texas Legislature is another method for attracting attention to public interest issues. Project Tracker can be the “source for everything you want to know about TxDOT,” but content such as current weather and road conditions, traffic congestion maps, travel time information, the 100 most congested roads, pavement quality maps, and other elements may encourage visitors to look at other pages on the website. These can be the portals that attract citizens into the information streams in a way that short-time-period campaigns cannot accomplish.

## **FULL REPORT**

Focus groups are an effective means of evaluating general perceptions of various topics. Focus group-derived data allow for an in-depth exploration of thoughts and opinions related to a particular topic and demonstrate how those thoughts and opinions are communicated. Focus groups can provide a qualitative sample of public opinion that is particularly useful input as organizational changes are implemented.

TxDOT wished to develop an understanding of the current perceptions of the public about its agency, its functions and processes, and its plans for the future. A series of focus groups was conducted in July and August 2009 to assess the perceived strengths and weaknesses of TxDOT in a few significant topic areas. The output identified issues and priorities that were important to the public. The information gathered and described in this tech memo will be valuable input to TxDOT as new goals are developed and put forth. Moreover, the results can be used to formulate clear, articulate messages that resonate with the public.

The following eight focus group locations offered geographic diversity as well as representation from both urban and rural areas:

- Amarillo,
- Arlington,
- Brownsville,
- Brownwood,
- El Paso,
- Houston,
- Killeen, and

- Lufkin.

The focus group conversation concentrated on three main topics:

- General impressions of TxDOT, the transportation system in Texas, and what the public appreciates about the system.
- What actions and attributes would make TxDOT more successful, i.e., what success would look like for the department.
- A discussion of funding priorities, which required participants to allocate available funding to pavement and bridge maintenance, mobility, and rural connectivity. Information for each location was developed so that the input and resulting condition descriptions were meaningful to the participants. For example, comparisons of pavement conditions for well-known local roads and major highways were noted to provide a connection between the “real world” and 2007 pavement condition measurements. The participants also received information on the urban travel time reduction effects and the effect on intercity rural routes from added spending. The participants, thus, had examples of the effects of various funding allocations and projected outcomes, benefits, and relative costs.

Each focus group session lasted 2 hours with a free exchange of ideas, questions, and comments. The elements of the discussion are reviewed in the next several sections, with particular attention to what the participants said about current conditions and situations and what changes they might support.

### **Participant Recruitment**

Recruitment of participants in the eight cities selected for the focus groups varied greatly depending on the size of the city. For cities such as Houston, El Paso, and Arlington, the researchers had available to them a list of past survey respondents who indicated a desire to participate in future research. These cities also host offices of the Texas Transportation Institute in local office buildings, and researchers were able to post flyers within those buildings to recruit locally (Figure 1). These same cities, along with the Killeen-Temple metropolitan area, also have active Craigslist websites. Response to posting the flyer in the “gig: event” category on Craigslist in these cities was good, and in the case of Arlington the Craigslist users filled the session before contact was able to be made with the list of past participants. Although Amarillo and Brownsville have their own Craigslist websites, the response from these locations was less than expected. The remaining cities, Brownwood and Lufkin, do not have Craigslist websites dedicated to their specific cities but are included in the Abilene and Tyler/East Texas websites, respectively. Posting the flyer on these websites attracted few respondents. These two cities, along with Brownsville, had a much better response from the placement of the flyer as an advertisement in the local newspapers (Figure 2).

The use of other means of recruitment, specifically community calendars, contact with social organizations, and social media venues such as Facebook, was not effective, except in the case of Amarillo, when a TTI employee in College Station saw the request for contacts on Facebook and forwarded the contents of the flyer to former classmates in the area. One social club located in the Amarillo area also responded to the request to make the flyer available to its membership. The recruitment process for each city is detailed below.

## *Houston*

The recruiter contacted participants from past focus groups who had indicated interest in future focus groups and had provided email addresses. A flyer was also posted in the office building where the focus group session would be held and emailed to three social groups in the area. Seventeen individuals responded, filling the focus group and providing alternates should someone drop out.

Of the 17 participants, one was from the previous focus group participant list and at least four more were recruited by word of mouth from that person. Two others were recruited by word of mouth from TTI employees, and the rest responded to the flyer posted in the building.

WE WANT TO HEAR FROM YOU

Please Join  
Us for a

# FOCUS GROUP

5:30 P.M. to 7:30 P.M.  
Wednesday, August 5<sup>th</sup>, 2009  
Killeen Community Center  
2201 E. Veteran's Memorial Blvd.  
Killeen, TX 76543

The Texas Transportation Institute is seeking ten individuals to participate in a focus group session discussing the Texas Department of Transportation and priorities for transportation investment in Texas. Eligible participants should be regular drivers over 18. The focus group will take approximately two hours and participants will be paid \$ 50.00 for their time.

For more information or to register, interested individuals should contact:

Heather Ford at (512) 467-0946 or [h-ford@ttimail.tamu.edu](mailto:h-ford@ttimail.tamu.edu)

You must be registered to participate.



Figure 1. Sample Flyer Used for Recruitment in Targeted Locations.



Focus Group seeks 10 people to participate in a session discussing the Tx Dept. of Trans. & Transportation investment in Texas. Those eligible are regular drivers over 18. The group will take 2 hrs & participants will be paid \$ 50 for their time. For more info or to register contact Heather Ford 512-467-0944 or h-ford@ttimail.tamu.edu

**Figure 2. Flyer as It Appeared in the Newspaper Advertisements.**

*Killeen*

No past participant list was available for recruiting purposes. While seeking a location to hold the focus group, the recruiter also asked contacts if they would post the flyer. The Killeen YMCA agreed to post it at the front desk. At Mary Hardin-Baylor University, the student union was under renovation, but the contact there asked that we send the flyer anyway and he would circulate it among the approximately 50 students that were on campus for the summer. The recruiters also sent the flyer to Central Texas Community College to post in the student union and to local libraries in Killeen, Harker Heights, Belton, Temple, and Copperas Cove.

In addition, the contents of the flyer were posted to the Killeen-Temple Craigslist website and two online social organizations in the Killeen-Temple area. Of the individuals that registered, one person was recruited via the online social groups and three others by direct contact from the recruiter in the process of making posting requests. The remaining people were recruited via Craigslist, either directly or by word of mouth from the Craigslist participants.

*Amarillo*

No past participant list was available for this area. The recruiter requested that the flyer be posted at the location of the focus group session and at the other libraries in the city. The contents of the flyer were posted to the event category on the Amarillo Craigslist website, and a copy was sent to a local social club. After receiving little response the first week of recruitment, a post was made on the personal Facebook account of the recruiter, asking for friends with contacts in Amarillo to provide suggestions on additional locations in the area to post the flyer. One recruit volunteered to post the flyer in her place of employment, a health-care facility.

One member from the social club was recruited to participate, at least one other participant was recruited via a library flyer, one was recruited via word of mouth from a TTI employee in another division who saw the Facebook post, and the remaining people were recruited after the Craigslist ad was reposted under the “gig: event” category.

### *El Paso*

The recruiter contacted participants from past focus groups who had indicated interest in future focus groups and had provided email addresses. A flyer was also posted in the office building where the focus group session would be held and was emailed to a local social organization. The contents of the flyer were also posted to the El Paso Craigslist website. Four individuals responded from the past focus group participant list. The rest of the participants were recruited equally from the building flyer and the Craigslist posting.

### *Brownsville*

The recruiter requested that the flyer be posted at the local library as well as at the building hosting the focus group session. The contents of the flyer were electronically posted on the Brownsville Craigslist website and EventSetter.com website. After 2 weeks with very little response, a post for contacts in the Brownsville area was placed on the recruiter's personal Facebook page, hoping that more opportunities to post flyers would be found, and a TTI employee from another program sent a flyer to a relative that works at the University of Texas in Brownsville to post on campus. A final attempt to recruit participants was made by placing an abbreviated version of the flyer as an advertisement in the *Brownsville Herald* on August 12, 2009.

Three participants were recruited via the Craigslist posting. No participants were recruited via EventSetter.com, flyers, or Facebook contacts. The newspaper advertisement filled the remainder of the focus group slots and garnered several potential alternate attendees.

### *Brownwood*

No past participant list was available. Researchers requested that the flyer be posted at the local library. The flyer was electronically posted to the Abilene, Texas, Craigslist website, which covers the area of Texas between Abilene and San Angelo. Only two participants were recruited via Craigslist after 2 weeks of posting, so a newspaper ad was placed in the *Brownwood Bulletin*. The ad ran on Sunday, August 9, and Tuesday, August 11. All of the remaining participants were recruited through the newspaper advertisement.

### *Lufkin*

No past participant list was available. Researchers posted the contents of the flyer to the Tyler-East Texas Craigslist website and to the Lufkin Chamber of Commerce online calendar. The flyer was also sent to acquaintances in Lufkin for general distribution. Four participants were recruited from the Craigslist posting. An advertisement placed in the Sunday, August 23, edition of the *Lufkin Daily News* resulted in the recruitment of the remaining participants.

### *Arlington*

The focus group held at the TTI offices in Arlington on August 31 was recruited in its entirety from individuals who responded to the posting of the flyer on the local Craigslist website. In this instance, the recruiter had to actively screen out residents of counties other than Tarrant County since the ad resulted in an inundation of responses.

## Focus Group Discussion

### *Role of TxDOT*

In each focus group, there was confusion over what TxDOT does. Participants understood that TxDOT handles construction and maintenance of the roadway system in Texas. They were not always clear, however, about which roads fall under TxDOT's jurisdiction. Farm-to-market roads were confused with county and city roads. Additionally, mass transit services were often thought to be the responsibility of the department. When asked, participants guessed TxDOT responsibilities to include issuing driver's licenses, giving speeding tickets, installing fencing to keep deer from crossing the roads, and setting tax rates. This misunderstanding points to the need to educate the public about the role of the agency. Additional comments and notes from the focus groups can be found in [Appendix A](#).

### *Impressions of TxDOT*

Even though the responsibilities of TxDOT are not completely clear, participants had definite opinions about the job TxDOT is doing. Of highest profile are the construction projects. Each focus group conveyed some issues relating to projects taking too long, workers standing around, and travel delays associated with construction. Participants say that maintenance should be the highest priority. There is an overall sense that the agency is disorganized and wasteful.

The focus groups felt that congestion is worsening and TxDOT is not doing an adequate job planning for the future. As a Brownsville participant stated, "TxDOT should get the project done right the first time." Groups from several of the cities mentioned the need for better public transportation as an alternative approach to increased capacity projects. This sentiment is less apparent in the large metropolitan areas, where participants desired wider roadways with more lanes. Seeking more input from the public is preferred when making funding decisions and acquiring right-of-way.

It is not all bad, however. Some very positive comments were heard. One person in Lufkin stated that TxDOT is a very impressive organization. In both Amarillo and Brownwood, participants said that projects are being done quickly. In Killeen and elsewhere, people indicated that highways in Texas are better than in other states. In El Paso, half of the participants raised their hands when asked if TxDOT is doing a good job at roadway maintenance. Participants in large metropolitan cities like Houston reported good impressions: they are very happy with the finished I-10 project. Even Arlington and Brownsville groups shared a few positive remarks. Therefore, virtually every focus group indicated satisfaction with some aspect of the department.

### *What Success Looks Like*

Success means not having to worry about dying, as one person in Brownsville put it. The need for safe roads was heard across the state, and safety surfaced as a topic in various discussions surrounding pavement condition, rest areas, rumble strips, pavement markings, pedestrians, speed limits, nighttime illumination, landscaping, and trucks. Safe roads was quoted as the highest priority for measurement of success for TxDOT in focus groups across the state. Even though they could not use this priority in the funding allocation survey, they considered it when "spending" their \$100 in the funding exercise.

After safety, the next most frequently mentioned measure of success applied to maintenance. Successful maintenance, according to participants, includes smooth roads where debris is swept clean, structures are repaired quickly, traffic signs are clear, and potholes are fixed. One person in Arlington said, “On I-30 there was a pothole big enough to hurt a car. Some sort of hotline would be good.” More than one focus group brought up problems associated with large aggregate, as reports of broken windshields and uncomfortable rides were mentioned. Roadside mowing was proposed in Brownsville as a way to measure success. A Lufkin participant had a creative idea about using the roadside as a place to harvest grass.

Finally, planning for the future was stated as a measure of success. Participants want smooth-flowing traffic using available technology like warning systems that alert drivers of incidents. In El Paso, someone mentioned the way crashes were quickly moved off the highway in Las Vegas, Nevada, where he/she used to live. It does not happen as quickly in El Paso, resulting in congestion and frustration. Planning also means understanding where growth will occur and accommodating it appropriately. The oil shortage, global warming, and massive increases in gas prices need to be addressed by providing alternatives to driving alone. One Lufkin participant said that TxDOT should not be so interested in pouring concrete. Involving the public in these processes is also a part of good planning practices. Part of good planning practices means communicating with other local agencies. Several participants mentioned the need for more cooperation and coordination among agencies in planning for the future.

### *Allocation Scenarios*

The element of the focus groups that dealt with the funding allocation issue drew upon the findings of the *2030 Needs Report* and the current pavement condition rating surveys. Regional needs and current trends were combined into an information document that provided participants with realistic choices connected to expected outcomes based on current revenue trends. The pavement and mobility allocation surveys (described below) used in one metropolitan region and one rural area are illustrated in [Tables 2 and 3](#). Pavement and mobility allocation surveys for additional regions are found in [Tables 4–9](#) in [Appendix B](#).

- Pavement and bridge quality – While the *2030 Needs Report* analysis produced statewide pavement and bridge maintenance cost information, district-level condition studies conducted every year provided information to guide the preparation of the condition scenarios. In all eight regions, “keep pavement and bridge ratings where they are now” required 90 percent of the funding; this might be on the low end of the necessary percentage of spending depending on the amount and type of growth. All of the scenarios were phrased in similar ways. Bridge deterioration was described as resulting in load-limiting bridges (rather than “bridges falling down”) based on input from subject experts and a desire to keep pavement concerns separate from safety concerns. Examples of pavement condition rating were provided by referencing specific local road sections and using pictures of roads with pavement scores.
- Urban mobility and rural connectivity – Focus groups in larger population centers were presented with choices that described the effects on congestion resulting from a variety of investment levels. Rural and small area urban choices concentrated on investments resulting in wider and divided highways linking to larger towns or major routes.

The participants were informed about the general trend in vehicle registration fees and motor fuel tax receipts over the last 20 years to clear any misinformation on that topic. They were advised of their options and the need to spend only \$100, and were allowed 10 minutes to study the pictures and consider their choices. The participants made their choices individually for the most part, and the group was then asked to discuss their choices and allowed to re-prioritize their “spending” after hearing other participants’ thoughts; in most cases no changes were made.

Table 10 illustrates the final spending profiles for each focus group. While there was support for maintaining the current pavement and bridge system, the average of each focus group was below the 90 percent level of spending needed to maintain pavements in their current condition. No one suggested that maintenance of the current system is not important, and the authors recognize that pavement quality deterioration has a nonlinear effect on the cost to repair damage (i.e., it is much more costly to repair a road that is damaged than it is to keep a road from becoming damaged). But the allocation percentages show that in a time of limited funding, there may be public support for allowing minor roads to deteriorate if more divided highways can be constructed and travel times can be reduced.

**Table 2. Lufkin Focus Group Allocation Survey.**

| <b>Dollar Value</b> | <b>Pavement and Bridge Quality</b>   | <b>Dollar Value</b> | <b>Mobility and Connections to Other Cities</b>  |
|---------------------|--|---------------------|--|
| 0                   | None of the roads have “good” pavement quality. Average road is “poor” – like 1 <sup>st</sup> Street between Abney and Lufkin.   | 0                   | Current roads only   |
| 10                  | 10 percent of all roads have “good” or “very good” pavement quality. Average road is “poor” – like 1 <sup>st</sup> Street between Abney and Lufkin.  | 10                  | A few major four-lane roads that do not have a median are divided.   |
| 20                  | 20 percent of all roads have “good” or “very good” pavement quality. Average road is “poor” – like 1 <sup>st</sup> Street between Abney and Lufkin.  | 20                  | Half of the major four-lane roads that do not have a median are divided.   |
| 30                  | 30 percent of all roads have “good” or “very good” pavement quality. Average road is “fair” – like Raguet Street between Henderson and Thompson or Frank Avenue (SH 94) between Bynum and Herndon.             | 30                  | All major four-lane roads that do not have a median are divided.   |
| 40                  | 40 percent of all roads have “good” or “very good” pavement quality. Average road is “fair” – like Raguet Street between Henderson and Thompson or Frank Avenue (SH 94) between Bynum and Herndon.             | 40                  | All major and a few minor four-lane roads that do not have a median are divided.   |
| 50                  | 50 percent of all roads have “good” or “very good” pavement quality. Average road is “fair” – like Raguet Street between Henderson and Thompson or Frank Avenue (SH 94) between Bynum and Herndon.             | 50                  | All major and many minor four-lane roads that do not have a median are divided.  |
| 60                  | 60 percent of all roads have “good” or “very good” pavement quality. Average road is “fair” – like Raguet Street between Henderson and Thompson or Frank Avenue (SH 94) between Bynum and Herndon.             | 60                  | All major and most minor four-lane roads that do not have a median are divided.  |
| 70                  | 70 percent of all roads have “good” or “very good” pavement quality. Average road is “good” – like 1 <sup>st</sup> Street between Lufkin and Timberland.   | 70                  | All major and minor four-lane roads that do not have a median are divided.   |
| 80                  | 80 percent of all roads have “good” or “very good” pavement quality. Average road is “good” – like 1 <sup>st</sup> Street between Lufkin and Timberland.   | 80                  | All major and minor four-lane roads that do not have a median are divided. One major congested street is widened.  |
| 90                  | 88 percent of all roads have “good” or “very good” pavement quality. <b><i>This is close to the current condition.</i></b> Average road is “good” – like 1 <sup>st</sup> Street between Lufkin and Timberland. | 90                  | All major and minor four-lane roads that do not have a median are divided. A few major congested streets are widened.  |
| 100                 | 93 percent of all roads have “good” or “very good” pavement quality. Average road is “very good” – like John Redditt Drive (US 69) between Raguet Street and Frank Avenue (SH 94).                             | 100                 | All major and minor four-lane roads that do not have a median are divided. A few major congested streets are widened, and one major congested rural road is widened. |

**Table 3. Arlington Focus Group Allocation Survey.**

| Dollar Value | Pavement and Bridge Quality  | Dollar Value | Congestion  |
|--------------|--|--------------|---|
| 0            | None of the roads have “good” pavement quality. Average road is “poor” – like SH 360 Freeway between Park Row and Division Street or Pioneer Parkway between Center and Collins.                             | 0            | A trip that takes 25 minutes now will take 60 minutes; stop-and-go traffic on many roads and freeways for 8.5 hours each weekday. |
| 10           | 5 percent of all roads have “good” or “very good” pavement quality. Average road is “poor” – like SH 360 Freeway between Park Row and Division Street or Pioneer Parkway between Center and Collins.         | 10           | A trip that takes 25 minutes now will take 58 minutes; stop-and-go traffic on many roads and freeways for 8.5 hours each weekday. |
| 20           | 10 percent of all roads have “good” or “very good” pavement quality. Average road is “poor” – like SH 360 Freeway between Park Row and Division Street or Pioneer Parkway between Center and Collins.        | 20           | A trip that takes 25 minutes now will take 56 minutes; stop-and-go traffic on many roads and freeways for 8.5 hours each weekday. |
| 30           | 20 percent of all roads have “good” or “very good” pavement quality. Average road is “fair” – like Cooper Street between Park Row and Abrams.  | 30           | A trip that takes 25 minutes now will take 54 minutes; stop-and-go traffic on many roads and freeways for 8 hours each weekday.   |
| 40           | 30 percent of all roads have “good” or “very good” pavement quality. Average road is “fair” – like Cooper Street between Park Row and Abrams.  | 40           | A trip that takes 25 minutes now will take 52 minutes; stop-and-go traffic on many roads and freeways for 8 hours each weekday.   |
| 50           | 40 percent of all roads have “good” or “very good” pavement quality. Average road is “fair” – like Cooper Street between Park Row and Abrams.  | 50           | A trip that takes 25 minutes now will take 50 minutes; stop-and-go traffic on many roads and freeways for 7.5 hours each weekday. |
| 60           | 50 percent of all roads have “good” or “very good” pavement quality. Average road is “fair” – like Cooper Street between Park Row and Abrams.  | 60           | A trip that takes 25 minutes now will take 48 minutes; stop-and-go traffic on many roads and freeways for 7.5 hours each weekday. |
| 70           | 60 percent of all roads have “good” or “very good” pavement quality. Average road is “good” – like the SH 360 frontage roads north of I-30 Freeway.  | 70           | A trip that takes 25 minutes now will take 46 minutes; stop-and-go traffic on many roads and freeways for 7.5 hours each weekday. |
| 80           | 70 percent of all roads have “good” or “very good” pavement quality. Average road is “good” – like the SH 360 frontage roads north of I-30 Freeway.  | 80           | A trip that takes 25 minutes now will take 44 minutes; stop-and-go traffic on many roads and freeways for 7 hours each weekday.   |
| 90           | Three-fourths of all roads have “good” or “very good” pavement quality. <b><i>This is close to the current condition.</i></b> Average road is “good” – like the SH 360 frontage roads north of I-30 Freeway. | 90           | A trip that takes 25 minutes now will take 42 minutes; stop-and-go traffic on many roads and freeways for 7 hours each weekday.   |
| 100          | 85 percent of all roads have “good” or “very good” pavement quality. Average road is “very good” – like SH 360 Freeway south of I-20 Freeway.  | 100          | A trip that takes 25 minutes now will take 40 minutes; stop-and-go traffic on many roads and freeways for 7 hours each weekday.   |

## *Observations by Region Type*

No single summary of the findings is possible; each of the eight regions had interesting facets to the spending allocations, and the results were not easily summarized by “metropolitan” or “rural.” The categories below describe the set of choices provided to the participants. Participants in all groups recognized the need for additional funding and appeared to be open to an informed discussion about alternative sources and uses of funds. Most groups also included a discussion about the types of congestion solutions that would be deployed, with some support for public transportation in all eight groups. Focus group participants in the smaller regions indicated both an understanding of the transportation needs of large population centers and a willingness to discuss a reduction in funding for their region to address the “big city” needs. Additional comments from the focus groups are found in [Appendix D](#).

- **Large Metropolitan Regions:** The high pavement/bridge maintenance scores in Houston were due to two factors: the negative effects of potholes and rough pavement on safety and the relatively small gains in travel time that would be achieved for additional spending on mobility improvement. These participants accept congestion as a way of life, as one person said, “Congestion is like breathing. It is a fact of life. I grew up in traffic.” The Arlington group took the expected approach for a major region (and did not include safety in their maintenance thinking); participants favored mobility funding over pavement quality, despite the low 2007 pavement scores.
- **Small Metropolitan Regions:** Brownsville and El Paso illustrated similar choices, with comments focusing on the relatively good road conditions now and the need to improve urban congestion levels and major intercity routes.
- **Rural Regions:** The rural and small urban focus groups in Amarillo, Lufkin, Brownwood, and Killeen allocated more than half of their share of funding to maintaining smooth roads and bridges, but most of them saw the need to spend funds addressing connectivity problems.

## **Conclusions**

The focus group discussions identify several challenges for TxDOT as well as several opportunities. The general lack of understanding about TxDOT is accompanied by an interest in the primary topics and a positive outlook on TxDOT’s contribution to communities and the state. Participants lacked knowledge about topics such as information about the condition, status, plans, and performance of the transportation system. Very few participants could identify the major revenue sources, and most did not understand the decision process for making investments to improve the system. The focus groups indicated a general understanding that the Texas road system and rest areas are better than those in nearby states and that the funding challenges are substantial.

Almost every focus group participant misunderstood some element of how TxDOT is funded, and very few could identify the key revenue sources of the other activities that are funded from the motor fuels taxes (i.e., Department of Public Safety and public schools). Educating the public is an enormous challenge for any agency, but particularly for one with significant needs and a limited ability to raise its funds without approval of legislators and the public.



Focus group participants had a good understanding of TxDOT’s general role in funding, creating, and maintaining the street and highway network, and most understood that TxDOT had a small role in public transportation. About half of the participants could identify that TxDOT had responsibility for some major roads and the city or county was responsible for most minor roads. But there were also several items of “knowledge” that were incorrect and other topics where the participants felt TxDOT could be spending its funds more wisely. Texas lagged behind in the perception of the extent and effectiveness of intercity and urban public transportation modes and services. Several of the groups had the perception that the long-range transportation plans they knew about were mostly for roads and toll roads and there was not enough discussion about adapting to possible future challenges presented by high gas prices, limited fuel, climate change policies, or larger numbers of older Texans who will be less able to drive.

The funding allocation exercise helped the participants understand the challenges TxDOT faces. The groups settled on a surprisingly large range of allocation—from \$46 to \$82 (out of \$100 total) for pavement and bridge issues. With \$90 required to keep the roads in their current physical condition, the allocations indicate a willingness to accept some level of deterioration in exchange for additional roads that could reduce travel time and provide more divided rural highways. The discussion also pointed to the need for a safety needs analysis similar to the pavement, bridge, and mobility information in the *2030 Needs Report*. Current funding was noted as a significant barrier to progress, but there was general agreement among the participants that their lack of current knowledge was a barrier to their support for funding increases. If they could be convinced that their tax dollars were being well spent and that any additional taxes would be well spent, the current system of vehicle registration and motor fuel taxes had the most support as the mechanism for increased funding. Tolls and vehicle travel fees had some support, but also met with more skepticism about how these new processes would be instituted and fear about the misuse of the information collected.

When asked about a “successful” TxDOT, most participants identified solutions to the above problems and perceived inadequacies, but they also mentioned that success might be defined as “I don’t have to think about TxDOT or the roads – they just work.” Almost all participants said they left knowing more than when they began the focus group and looked forward to other opportunities to learn about transportation issues.

Demographics for the focus group participants are found in [Table 11](#) in [Appendix E](#).

## Recommendations

The most significant and consistent finding in all eight focus groups was that most Texans generally understand TxDOT’s operations, but that knowledge is very thin and in many cases wrong. In some sense this is consistent with other technically oriented government agencies; the topics are complex, the issues numerous, and the outcomes relatively mundane. The idea that success means not thinking about transportation is both *appealing* if one likes “flying under the radar” and *daunting* for an agency attempting to persuade the public of the value of its services.

- **There must be an education component to TxDOT’s program** – Many taxpayers do not know the basic information needed to properly assess transportation’s role in society and the economy, and are even less equipped to properly judge TxDOT’s functions. An agency in this position is hard pressed to have a discussion about the

proper roles, expectations, vision, and funding sources or levels. The public must see the value they get for the limited funds available before the discussion can turn to what may be done with additional funding. Focus group participants in the smaller regions indicated both an understanding of the transportation needs of large population centers and a willingness to discuss a reduction in funding for their region to address the “big city” needs.

- **Education must be followed by action** – Across the United States, over the past decade there have been several local and statewide elections to increase funding, provide additional operating and funding flexibility, or develop new programs or projects (<http://www.artba.org/advocacy/government-affairs/transportations--elections/>). A review of these elections suggests that the measures passed because the voters perceived the agency as operating efficiently and effectively, saw the plan or program as providing good value for the expenditures, and saw the appropriate amount of transparency and accountability in place to maintain the schedule and budget that were promised (with updates and changes as required by the projects). Such an approach puts pressure on the agency to perform well, to tell the public about successful and unsuccessful performance, and to develop plans that react to public needs.
- **A few basic message elements communicated persistently and consistently will help** – The ideas below are basic information pieces rather than a “campaign storyboard”; the proper mix of message and target audiences was not the subject of this research effort.
  - What does the public care about?
  - Funding sources – where the money comes from.
  - Spending categories – where the money goes.
  - Funding trends – for the recent past revenues and near-term future.
  - Improvement trends – the Interstate-era spending in the 1960s and 1970s led to good conditions in the 1980s; those roads have to be rebuilt, in addition to adding new capacity to handle growth.
  - Status of projects, programs and problems – building on the activities in Project Tracker.
  - Current conditions – for all major TxDOT activities at the district, county and state level.

Effective communication on the technical topics that make up the bulk of TxDOT’s program requires continuous interaction between the public and the technical information providers; complicated topics require more than sound bites. The information program must be a part of the commitment to transparency and accountability and should not be conducted only when there is a push for additional funding. Focus group participants were ready to be informed but appeared to be interested in a longer conversation about TxDOT’s needs. Project Tracker is a good example of the kind of information for which focus group participants expressed a desire.

Focus group participants indicated they were interested in learning more about important transportation issues and TxDOT activities, but they did not think this education should be a

product of 30-second television commercials (i.e., they did not want to be “sold” on TxDOT). This seemed to be a product of two issues—the fact that these are difficult concepts to convey in short time periods, and television commercials would be produced at a high public cost. With all of the free media channels open to an agency (e.g., Twitter, Facebook, and its own website), there should be enough methods to provide an interested public with facts, current conditions and forecasts as well as to share information through surveys and study results. There may also be a role for viral or inexpensive information exchanges.

Building on reports and requirements from the Texas Legislature is another method for attracting attention to public interest issues. Project Tracker can be the “source for everything you want to know about TxDOT,” but content such as current weather and road conditions, traffic congestion maps, travel time information, the 100 most congested roads, pavement quality maps, and other elements may encourage visitors to look at other pages on the website. These can be the portals that pull citizens into the information streams in a way that short-time-period campaigns cannot accomplish.

## **REFERENCE**

*2030 Committee Texas Transportation Needs Report*



## **APPENDIX A: SUMMARY OF NOTES BY FOCUS GROUP**

### **Amarillo**

Seven participants were female, and three were male. Two were students, six were employed, and two were unemployed.

Impressions of TxDOT:

- TxDOT is responsible for road construction and associated delays, roadway maintenance, expansion projects, planning and street signs.
- Participants also list responsibilities that belong to other agencies: issue driver's licenses, perform red light enforcement, issue speeding tickets and set tax rates.
- Need to educate the public about the role of the agency.
- The freeway congestion is getting worse; much delay due to construction projects.
- Maintenance should be the highest priority since repairs are not being done quickly enough, though one participant was surprised by quickness of project completion.
- Focus on inspecting and repairing overpasses.
- Debris removal is not occurring.

Success Looks Like:

- Traffic flowing smoothly; TxDOT does a good job timing signals.
- Seek input from the public on funding decisions; more needed.
- Success is not having to think about it; TxDOT has done a good job in this regard.
- Better planning needed because Amarillo is becoming congested.
- Safe roads should be a priority.
- There is not a big difference in roadways in Texas as compared to New Mexico and Oklahoma.
- Nine participants say TxDOT is successful, while one says maybe.

The Funding Game:

- One participant knew that TxDOT is funded through the gas tax.
- One participant said that tying fuel consumption to revenue generation is a problem because people are encouraged to consume less fuel; this same participant said that increasing the vehicle registration fee might be a better way to bring in revenue.
- None are aware of the diversions of the gas tax to the Department of Public Safety or education; mixed responses on whether funding education from the gas tax is a good idea.
- Need to educate the public on how transportation in the state is funded.

- All of the participants placed a higher priority on pavement and bridge quality, with most putting 70 percent of their money there over connecting to other cities.

#### The Future:

- Participants generally agree that toll roads are a good way to make money; equity issues surrounding toll roads were mentioned by several participants.
- Two participants said they would not support a tax increase, while four agree to an incremental approach of raising gas taxes, with a set maximum.
- When asked about paying fees based on mileage, all participants said they do not support such a concept; the fuel tax is effectively “hidden,” so drivers are unaware they are being charged, while mileage-based fees are not hidden, so the public would attempt to bypass the fee.
- Rest areas are getting too big; all that is needed is a bathroom and water fountain.
- Dislike automated speed enforcement.
- People here drive larger vehicles for safety and do not intend to buy a hybrid.
- Participants agree that roadways will deteriorate if funding is not increased.

#### Arlington

Four females and three males participated. Most have lived in the area for more than 10 years. All are employed, but all mentioned the need for the extra money for participating in the focus group.

#### Impressions of TxDOT:

- Waste money.
- TxDOT does a fairly decent job (give them a C+ or B-).
- They do a quick fix and perform shoddy work on repairing potholes.
- Not doing a good job handling growth; by the time projects are done, they are already outdated.
- In construction zones, many people are not working.
- Construction projects take too long.

#### Success Looks Like:

- Better roads.
- Safety – repairing the roads.
- Roadway expansion; more lanes and wider roadways.
- Bridge maintenance.
- Priority should be on maintenance, not on making things pretty; another disagrees; nice trees and landscaping stimulates senses, so more likely to stay awake; trees in median block headlight glare; safety concern with trees in median, though.

- Good lighting along the highway.

#### The Funding Game:

- No one knows how TxDOT is funded.
- Three of the seven place higher priority on pavement quality, while two put priority on mobility and congestion, and two gave 50/50 split.
- Should not send our tax dollars to other states.
- Increase sin tax and take a percentage for transportation.
- Recognize that TxDOT does need help.
- Not opposed to gas tax increase as long as they have assurance that things will get done.
- Skeptical about giving more money to the government.
- Most are interested in the “pay as you go” alternative to the gas tax; would like to see more information.

#### The Future:

- The system will look much like it does today 20 years from now.
- In favor of wider and more lanes.
- Rest areas are important, and there are not enough of them.
- Call boxes are good where there is no cell phone coverage.
- Concerned with privacy issues; do not want to be tracked.

#### **Brownsville**

Six males and four females participated. Nine of the 10 participants are lifelong residents of the area. Two are disabled, two are students, and five are employed full time.

#### Impressions of TxDOT:

- Construction projects take too long and, once finished, begin again.
- Responsibilities include maintaining highways, frontage roads and farm roads.
- Farm roads are very dangerous.
- Need better coordination between schools and TxDOT; schools built on two-lane farm-to-market roads bring more traffic and increased crashes.
- Should get the project done right the first time.
- They do not plan for the future; it used to take 15 minutes to get to work, and now it is 35 minutes.
- We do not know what is going on; more education and communication needed.

#### Success Looks Like:

- Smooth traffic and clear signs and markings.

- Need call boxes for emergencies; many people do not have cell phones.
- Too many signs distract drivers.
- Slower vehicles for safer crossing by foot.
- Better safety for pedestrians and motorists; should study high crash locations and fix the problem.
- Success means not having to worry about dying.
- Need rail from San Antonio to Brownsville.
- Trucks should be restricted to designated highways or at least truck restriction lanes.
- Nice rest areas should be built in this area.
- TxDOT is doing okay moving along with the generation, but there is room for improvement.
- Better communication with the public.
- Better maintenance of roadways, like mowing, debris sweeping and pothole repair.
- Need more people to get the job done.

#### The Funding Game:

- Three of the 10 gave equal parts to maintenance and mobility, three gave more to maintenance, and four gave more to mobility.

#### The Future:

- All recognize that more money is needed.
- Mixed review on toll roads.
- Flat gas tax fee should be a percentage.
- Should not be any diversion of funds.
- Three say to raise the gas tax, three say not to raise the gas tax, and one says maybe; needs to know how much increase would be necessary to make a big difference.
- Need more public transportation.
- Do not like vehicle registration fee.

#### **Brownwood**

Six females and four males participated. Four of the participants have lived in the area for more than 20 years. Five have lived in the area for 5–8 years, and one moved here 3 years ago. Three are unemployed.

#### Impressions of TxDOT:

- Help stranded motorists.
- Repair the streets.



- Ride around in the truck all day.
- Construction takes a long time.
- Workers sitting around.

#### Success Looks Like:

- Get projects done quickly.
- Safety is a priority; likes rumble strips.
- Better planning for work force needs.
- Nighttime safety.
- Focus on one project at a time.
- Use materials that last, and make sure they work.

#### The Funding Game:

- No one knows how TxDOT is funded.
- All participants put their money toward maintenance with most using a 70/30 split.
- Agree that more money is needed, but gas prices are high enough.
- Could increase registration fees.
- Bring in other revenue sources like casinos, alcohol tax or something fun that also helps the government.
- Public does not feel the gas tax as much; could have a small increase.
- Have donations help fund TxDOT.

#### The Future:

- More public transportation in Brownwood.
- The future will see many more people in this area.
- Everybody needs money; hard to not make people mad.
- Develop a TxDOT lottery.

#### **El Paso**

Four females and seven males participated. All participants have lived here all their lives or longer than 25 years. All are employed.

#### Impressions of TxDOT:

- Disorganized.
- Construction workers not working.
- Bottleneck problems on I-10 not being addressed, even though participant called on numerous occasions.

- Highways look better in other cities around the state.

#### Success Looks Like:

- Pass-through financing for the inner loop (Spur 61) was a success.
- The loop and highways are good, but more markings and more lights needed.
- Monorail system would be good.
- Should not completely shut down roadways due to crashes; better warning system needed.
- Better coordination between law enforcement and TxDOT needed.
- Would like to see high-occupancy vehicle (HOV) lanes, dynamic traffic warning signs and improved entrance/exit ramps.
- Should focus on repairs (example: complete the loop construction) and better communication with other agencies as well as better utilization of technology for providing information.
- Ramp metering would be helpful here.
- Need wider roads.
- Information is needed on what the various agencies do like the metropolitan planning organization (MPO), TxDOT, etc.
- To solve the bickering that occurs at the local level, TxDOT should serve as the leader in transportation.

#### The Funding Game:

- On the whole, participants do not know how transportation is funded.
- TxDOT should increase the vehicle registration fees to help fund transportation.
- No participants are aware that a portion of the gas tax goes to fund education.
- Six of the participants are in favor of raising fuel taxes; one said that fuel tax is already too high.
- Transportation should be a priority in the state.
- If TxDOT were run more efficiently and effectively, the public would be more open to raising taxes.
- Half of the participants said that TxDOT is doing a good job at roadway maintenance.
- Six of the 10 participants placed a higher priority on maintaining pavement and bridges, while the remaining four put more money toward mobility.

#### The Future:

- Reduce truck traffic by being more self-sufficient in terms of producing goods locally; others say this approach is not possible, so TxDOT should focus on intercity mobility.
- Six say they will buy a hybrid vehicle in the future.

- Most agree with replacing the fuel tax with a fee based on miles driven.
- Four say it is fine for TxDOT to spend money on advertising what the agency does.

### Houston

There were seven females and four males. Ten are employed, and one is a student.

#### Impressions of TxDOT:

- Right-of-way needs are huge; wants to be able to provide input before government takes land.
- Hurricane evacuation – should have had a better plan; contra flow should have started sooner.
- Since project is complete, I-10 is great now.
- Toll road discussion – likes the EZ Pass but wants to have option to pay with cash too.
- HOV lanes confusing – fear of getting lost.
- Need better public education.

#### Success Looks Like:

- Free-flowing traffic is success – example I-10 but took too long to update highway; US 290 needs updating but no money left after I-10.
- Better planning (bad example is Sugar Land).
- Maintenance.
- Mass transit.
- Safety – should be number one priority (rumble strips, big pavement symbols and No Truck lanes).

#### The Funding Game:

- Most participants put more dollars on the maintenance side rather than the congestion side.
- Takes more dollars to effectively address congestion, so put most dollars on addressing maintenance.
- Sees maintenance as a safety issue.

#### The Future:

- More mass transit (rail on US 290 needed).
- TxDOT should fix congestion, but make sure roads are good quality.
- Funding solutions – fines on speeding, tax the hybrids and emissions tests.
- More toll roads and pay for use.
- Increase gas tax.

- Need to make roads safe.

### **Killeen**

Five participants were female, and four were male. Most have lived in the area for less than 3 years. There were three students, three were unemployed, one retired, and two were employed.

#### Impressions of TxDOT:

- Construction projects take too long.
- Mass transit lacking in Killeen.
- Good roads in Texas.
- Toll roads need to have cash option.
- Need more overpasses to make U-turns (do not like one-way frontage roads).
- Should consider options other than increased capacity.
- Need smoother roads.
- Better coordination needed between agencies (transit, TxDOT, etc.).

#### Success Looks Like:

- Construction projects done quickly.
- Maintenance of roads.
- Education about who they are.
- Safety in terms of the condition of the road.
- Create alternatives to big cars.
- Nice rest areas.

#### The Funding Game:

- Six participants put more dollars on maintenance, two put more on congestion/connectivity, one split money evenly, and the last did not understand.
- People want everything for nothing.
- Increase the vehicle registration fee (one-time fee).
- Weight of vehicle and number of miles should be factors into how much user spends.

#### The Future:

- Pay at the pump instead of through invoice.
- Do not want to pay for number of miles used.
- Toll roads get mixed reviews here.
- Raise gas prices, and then people would drive less and would ride mass transit.

- Do not do a fixed price gas tax; instead, base it on a percentage.
- Educate us through public service announcements.

### **Lufkin**

Six females and four males participated. Most have lived in the area for more than 10 years, and most are employed.

#### Impressions of TxDOT:

- Road maintenance sometimes not needed.
- Impressive organization, but also a big bureaucracy; controlled by governor.
- Very good roads as compared to Louisiana.
- Not planning for big changes, like when gas is \$20/gallon; need to plan for transit instead of only being interested in pouring concrete.
- Too many people watching people work.
- Construction has made a mess of the intersection at the loop near the mall.

#### Success Looks Like:

- Nice highways, good safety and good signs.
- Mass transit – partner with the city.
- Need alternatives to driving on the road.
- Bad seal coat job near Lufkin High School – rocks coming up too soon.
- No consistency in pavement material quality.
- Use the right-of-way for good; harvest the grass and hay; cut less often.

#### The Funding Game:

- No one knows how TxDOT is funded.
- Six people put higher priority on maintenance with most using a 60/40 split; three put equal priority on maintenance and mobility; one put higher priority on mobility.
- Roads are designed to travel too fast.

#### The Future:

- More mass transit.
- Train to big cities.
- No new highways needed; use roads differently.
- More dedicated lanes for slower traffic like bicycle lanes.
- Cars will be smaller.
- Dedicated truck lanes on the rural roads.

- Need to manage what funds we do have instead of asking for more.
- Place a higher tax on big fuel consumers.
- Instead of hiring out work, have TxDOT build and maintain roadways.
- TxDOT should be more open with decisions and get more people's opinions.
- We spread out because gas is cheap.
- Most do not like mileage fees; driving is a necessity, not a recreational activity.
- Have vehicle registration fee based on fuel efficiency.
- Wary of getting more money for TxDOT; needs transparency and oversight.
- Needs to educate but not with commercials; use the web or newspaper.

## APPENDIX B: ALLOCATION SURVEYS

**Table 4. Amarillo Focus Group.**

| <b>Dollar Value</b> | <b>Pavement and Bridge Quality</b>  | <b>Dollar Value</b> | <b>Mobility and Connections to Other Cities</b>  |
|---------------------|---|---------------------|--|
| 0                   | None of the roads have “good” pavement quality. Average road is “poor” – like Amarillo Boulevard between Hughes Street and Taylor Street.   | 0                   | Current roads only.  |
| 10                  | 10 percent of all roads have “good” or “very good” pavement quality. Average road is “poor” – like Amarillo Boulevard between Hughes Street and Taylor Street.  | 10                  | A few major four-lane roads that do not have a median are divided.   |
| 20                  | 20 percent of all roads have “good” or “very good” pavement quality. Average road is “poor” – like Amarillo Boulevard between Hughes Street and Taylor Street.  | 20                  | Half of the major four-lane roads that do not have a median are divided.   |
| 30                  | 30 percent of all roads have “good” or “very good” pavement quality. Average road is “fair” – like Amarillo Boulevard between Western Street and McMasters Street.                                    | 30                  | All major four-lane roads that do not have a median are divided.   |
| 40                  | 40 percent of all roads have “good” or “very good” pavement quality. Average road is “fair” – like Amarillo Boulevard between Western Street and McMasters Street.                                    | 40                  | All major and a few minor four-lane roads that do not have a median are divided.   |
| 50                  | 50 percent of all roads have “good” or “very good” pavement quality. Average road is “fair” – like Amarillo Boulevard between Western Street and McMasters Street.                                    | 50                  | All major and many minor four-lane roads that do not have a median are divided.  |
| 60                  | 60 percent of all roads have “good” or “very good” pavement quality. Average road is “fair” – like Amarillo Boulevard between Western Street and McMasters Street.                                    | 60                  | All major and most minor four-lane roads that do not have a median are divided.  |
| 70                  | 70 percent of all roads have “good” or “very good” pavement quality. Average road is “good” – like I-40 between South Grand Street and Eastern Street.  | 70                  | All major and minor four-lane roads that do not have a median are divided.   |
| 80                  | Three-fourths of all roads have “good” or “very good” pavement quality. Average road is “good” – like I-40 between South Grand Street and Eastern Street.   | 80                  | All major and minor four-lane roads that do not have a median are divided. One major congested street is widened.  |
| 90                  | 83 percent of all roads have “good” or “very good” pavement quality. <i>This is close to the current condition.</i> Average road is “good” – like I-40 between South Grand Street and Eastern Street. | 90                  | All major and minor four-lane roads that do not have a median are divided. A few major congested streets are widened.  |
| 100                 | 90 percent of all roads have “good” or “very good” pavement quality. Average road is “very good” – like I-40 between West Loop 335 and South Tyler Street.  | 100                 | All major and minor four-lane roads that do not have a median are divided. A few major congested streets are widened, and one major congested rural road is widened. |

**Table 5. Brownsville Focus Group.**

| <b>Dollar Value</b> | <b>Pavement and Bridge Quality</b>   | <b>Dollar Value</b> | <b>Mobility and Connections to Other Cities</b>   |
|---------------------|--|---------------------|---|
| 0                   | None of the roads have “good” pavement quality. Average road is “very poor” – like Elizabeth and Washington Streets between Palm and International Boulevard.  | 0                   | A trip that takes 22 minutes now will take 40 minutes; stop-and-go traffic on many roads and freeways for 6 hours each weekday.   |
| 10                  | 10 percent of all roads have “good” or “very good” pavement quality. Average road is “poor” – like Boca Chica Boulevard near US 77.  | 10                  | A trip that takes 22 minutes now will take 39 minutes; stop-and-go traffic on many roads and freeways for 6 hours each weekday.   |
| 20                  | 20 percent of all roads have “good” or “very good” pavement quality. Average road is “poor” – like Boca Chica Boulevard near US 77.  | 20                  | A trip that takes 22 minutes now will take 38 minutes; stop-and-go traffic on many roads and freeways for 5.5 hours each weekday. |
| 30                  | 30 percent of all roads have “good” or “very good” pavement quality. Average road is “fair” –like Military Highway (US 281) between Camino del Rey and Russell Drive.  | 30                  | A trip that takes 22 minutes now will take 37 minutes; stop-and-go traffic on many roads and freeways for 5.5 hours each weekday. |
| 40                  | 40 percent of all roads have “good” or “very good” pavement quality. Average road is “fair” – like Military Highway (US 281) between Camino del Rey and Russell Drive.   | 40                  | A trip that takes 22 minutes now will take 36 minutes; stop-and-go traffic on many roads and freeways for 5 hours each weekday.   |
| 50                  | 50 percent of all roads have “good” or “very good” pavement quality. Average road is “fair” – like Military Highway (US 281) between Camino del Rey and Russell Drive.   | 50                  | A trip that takes 22 minutes now will take 35 minutes; stop-and-go traffic on many roads and freeways for 5 hours each weekday.   |
| 60                  | 60 percent of all roads have “good” or “very good” pavement quality. Average road is “fair” – like Military Highway (US 281) between Camino del Rey and Russell Drive.   | 60                  | A trip that takes 22 minutes now will take 34 minutes; stop-and-go traffic on many roads and freeways for 5 hours each weekday.   |
| 70                  | 70 percent of all roads have “good” or “very good” pavement quality. Average road is “good” – like Military Highway (US 281) between Alton Gloor Boulevard (FM 3248) and Camino del Rey.   | 70                  | A trip that takes 22 minutes now will take 33 minutes; stop-and-go traffic on many roads and freeways for 4.5 hours each weekday. |
| 80                  | Three-fourths of all roads have “good” or “very good” pavement quality. Average road is “good” – like Military Highway (US 281) between Alton Gloor Boulevard (FM 3248) and Camino del Rey.  | 80                  | A trip that takes 22 minutes now will take 32 minutes; stop-and-go traffic on many roads and freeways for 4.5 hours each weekday. |
| 90                  | 83 percent of all roads have “good” or “very good” pavement quality. <b><i>This is close to the current condition.</i></b> Average road is “good” – like Military Highway (US 281) between Alton Gloor Boulevard (FM 3248) and Camino del Rey. | 90                  | A trip that takes 22 minutes now will take 31 minutes; stop-and-go traffic on many roads and freeways for 4 hours each weekday.   |
| 100                 | 90 percent of all roads have “good” or “very good” pavement quality. Average road is “very good” – like US 77 Freeway between Morrison and East 18 <sup>th</sup> Street.   | 100                 | A trip that takes 22 minutes now will take 30 minutes; stop-and-go traffic on many roads and freeways for 4 hours each weekday.   |



**Table 6. Brownwood Focus Group.**

| <b>Dollar Value</b> | <b>Pavement and Bridge Quality</b>  | <b>Dollar Value</b> | <b>Mobility and Connections to Other Cities</b>  |
|---------------------|---|---------------------|--|
| 0                   | None of the roads have “good” pavement quality. Average road is “poor” – like Austin Avenue between Melwood Avenue and Brady Avenue.  | 0                   | Current roads only.  |
| 10                  | 15 percent of all roads have “good” or “very good” pavement quality. Average road is “poor” – like Austin Avenue between Melwood Avenue and Brady Avenue.   | 10                  | A few major four-lane roads that do not have a median are divided.   |
| 20                  | 25 percent of all roads have “good” or “very good” pavement quality. Average road is “poor” – like Austin Avenue between Melwood Avenue and Brady Avenue.   | 20                  | Half of the major four-lane roads that do not have a median are divided.   |
| 30                  | 35 percent of all roads have “good” or “very good” pavement quality. Average road is “fair” – like Main Avenue between Austin Avenue and Commerce Street.   | 30                  | All major four-lane roads that do not have a median are divided.   |
| 40                  | 45 percent of all roads have “good” or “very good” pavement quality. Average road is “fair” – like Main Avenue between Austin Avenue and Commerce Street.   | 40                  | All major and a few minor four-lane roads that do not have a median are divided.   |
| 50                  | 55 percent of all roads have “good” or “very good” pavement quality. Average road is “fair” – like Main Avenue between Austin Avenue and Commerce Street.   | 50                  | All major and many minor four-lane roads that do not have a median are divided.  |
| 60                  | 65 percent of all roads have “good” or “very good” pavement quality. Average road is “fair” – like Main Avenue between Austin Avenue and Commerce Street.   | 60                  | All major and most minor four-lane roads that do not have a median are divided.  |
| 70                  | 75 percent of all roads have “good” or “very good” pavement quality. Average road is “good” – like Austin Avenue between Brady Avenue and Parkway Street.   | 70                  | All major and minor four-lane roads that do not have a median are divided.   |
| 80                  | 80 percent of all roads have “good” or “very good” pavement quality. Average road is “good” – like Austin Avenue between Brady Avenue and Parkway Street.   | 80                  | All major and minor four-lane roads that do not have a median are divided. One major congested street is widened.  |
| 90                  | 88 percent of all roads have “good” or “very good” pavement quality. <b><i>This is close to the current condition.</i></b> Average road is “good” – like Austin Avenue between Brady Avenue and Parkway Street. | 90                  | All major and minor four-lane roads that do not have a median are divided. A few major congested streets are widened.  |
| 100                 | 95 percent of all roads have “good” or “very good” pavement quality. Average road is “very good” – like US 183 between County Road 368 and Early Boulevard.   | 100                 | All major and minor four-lane roads that do not have a median are divided. A few major congested streets are widened, and one major congested rural road is widened. |

**Table 7. El Paso Focus Group.**

| <b>Dollar Value</b> | <b>Pavement and Bridge Quality</b>   | <b>Dollar Value</b> | <b>Mobility and Connections to Other Cities</b>   |
|---------------------|--|---------------------|---|
| 0                   | None of the roads have “good” pavement quality. Average road is “poor” – like Paisano between Corona and Chamizal Memorial.  | 0                   | A trip that takes 22 minutes now will take 40 minutes; stop-and-go traffic on many roads and freeways for 6 hours each weekday.   |
| 10                  | 10 percent of all roads have “good” or “very good” pavement quality. Average road is “poor” – like Paisano between Corona and Chamizal Memorial.   | 10                  | A trip that takes 22 minutes now will take 39 minutes; stop-and-go traffic on many roads and freeways for 6 hours each weekday.   |
| 20                  | 20 percent of all roads have “good” or “very good” pavement quality. Average road is “poor” – like Paisano between Corona and Chamizal Memorial.   | 20                  | A trip that takes 22 minutes now will take 38 minutes; stop-and-go traffic on many roads and freeways for 5.5 hours each weekday. |
| 30                  | 30 percent of all roads have “good” or “very good” pavement quality. Average road is “fair” – like I-10 between Copia and US 54 Patriot Freeway.   | 30                  | A trip that takes 22 minutes now will take 37 minutes; stop-and-go traffic on many roads and freeways for 5.5 hours each weekday. |
| 40                  | 40 percent of all roads have “good” or “very good” pavement quality. Average road is “fair” – like I-10 between Copia and US 54 Patriot Freeway.   | 40                  | A trip that takes 22 minutes now will take 36 minutes; stop-and-go traffic on many roads and freeways for 5 hours each weekday.   |
| 50                  | 50 percent of all roads have “good” or “very good” pavement quality. Average road is “fair” – like I-10 between Copia and US 54 Patriot Freeway.   | 50                  | A trip that takes 22 minutes now will take 35 minutes; stop-and-go traffic on many roads and freeways for 5 hours each weekday.   |
| 60                  | 60 percent of all roads have “good” or “very good” pavement quality. Average road is “fair” – like I-10 between Copia and US 54 Patriot Freeway.   | 60                  | A trip that takes 22 minutes now will take 34 minutes; stop-and-go traffic on many roads and freeways for 5 hours each weekday.   |
| 70                  | 70 percent of all roads have “good” or “very good” pavement quality. Average road is “good” – like Paisano between Stanton and Cotton.   | 70                  | A trip that takes 22 minutes now will take 33 minutes; stop-and-go traffic on many roads and freeways for 4.5 hours each weekday. |
| 80                  | Three-fourths of all roads have “good” or “very good” pavement quality. Average road is “good” – like Paisano between Stanton and Cotton.  | 80                  | A trip that takes 22 minutes now will take 32 minutes; stop-and-go traffic on many roads and freeways for 4.5 hours each weekday. |
| 90                  | 83 percent of all roads have “good” or “very good” pavement quality. <b><i>This is close to the current condition.</i></b> Average road is “good” – like Paisano between Stanton and Cotton. | 90                  | A trip that takes 22 minutes now will take 31 minutes; stop-and-go traffic on many roads and freeways for 4 hours each weekday.   |
| 100                 | 90 percent of all roads have “good” or “very good” pavement quality. Average road is “very good” – like I-10 from US 54 Patriot Freeway to Paisano.  | 100                 | A trip that takes 22 minutes now will take 30 minutes; stop-and-go traffic on many roads and freeways for 4 hours each weekday.   |

**Table 8. Houston Focus Group.**

| <b>Dollar Value</b> | <b>Pavement and Bridge Quality</b>   | <b>Congestion</b>   |
|---------------------|--|---|
| 0                   | None of the roads have “good” or “very good” pavement quality. Average road is “very poor” – like North Loop near I-45 or Cullen near South Loop.  | A trip that takes 25 minutes now will take 60 minutes; stop-and-go traffic on many roads and freeways for 8.5 hours each weekday. |
| 10                  | 5 percent of the roads have “good” or “very good” pavement quality. Average road is “very poor” – like North Loop near I-45 or Cullen near South Loop.   | A trip that takes 25 minutes now will take 58 minutes; stop-and-go traffic on many roads and freeways for 8.5 hours each weekday. |
| 20                  | 10 percent of the roads have “good” or “very good” pavement quality. Average road is “very poor” – like North Loop near I-45 or Cullen near South Loop.  | A trip that takes 25 minutes now will take 56 minutes; stop-and-go traffic on many roads and freeways for 8.5 hours each weekday. |
| 30                  | 20 percent of the roads have “good” or “very good” pavement quality. Average road is “poor” – like I-45 near downtown.   | A trip that takes 25 minutes now will take 54 minutes; stop-and-go traffic on many roads and freeways for 8 hours each weekday.   |
| 40                  | 30 percent of the roads have “good” or “very good” pavement quality. Average road is “poor” – like I-45 near downtown.   | A trip that takes 25 minutes now will take 52 minutes; stop-and-go traffic on many roads and freeways for 8 hours each weekday.   |
| 50                  | 40 percent of the roads have “good” or “very good” pavement quality. Average road is “poor” – like I-45 near downtown.   | A trip that takes 25 minutes now will take 50 minutes; stop-and-go traffic on many roads and freeways for 7.5 hours each weekday. |
| 60                  | 50 percent of the roads have “good” or “very good” pavement quality. Average road is “fair” – like Westheimer between Hillcroft and Chimney Rock or North Shepherd north of the North Loop.  | A trip that takes 25 minutes now will take 48 minutes; stop-and-go traffic on many roads and freeways for 7.5 hours each weekday. |
| 70                  | 60 percent of the roads have “good” or “very good” pavement quality. Average road is “fair” – like Westheimer between Hillcroft and Chimney Rock or North Shepherd north of the North Loop.  | A trip that takes 25 minutes now will take 46 minutes; stop-and-go traffic on many roads and freeways for 7.5 hours each weekday. |
| 80                  | 70 percent of the roads have “good” or “very good” pavement quality. Average road is “good” – like Westheimer between West Loop and Chimney Rock or Southwest Freeway between West Loop and Hillcroft.   | A trip that takes 25 minutes now will take 44 minutes; stop-and-go traffic on many roads and freeways for 7 hours each weekday.   |
| 90                  | Three-fourths of the roads have “good” or “very good” pavement quality. <i>This is close to the current condition.</i> Average road is “good” – like Westheimer between West Loop and Chimney Rock or Southwest Freeway between West Loop and Hillcroft. | A trip that takes 25 minutes now will take 42 minutes; stop-and-go traffic on many roads and freeways for 7 hours each weekday.   |
| 100                 | 85 percent of all roads have “good” or “very good” pavement quality. Average road is “good” – like Westheimer between West Loop and Chimney Rock or Southwest Freeway between West Loop and Hillcroft.   | A trip that takes 25 minutes now will take 40 minutes; stop-and-go traffic on many roads and freeways for 7 hours each weekday.   |

**Table 9. Killeen Focus Group.**

| <b>Dollar Value</b> | <b>Pavement and Bridge Quality</b>  | <b>Mobility and Connections to Other Cities</b>  |
|---------------------|---|--|
| 0                   | None of the roads have “good” pavement quality. Average road is “poor” – like Buffalo Trail Road (FM 3219).   | Current roads only.  |
| 10                  | 15 percent of all roads have “good” or “very good” pavement quality. Average road is “poor” – like Buffalo Trail Road (FM 3219).  | A few major four-lane roads that do not have a median are divided.   |
| 20                  | 25 percent of all roads have “good” or “very good” pavement quality. Average road is “poor” – like Buffalo Trail Road (FM 3219).  | Half of the major four-lane roads that do not have a median are divided.   |
| 30                  | 35 percent of all roads have “good” or “very good” pavement quality. Average road is “fair” – like Veteran’s Memorial from Roy Reynolds to US 190 Highway.  | All major four-lane roads that do not have a median are divided.   |
| 40                  | 45 percent of all roads have “good” or “very good” pavement quality. Average road is “fair” – like Veteran’s Memorial from Roy Reynolds to US 190 Highway.  | All major and a few minor four-lane roads that do not have a median are divided.   |
| 50                  | 55 percent of all roads have “good” or “very good” pavement quality. Average road is “fair” – like Veteran’s Memorial from Roy Reynolds to US 190 Highway.  | All major and many minor four-lane roads that do not have a median are divided.  |
| 60                  | 65 percent of all roads have “good” or “very good” pavement quality. Average road is “fair” – like Veteran’s Memorial from Roy Reynolds to US 190 Highway.  | All major and most minor four-lane roads that do not have a median are divided.  |
| 70                  | 75 percent of all roads have “good” or “very good” pavement quality. Average road is “good” – like Veteran’s Memorial from MLK to S. Gray Street or Stan Schlueter (FM 3470) from Trimmer to Elms Road.   | All major and minor four-lane roads that do not have a median are divided.   |
| 80                  | 80 percent of all roads have “good” or “very good” pavement quality. Average road is “good” – like Veteran’s Memorial from MLK to S. Gray Street or Stan Schlueter (FM 3470) from Trimmer to Elms Road.   | All major and minor four-lane roads that do not have a median are divided. One major congested street is widened.  |
| 90                  | 88 percent of all roads have “good” or “very good” pavement quality. <b><i>This is close to the current condition.</i></b> Average road is “good” – like Veteran’s Memorial from MLK to S. Gray Street or Stan Schlueter (FM 3470) from Trimmer to Elms Road. | All major and minor four-lane roads that do not have a median are divided. A few major congested streets are widened.  |
| 100                 | 95 percent of all roads have “good” or “very good” pavement quality. Average road is “very good” – like MLK from US 190 Highway to Veteran’s Memorial Boulevard.  | All major and minor four-lane roads that do not have a median are divided. A few major congested streets are widened, and one major congested rural road is widened. |

**APPENDIX C: FUNDING ALLOCATION SURVEY RESULTS**

**Table 10. Focus Group Allocations for Each Region.**

Values represent percentage of funding for two categories in first attempt (1<sup>st</sup>) and after review and group discussion (2<sup>nd</sup>):

- pavement and bridge quality and
- mobility and rural connectivity.

| Person | Amarillo                    |                             | Brownsville                 |                             | Brownwood                   |                             | El Paso                     |                             |
|--------|-----------------------------|-----------------------------|-----------------------------|-----------------------------|-----------------------------|-----------------------------|-----------------------------|-----------------------------|
|        | Pavement<br>1 <sup>st</sup> | Mobility<br>2 <sup>nd</sup> | Pavement<br>1 <sup>st</sup> | Mobility<br>2 <sup>nd</sup> | Pavement<br>1 <sup>st</sup> | Mobility<br>2 <sup>nd</sup> | Pavement<br>1 <sup>st</sup> | Mobility<br>2 <sup>nd</sup> |
| 1      | 70                          | 90                          | 30                          | 70                          | 40                          | 70                          | 70                          | 50                          |
| 2      | 70                          | 90                          | 70                          | 30                          | 80                          | 70                          | 40                          | 30                          |
| 3      | 80                          | 90                          | 20                          | 60                          | 70                          | 70                          | 70                          | 30                          |
| 4      | 70                          | 90                          | 30                          | 90                          | 70                          | 70                          | 60                          | 40                          |
| 5      | 60                          | 90                          | 40                          | 50                          | 70                          | 70                          | 70                          | 30                          |
| 6      | 70                          | 60                          | 30                          | 40                          | 80                          | 70                          | 90                          | 10                          |
| 7      | 50                          | 90                          | 50                          | 10                          | 70                          | 70                          | 20                          | 30                          |
| 8      | 80                          | 80                          | 20                          | 20                          | 90                          | 90                          | 40                          | 60                          |
| 9      | 70                          | 70                          | 30                          | 50                          | 70                          | 70                          | 0                           | 100                         |
| 10     | 70                          | 70                          | 30                          | 30                          | 70                          | 70                          | 90                          | 10                          |
| 11     |                             |                             |                             |                             |                             |                             | 90                          | 10                          |
| 12     |                             |                             |                             |                             |                             |                             | 70                          | 30                          |

|                |    |    |    |    |    |    |    |    |    |    |    |    |    |    |    |    |
|----------------|----|----|----|----|----|----|----|----|----|----|----|----|----|----|----|----|
| Average        | 69 | 82 | 31 | 18 | 46 | 46 | 54 | 54 | 70 | 72 | 30 | 28 | 59 | 55 | 41 | 45 |
| Std. Deviation | 9  | 11 | 9  | 11 | 24 | 24 | 24 | 24 | 12 | 6  | 12 | 6  | 29 | 29 | 29 | 29 |
| Change         | 13 |    |    |    | 0  | 0  |    |    | 2  | 2  |    |    | -4 |    |    |    |

**Table 10. Focus Group Allocations for Each Region (Continued).**

| Person | Houston         |                 |                 |                 | Killeen         |                 |                 |                 | Lufkin          |                 |                 |                 | Arlington       |                 |                 |                 |
|--------|-----------------|-----------------|-----------------|-----------------|-----------------|-----------------|-----------------|-----------------|-----------------|-----------------|-----------------|-----------------|-----------------|-----------------|-----------------|-----------------|
|        | Pavement        |                 | Mobility        |                 | Pavement        |                 | Mobility        |                 | Pavement        |                 | Mobility        |                 | Pavement        |                 | Mobility        |                 |
|        | 1 <sup>st</sup> | 2 <sup>nd</sup> | 1 <sup>st</sup> | 2 <sup>nd</sup> | 1 <sup>st</sup> | 2 <sup>nd</sup> | 1 <sup>st</sup> | 2 <sup>nd</sup> | 1 <sup>st</sup> | 2 <sup>nd</sup> | 1 <sup>st</sup> | 2 <sup>nd</sup> | 1 <sup>st</sup> | 2 <sup>nd</sup> | 1 <sup>st</sup> | 2 <sup>nd</sup> |
| 1      | 60              | 80              | 40              | 20              | 30              | 50              | 70              | 50              | 70              | 50              | 70              | 50              | 30              | 50              | 50              | 70              |
| 2      | 70              | 80              | 30              | 20              | 30              | 40              | 70              | 60              | 40              | 40              | 60              | 60              | 40              | 20              | 80              | 80              |
| 3      | 70              | 100             | 30              | 0               | 70              | 50              | 30              | 50              | 50              | 50              | 50              | 50              | 50              | 60              | 40              | 40              |
| 4      | 75              | 85              | 25              | 15              | 50              | 90              | 50              | 10              | 60              | 60              | 40              | 40              | 60              | 60              | 40              | 40              |
| 5      | 50              | 70              | 50              | 30              | 70              | 60              | 30              | 40              | 60              | 60              | 40              | 40              | 70              | 70              | 30              | 30              |
| 6      | 70              | 70              | 30              | 30              | 40              | 40              | 60              | 60              | 60              | 60              | 40              | 40              | 50              | 50              | 50              | 50              |
| 7      | 70              | 70              | 30              | 30              | 80              | 80              | 20              | 20              | 60              | 60              | 40              | 40              | 60              | 30              | 70              | 70              |
| 8      | 60              | 60              | 40              | 40              | 100             | 100             | 0               | 0               | 60              | 60              | 40              | 40              | 60              | 30              | 70              | 70              |
| 9      | 40              | 40              | 60              | 60              | 60              | 60              | 40              | 40              | 90              | 90              | 10              | 10              | 50              | 50              | 50              | 50              |
| 10     | 80              | 80              | 20              | 20              | 80              | 60              | 60              | 40              | 50              | 50              | 50              | 50              | 49              | 49              | 51              | 54              |
| 11     | 40              | 40              | 60              | 60              | 60              | 60              | 60              | 60              | 60              | 60              | 60              | 60              | 60              | 60              | 60              | 60              |
| 12     | 40              | 40              | 60              | 60              | 60              | 60              | 60              | 60              | 60              | 60              | 60              | 60              | 60              | 60              | 60              | 60              |

|                |    |    |    |    |    |    |    |    |    |    |    |    |    |    |    |    |
|----------------|----|----|----|----|----|----|----|----|----|----|----|----|----|----|----|----|
| Average        | 62 | 70 | 38 | 30 | 59 | 63 | 41 | 37 | 60 | 58 | 40 | 42 | 49 | 46 | 51 | 54 |
| Std. Deviation | 14 | 18 | 14 | 18 | 24 | 22 | 24 | 22 | 13 | 13 | 13 | 13 | 18 | 19 | 18 | 19 |
| Change         | 8  |    |    |    | 4  |    |    | -2 |    |    |    |    |    | -3 |    |    |

## **APPENDIX D: FUNDING ALLOCATION COMMENTS**

### **Focus Group Comments on Funding Allocation**

#### **Amarillo**

1. Quality of road/pavement is much more important to me than changing lane configuration. Potholes and guardrail quality is more important than adding lanes.
2. Chose 90/10 in order to keep current conditions from deteriorating even though I feel current conditions could be improved upon.
3. Think the current conditions are met closest. And happy with current road conditions in Amarillo. I think the roads I-40/I-27 are maintained well.
4. Like the roads in current condition. Would not want pavement and bridge quality to go down to improve mobility.
5. Want to keep status quo on roads. Another priority would be to improve on-ramps and off-ramps along I-27. Some are too short (e.g., Georgia southbound), and some are dangerous (e.g., Hillside southbound – hill by off-ramp makes it hard to judge traffic if you are on access road).
6. Conditions in Amarillo are great. Sacrificing condition for mobility and ease of use seems acceptable to me.
7. I appreciate the TxDOT roads that we currently have in Amarillo. I see no major problems.
8. I like the current conditions. I think we could readjust our focus slightly, but would again like to bring it back to the 90/10 mix in the future.
9. I think our road and mobility conditions are good where they're at, and I don't want them to change.
10. I'm happy with the pavement quality at this time.

#### **Brownsville**

None

#### **Brownwood**

1. Busy residential areas really need to be four lanes like TxDOT is doing. For example, Austin Avenue.
3. The roads that are traveled on regularly need to be maintained, but the minor four-lane roads do not need dividers.
4. Initially, I chose 60/40. With a second look, before our discussion – I noticed that for \$10 more my average road condition goes from “fair” to “good.” In deciding whether I wanted to spare \$10 from my Column B, the fact that all of my major four-lane roads are divided was good enough for me. In all honesty, I feel that a division of any sort on minor four-lane roads is more of a hindrance.

5. I chose this because the average road is good versus fair, so both categories benefit to a great extent.
6. Not as important to have four lanes divided as it is to have good quality of roads to avoid accidents and car repairs.
7. Make roads safer for even safe, good drivers and for vehicle safety as well (less broken shocks for example or flats).
9. All four-lanes need to at least have a divider to help cut down accidents. If the roads are at least of good quality, there won't be as many accidents.
10. All the roads should be in good condition and wider for better traffic flow.

### **El Paso**

1. Changed to incorporate more funding for mass transit and commuter transit (i.e., light rail, commuter trains).
2. Mobility is key for other forms of transportation.
4. If these areas are already doing well, they need to continue to be maintained. Time is relative, and without alternate routes, I'd be OK with 20 minutes and the increased time to travel.
5. Good point made on time versus upkeep. By 2030, gas will be even closer to running out; mass transit will be imperative, including for movement of goods. So – why maintain roads for types of transport that are not sustainable? Use funds for mobility planning.
6. Try to make mobility a little better.
8. I feel mobility and connection to other cities is important. Congestion needs to be reduced.

### **Houston**

8. Safety.

### **Killeen**

2. I guess to be fairer to the citizens of Texas, and not only me, pavement should be taken into greater consideration. If pavement and bridges were to be divided into their own separate pools, I would have given less to pavement. To me, congestion and traffic are more frustrating and annoying.
3. I changed due to the fact that as I'm driving on these roads, my number one concern is safety. I didn't consider congestion, but after hearing other viewpoints, congestion and pavement quality are equally important to me.
4. I changed my mind in order to prioritize the funding so that 88 percent of the roads have "good" or "very good" pavement quality because it's important for safety of bridges and road quality for vehicle maintenance. Maintenance is important for major roads.
5. Sacrificing road and bridge quality for congestion is difficult to achieve. Reduction in congestion requires 80 percent to go to the mobility column. This would reduce the average pavement and bridge quality to fair.
6. TxDOT should have increased funding.
7. Need more money for mobility and connections to other cities.



8. More money for expansion on major congested roads.

**Lufkin**

4. Opinion unchanged after discussion.

5. Keep up condition of roads at 60 percent but work to divide for safety.

10. Slower speed limits.

APPENDIX E: DEMOGRAPHICS OF FOCUS GROUPS

Table 11. Demographics of Focus Groups.

| Location    | Gender |        | Age   |       |       |       |       |       |       |     |     |                       | Education        |                     |                          |              |                |          |     |
|-------------|--------|--------|-------|-------|-------|-------|-------|-------|-------|-----|-----|-----------------------|------------------|---------------------|--------------------------|--------------|----------------|----------|-----|
|             | Male   | Female | 18-19 | 20-29 | 30-39 | 40-49 | 50-59 | 60-69 | 70-79 | 80+ | Unk | Less than high school | Some high school | High school diploma | Vocational / Tech School | Some college | College degree | Postgrad | Unk |
| Amarillo    | 3      | 7      |       | 5     |       | 3     |       |       |       |     | 2   |                       |                  | 1                   |                          | 4            | 3              |          | 2   |
| Arlington   | 3      | 4      |       | 1     | 1     | 3     | 1     | 1     |       |     |     |                       |                  |                     |                          | 5            | 2              |          |     |
| Brownsville | 6      | 4      |       | 3     | 2     | 1     | 4     |       |       |     |     | 1                     |                  | 3                   | 1                        | 4            | 1              |          |     |
| Brownwood   | 4      | 6      |       | 3     | 2     | 3     | 1     |       |       | 1   |     |                       |                  | 4                   |                          | 3            | 2              |          | 1   |
| El Paso     | 7      | 5      |       | 2     | 4     | 1     | 2     | 1     | 1     |     | 1   |                       |                  |                     | 1                        | 5            | 3              | 2        | 1   |
| Houston     | 4      | 7      | 1     | 3     | 4     | 1     | 2     |       |       |     |     |                       |                  |                     |                          | 4            | 7              |          |     |
| Killeen     | 4      | 5      | 1     | 3     | 2     |       |       | 2     | 1     |     |     |                       |                  | 2                   | 1                        | 4            | 2              | 1        |     |
| Lufkin      | 4      | 6      |       | 4     |       | 2     | 1     | 2     |       |     | 1   |                       |                  |                     |                          | 4            |                | 5        | 1   |
| Total       | 35     | 44     | 2     | 24    | 15    | 14    | 11    | 6     | 1     | 1   | 5   | 0                     | 1                | 10                  | 3                        | 33           | 20             | 6        | 5   |

## APPENDIX F: VIDEO QUESTIONNAIRE RESULTS

**Table 12. Video Questionnaire Results.**

|  | El Paso | Amarillo | Brownsville | Brownwood | Lufkin | Arlington | Totals |
|--|---------|----------|-------------|-----------|--------|-----------|--------|
| Did this video provide new information for you about future transportation issues? |         |          |             |           |        |           |        |
| Yes  | 10      | 8        | 8           | 7         | 5      | 4         | 42     |
| No   | 2       | 2        | 2           | 3         | 5      | 2         | 16     |
| Was there any information that surprised you?                                      |         |          |             |           |        |           |        |
| Yes  | 6       | 3        | 6           | 3         | 2      | 3         | 23     |
| No   | 6       | 7        | 3           | 6         | 8      | 3         | 33     |
| Was there too much information or not enough?                                      |         |          |             |           |        |           |        |
| Too much   | 0       | 0        | 1           | 0         | 0      | 0         | 1      |
| Not enough   | 5       | 7        | 5           | 8         | 7      | 2         | 34     |
| Just enough  | 1       | 0        | 0           | 0         | 0      | 1         | 2      |
| Do you have a smart phone?   |         |          |             |           |        |           |        |
| Yes  | 5       | 9        | 3           | 7         | 7      | 5         | 36     |
| No   | 7       | 1        | 7           | 3         | 3      | 2         | 23     |
| Do you use it to plan your travel?   |         |          |             |           |        |           |        |
| Yes  | 2       | 2        | 2           | 2         | 5      | 3         | 16     |
| No   | 3       | 7        | 3           | 6         | 2      | 4         | 25     |
| Do you know about intelligent transportation systems?                              |         |          |             |           |        |           |        |
| Yes  | 9       | 4        | 1           | 2         | 3      | 1         | 20     |
| No   | 3       | 6        | 9           | 8         | 7      | 5         | 38     |
| Are you in favor of them?  |         |          |             |           |        |           |        |
| Yes  | 10      | 9        | 6           | 3         | 7      | 2         | 37     |
| No   | 0       | 0        | 0           | 1         | 0      | 1         | 2      |
| Maybe  | 1       | 0        | 0           | 1         | 0      | 0         | 2      |
| Do you think that state population will dramatically increase?                     |         |          |             |           |        |           |        |
| Yes  | 10      | 10       | 10          | 10        | 8      | 7         | 55     |
| No   | 2       | 0        | 0           | 0         | 1      | 0         | 3      |
| Do you think we will run out of oil?   |         |          |             |           |        |           |        |
| Yes  | 10      | 7        | 7           | 7         | 6      | 1         | 38     |
| No   | 2       | 2        | 3           | 3         | 3      | 6         | 19     |
| Do you plan to buy a hybrid or alternative fuel vehicle in the next few years?     |         |          |             |           |        |           |        |
| Yes  | 7       | 2        | 6           | 3         | 2      | 3         | 23     |
| No   | 3       | 8        | 4           | 7         | 6      | 4         | 32     |
| Maybe  | 1       | 0        | 0           | 0         | 1      | 0         | 2      |
| Where do you live?   |         |          |             |           |        |           |        |
| Urban  | 3       | 3        | 2           | 2         | 0      | 2         | 12     |
| Suburban   | 6       | 5        | 6           | 3         | 1      | 3         | 24     |
| Rural  | 2       | 1        | 2           | 5         | 8      | 0         | 18     |
| How do you primarily travel?   |         |          |             |           |        |           |        |
| Car  | 10      | 10       | 9           | 10        | 9      | 7         | 55     |
| Bus  | 0       | 0        | 0           | 0         | 0      | 0         | 0      |
| Train  | 0       | 0        | 0           | 0         | 0      | 0         | 0      |
| Motorcycle   | 1       | 0        | 0           | 0         | 0      | 0         | 1      |
| How regularly do you use the transportation system?                                |         |          |             |           |        |           |        |
| Daily  | 5       | 6        | 5           | 7         | 5      | 2         | 30     |
| Almost daily   | 0       | 0        | 1           | 1         | 2      | 3         | 7      |
| Several time a week  | 0       | 0        | 1           | 0         | 0      | 0         | 1      |
| Once or twice a month  | 0       | 0        | 2           | 0         | 0      | 1         | 3      |
| Less than once a month   | 3       | 1        | 1           | 0         | 1      | 1         | 7      |

## **Comments Received on the Video Questionnaire**

*Was there any information in the video that surprised you?*

### ***El Paso***

Charging fees based on use

Yes, the damage of road structure due to less gas taxes

Surprised to see we had taken all aspects of transit into consideration

Renting a vehicle by the hour

Seeing the desolation of the areas – L.A. freeways and abandoned gas stations along with alternative options of train and ride share made me think twice

The idea of self-driving vehicle

These are all ideas that are being presently used

### ***Amarillo***

cars that talked to roads/highways; that's awesome

paying per mile; doubt it would work

mileage-based user fees – this seems like it would be very expensive to initiate and difficult to enforce

shopping in the car didn't seem feasible because someone has to deliver; mileage tax – nasty thought! Unfair

### ***Brownsville***

rechargeable electric car was great; communities where everything was accessible

what if we run out of oil

less gas consumption means less money, and there would be a need to get money from other sources like charging to use the highway

roads talking to cars

communication

teleworking

surprised by the idea of being charged for the amount of miles you drive similar to a phone bill

### ***Brownwood***

some solutions to the issues were surprising

roads that talk to cars and shopping while you drive – scary

roads that talk to cars and shopping while you drive – they're both a little disheartening

### ***Lufkin***

organized ride-sharing – is it safe?; how do you know you're getting in the car with a sane person?

the implication that self-driven cars are a possibility

trains that could possibly talk to cars and the idea of teleworking

all these modes of transportation have been discussed for years

before “no” oil there will be very expensive oil; \$ 10.00/gallon will change behaviors dramatically

### ***Arlington***

it made me feel the future is dead

tomatoes at \$24.00

higher transportation for deliveries

*What do you know about intelligent transportation systems (ITS)?*

### ***El Paso***

digital signs with road condition updates

computer-guided vehicles programmed to enter and exit at specific points

carpool to and from work

tramways, charter buses, park and ride

highway alerts

ITS can support an efficient mass transportation system

### ***Amarillo***

computers in the car navigate you to your destination kind of like autopilot

it is a way to evaluate travel needs on a real-time basis using Internet access and then quickly fill the needs

cars driving in accord with other cars around them

### ***Brownsville***

sounds a little too futuristic and makes me uneasy because what if all the kinks aren't worked out that you can have your car drive you

### ***Brownwood***

systems designed to work with smart cars to drive either more efficiently or independently

***Lufkin***

real-time traffic conditions are very nice

could help drivers change their habits concerning daily driving

***Arlington***

I believe it is tracking your car with GPS or something like On Star

Mercedes is using smart cars to keep you awake, brakes for you and keeps in your lane

GPS – use it for trips

*How would a big population boom affect you?*

***El Paso***

short term: roads more congested; takes longer to travel; long term: gasoline used up sooner; radically changes all transport for work, commerce and personal travel would all be curtailed my ability to drive from A to B would significantly deteriorate; confine me to a smaller area more congestion on the road

it would encourage me to spend my time more wisely

unknown – things may get worse before they start to improve

congestion and wait time on just about everything

minimally

it would affect me tremendously because this causes an increased strain on resources and infrastructure

streets/highways will be more congested, causing longer travel times and less personal travel

***Amarillo***

would only increase current conditions and problems

roads would have to be expanded; tax would have to be raised for more work on highways

take longer to get places

more congestion on roads future comments between home and work

increased congestion on the roads

besides traffic and Texas, probably not very directly

it would help the economy; make roads more congested

probably not dramatically; most growth will occur in Dallas-Fort Worth, Austin, Waco, etc.

more congestion on highways and interstates, delays in arrival to locations

### ***Brownville***

it affects the way you plan your day and/or recreational activities

traffic congestion/accidents

more taxes

jobs, more time on the road

higher population = more traffic congestions = more commute time

more people on the road would mean having to leave earlier to get to work

smoke fumes

it will affect the larger cities more because that were live to have a better lifestyle

make it even harder to find work, which would lean to even more poverty, which would mean less traveling and less money available for repairing our roads

### ***Brownwood***

take long to get to work and places

have to deal with more people on the street; I left the big city of Houston because of crowds

we live in the country, and I can see our country road and area being a subdivision

more traffic; more time spend in daily commutes

more traffic; more risk

heavy increase in traffic

more crime, more traffic, cost of living will increase

in every little aspect of my whole life

I would expect it to at least double in 50 years

### ***Lufkin***

more traffic

more traffic and more pollution

might make jobs and goods even harder to come by

crowded streets and stores

it would most definitely affect my career choice and if I choose to relocate

more congestion on roads; cost increases due to shortages

larger cities will spread out, creating more congestion outside our metropolitan areas

negatively; being in a rural community in a large boom would have limited effect; however, in a big city longer transit times

maybe there would be accompanying mass transit

### ***Arlington***

more cars on the highway, which mean more deterioration; more congestion on the highways, more businesses going up in growing areas

more people = more automobiles and congestion

traffic, pollution

more traffic, crime, cost of living will go up

traffic, commuting issues

more congestion on highways; less food

*How would a big population boom affect your local transportation systems?*

### ***El Paso***

they would crash since they are stressed already

it would definitely overwhelm the systems; less mobility would affect consumer buying habits

more traffic lights

overcrowding/congestion

mass transit or monorail would be priority

jam it up more

big time – our freeway, I-10, wouldn't support it at the already existing bottleneck areas

I believe public transportation will increase

force them to be smarter and more efficient

even the slightest increase would affect it

more vehicles on the roadways

time and money; crowding

### ***Amarillo***

cost and demand

it would take longer to build, fix or repair roads

longer to get places

more necessary to develop public transportation

have a negative impact; already congested in some areas

we have very poor public transportation to begin with, so hopefully it would improve as need increased



on Highway 287S from Amarillo to Wichita Falls would probably have to be widened; roads and traffic lights would flow less smoothly

we would not get as much funding in Amarillo for roads and bridges due to the increased needs in larger cities

I'm sure it would be a negative effect but not overwhelming

Congestion

### ***Brownsville***

more traffic; time getting to and from

slower

more traffic, more driving time

the roads are ill equipped to handle a sharp increase in population

hopefully it would increase local transportation so that we would be less dependent on our cars and maybe ease up gas dependency

very little; the commute in the RGV is not that hectic compared to metro cities

we would need wider roads to fill the need

crowded streets

more traffic

it already seems impossible to imagine them getting any worse, so I can't even comprehend the trouble it would bring on us

### ***Brownwood***

could not get to A and B safely and on time

more congestion on the streets

I can see traffic backed up

more people driving as we do not have mass communication

it would overwhelm it

none

more road expansion and construction and maintenance

more congestion on the streets, streets deteriorating more quickly, more accidents

nobody would ever get anywhere in a timely manner

more cars = more wrecks and deterioration; more time for daily travel

### ***Lufkin***

more traffic, so it would take longer to get somewhere

it will make them regret not thinking further ahead about the what-ifs

what local system?; it's every person for himself

more street traffic

we would actually need to create one

none, we have a very small system

increase in demand requires more money to provide; users cannot cover the costs of their use if current system for financing is not modified

more cars moving into rural areas

longer transit times

if mass transit was available, there would be no problem

### ***Arlington***

again more money from taxpayers because more drivers who are tearing up barriers, deteriorating freeways, causing transportation system to spend more on employees to make repairs

I would have to figure out an alternative way such as public transportation

we would like a bigger transportation system

take longer to get anywhere

it will tax the transportation system

probably be forced to improve them

more cars on road unless they convert to smaller cars

*How do you think the state should prepare to deal with resulting transportation demands?*

### ***El Paso***

in conjunction with local, county and federal agencies

innovate with new technologies

lower the percentage cost of repairing roads

inform the public with education

think, get organized, reduce waste and plan projects and funding

start talking with local city government and MPO; involve the public; begin doing county-wide surveys allowing for suggestions as a precursor for updated changes

how to find funding without hindering or causing higher taxes

coordination of transportation with public and private section

population will continue to grow, state needs to find ways to generate revenue for projects

be apprised of the needs of the community

take action now

### ***Amarillo***

research and public relations to find solutions

find ways to increase other issues that affect TxDOT

make bigger roads

raise taxes, develop additional public transportation, give incentives to conserve energy

must increase funding, perhaps by increasing the flat tax currently being used

increase gas tax gradually; possible registration cost increase

civil engineers need to be hired to help plan and to forecast how demands will be made upon the transportation systems

using technology

keep roads in good condition/encourage deployment of affordable mass transit

possibly widen highways; maybe other modes of transportation to reduce maintenance cost

### ***Brownsville***

in-state gas and oil production

more focus meetings; inform public

when building roads, bigger is better; while it may cost more in beginning, the fruits will be reaped

more taxes to accommodate the demand

they will have to find the funds to deal with any and all transportation issues

survey

build more highways, evacuation systems and increase public transportation

it seems like our only option is to increase taxes or in a very desperate attempt reach out to the people and try to raise money

### ***Brownwood***

find out what is best way, work to get traffic moving safely

better planning, fewer projects at one time to get them done quicker

do fund raisers; ask some of the more fortunate people for generous donations

the governor is going to have to be more involved, and the people in transportation work field need to be more connected with each other

plan ahead for additional funding and multiple streams of funding

more tax on vehicle registration

find ways to save budget dollars while planning and constructing more roads

better funding, better planning, one job at a time  
planning, funding ideas, anticipating problems before they arise  
more mass transportation, buses and transit

### ***Lufkin***

think public transportation  
commuter rail infrastructure  
come up with innovative ideas from the public and gather different opinions  
improve existing roads  
more mass transit and ways to fund it  
road maintenance should be maintained  
research into population behavior and options for revenue once oil is obsolete  
mass transit – coordinate city planning; rail is a must, provide the backbone

### ***Arlington***

build more highways and attach freeways to unexpected areas of travel  
we need to increase our research in order to come up with a plan to avoid congestion before it gets out of control  
transit, wider roads  
fix roads, widen, new roads, carpool lanes  
start expanding now  
find new ways to increase funding  
not sure

*How will running out of oil affect you?*

### ***El Paso***

the same way it will affect everyone; completely revamp daily work and personal life  
will need to replace vehicle and will probably do less traveling  
clean the air and create an increase in the need for travel; therefore, we will need to find other ways to get revenue for our roads  
I will have to find different methods of transportation  
I believe technology is evolving as well, I feel we will have no use for oil in our vehicles in the future  
it will alter the modes of transportation available

will need to find alternatives for transportation  
cost

### ***Amarillo***

unless an alternative is provided, it would change many aspects of daily life  
no oil, then no vehicle; we need different ways of traveling other than gasoline  
take forever to get to work on a bike  
will need to find alternative transportation, fuels, etc.  
a complete transportation overhaul would be necessary, which would affect everyone  
we will eventually be forced to drill inside our own borders  
it will affect every aspect of my life  
unless an alternative is provided, it would be devastating

### ***Brownsville***

life as we know it would be totally altered, so alternative ways of reaching our destination would  
need to be explored  
have to find new fuels  
everything; transportation costs will go up, which will be passed on to the consumer  
it would just set us back to old time when everyone rode horses  
the cost of gas among our other everyday purchases would increase  
it will increase gas prices  
unless we're able to create a new standardized form of energy, I don't know how I'll be able to  
get to work or school

### ***Brownwood***

make transportation hard to get around  
gas, food, all prices rising; change in transportation  
will have to find other means of transportation  
keep things like groceries going up and not be able to get out as much, example: church, movies,  
ball games  
I can't even begin to fathom all the ways

### ***Lufkin***

no cars with gas engines  
it won't happen in my lifetime  
I better dust off my bike or learn to ride a horse

I believe another technology which will be better than fossil fuels will replace it  
we won't run out overnight, so I guess I would have to invest in an electric vehicle  
before we run out, it will be expensive and change behavior; less driving, concentrated living  
area, more fuel-efficient vehicles

***Arlington***

would have to carpool

have to get a new car

there are hidden reserves tied up in politics

*What is the main purpose of your regular use of the transportation system?*

***El Paso***

commuting to work

commute to work

to and from work

work/errands

work/errands

commuting to work

work/errands

commute

commute

work

***Amarillo***

work/errands

work

work

work/errands

work/errands

errands

errands

work

work/errands

***Brownsville***

commuting to work

doctor visits/grocery shopping

work

errands

work/errands

work

work

school

work/school

***Brownwood***

work/errands

work/errands

work/errands

work/errands

business/errands

work/errands

work

commute to work

work/errands

work

***Lufkin***

work/school

commuting to work

commuting/errands

shopping trips

work/errands

work/errands

work/errands

work/errands

***Arlington***

work

work/errands

work

work

work/errands

commute to work/errands

*What transportation solutions should we focus on?*

***El Paso***

mass transportation options

communication and coordination of various levels of bureaucracy

create another highway or expand the highway that runs from east side to west side of El Paso

mass transit

funding roads getting away from oil

cooperate with counties and cities to plan overall solutions; not act individually

mass transit train development above freeway and toll freeway

the funding of better roads

light rail and high-speed rail

mass transit and reduce environmental impacts

mass transit

efficient transportation

***Amarillo***

pavement conditions, safety conditions and awareness

funding/safety

how to better use the money you have, such as don't give as much to public education; they have plenty of resources

develop or assist with public transportation; railroads, magnetic highways

maintenance of roads and safety

future need and future funding – always

sufficient number of lanes on state roads and highways; synchronize traffic lights

anything we can do to stop using oil

maintain roads, encourage people to get fuel-efficient vehicles; develop mass transit for cities and between cities

expansion of highways in metro areas focusing on safety of small farm roads



### ***Brownsville***

more bus systems

public transportation

more, faster ways of traveling to certain main highways

general maintenance

bigger roads; in theory this would slow down congestion

how to tax smart cars/hybrids because without fuel tax there will be no roads

maintain road condition

better maintenance

safety and public transportation

### ***Brownwood***

cleaner and safer

more efficient planning; different areas than we already have for raising necessary funds

keep roads safe for drivers and finish projects in a timely manner; make roads better, not worse

fixing one area at a time

planning ahead and being open to new ideas

improve roads, focus on one project instead of 50

cost reduction; road planning

maintenance

safety now and planning for the future

higher-quality roads that last

### ***Lufkin***

more trains

more public ways to do things to cut down on oil

passenger and light railways

safety and cost management

better management of existing facilities

ways to lessen the need to travel for some purposes; cheaper, more cost-effective and less-polluting models

accountability; let the public know and understand decisions

interested in the micro transit systems in bigger cities via networking and ridesharing and automated vehicles

build the rails; privatize the trains

***Arlington***

highway expansion

more lane highways, better transportation system

transit

more lanes and more roads

expand

planning and expanding

wider highways, studies, aerial views

*Please share other comments about the video.*

***El Paso***

great idea to have focus groups; should give you input and gives the public an idea of what you do

maintaining roads is important to eliminate additional costs for auto repair

the video made great points; nothing is forever; people will always travel, and it is more important to get to your destination than how

cool

I enjoyed the presentation – thanks

I feel it opened my eyes to the future of transportation

the technology to improve the system is there, the public just needs to get involved and informed

***Amarillo***

video needs more info, more pros and cons

video had great teasers but lacked actual information – more facts would be very appreciated

fairly pointless – waste of state funds

in general it was a good video in that it promoted thought and a need to find more information

make another and promote it to the general public

***Brownsville***

video was very enlightening; offered ideas I was not aware of

very helpful

I liked the video; it touched on several topics I had never heard about, but it didn't go into detail

how does TxDOT tax the cars that use vegetable oil or are solar powered?

video had some good insight

wish it was more elaborated

### ***Brownwood***

if people were more friendly, trustworthy, carpooling is an awesome solution for cutting down on traffic

good; it said a lot in a short amount of time

video had a lot of neat ideas to solve transportation issues

very enjoyable

quite interesting, but I wish it were a bit longer and just a tad more informative

it didn't mention hovercrafts; accurate but not enough info or details about each subject

### ***Lufkin***

gas – wow

please give more concrete information; when are these technologies coming?

the video was an eye-opener; great video

I thought it might have been funded by oil interest because one part of it tried to make me feel scared about running out of oil

concise and to the point, maybe more could be conveyed about intelligent and alternative driving plan, plan, plan – no more bulldozing new roads

### ***Arlington***

it was an advertising medium to make you aware of what to expect

too focused on liberal ideas!

higher costs for everything



# **PHASE III FINAL REPORT: PUBLIC PERCEPTIONS REGARDING THE DRAFT 2011 TO 2015 STRATEGIC PLAN OF TXDOT—FOCUS GROUP RESULTS**

## **EXECUTIVE SUMMARY**

A strategic transportation plan must reflect the interests and desires of several groups. It must illustrate the issues and challenges faced by the agency and the solutions that will address them. It must be inspirational and visionary, but also descriptive. One important element that must be satisfied is public acceptance. To that end, TxDOT contracted with TTI to obtain feedback from Texans through focus groups on the draft 2011 to 2015 Strategic Plan. Most of the focus group participants had attended previous discussions about problems and improvements goals and were already familiar with TxDOT's intent to gain the public perspective on ways they can do better. Three cities were selected from the original eight targeted in the previous phase: Arlington, Brownwood, and El Paso. The locations offered geographical diversification as well as representation from both urban and rural areas.

Each of the six goals specified in the strategic plan were addressed:

- Goal: Cultivate an organizational structure and strategy designed to address the future multimodal transportation needs of all Texans.
- Goal: Facilitate the development and exchange of comprehensive multimodal funding strategies with transportation program and project partners.
- Goal: Maintain the existing Texas transportation system.
- Goal: Promote congestion relief strategies.
- Goal: Enhance system connectivity.
- Goal: Enhance safety for all Texas transportation system users.

The focus groups discussed the goal statements and the objectives, strategies, and performance measures designed to achieve them. Participants were asked rank these goals in order of importance; in Arlington and El Paso, the participants were asked to vote before and after the detailed discussion.

## **Key Focus Group Observations**

Comments from the three focus groups were similar in a number of ways. There were many positive statements about the interest TxDOT was showing in public opinions, and the material was generally well received. A few improvements were suggested for each goal and the associated material. There were also several comments that broadly applied to all the goals, the process, the reporting, and the information that was being displayed for the Plan in general. A few key suggestions are listed below:

- Prioritize the goals – Identify which goals or elements of goals are most important.
- Reporting – The display and level of information was frequently noted as a way to gain (or lose) public input and trust. Statements such as those below suggest that an aggressive, continuous, and far-reaching public input process should be maintained:

- “We’re paying the taxes, we should be able to see what’s happening.”
  - “Show us the condition or performance in color, on maps and in pictures.”
  - “Show us the information on-line.”
  - “Report it more often for important items if it doesn’t cost too much.”
  - “More information means TxDOT looks like they have less to hide.”
  - “Having transparency listed in the goals so much makes the reader ask ‘why?’ and suspect there is a problem.”
- Contact information – Participants wanted a point of contact (e.g., email, phone) as a way to let them express their opinions about conditions or about thresholds/standards that are being used to grade the conditions. In addition, they would like a specific local contact for projects or an expert to contact about particular programs. A “hotline” would be good summary of what was being requested.
  - Describe the comparison points – Providing the readers a link to additional information about each performance measure is a key education element. Answering questions such as “What is good?,” “What is key?,” “What is safe?,” “What is a pavement condition rating?,” and “What is a state congestion index?” will be important as the information is more widely disseminated.
  - Use clearer wording – It would be better to remove the jargon that is used in the Plan, but if it cannot be removed or softened, it should be explained. Participants suggested that the Plan “use words that regular people can understand.” One said “it seems like a team of lawyers wrote this and, in some cases, they didn’t even talk to each other.” Links to a glossary or a method to define technical terms would be helpful.
  - Evaluate current and future conditions and show the trends – Participants wanted to know the current and future conditions and how those compared to desirable conditions or targets, but they also wanted to know the trend in the measures. “Are we getting better or worse and how quickly?” was the way a number of participants stated it.
  - Interest in multimodal solutions – There was a significant interest in solutions other than building roadways, and the participants seemed uncomfortable with the few mentions of a comprehensive transportation solution strategy. A few mentioned feeling like the “multimodal” term was used to make the document politically correct rather than representing a commitment.
  - TxDOT has to bring the public into this plan – Follow-up public information and continued consultation will be important for the long-term success of the Plan.
  - Awareness should be the “first thing” – Making Texans aware of the issues and the information that has been developed via the internet, on electronic billboards, or through any other medium was mentioned by several participants.
  - Details! – More than one participant said they wanted more “meat and potatoes” with the Plan, both because they were curious about the problems and solutions and

because they thought the details would reinforce the perception of expertise being applied to the problems.

### **Communication Elements**

In various ways the participants raised the issues of “communication” and “trust” together. The linkage was most frequently made on the topic of reporting the measures, but the suggestions were made on several topics.

- Frequent reporting of elements or conditions – They want information very frequently if events or conditions change or if the cost to make it available on the internet would be relatively small. The groups had a sensitivity to the cost of generating the data but felt that if the information changed or if the cost to produce it was very low, there was no reason to not provide it to the public. Annual updates would be appropriate where information is difficult to update, regular data collection schedules are used, or where the measure does not change very much.
- Display – Maps that allow users to look at conditions, performance, and factors on specific roads were the preferred way to report almost every measure. From a practical standpoint, some measures may not be “mapable,” but connecting various database elements such as pavement condition, crash rate, congestion levels, and improvement projects to map layers allows the public to ask their own questions. They can perform their own examination and gain a comfort level by connecting their experiences with the measures being used to guide investments.
- Use of data – There seemed to be recognition that the measures and data in the maps would not be used as “everyday reading” for most people, but the availability was important to ensuring that Texans feel their transportation funding is being well-spent. This will present some challenges (e.g., pavement maintenance efforts on roads that are not “falling apart”), but providing the information with explanations would appear to be better than any suggestion of hiding the data.
- Feedback – Any communication tool should have a response mechanism that allows and even elicits comments on the information. One of the most frequent comments on this topic was along the lines of “who do I call for more information?” A phone number, email account, web address, or other information should be provided.

### **Prioritizing the Goals**

Participants viewed safety and congestion as the two most important issues among the five votes taken in the three focus groups (Table 13). The discussions during the focus groups also indicated that these two topics were the greatest concerns. The maintenance and connectivity goals were the next highest rated goals. Interestingly (and perhaps indicative of the challenge faced), the funding goal was not very highly rated, although the participants recognized the funding shortfall faced by TxDOT.

**Table 13. Prioritizing the Goals.**

| Goal                     | Brownwood |                  | El Paso          |                  | Arlington        |                  |
|--------------------------|-----------|------------------|------------------|------------------|------------------|------------------|
|                          | Before    | After            | Before           | After            | Before           | After            |
| Maintain                 | n/a       | 2.5 <sup>○</sup> | 3.5 <sup>○</sup> | 2.9*             | 4.1              | 3.9 <sup>○</sup> |
| Funding                  | n/a       | 4.0              | 4.7              | 4.7              | 4.3              | 5.0              |
| Congestion               | n/a       | 1.6*             | 2.7*             | 3.4 <sup>○</sup> | 2.4*             | 1.9*             |
| Connectivity             | n/a       | 2.6 <sup>○</sup> | 4.0              | 3.9              | 3.4 <sup>○</sup> | 2.8*             |
| Safety                   | n/a       | 1.1*             | 2.2*             | 2.4*             | 2.6*             | 2.7*             |
| Organizational Structure | n/a       | 3.3              | 3.9 <sup>○</sup> | 3.7 <sup>○</sup> | 3.9 <sup>○</sup> | 4.8              |

\*1<sup>st</sup> or 2<sup>nd</sup> highest ranked  
<sup>○</sup>3<sup>rd</sup> or 4<sup>th</sup> highest ranked

Although developing a prioritized list of goals was not the point of the focus group, the level of importance indicated by the participants is an indication of the level of effort that may be needed to convince the public of the importance of the goal. The maintenance and connectivity goals, notably, were ranked as more important in the “after” period in the two locations where both votes were conducted, suggesting the information received during the meeting was helpful in swaying public opinion.



## FULL REPORT

In Part 1 of this effort, TxDOT desired to develop an understanding of the current perceptions of the public about TxDOT. The focus groups assessed the strengths and weaknesses of TxDOT. Issues and priorities that are important to the public were identified. The results of this research effort provided input to the department as the new strategic plan was developed. With the proposed plan developed, TxDOT wished to get reactions from a small number of people that participated in the earlier research effort. Out of the eight focus groups held in Part 1, three were selected for additional conversations: Arlington, Brownwood, and El Paso. These three locations offer a geographic diversification as well as representation from both urban and rural areas. Comments from the focus groups are found in [Appendix A](#), and demographics are found in [Appendix B](#).

A discussion guide was developed to direct the focus group conversation pertaining to TxDOT's Draft Strategic Plan for 2011 to 2015. Since the focus groups were primarily comprised of individuals who participated in Part 1, they already had an understanding of the process that TxDOT is going through. The Discussion Guide and the Draft Strategic Plan are found in [Appendix C](#) and [Appendix D](#), respectively. Slides presented to the focus groups are found in [Appendix E](#).

Each participant was sent the draft plan for review prior to the focus group meeting. The six goals were discussed one at a time. The facilitator asked questions about appropriate phrases, technical terms, and significance and sought feedback on other goals that would be more useful and meaningful. Each of the objectives, strategies, and performance measures were discussed as well.

### Participant Recruitment

For these three focus group sessions, the participants from the previous phases of this project were recruited in Arlington, Brownwood, and El Paso. In Arlington, six previous participants agreed to attend the session, and six new participants were recruited via Craigslist. In Brownwood, all former participants agreed to attend, and one new person was recruited by word-of-mouth from one of the previous participants. In El Paso, six previous participants agreed to attend; additional participants were recruited from past participants of other sessions/surveys, via Craigslist, and via word of mouth from registered participants.

### Discussion of Goals

***Goal: Cultivate an Organizational Structure and Strategy Designed to Address the Future Multimodal Transportation Needs of All Texans.***

The goal is seen as lengthy and not completely clear. To the participants, it means: planning ahead, building an organization, talking about the future, thinking through projects, bureaucracy, committee, and left hand and right hand don't know what they're doing. Some see this goal as an internal goal for TxDOT, while others can see that it is intended for internal and external purposes. One person described the goal as communicating internally first, then going to the public. The wording of the goal is similar to the maintenance goal in that it sounds like nothing has been done in this area yet.

One participant told a story about contacting TxDOT about highway lighting. He spoke to a TxDOT employee who puts in the lamps for illumination. That person said that he didn't make the decisions and directed the participant to another employee who sent this participant back to the first. He went back and forth without resolution. The example points to the problem of accountability. "It's not my job" doesn't work when dealing with the public.

Re-wording this goal to something like, "Operate the department effectively and efficiently to address the travel needs of all Texans" received mixed reviews. Participants in Arlington and Brownwood liked the new wording, but participants in El Paso preferred the original wording of the goal. In either case, they recommended including present and future needs and ensuring that internal and external elements are included. Some said that internal and external goals should be separated. Another person chimed in saying, "Effective should read 'accountability' because if one guy messes up, the other guy should also be held accountable. You can't be effective without accountability." Heads nodded in agreement.

Discussion about this goal (Figure 3) got the Brownwood focus group participants talking about communication. Several indicated the need for a communication goal in the strategic plan.



**Figure 3. Goal: Effective Agency Organization.**

### Objectives

The first objective includes the development of a communication plan that fosters transparency. One participant said that transparency needs to be external, but it is written like an internal goal. The word, transparency is used so much that it raises concern. "Is there an issue with transparency? It is obvious from this goal that the department is not very transparent," said one person.

"Timely, accurate and understandable - I like these layman terms," said a participant. On time project design fits in with this goal and is very clear.

A participant stated, “Implement performance measures means getting more bang for the buck.”

### **Strategies**

The key communication role played by the solutions being offered was clear when the discussion turned to the example list of strategies. Comments such as the following were accompanied by statements such as “Now I’m starting to really understand what is going on.”

- “Examples are needed for the layperson.”
- “Keep it simple and write these at the 4<sup>th</sup> grade level.”
- “Need to be clear and succinct.”

When speaking about collaboration with local and regional communities and stakeholders, one person shared the need to take a holistic approach. He said that TxDOT needs to convince cities and counties to reduce urban sprawl, push toward green development, high rises, etc. When asked if he thinks this is the responsibility of TxDOT, he replied, “I think their mission should include convincing those who do land planning to stop allowing sprawl.”

### **Confusing Jargon**

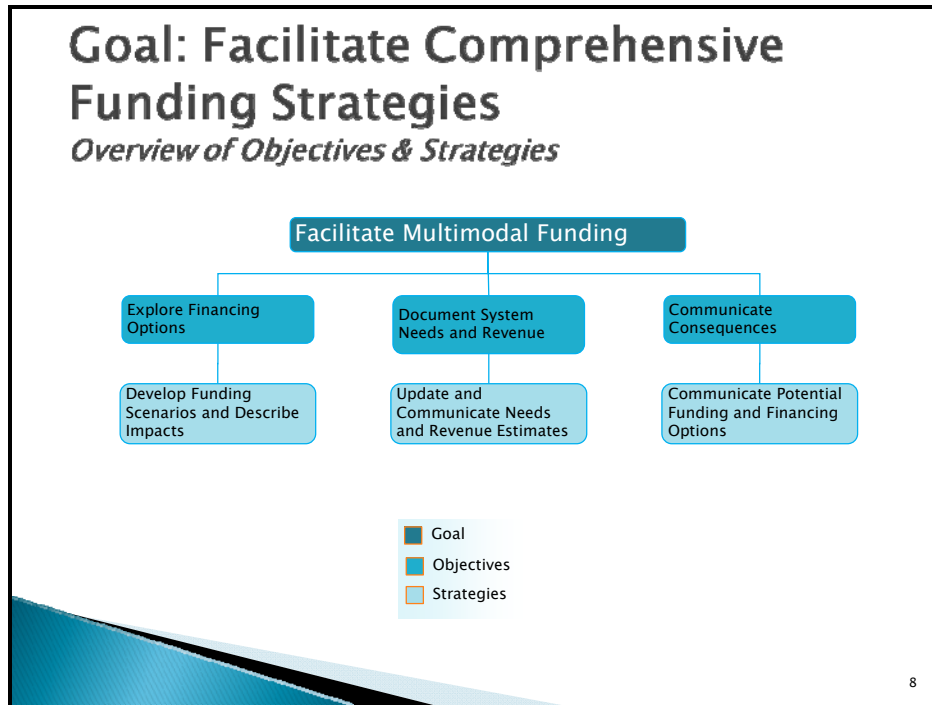
- Participants don’t know what Fund 6 is.
- What does “future” mean? – Participants suggested that TxDOT should convene a group to talk about the future transportation goals and needs.
- Partnership – Who is the partner? And how involved in the decision-making are they?

### ***Goal: Facilitate the Development and Exchange of Comprehensive Multimodal Funding Strategies with Transportation Program and Project Partners.***

The goal statement is confusing, too long, and filled with words that many participants did not understand. The focus group researchers developed an alternate goal wording that tested better, but a simpler version than the original goal must be used. Discussions of partners, programs, Fund 6, and funding scenarios did not fare much better. Participants wanted more information on who the partners were and what was included in the program, and were confused by “scenarios and impacts.” A strategy statement like “explore funding options” elicited much better response, and participants were in favor of those actions. “Fund 6” has no meaning to the general public.

The focus groups suggested public involvement in developing solutions and financing strategies. Greater involvement should lead to a more comprehensive set of strategies as well as more public support for the eventual plan.

A suggestion for improving the usefulness of the information developed in this goal was to also present data that compare the expected funding to the received revenue (Figure 4). This seemed like a logical element that TxDOT staff would want to have and, therefore, one that would not require much work to report to the public. Communicating the consequences of low or inadequate funding also appeared to be a useful element of any eventual financial strategy investigation.



**Figure 4. Goal: Facilitate Comprehensive Funding Strategies.**

### Objectives

Participants agreed that the financial objectives were appropriate and useful. Identifying financial options and estimating the amount of funding and needs were viewed as important elements of the financial solution. Creating estimates of the needs and revenues was seen as a basic element of the financial analysis. Identifying the consequences of the financial decisions was also seen as a valuable exercise.

### Strategies

Actions to create a variety of funding scenarios, need levels, and revenue estimates were viewed as good strategies to carry out the goal of identifying funding strategies. The analysis of options is necessary, and if proper documentation is provided and good communication methods are used, the information was seen as providing a much needed information base for discussions.

### Measures

The measures were viewed as a good combination of procedural elements (e.g., number of options) and descriptions of the results of the strategies (e.g., forecast accuracy and customer satisfaction). Both types of measures were seen as useful and valuable.

### Confusing Jargon

- Who are the partners? – There were many questions and some confusion expressed about the partners. Some participants assumed these were private sector toll road builders.
- What is Fund 6?

- “Development and exchange” does not add value or clarify meaning.
- “Multimodal” may be a useful term, but all projects should be included in “comprehensive” without the need for a multimodal label.

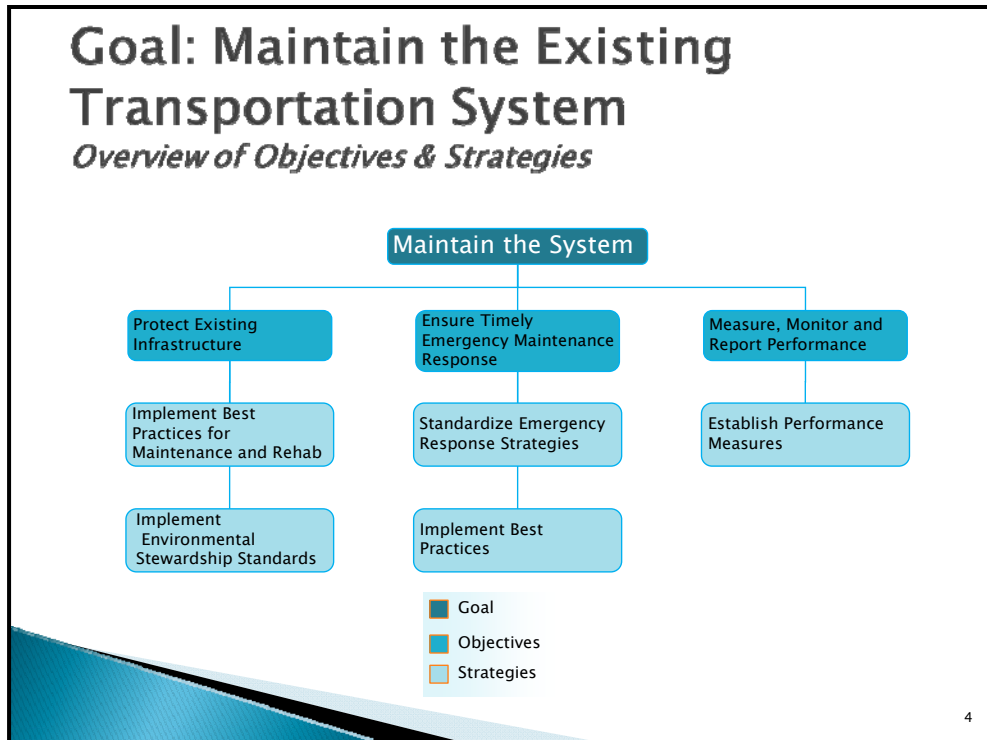
***Goal: Maintain the Existing Texas Transportation System.***

The focus groups generally understood the goal and measures used in the maintenance goal discussion (Figure 5). There was a preference for phrasing and focus such as “evaluate and improve the system.” This would indicate that any changes to the system were the product of study and that the goal is to improve conditions when possible. One participant said “I don’t want them to maintain the bad stuff.” “Keeping things up to date” was another way that their interests were expressed. Success would be seen when conditions are better after projects are completed.

Participants also wanted to know the current conditions and the methods used to measure and evaluate the system before they would agree that the goal and measures were reasonable. The use of terms such as “best practices,” “standards,” and “good” are either confusing or suspicious. Participants wanted to know who decides these terms, if there is any input from the public, and if the vagueness is a reflection of the fact that there are a lot of unknowns.

The “timely” wording is helpful in describing the goal and strategy. One participant suggested that maintenance is like brushing teeth: you don’t really see the benefit, but the situation is bad if you don’t do the action. There was also some confusion about what “system” the goal was referring to.

There seemed to be too many objectives for people to believe there would be adequate focus on the problems. Participants suggested a prioritized list of objectives might be appropriate. There also seemed to be some concern that innovations might not be pursued if “maintaining” were the goal rather than “improving” or “keeping conditions up to date.”



**Figure 5. Goal: Maintain the Existing Transportation System.**

### Objectives

The two objective topics appeared to cover the concerns of participants—regular maintenance and emergency or rapid response roadwork. The word “protect” was a concern of some participants who interpreted it as another word for “stagnant.” Performing the same functions with the same strategies would be supported, but the participants saw road maintenance in a more active role and one which seeks “improvement.”

Timely emergency response is an element of a complete program, but participants may have had a more expansive role for this topic. Roadwork, as well as crashes, vehicle breakdowns, weather emergencies, and other events, were words used to describe their understanding of timely emergency response. This input indicates that additional explanation is needed.

### Strategies

The phrase “best practices” sounds like the correct and appropriate term, but there is a concern about who defines the best and what effect that has on the project scale, budget, and cost effectiveness.

The other two strategies contain fuzzy words (e.g., stewardship and standardized) but generally were treated as good ideas. The connection between “standardized” and “good/best” was less clear to the participants; some effort should be made to ensure that the “standardized” procedures are as good as can be obtained.

## **Performance Measures**

Participants generally viewed both measures favorably, but the desire for more specifics was clearly present in the discussions about performance measures. The focus groups expressed a general wish that the measures be understandable and have explanations for terms and ratings wherever possible.

The focus on the condition of “lane-miles” seems out of step with a concern for people. Adding a measure of “percent of person travel on roads in good condition” would align the measure with the people concern and be supported by existing data sources. Shortening the emergency closure time is also a good outcome that would be identified with the example measure.

## **Confusing Jargon**

- What is a lane-mile? – While not a huge problem, there was some confusion.
- What does a “good” road look and ride like? – Any road condition description should use pictures to illustrate the quality of roads with different ratings. (As noted above, it is also easier to communicate road condition meaning if readers are given a map of pavement condition for roads they normally travel.)

## ***Goal: Promote Congestion Relief Strategies.***

Focus group participants understood the congestion goal statement and the desired outcome, but there was some confusion about whether multimodal strategies would be part of the solution (Figure 6). Most participants thought the multimodal aspect of congestion solutions should be highlighted in the strategies to show that road problems did not necessarily require road solutions.

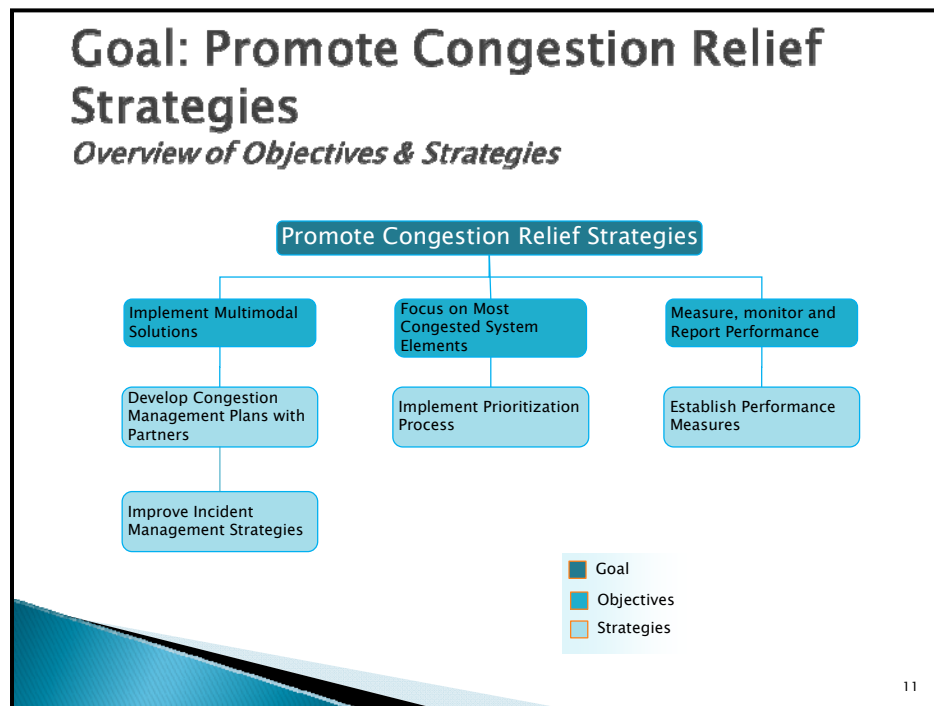
The Statewide Congestion Index measure sounds like the correct measure, and the short explanation (e.g., travel time compared to free-flow) resonated with all three audiences. Focusing improvements on the worst congestion was seen as a good scheme by most (even those in Brownwood who recognized that they don’t have a significant congestion problem). There was some concern that the funding might be channeled away from regions that had low congestion levels.

An aspect of congestion that did not seem to be represented is the annual trend. A word like “compare” should be added to the way the measures will be used such that there is a focus on changes as well as on the values. Regions or corridors that have moderate congestion but which are growing rapidly require attention to maintain a good operating condition and support a desirable quality-of-life.

Focus group participants wanted the congestion goal to refer to more than simply adding lanes on roads. They were expecting multimodal (their word in many cases) solutions that included clearing wrecks, timing traffic signals, developing innovative operating strategies (such as reversible lanes), increasing transit, and changing policies to encourage choices that are aligned with congestion reduction.

As with many of the goals, the participants wanted more information about the “partners,” specifically, who they were, what their role was, whether they would choose projects

and priorities, and the process for identifying and involving the partners. There was some concern that this was another way to describe another attempt at the Trans Texas Corridor.



**Figure 6. Goal: Promote Congestion Relief Strategies.**

### **Objectives**

Focusing on the most congested sections was viewed as sensible, although there was some concern about funding being disproportionately moved to large, very congested urban areas. Channeling funding to “problems” makes sense in general forms, and building on that expectation is a worthwhile element of the TxDOT plan.

### **Strategies**

The strategies were seen as connecting well with the objectives by examining a broad range of solutions from large to small, as well as improving the process by which projects are selected. There was some frustration with the jargon used, but rewording or providing more explanation should be effective in addressing that concern.

### **Measures**

The Statewide Congestion Index is not an inherently understandable measure, but it is easy to explain. The simple explanation (e.g., amount of extra time beyond travel time at free-flow conditions) was offered by one participant as a way to explain the measure. Focusing on the amount of funding used on the most congested road sections was also seen as a good measure.



## **Confusing Jargon**

As with other goals, the jargon confused some group members.

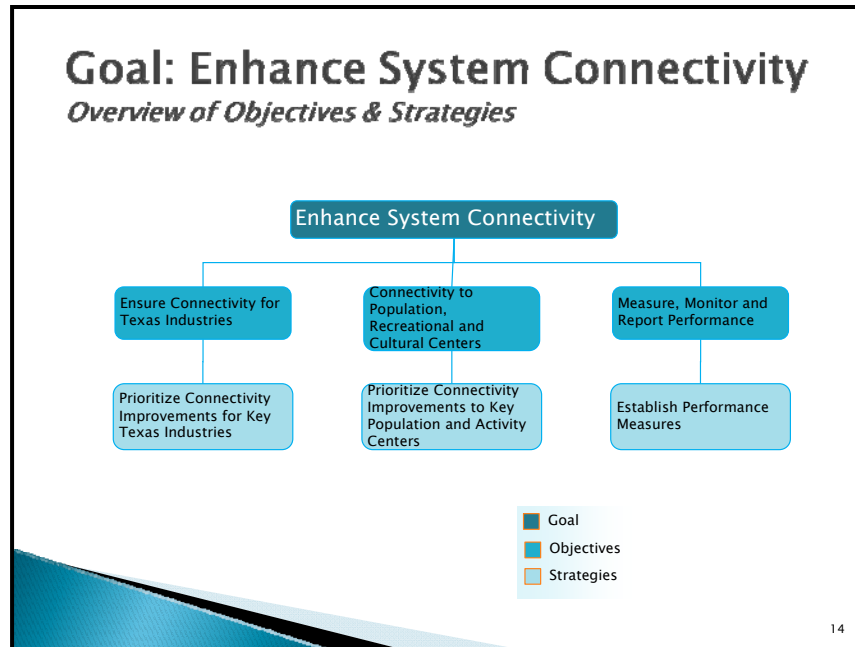
- Incidents – Use terms like crashes, collisions, and vehicle breakdowns, and discuss the congestion that is caused by these events.
- Prioritization process – This means choosing which projects to do first and focusing on the most important problems.
- What is a section? – Does the list include corridors, short segments, intersections, or some other geography?
- Why only 100 most congested sections? – Explain the rationale behind focusing on the top 100 sections and describe the type of roads that are included in the list.

### ***Goal: Enhance System Connectivity.***

On the whole, participants do not understand what “enhance system connectivity” means (Figure 7). There were many blank stares, silent faces, and wild guesses when asked what the goal signifies; better wording is needed. One person thought the goal is about better communication. Another said the goal is very vague. After they learned that it means providing transportation connections between populations, businesses, recreational areas, and cultural centers, several said that this is a good goal and that it just needs to be written clearer.

There were some disagreements with industries controlling location and access to new roads. Some viewed this goal as giving better treatment to private money donors. “Rich people get what they want,” one person said. Others offered a different opinion saying that more money is being generated for TxDOT when industries make location decisions and roadway connections are made.

When deciding where to locate, “it would be easier for Texas industries and population centers to plan communities where they can already be connected,” according to one participant. Another agreed, “Schools get built in the middle of nowhere, and five years later there are roads and houses all around it.” Several agreed, saying that TxDOT should work to re-build areas instead of creating new networks. They need to know that TxDOT is putting in connections where they are needed the most.



**Figure 7. Goal: Enhance System Connectivity.**

### Objectives

“These objectives are written from TxDOT’s perspective,” said one participant, who went on to say that TxDOT “has got” to monitor themselves. Ensuring Texas industries can efficiently access markets and gateways is a good objective because more money is generated for TxDOT when these connections are made. One person sees the performance measure (number of projects and money received from the private sector) as a way to minimize the amount of taxes needed.

Adding lane-miles to the state system must also include multimodal options. “We don’t want to just see roads to get somewhere – we want more modes,” said one. Others agreed, “bikes and bicycle lanes should be a part of connectivity.”

### Strategies

Under Objective 1, the strategies seem to indicate that TxDOT can be paid off to obtain better access; there are several mostly negative comments about these strategies. As for the strategies of the second objective (provide seamless, multimodal transportation facilities and networks to connect all statewide population, economic, recreational, and cultural centers), they were clearer but expressed a desire for a different performance measure—one that emphasizes the multimodal aspect.

### Confusing Jargon

- “Industry” is not clear.
- Who and what are “key” centers? This word sends an impression of exclusivity.

- The term “lane-miles” is tough to understand. One thought a more meaningful measure would be the time required for travel.

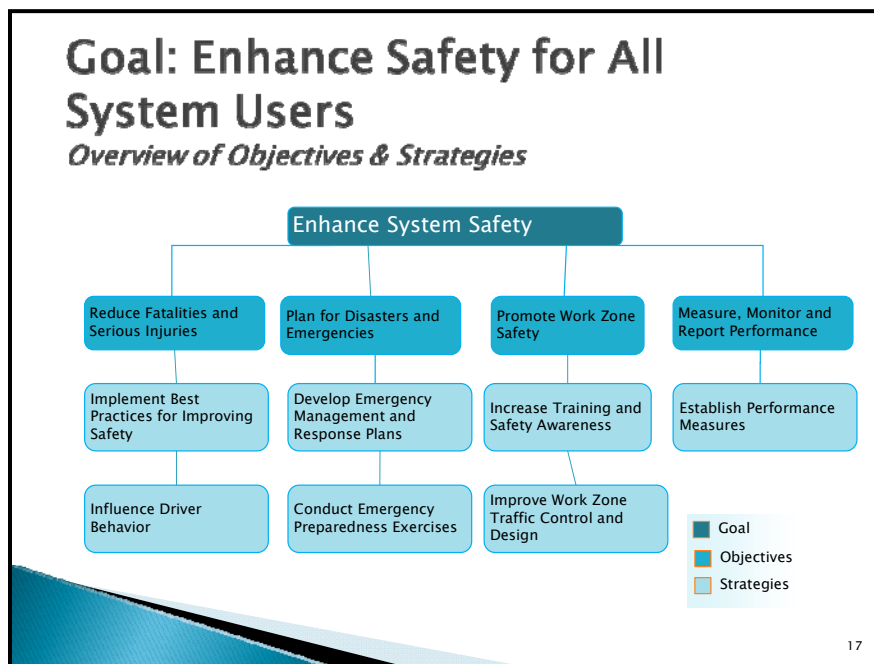
***Goal: Enhance Safety for All Texas Transportation System Users.***

Focus group participants understand the importance of safety on the transportation system. In each of the three focus groups, this goal was ranked 1<sup>st</sup> or 2<sup>nd</sup> in importance. They recognize that safety relates to maintenance, congestion, and economic vitality. For example, when the roadway is not maintained adequately, potholes may form and increase the chances for crashes. Signs, markings, and signals also need to be maintained to avoid confusion and resulting crashes.

In terms of the wording of the goal, they like that TxDOT recognizes the need to improve safety. As such, they agree with the word “enhance” as a sign of striving to do more (Figure 8). However, “enhance” doesn’t show that TxDOT has done anything in the past to improve safety. There is missing information about how safety will be judged. For example, one participant asked, “Who is rating safety and what is considered good?” They want to know how they can tell if TxDOT is reaching their goal.

Several expressed the desire to track not only serious injury crashes and fatalities but also “non-serious” collisions. Getting driver feedback on safety issues was suggested as a way to ensure safety is being addressed. Some have been involved in near crashes and would like to have a mechanism to share potential problems before serious crashes occur. They requested a hotline or a 3-1-1 system where they can report the concern.

They recognize the need for comparisons in order to understand rating systems. Including historic data as well as information from other states would be helpful. They expressed the need for more specifics.



**Figure 8. Goal: Enhance Safety for All System Users.**

## **Objectives**

Reducing fatalities and serious injuries is a good objective and should go further to include all crashes and potential crashes. The performance measure example provided is the number of fatalities per 100,000,000 miles traveled. They'd like to see more than traffic deaths in the performance measure.

Objective 2 pertains to planning for, coordinating, and responding to disasters and emergencies. The example performance measure is the evaluation rating of TxDOT disaster response strategies/readiness. This performance measure sounds like an in-house measure and doesn't mean anything to the participants. They suggested bringing the public into the plan. Having some perspective or rating system to understand the measurement would be helpful.

Some people asked about the importance of work zone safety. Work zone safety is seen as the responsibility of the driver and the worker. Both parties need training. One person suggested an extra defensive driving class on conducting yourself in work zones. Another asked if the driver or worker was at fault in crashes, and to focus education on the appropriate people. Also mentioned, if nobody is seen working, motorists may not slow down in the work zone. One suggested signs that say, "Slow Down. My mommy and daddy work here" for work zones in Texas.

Since safety is such an important goal, several liked the idea of performance reporting to let the public know about how the Department is doing. A couple of people said that reporting should be done monthly, especially if doing so doesn't hit the budget too hard.

## **Strategies**

One example strategy listed in the plan is to influence driver behavior by supporting safety outreach programs. A few of those in attendance questioned the ability of TxDOT to influence driver behavior.

Training is seen as a critical element for responding to disasters and emergencies. As such, they agreed with the strategy of conducting exercises to practice a response plan.

## **Measures**

In terms of measuring, monitoring, and reporting performance in improving safety, they said that local information would be helpful, especially using an online map. They'd like to know the scale so that they understand what is good and can compare to see if TxDOT is reaching their goal. Having the information readily available not only online but also available to the driver is desired. However, when questioned if they would seek out this type of information, most said no. The one who said she would seek information said that she tried to locate safety data using the TxDOT website after witnessing several crashes at one location.

## **Confusing Jargon**

- Defining 100 million vehicle-miles traveled is important since most of the focus group participants are unaware of the term.
- What does "promote" work zone safety mean?

## Vote Results on Six Goals

A vote sheet was provided to each of the participants. They were asked to rank the goals most to least important (with 1 being the most important and 6 being the least important). In Arlington and El Paso, the focus groups were asked to vote before and after the discussion. The results have been averaged and ranked based on the average score. As seen in Tables 14, 15, and 16, the key findings are:

- Safety was ranked most important (1<sup>st</sup> or 2<sup>nd</sup> on average in every focus group). Arlington participants ranked congestion higher than safety, while Brownwood and El Paso placed a higher importance on safety.
- Congestion Relief was 2<sup>nd</sup> most important (1<sup>st</sup>, 2<sup>nd</sup>, or 3<sup>rd</sup> on average in every focus group).
- Facilitate Development of Multimodal Funding Strategies goal placed last in every ranking (6<sup>th</sup> place).
- Organizational Structure goal was near the bottom of the list (4<sup>th</sup> or 5<sup>th</sup> on average in every focus group).
- When before/after voting occurred in Arlington and El Paso, the votes did not change significantly on average, though some participants did make significant changes to their vote.

**Table 14. Brownwood Focus Group Vote Results.**

| Vote on Strategic Goal Priority - 2/08/2010 |             |   |   |    |   |   |   |   |         |      |
|---|-------------|---|---|----|---|---|---|---|---------|------|
| Goal  | Participant |   |   |    |   |   |   |   | Average | Rank |
|   | A           | B | C | D* | E | F | G | H |         |      |
| Organizational Structure                    | 4           | 4 | 4 | 1  | 6 | 2 | 1 | 4 | 3.3     | 5    |
| Funding Strategies                          | 6           | 5 | 5 | 1  | 5 | 3 | 4 | 3 | 4.0     | 6    |
| Maintain the System                         | 3           | 1 | 5 | 1  | 2 | 2 | 5 | 1 | 2.5     | 3    |
| Congestion Relief Strategies                | 1           | 2 | 1 | 1  | 3 | 1 | 2 | 2 | 1.6     | 2    |
| Enhance System Connectivity                 | 5           | 3 | 3 | 1  | 4 | 1 | 3 | 1 | 2.6     | 4    |
| Enhance Safety                              | 1           | 1 | 2 | 1  | 1 | 1 | 1 | 1 | 1.1     | 1    |

\* Participant said, “Working together through every facet of the Department, I think they should all be equally important and time given to each.”

**Table 15. Arlington Focus Group Vote Results.**

| Vote on Strategic Goal Priority - 2/22/2010 |                                       |     |     |     |     |     |     |     |     |         |      |
|---|---------------------------------------|-----|-----|-----|-----|-----|-----|-----|-----|---------|------|
| Goal  | Participant - Before/After Discussion |     |     |     |     |     |     |     |     | Average | Rank |
|   | A                                     | B   | C   | D   | E   | F   | G   | H   | I   |         |      |
| Organizational Structure                    | 3/6                                   | 1/6 | 6/6 | 4/4 | 5/6 | 4/4 | 6/6 | 4/4 | 2/1 | 3.9/4.8 | 4/5  |
| Funding Strategies                          | 5/5                                   | 4/4 | 4/4 | 6/5 | 3/5 | 3/5 | 5/5 | 6/6 | 3/6 | 4.3/5.0 | 6/6  |
| Maintain the System                         | 6/3                                   | 6/3 | 2/2 | 3/6 | 4/4 | 6/6 | 4/4 | 5/5 | 1/2 | 4.1/3.9 | 5/4  |
| Congestion Relief Strategies                | 1/1                                   | 5/2 | 1/1 | 2/3 | 2/2 | 1/1 | 2/2 | 2/2 | 6/2 | 2.4/1.9 | 1/1  |
| Enhance System Connectivity                 | 2/2                                   | 2/5 | 5/5 | 5/1 | /1  | 5/3 | 3/3 | 1/1 | 4/4 | 3.4/2.8 | 3/3  |
| Enhance Safety                              | 4/4                                   | 3/1 | 3/3 | 1/2 | 1/3 | 2/2 | 1/1 | 3/3 | 5/5 | 2.6/2.7 | 2/2  |

*Participants ranked the strategic goals before and after discussion (x/y = before/after)*

**Table 16. El Paso Focus Group Vote Results.**

| Vote on Strategic Goal Priority - 3/03/2010 |                                       |     |     |     |     |     |     |     |     |     |         |      |
|---|---------------------------------------|-----|-----|-----|-----|-----|-----|-----|-----|-----|---------|------|
| Goal  | Participant - Before/After Discussion |     |     |     |     |     |     |     |     |     | Average | Rank |
|   | A                                     | B   | C   | D   | E   | F   | G   | H   | I   | J   |         |      |
| Organizational Structure                    | 5/5                                   | 2/2 | 6/5 | 5/2 | 6/6 | 3/3 | 1/1 | 4/6 | 3/4 | 4/3 | 3.9/3.7 | 4/4  |
| Funding Strategies                          | 6/6                                   | 4/5 | 5/6 | 3/3 | 5/5 | 4/4 | 3/3 | 6/4 | 6/6 | 5/5 | 4.7/4.7 | 6/6  |
| Maintain the System                         | 4/3                                   | 1/1 | 2/1 | 1/1 | 2/2 | 6/6 | 6/4 | 2/2 | 5/3 | 6/6 | 3.5/2.9 | 3/2  |
| Congestion Relief Strategies                | 1/2                                   | 5/6 | 3/3 | 4/5 | 3/3 | 1/1 | 5/5 | 3/5 | 1/2 | 1/2 | 2.7/3.4 | 2/3  |
| Enhance System Connectivity                 | 3/4                                   | 6/4 | 4/4 | 2/4 | 4/4 | 5/5 | 4/2 | 5/3 | 4/5 | 3/4 | 4.0/3.9 | 5/5  |
| Enhance Safety                              | 2/1                                   | 3/3 | 1/2 | 6/6 | 1/1 | 2/2 | 2/6 | 1/1 | 2/1 | 2/1 | 2.2/2.4 | 1/1  |

*Participants ranked the strategic goals before and after discussion (x/y = before/after)*

## Conclusions

Focus group participants supported all six goals, once the meaning of each goal was clarified. The focus groups all appreciated TxDOT’s interest in the public’s reaction to the goals and suggested several aspects that could improve the final version of the plan. Interestingly, there was less variation between the responses of the three focus groups—conducted in Arlington, Brownwood, and El Paso—than one might expect.

Jargon and technical terms, while necessary for some performance measures, were clearly a barrier to more engagement, but participants indicated an interest in using the information that would be produced. It wouldn’t be mandatory late-night reading material, but they liked the idea that they would be able to find the information they wanted. They also referred to a linkage between having the data available for public viewing and increasing the trust they placed in TxDOT. Participants recognized that there was a cost to collecting data and producing information but felt that if TxDOT staff was using the data, a website could be frequently updated for the public as well.

In the technical information portion of the plan, there was a substantial interest in seeing multimodal solutions and strategies. The idea of a comprehensive set of strategies was not just limited to the large metro focus group. The groups expected to see performance measures that would allow them to compare with targets or goals, but they were also interested in trend information. Answering the “how are we doing?” question is just the first step for these readers. “Are we getting better or worse?,” “how quickly are we changing?,” and “what does the future look like?” are three other questions that TxDOT should be prepared to address.

When asked to rank the goals in priority order, participants in all three groups ranked safety and congestion as their two top priorities. Regional connectivity and maintenance were, on average, the next two priorities, and funding and organizational structure the final two. One way to understand these rankings is to characterize the first two goals as “direct service received by travelers,” the next two as “making travel easier,” and the final two as relating to how the first four goals are produced. It would be incorrect to suggest that the participants thought funding and organizational structure were not important; rather their concerns focused on the most tangible elements.

## **Recommendations**

Perhaps the most important element for plan designers and those who will be tasked in following years with reporting and communication duties is that the participants were much more engaged and interested when they were able to see how the goal, objective, strategy, or performance measure related to roads they travel. Several times during the discussions a participant would refer to the need for a map or display showing the condition or performance of a local road in relation to a term such as “good condition” or “congested” or “safe.” To the extent possible, providing the public with such a local view allows them to understand the more conceptual terms used in the plan.

Providing layman’s terms or defining confusing jargon is important for connecting with the public and helping them understand the various elements of the plan. If the confusing term cannot be removed or softened, a glossary, links, or call boxes can be used to explain the meaning of the word.

The focus groups suggested that TxDOT develop a prioritized list in several cases where there were multiple items; they recognized that funding is tight and that “everything cannot be a #1 priority.” A prioritized list might also have the advantage of continuing the public discussion of transportation issues, which is something else the participants requested. They would like to see a contact person, email address, phone number, etc., for all elements of the plan and supporting information. The presence of a hotline phone number or “hot link” from a website is ubiquitous on internet sites, and TxDOT was encouraged to follow that trend.

## APPENDIX A: NOTES FOR EACH FOCUS GROUP

### Dashboard Phase III Brownwood Focus Group February 8, 2010

Almost everyone indicated that they had read the Strategic Plan.

*What did you think of TxDOT's proposed Strategic Plan?*

Several say it was easy to understand, clear. It seemed like it addressed important issues, I saw some points from the ideas we brought up this summer. But it was technical; not real clear on what it means for me.

From your read, can you say what TxDOT's top three goals are? Safer roads, emergency vehicles arriving quickly, finishing projects, general overview of TxDOT and what they do, finance options

What is not in the plan, but should be? Can't think of anything. "It was very organized, pretty self-explanatory."

One thing they should do before messing up roads is get community leaders together. Will it work or not? Like medians on Commerce....communication to provide rationale for the project. Coming down Bangs Hill, wants to go to Sonic, but there is a median there. Need to have U-turns to make it more convenient to go to Sonic and other businesses. What was the purpose for that median in Brownwood? I heard about an older person who forgot it was there and hit the median. It is unclear whether U-turns are allowed. Input from the community might have avoided this problem. At least we would have understood why they are doing the project.

#### **Goal: Maintenance.**

What does this mean? Keep it updated. Keep it from degrading. Prefer the words, "Evaluate and improve the existing system." One question about maintenance...I don't want them to maintain the bad stuff like the flooding problem on 3<sup>rd</sup> Street. "I like the words in the plan."

What would indicate success for this goal of maintenance? The system doesn't deteriorate. When the project is done, things are better. The way traffic flows can indicate success. Can determine by accidents. Can get from A to B safely.

I need to know the threshold for the performance measurement before I say if I think it is reasonable. Like need to know a number of hours of duration that a road is closed.

How would you get someone to fix the roads? I live on a dirt road which floods and I cannot get out.

"Timely" wording is helpful.

"I like making this public."

Would you read something like this? Yes! We would read it. What format? Newspaper, web (nodding heads when mentioned online). What we need is a way to provide feedback if we agree/disagree with a rating or feature. Need an email link or phone number.



Condition rating of good or better. What does “good” mean? Examples of good or better online would be nice...especially in a map format where you can see a roadway’s rating. Truck drivers need to know this information.

I’d like to see what they are calling “good.” I might say, “That’s not good.” What might be a good road for an SUV might not be good for my Mustang.

**Goal: Safety.**

What does this mean? Keeping everyone safe, planning ahead...like in disaster emergencies, letting you know what’s ahead of you. Watch out.

“Contingency plan for disasters”

How is life better with this goal? Safer. The vehicles would be safer...we won’t have busted shocks or need to have maintenance done. Reduced fatalities and serious injuries. This goal sounds like we haven’t done anything in the past. Let the public know it is being practiced.

“Those are good strategies.”

Work zones may not be clear by the end of the day. Night time concerns. Way too dark.

Workers and drivers need training for work zones. Extra defensive driving class on conducting yourself in work zones.

How do we judge safety? Crashes, fatalities.

Local information on safety would be helpful...map example again; an online map with colors for safety rating.

“Who is rating it?” What’s good? Need a scale and to see comparisons. Are we reaching our goal?

Are crashes in work zones the fault of the driver or the worker? Use the results to educate the appropriate person.

Need another measure to use instead of fatalities/serious crashes. Like driver feedback maybe through reporting on a hotline or texting. “A lot of people don’t know who to talk to.”

It’d be good to have a 311 system to report non-emergency issues.

Also would be good to have a specific number to call for the project itself.

**Goal: Connectivity.**

Nobody knows what that means. Turnarounds, support big industries. Several guesses. This goal is vague. TTI researcher explained what connectivity means.

Industries that give TxDOT the most money have better roads. You get what you pay for. Better treatment for private money donors.

Lane-mile is not understood.

“Just putting in more miles when not needed...that’s not good.” Need to know that they are putting in connections where needed the most. Where are they putting them? Key to whom?

The added lane may not be needed.

### **Goal: Congestion relief.**

They understand this goal. Missouri DOT does a good job getting sand on snowy/icy roads to decrease congestion during weather problems.

This goal means putting more lanes on the highway to reduce drive time, gas, and road rage.

Implement multimodal solutions...what does this mean?

Focus on most congested roads...yes, they understand.

Who are the partners?

Improving incident management strategies...what does this mean? They don't know. After explanation, they ask why the goal doesn't say cleaning up quickly after crashes. Seems like big, unnecessary words.

Prioritization process – yes that makes sense (once they understood that meant choosing which projects to do first).

Statewide congestion index – yes, that makes sense.

When asked about the statewide congestion index, participants say they don't know what it means. Where would you want to see the congestion index? On the roads I drive...want to see a map so I can look at my area. Individualize the roadway network.

Add “Compare” statewide congestion index from year to year to see trends...need action word there.

Yes, they know what 100 most congested segments means, and they know Brownwood isn't on the list.

### **Goal: Facilitate Funding Strategies.**

“Wow!” It seems like someone pulled out a thesaurus and used the biggest words.

Second version of wording is better than original wording of the goal. “Facilitate comprehensive funding strategies with transportation program and project partners.”

Transportation program and project partners – unknown what/who these are.

Develop funding scenarios and describe impacts. Blank faces. “Explore funding options” is better.

“Cause and effect” is what impact means.

Document system needs and revenue seems to be more defined. Nodding – supports the objective, “needs more info” though.

Who are they communicating to? Consequences – says what happens. We're going to improve roads, here is what problems develop (some grimaces at the word “consequences” – they said it sounded ominous & appeared uncomfortable; they understand the concept).

Performance measure.

“What's a stakeholder?”

Does the number mean anything to you? Need to compare, says one participant.

Yes, the performance measurement supports the objective.

Fund 6 – what is that? TTI described that Fund 6 is where the taxes you pay on gas and vehicle registration goes...the main funding source for TxDOT.

Need a comparison of before to actual (planning and forecast). Described as “compare what you got to what you thought you were going to get.”

What is the need?

I like “understandable information.”

Why do we have to evaluate timeliness...basically just want to know what customer surveys say.

“Don’t let the same people write that that wrote this.”

### **Goal: Organizational Structure.**

They think it says to come up with a plan for future needs. Need to think through projects right now also. Organizational structure = Bureaucracy, committee. Left hand and right hand don’t know what they’re doing.

This goal talks about future, but also need a goal to evaluate current organization. Do it better now and later. Transparency – needs to be external, but the strategy is written like it is only internal.

“Communicate internally first to then come to us.”

Facilitator: should there be a communication goal? Yes! But how do you communicate with 23 million Texans?

Implement performance measurement programs – means more bang for the buck.

Which one is more important at the time?

What will increase the performance? Which can be done quicker?

Who are the stakeholders? Not clear on implement performance management program.

Develop and nurture partnerships. “Nurture” is a confusing term, but partnerships are good. Corporate knowledge transfer – the top of company. Good communication top down. Mentoring, training, salaries – good.

Foster transportation through communication performance measurement – Timely, accurate, and understandable – I like these layman terms.

On time – yes; timely fits in with goal.

Partnerships are good but who is the partner? Employee retention – good.

Do some of these goals make more sense than others? Yes! Do some need to be re-worked? Yes!

**Dashboard Phase III  
Arlington Focus Group  
February 22, 2010**

**Was the Plan clear? Did you understand?**

No, not clear, redundant, lawyer speak

It would be wise to have some details (meat/potatoes).

Seems like mission, objective, measures don't connect (like one person did each one).

Hard to understand, no clear explanation of what they're going to do.

**What did you think of the Plan?**

Not clear strategies, no examples, too broad.

Needs a "how to" or responsibilities list.

No real connection for real people and solve real problems.

**Goal: Maintain.**

What's it mean? Keep it up to date (a few said this) – this is what they want it to say.

Keep it the same - more said this.

Repair potholes.

TxDOT doesn't want to improve or expand.

Not clear on what "transportation system" it applies to.

Status quo – sounds like we're not going into future. The goal needs a definition, needs to clearly say "We're going to keep things up to date."

**Objectives**

Need to be prioritized. Where are the biggest problems?

"Timely" – priority, emergency – but experience is that they take forever to fix infrastructure.

**Strategies**

They want more information on these.

Performance measures tell you what objectives and strategies mean.

Would like to know what the definitions of thresholds are.

Measure, monitor – should use this to prioritize.

Where's money spent?

One participant noted this phrase was used a lot "Identify, Define, and Implement Performance Measures."

Accountability – information should be local and should be mapped; want to see what the pay off and results are. They want the plan and results to be user-friendly; use maps, color, info on "my

roads.” We paid for the roads, we should be able to get the info. Also good if we want to relocate to another area.

### **Goal: Safety.**

They say this means roads, signals, signs, maintained in good working order.

Addressing problem areas of high crash rates.

We should always try to “enhance” safety. “Enhance” is up one level from “maintain” (it’s better).

Signs especially need improvement – bigger signs.

Why not include “non-serious injuries” – no sure what this means or why only “serious” crashes are included.

“Promote” work zone safety – what does that mean?

“Influence behavior” - how would you do that?

Real-time stuff is good.

Can’t see their ideas in the safety plan.

Not clear – what is 100 million vehicle-miles.

Report more often if it’s not going to hit budget too hard (maybe monthly).

Safety is important, so maybe report more often than some other issues (e.g., monthly).

Not just deaths, want injuries reported. This was interesting. They want every little thing reported.

Can’t judge “Evaluation Rating” until we know what the standard evaluation is.

Want comparisons – historic, other states, pictures, how rating gets done.

### **Goal: System Connectivity.**

Clear-ish to some; Most say need better wording – don’t understand.

Enhance Multimodal System Connectivity – is what they think it should say and what they think it is.

Point A to Point B is what this is about; signs to help understand.

Smoothly getting across town.

Texas “industry” – worst word - don’t know what “industry” is included or not included. And what is key – didn’t like the word “key” – sends the wrong impression.

Population, Recreation, Culture – this is good.

Industry means - “Commerce” “Businesses” “Commercial Areas.”

Must be both highways and multimodal.

### **Strategies**

It means – “Can pay off to get better access” and “Rich people can get what they want.”

(is parking a part of the system?)

“Key” is too fuzzy – who is “Key.”

Lane-miles – tough to understand.

Lane-miles aren’t it – we really want “time to get there.”

Don’t want to just see roads to get somewhere – want more modes.

Bikes and bike lanes – this is also connectivity.

**Goal: Congestion Relief Strategies.**

Point A to Point B as fast as they can get there.

Clear wrecks as fast as possible.

“Promote” means advertise.

“Promote” means make better, awareness, improve.

Add more lanes, signal lights synchronized.

“Multimodal” – good concept!

Focus on most congested – good.

Partners? They want to know who the partners are.

Incident Management – need same good training for all agencies (not just DPS).

Statewide Congestion Index – don’t know what the term is; vague, not sure.

If it takes me 15 minutes without traffic and 60 minutes with traffic that’s congested.

% of funding for most congested – like to see where roads are because want to drive from pt A – pt B.

More info means TxDOT looks like they have less to hide.

**Goal: Multimodal Funding.**

Tie everything together for funding.

2<sup>nd</sup> goal statement “Facilitate Comprehensive Funding Strategies with Transportation Program and Project Partners” is better.

Thought we are talking about both transportation and funding.

2<sup>nd</sup> says just funding.

They don’t realize this was about funding. They just keyed in on multimodal.

Options are good.

Document needs – how much revenue and what is cost.

**Performance Measure**

Just because you look at options does not mean you get anything.

Fund 6 – what is this?

Customer Satisfaction – very good.

**Goal: Organizational Structure.**

Get a group together to talk about future. What does “future” mean?

2<sup>nd</sup> is better “Operate the Department Effectively and Efficiently to address the Travel Needs of All Texans” - but need to “Address the present and future needs.”

Looks like this is the same as “maintain” goal.

They didn’t get the meaning – they think we need an internal AND external element.

Objectives and strategies sound both internal and external.

Effective Agency – should support other goals.

**Performance measure**

“on-time design” is very clear.

Customer satisfaction – hard to do.

Partner relationships – easy to understand.

**Dashboard Phase III  
El Paso Focus Group  
March 3, 2010**

Facilitator asked whether those who participated last time recognized some of the goals.

Yes, I remember maintenance and congestion was discussed last time and I see it is on TxDOT’s list of goals. We did talk about buses and trains as I recall.

When asked if goals make sense, several said no. Facilitate Development and Exchange of Comprehensive Multimodal Funding Strategies with Transportation Program and Project Partners seems incredibly vague to me. Coordination goal is also vague. What does multimodal mean? Another participant answered – able to use multiple modes.

Facilitator – Based on the strategic plan, what are TxDOT’s top 3 goals?

Responses:

- road and rail
- safety of intercity – growing population
- road maintenance
- connectivity
- highways (goods movement)
- want to find innovative ways of funding
- communicate openly and honestly (participant went on to say that if you communicate in short bits and pieces, the listener gets the wrong message)

- transparency came up over and over. It is unusual to see that everywhere and left me asking why?
- Provide best value – how will they do that? Is it part of the old good old boy system?
- Big impetus toward new additions
- I think that transparency was misread. Right now they are opaque and are trying to make it open and see through. Maybe they are using the term to make change
- Encouraging public participation

**Goal: Maintain Existing Texas Transportation System.**

This goal says to me that TxDOT will not increase any service and instead will keep whatever service currently exists. Maintain means keep what's in place in place and don't take away. Several agree – they don't like the word maintain. There are huge stretches that desperately need repair. You got to have a benchmark. Maintenance equates with finance. Which roads get maintained first should be contingent on the volume of cars.

Need to think about improvement. Bus system has to be expanded.

They should change their thinking and do things that are more effective.

Facilitator – How does it improve your life if they are maintaining the system?

The way it is written now doesn't change or improve my life. Maintenance is not needed....drastic improvement is needed.

I look at it in the positive way in that if you don't maintain the roads, then my life will get worse. It is like brushing teeth. I do it to maintain and if I don't then my teeth will decay which will eventually make my life worse.

TxDOT has to grow with the population. Additional signs, digital signs, interstate signs like “crash up ahead” is great! I love seeing the interstate signs on the ground because I know where I am. Those are important TxDOT functions. These signs do a better job to ensure safety.

Objectives – Do you understand what all of these are? Yes, foundation for the rest. Do you know what ensure timely emergency response means? Yes.

I'll say that better utilization of existing resources should be there. Why are there so many semi-tractor trailers when we have rail systems? Need to ship on rail. For transit, infrastructure needed. Bicycle lanes, bus lanes, schedules, monorail all needed. Also need to complete the loop and the parkway needs to be done! The roads can't handle existing traffic. However, building more highways brings more traffic.

Implement Environmental Stewardship Standards means adding solar powered signs, don't mess with Texas campaign, car maintenance signs.

Facilitator – Do these objectives relate to maintenance? Yes, water damage to roadways. Icy overpasses exist - there were no signs from TxDOT to close the road. Another participant – environmental stewardship doesn't seem to link to weather. These objectives aren't defined. We are reaching at straws.

Example Performance Measure – means that the jury is still out. They don't know what performance measures to select.



Implement Best Practices does not make sense to one participant. Who decides what is best? It is too subjective. Another explains that best practices come from research.

Facilitator – We will measure whether we are protecting our infrastructure by % of lane miles on the state hwy system that is rated good or better. Do you know what good or better means? In my mind it means that surveyors calculate the pavement rating against agency established standards.

Do you want or need to know what good is? Yes, I would like to know. Need a key. Good could mean one thing to me and another to the TxDOT surveyor. Footnotes are needed to define good.

Let's have billboards, let's have a hotline to report road conditions. Agreement on the hotline idea.

Good or better should include what braking is available on a good road. Pavement condition rating should change based on weather. If a truck is going to jack knife due to weather, wouldn't that driver better negotiate speed if they knew what was ahead? The public needs to know. Drivers need to know. We want to know the pavement condition rating. Maybe a number, picture, more material should be included to explain the pavement condition rating.

Facilitator – What is a lane-mile? One person knows. Do you need to know what the term means? Yes.

As long as we know what that percentage is maybe we don't need to know what a lane-mile is.

Facilitator – so it doesn't really matter if you measure it as long as you have a percent...is that right? That is not right. They want to know what the scale is. To one it matters knowing what a lane-mile is. Sometimes when you are driving on a road with two lanes, one lane could be good and another bad but you can only say 100% good or 100% bad.

TxDOT isn't setting the goal very high when all they are worrying about is pavement structure. How about lighting, visibility, etc.?

Quarterly publication performance measure:

Billboards – good idea. Yes, I understand quarterly publications. Will everyone get a copy of it though? I think they should place them at bus terminals, libraries, etc.

People respond to positive reinforcement. They should encourage good behavior.

When asked if they would seek out this information, all except one participant would not seek out this publication. The one who would seek it out viewed several accidents at one location.

**Goal: Safety.**

Means making sure there are no crashes, no potholes where people will veer off the road.

You can only have so much of an effect. What if I am not the one driving the car?

Objective of reducing serious fatalities and injuries – it is fair to say that it is appropriate.

Planning for disasters and emergencies? Training, training, training. Yes, makes sense.

For work zone safety, how important is that Really? It has to do with the wait when workers are working. If you can't see anyone working then you may not slow down.

Facilitator – does the objective address the goal? Driver behavior should be at the top of the list. It is the driver that makes the decisions. If you influence driver behavior will you achieve the objective? Yes.

Again I think best practices is incredibly subjective. Completely disagree with implementing best practices.

TxDOT needs to bring the public into the plan for emergency preparedness.

Facilitator – performance measure – reduction of fatalities and injuries by crashes per 100 million miles traveled. Do you know what that means? “From here to the moon I guess.” More than one person doesn’t know. A couple try to explain.

Are we shooting for zero fatalities? Is it important to know. Yes, it would help. Need plain language for general public. Put it online and electronic billboards. Awareness is the first thing to do. Put information on the web most helpful. Do a campaign to let the public know. To me a quarterly report is nice, but I want it on the roads while I am driving.

Need to change thinking to get desired result.

Evaluation Rating Disaster – in-house measure doesn’t sound like anything for us. Need to know where you are going to send traffic if tornado or something comes.

Disaster relief readiness – evacuation plan, what is most economic route to get around town.

### **Goal: Enhance System Connectivity.**

Means communication between TxDOT and everyone else that involves TxDOT. No one understands what this goal means.

Facilitator explained – This goal means transportation of goods and services across the state. Getting from point A to point B and communication are two different things.

This is a good objective – more money being generated for TxDOT when connecting Texas Industries.

Easier for Tx Industries and Population Centers to plan communities where they can already be connected. Schools get built in middle of nowhere. Now roads, neighborhoods are all around it.

Facilitator – Performance measure for ensuring connections for Tx Industries – TxDOT will measure the number of projects and money received. I see this as money from taxes. These objectives are written from TxDOT’s perspective. It is presumptuous to expect businesses to pay. What about our taxes?

I read that as how much money is being generated based on the movement of goods and services. Need to get private money so that we can minimize the amount of taxes needed.

Several don’t know what lane-miles means. Who decides who is key?

### **Goal: Congestion Relief Strategies.**

Dallas is awful. Need to reverse lanes, get us out of congestion, have a functional transit system. You promote better flow of travel when you provide options.

Facilitator – Implement multimodal solutions – what does this mean? It means different methods for getting places.

Participants don't know who our partners are.

Facilitator – Does improving incident management strategies mean anything? One participant says it means improving the line of communication between jurisdictions. They'd like to know what it means.

Facilitator – Implementing prioritization process – what does this mean? Need to improve communication so they can address incidents. Public needs to know what the prioritization process is.

Statewide congestion index (SCI) is the performance measurement. Do you need to know what this is? One says that this means that TxDOT will funnel more \$ away from El Paso because more populated areas will rank higher. Shouldn't base it on SCI for this reason...instead distribute geographically.

SCI better on most congested system instead of multimodal objective.

Percentage of funding allocated to the most 100 congested segments – do you know what that means? One answers, first you do your SCI and rank the first 100.

Is the SCI based on population? What is the definition of the SCI? One would like the definition. What if they are all in Dallas? What is a segment? A footnote would be appropriate.

Some uncertainty of what TxDOT maintains...facilitator explained that interstates and highways are all maintained by TxDOT.

What bothers me about this is that it is really broad. Are they talking about interstate, inside or outside of the city, why just 100 congested segments?

### **Goal: Facilitate Comprehensive Multimodal Funding Strategies.**

Blank stares from participants. What if we said something like the next slide, "Facilitate comprehensive funding strategies with transportation program and project partners?" It gets rid of multimodal. Answer is not clear. Who are the partners? Why does comprehensive have to be in there? To whose comprehension?

Facilitator – Is it safe to say that this is confusing? Yes!

Objectives and strategies – exploring financing options, etc. Do you understand? Some say yes, others no. I feel like there should be public input into where the system needs are.

Who are the stakeholders?

TxDOT needs to sit down and talk to cities, private businesses, people who are financing the roads and create more engines to finance projects.

Facilitator – Fund 6: do you know what that is? No clue.

The objective of communicating consequences will be measured by stating overall customer service. Sounds good but wants elaboration. What is understandable? To whom?

### **Goal: Cultivate Organizational Structure.**

What does this mean? Plan ahead. Build an organization. Last time I spoke to TxDOT about an issue on lighting, I talked to one guy who puts in lamps and he said no, I don't make the decisions. He went to another who pointed back at first person. This went on without resolution. Couldn't get any answers.

This is an internal goal.

Tina – How about revised goal wording? “Operate the department effectively and efficiently to address the travel needs of all Texans.” Most liked first slide. It sounds like this is the complaint department (internal). The first is more external.

Should use plain-person language. Examples needed for layperson.

Foster Transparency – info flows across TxDOT – get rid of transparent communication. Need to be clear and succinct. If they want to get to the point, keep it simple. The newspaper is written at the 4<sup>th</sup> grade level. This should be too.

Is there an issue with transparency? Transparency is opening up. It is obvious that TxDOT is not transparent since “transparent” is used so much.

Facilitator – Do you think it would be useful to break the internal and external goals down into two goals? Yes.

“Effective” should read “accountability” because if one guy messes up the other guy would also be held accountable. Can’t be effective without accountability. Another agrees.

Don’t forget about El Paso. We have congestion related to being on the border.

I’d like for this to go to the mayor and council to get input on this plan. This is not in laymen’s terms so we need their input.

TxDOT has to convince cities and counties to reduce urban sprawl. Push toward green development, high rises, etc. When asked if participant thinks this is responsibility of TxDOT he/she said, I think their mission should include convincing those who do land planning to stop allowing it.

## APPENDIX B: DEMOGRAPHICS OF FOCUS GROUPS

### Demographics

A diverse group of participants attended each of the three focus group meetings. As seen in [Table 17](#), there was a good representation of males and females, young and old, and education levels. Long term residents as well as newcomers were in attendance.

**Table 17. Demographics of Focus Groups.**

| Location  | Gender |        | Age   |       |       |       |       |       |       | Education |     |                       |                  |                     | Post Grad | Unk |                              |              |
|-----------|--------|--------|-------|-------|-------|-------|-------|-------|-------|-----------|-----|-----------------------|------------------|---------------------|-----------|-----|------------------------------|--------------|
|           | Male   | Female | 18-19 | 20-29 | 30-39 | 40-49 | 50-59 | 60-69 | 70-79 | 80+       | Unk | Less than High School | Some High School | High School Diploma |           |     | Vocational/ Technical School | Some College |
| Brownwood | 2      | 6      |       | 2     | 2     | 2     | 1     |       |       |           | 1   |                       |                  |                     | 2         | 1   |                              | 1            |
| El Paso   | 6      | 4      |       | 2     | 2     |       |       | 1     |       |           | 5   |                       |                  |                     | 2         | 2   |                              | 1            |
| Arlington | 5      | 4      |       |       | 1     | 1     | 2     |       |       |           | 5   |                       |                  |                     | 3         | 1   |                              | 5            |



## **APPENDIX C: DISCUSSION GUIDE**

### **FOCUS GROUP SCRIPT**

#### **TxDOT Strategic Goals Discussion**

##### **Part 1 – Sign Consent Forms (prior to beginning of focus group) – 5 minutes**

Participants will be asked to read and sign a consent form that has been approved by the Institutional Review Board at Texas A&M University. Participants will also be invited to enjoy beverages and snacks.

##### **Part 2 – Welcome and Introductions – 10 minutes**

Welcome to the focus group today. Special thanks to those of you who were able to join us again. We've taken what we heard from several focus groups over the summer, and TxDOT has used that information in drafting their strategic plan and the ways to measure whether the state is going in the right direction or not. The success of the group depends quite a bit on how willing you are to share with us what you think. So, I'm asking you right up front to be open and forthcoming and not to worry about what I might think, or what others in the group might think about what you say, or even if you are giving a viewpoint that disagrees with someone else's. We're not really talking today about matters that would be considered very sensitive, but the topic is one that we would expect people to have differing opinions on, so I do want to encourage lots of dialogue. Don't worry about the tape recorder. We will keep the tape to ourselves and just use it to help us with our notes. Try to forget that it's there. Let me assure you that we will always keep everything you say anonymous.

Having said that, I want you to relax and enjoy the conversation. But I do have to ask that you talk one-at-a-time, do not have any side conversations, and speak loudly so that everyone can hear what each person has to say. I don't expect our discussion to last more than about an hour and a half. If you need to get more refreshments or use the facilities, please feel free to get up at any time.

First I'd like us to have some brief introductions. I'll start with us...

Now, let's go around the room and say your first name only (because we're keeping this anonymous) and a little bit about who you are and how long have you lived in the area.

##### **Part 3 – Strategic Plan – 15 minutes**

OK, now we're ready to get on with the topic at hand. As I mentioned, we did an earlier focus group where we asked about priorities for transportation in Texas both in the short term and in the future. Now, we want to see what you think about TxDOT's strategic plan and get your thoughts on what constitutes success for TxDOT's goals. How many of you had a chance to review the strategic plan that I sent you?

What did you think? ? Was it clear? What three things does TxDOT think are important?

Next: Do you agree with the ideas?

Third: are there important elements that you don't see?

I want to show you a short presentation that relates the goals to the objectives necessary to achieve them and the strategies that might be used to achieve the goals. *Use parts of presentation to commission workshop.*

Basically – goals are what you want to become (what city you are going to on a road trip), you need some objectives to help you get there (towns along the trip) and performance measures tell you if you're going in the right direction and how fast.

Now let's talk more specifically about each of the goals.

#### **Part 4 – Goals – 40 minutes**

**Goal A: Maintain the existing Texas transportation system** (*Goals are lettered so as not to indicate priority order*)

*Show slide of goal with objectives and strategies*

In general, what does this goal mean to you?

Is it phrased correctly? Is there a better way to say it?

What aspects of this goal indicate success? An easy way to develop measure is to think about how to improve the situation and see if the measures show that improvement. (We need this here to get them to think about this topic before we get to measures.)

If TxDOT achieves this goal, how will your life be better?

Are these appropriate objectives to achieve the goal? Are there others that should be included?

Do the strategies support the objectives? Do the strategies mean anything to you?

*Show slide of strategies and performance measures*

Looking at the performance measures, do these mean anything to you?

Are they appropriate measurement indicators?

Are there others that would be more useful and meaningful to you?

*Repeat questions for each of the goals.*

**Goal B – Enhance safety for all Texas transportation system users**

**Goal C – Enhance system connectivity**

**Goal D – Promote congestion relief strategies**

**Goal E – Facilitate the development and exchange of comprehensive multimodal funding strategies with transportation program and project partners.** *Suggest re-wording to facilitate comprehensive funding strategies with transportation program and project partners.*

**Goal F – Cultivate an organizational structure and strategy designed to address the future multimodal transportation needs of all Texans.** *Suggest re-wording to “Operate the department effectively and efficiently to address the travel needs of all Texans.”*

**Part 5 – Review of goals – 10 minutes**



Looking back on the six goals, do some make more sense to you than others? Which ones are most understandable? What specific issues do you have with others? (*don't know what it means, not sure what it is trying to do, etc.*)

Should the goals be prioritized? *Have handout of goals and ask participants to rank.*

**Part 6 – Final Remarks – 5 minutes**

Again, I want to thank you for your time and participation. I want to give everyone a chance to say any final comments.

**Part 7 – Have participants sign payment sheet and distribute \$ 50.00/person.**



# **Draft TxDOT Strategic Plan 2011-2015**

*Mission, Vision, and Values Statements  
Goals, Objectives, Strategies, and  
Example Performance Measures*

Strategic Policy & Performance Management Office  
Texas Department of Transportation

December 18, 2009

## **Mission Statement**

Emphasizing cooperation, accountability and transparency, we will provide a safe, efficient, cost-effective, and environmentally sensitive statewide transportation system for the movement of people and goods.

## **Vision Statement**

To be a trusted, performance-driven organization committed to collaborating with internal and external partners to deliver a modern, interconnected, and multimodal transportation system that enhances the quality of life for Texas citizens and increases the competitive position for Texas industry.

## **Value Statements**

TxDOT will:

- Honor our commitments to the citizens of Texas with accountability and transparency;
- Provide the best value for every dollar spent;
- Earn and maintain the respect and trust of Texas citizens by listening, seeking to understand, and being responsive to our customers and stakeholders;
- Promote innovation, creativity, and collaboration;
- Promote, both with our employees and partners, high ethical conduct and a commitment to compliance with the law;
- Communicate openly and honestly;
- Protect the safety of the traveling public, our employees, and the workers who build, operate, and maintain our transportation system;
- Value diversity through inclusion, opportunity, and respect; and
- Support employee professional development.

*TxDOT 2011-2015 Draft Strategic Plan*

*Mission, Vision, and Value Statements*

*Draft Goals, Objectives, Example Performance Measures, and Strategies*

12/18/09

**Goal 1 - Cultivate an organizational structure and strategy designed to address the future multimodal transportation needs of all Texans.**

***Objective 1 – Develop a proactive internal and external communication plan that fosters transparency.***

**Example Performance Measure** – Overall customer satisfaction with timely, accurate, and understandable information

- **Strategy 1** – Establish guidance for ensuring proactive and transparent communication with the Legislature and citizens on agency program responsibilities, multimodal project selection, and resource allocation decisions at all levels of the organization.
- **Strategy 2** – Ensure flow of information to, from, and among all TxDOT offices at all levels.

**Objective 2 – Develop a comprehensive performance management program to enhance decision making, resource utilization, and product delivery.**

**Example Performance Measure** – On-time project design

- **Strategy 1** – Develop performance measures and reporting process for key goals and objectives.
- **Strategy 2** – Create a performance driven and transparent project prioritization and selection process.
- **Strategy 3** – Develop and implement a project delivery process that encourages participation by the full range of transportation, environmental, and community stakeholders (public and private) throughout the planning, design, and implementation process, from project concept to project delivery.

*TxDOT 2011-2015 Draft Strategic Plan*

*Mission, Vision, and Value Statements*

*Draft Goals, Objectives, Example Performance Measures, and Strategies*

12/18/09

**Objective 3 – Develop and nurture partnerships with communities, agencies, and other transportation stakeholders.**

**Example Performance Measure** – Overall partner satisfaction with their involvement in decision making

- **Strategy 1** – Collaborate with local and regional communities and stakeholders to plan, design, build, and maintain the state’s transportation infrastructure.

**Objective 4 – Enhance workforce recruitment, retention, and leadership development efforts.**

**Example Performance Measure** – Employee retention rate

- **Strategy 1** – Provide mentoring, formal and informal training, competitive compensation, and opportunities for professional growth to ensure that TxDOT attracts and maintains a highly skilled workforce.
- **Strategy 2** – Actively seek and value the input of employees in shaping the direction of the agency.

- **Strategy 3** – Review and update policies and procedures to ensure corporate knowledge transfer.
- **Strategy 4** – Promote workforce diversity.

*TxDOT 2011-2015 Draft Strategic Plan  
Mission, Vision, and Value Statements  
Draft Goals, Objectives, Example Performance Measures, and Strategies  
12/18/09 5*

**Goal 2 - Facilitate the development and exchange of comprehensive multimodal funding strategies with transportation program and project partners.**

***Objective 1 – Explore all available multimodal financing options while not recommending any particular strategy.***

**Example Performance Measure** – # of financing options developed with stakeholders

- **Strategy 1** – Work with stakeholders to develop likely alternative funding scenarios and describe potential mobility, safety, system condition, economic development, and environmental impacts.

***Objective 2 – Assess and document transportation system needs and available revenues in periodic updates of the long-range Texas Transportation Plan.***

**Example Performance Measure** – Percent variance between total Fund 6 revenue forecast and actual receipts

- **Strategy 1** – Provide regular updates of needs and revenue estimates and forecasts and communicate with internal and external stakeholders.

***Objective 3 – Regularly communicate with the Texas public the program results from maximizing existing funding levels as well as the consequences of alternative future funding levels.***

**Example Performance Measure** – Overall customer satisfaction with timely, accurate, and understandable information

- **Strategy 1** – Summarize and communicate information about the full set of potential funding and financing options available to Texas and best practices from other states.

*TxDOT 2011-2015 Draft Strategic Plan  
Mission, Vision, and Value Statements  
Draft Goals, Objectives, Example Performance Measures, and Strategies  
12/18/09 6*

**Goal 3 - Maintain the existing Texas transportation system.**

***Objective 1 – Develop optimal asset management programs to protect existing infrastructure investments.***

**Example Performance Measure** – Percent of lane-miles on the state highway system that have a pavement condition rating of “good” or better

- **Strategy 1** – Identify, define, and implement best practices for routine maintenance to extend the useful life of system elements.
- **Strategy 2** – Identify, define, and implement best practices for preventative maintenance to avoid and minimize the risk of future extensive rehabilitation.
- **Strategy 3** – Identify, define, and implement best practices for substandard infrastructure rehabilitation to maintain the safe and efficient use of the system.
- **Strategy 4** – Establish and implement environmental stewardship standards, based on best practices, within maintenance programs.

**Objective 2 – Ensure timely and effective emergency maintenance response and damage repair.**

**Example Performance Measure** – Average duration of road closures following emergency incidents

- **Strategy 1** – Standardize emergency maintenance response strategies, including lines of communication, response protocols, and staff responsibilities.
- **Strategy 2** – Timely communicate with the public the nature and location of damaged infrastructure and the estimated time for repair.
- **Strategy 3** – Identify and implement best practices to react more timely to damage from unforeseen events.

*TxDOT 2011-2015 Draft Strategic Plan*

*Mission, Vision, and Value Statements*

*Draft Goals, Objectives, Example Performance Measures, and Strategies*

12/18/09

**Objective 3 – Measure, monitor, and report performance in maintaining the existing transportation system.**

**Example Performance Measure** – Quarterly publication of agency accountability report that identifies potential performance improvements

- **Strategy 1** – Develop quarterly performance reporting mechanism, publish results, and identify areas for improvement in system maintenance.

**Goal 4 - Promote congestion relief strategies.**

***Objective 1 – Implement multimodal infrastructure, operational, and technological solutions to congestion needs.***

**Example Performance Measure – Statewide Congestion Index**

- **Strategy 1** – Work with partners to develop regional congestion management plans.
- **Strategy 2** – Identify, fund, and manage operational, technology, and policy strategies to address congestion first prior to investing in new capacity.
- **Strategy 3** – Work with local and regional partners to improve incident management strategies to combat non-recurring congestion impacts.

***Objective 2 – Focus congestion relief efforts on the most severely congested elements of the state transportation system.***

**Example Performance Measure – Percentage of mobility funding allocated to the top 100 most congested highway segments compared to total mobility funding**

- **Strategy 1** – Develop and implement a process to prioritize congestion relief projects, taking into consideration regional differences as well as mobility, economic, environmental, and social costs, benefits, and impacts.
- **Strategy 2** – Fund and manage the construction and implementation of prioritized congestion relief projects and programs.

***Objective 3 – Measure, monitor, and report performance in providing congestion relief.***

**Example Performance Measure - Quarterly publication of agency accountability report that identifies potential performance improvements**

- **Strategy 1** – Develop quarterly performance reporting mechanism, publish results, and identify areas for improvement in congestion relief.

**Goal 5 - Enhance system connectivity.**

***Objective 1 – Ensure Texas industries can efficiently access statewide, regional, national, and international markets and gateways.***

**Example Performance Measure – # of projects and \$ received from the private sector to support business infrastructure access improvements**



- **Strategy 1** – Identify the existing and emerging industries, gateways, and facilities that contribute most to current and future economic vitality.
- **Strategy 2** – Develop a process to prioritize connectivity improvements for Texas industries and gateways.
- **Strategy 3** – Fund and manage the construction and implementation of prioritized connectivity projects and programs.

***Objective 2 – Provide seamless, multimodal transportation facilities and networks to connect all statewide population, economic, recreational, and cultural centers.***

**Example Performance Measure** – # of lane miles added to the state system near key recreational and cultural activity centers

- **Strategy 1** – Work with local and regional stakeholders to identify the population, economic, recreational, and cultural centers that contribute most to statewide and regional quality of life.
- **Strategy 2** – Develop a process to prioritize regional and statewide connectivity improvements, taking into consideration mobility, economic, environmental, and social costs, benefits, and impacts.
- **Strategy 3** – Fund and manage the construction and implementation of prioritized connectivity projects and programs.

*TxDOT 2011-2015 Draft Strategic Plan  
Mission, Vision, and Value Statements  
Draft Goals, Objectives, Example Performance Measures, and Strategies  
12/18/09*

***Objective 3 – Measure, monitor, and report performance in enhancing system connectivity.***

**Example Performance Measure** - Quarterly publication of agency accountability report that identifies potential performance improvements

- **Strategy 1** – Develop quarterly performance reporting mechanism, publish results, and identify areas for improvement in system connectivity.

*TxDOT 2011-2015 Draft Strategic Plan  
Mission, Vision, and Value Statements  
Draft Goals, Objectives, Example Performance Measures, and Strategies  
12/18/09*

**Goal 5 - Enhance safety for all Texas transportation system users.**

***Objective 1 – Reduce fatalities and serious injuries on the Texas transportation system.***

**Example Performance Measure** – Number of fatalities per 100,000,000 miles traveled on the Texas state highway system

- **Strategy 1** – Identify and implement system wide, corridor, and project-level best practices for improving safety and develop an approach to guide investment decisions in the Strategic Highway Safety Plan.
- **Strategy 2** – Influence driver behavior by supporting safety outreach programs proportionate to demonstrated safety problems.
- **Strategy 3** – Assess the roadway system to enhance the safety of multimodal interfaces, including interactions between vehicles, pedestrians, bicycles, rail, and other alternative modes.

***Objective 2 – Partner with public and private entities to plan for, coordinate, and respond to disasters and emergencies.***

**Example Performance Measure** – Evaluation rating of TxDOT disaster response strategies/readiness

- **Strategy 1** – Partner with public and private entities to establish lines of communication, develop emergency management and response plans for a diverse array of disasters and emergencies, and periodically evaluate the effectiveness of response strategies.
- **Strategy 2** – Provide public information on TxDOT’s emergency services, using a variety of traveler information platforms.
- **Strategy 3** – Conduct emergency preparedness exercises to practice response plan execution.

*TxDOT 2011-2015 Draft Strategic Plan*

*Mission, Vision, and Value Statements*

*Draft Goals, Objectives, Example Performance Measures, and Strategies*

12/18/09

***Objective 3 – Promote work zone safety to protect roadway workers and the traveling public.***

**Example Performance Measure** – Number of fatalities and serious injuries in work zones

- **Strategy 1** – Identify and implement best practices for work zone management, including standards for the number, duration, and impact of work zones.
- **Strategy 2** – Provide workforce training, improve contractor enforcement, and increase knowledge and safety awareness of work zones.
- **Strategy 3** – Improve work zone traffic control devices and design practices.
- **Strategy 4** – Improve driver compliance with work zone traffic controls through the use of law enforcement officers trained in enforcement procedures in work zones.

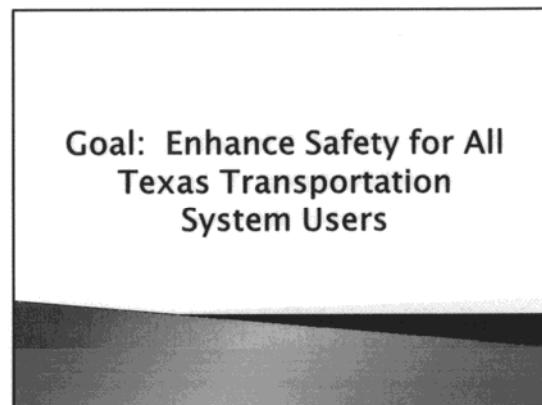
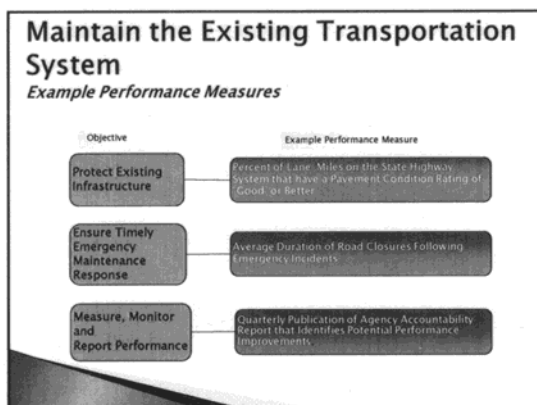
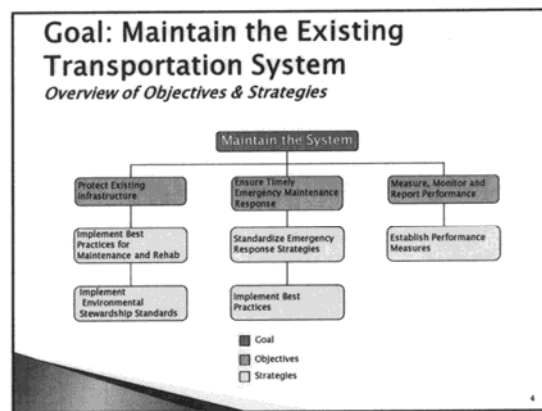
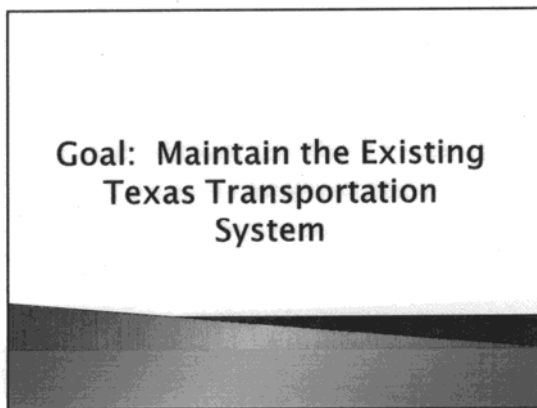
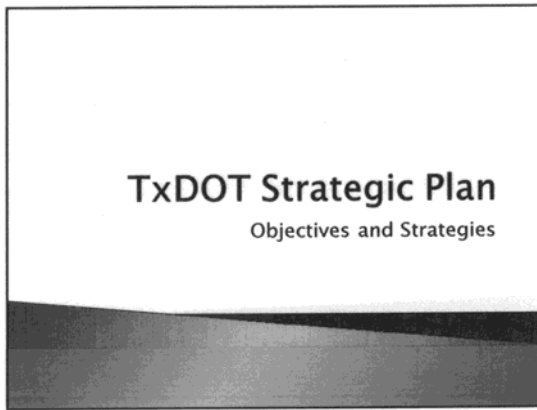
***Objective 4 – Measure, monitor, and report performance in improving safety.***

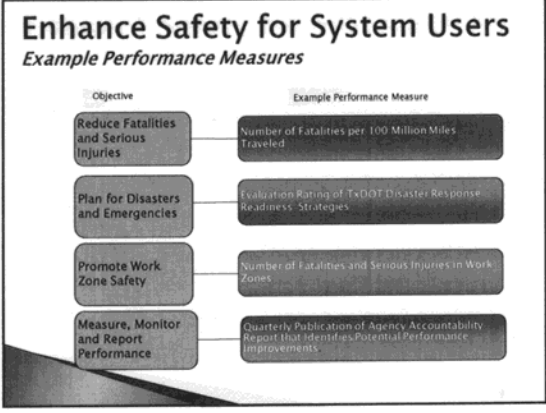
**Example Performance Measure** – Quarterly publication of agency accountability report that identifies potential performance improvements

- **Strategy 1** – Develop quarterly performance reporting mechanism, publish results, and identify areas for safety improvements.

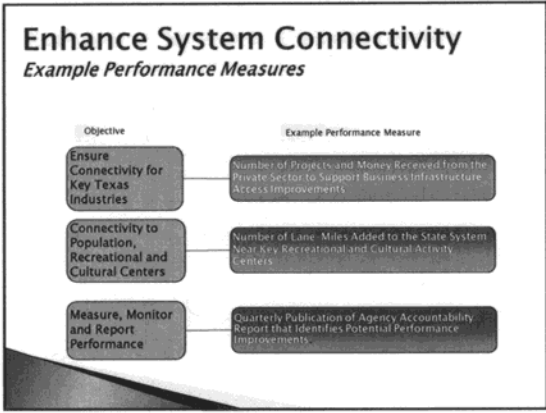
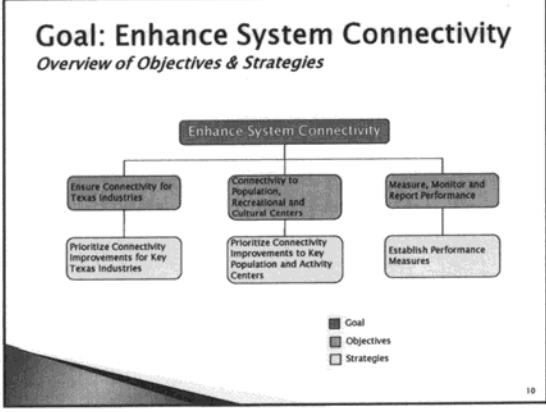


**APPENDIX E: SLIDES PRESENTED TO FOCUS GROUPS**

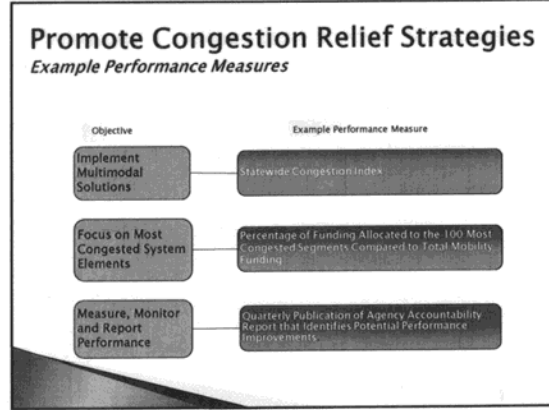




## Goal: Enhance System Connectivity

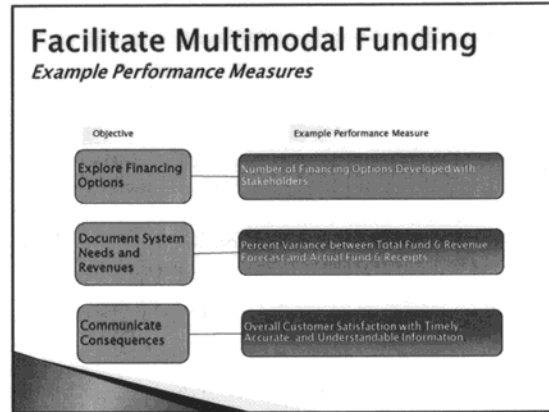


## Goal: Promote Congestion Relief Strategies



### Goal: Facilitate the Development and Exchange of Comprehensive Multimodal Funding Strategies with Transportation Program and Project Partners

### Goal: Facilitate Comprehensive Funding Strategies with Transportation Program and Project Partners



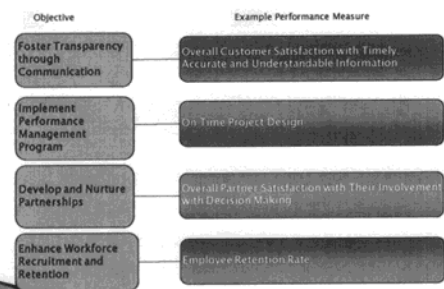
**Goal: Cultivate an Organizational Structure and Strategy Designed to Address the Future Multimodal Transportation Needs of All Texans**

**Goal: Operate the Department Effectively and Efficiently to Address the Travel Needs of All Texans**

**Goal: Effective Agency Organization**  
*Overview of Objectives & Strategies*



**Organizational Effectiveness**  
*Example Performance Measures*





## **WORK REQUEST EIGHT: DEVELOPING A CONGESTION PERFORMANCE MEASURE SUBCOMMITTEE CONCEPT PAPER**

Building on several research reports, position papers, and conference proceedings, the following principles and possible approaches are offered for discussion related to a Congestion Performance Measure by the American Association of State Highway and Transportation Officials (AASHTO) Standing Committee on Performance Measurement.

### **SUMMARY**

The key elements of the Congestion Performance Measure are outlined below. These are related to the desired outcomes and to other performance measure topics. Key elements for AASHTO discussion include:

- Approach – Each community should develop the measures that best reflect their vision. National measures, if used, should apply to the national system, focus on issues of national importance (e.g., freight), and recognize that improvements must also work in, and be consistent with, the desires of the local community.
- Trends and Targets – Developing consistent data sets and understanding the patterns, causes, and congestion trends at the corridor, regional, state, and national level will be more important than setting targets. However it is anticipated that some level of target setting is desired in the coming reauthorization.
  - Based on insights gained from other countries (during a recent AASHTO scan) that have used national targets over many years, AASHTO suggests that the federal government set specific, national policy goals. These goals would then be applied by states and regions to set desired target values.
  - State and or Regional Targets – A *set* of realistic performance targets should be determined locally (state and region) once trend data and explanatory variables have been collected and available for multiple years. The regional average congestion value may be the primary metric used in public functions.
  - National target – The role for a national congestion value may be limited to routes that serve an important national interest. Important freight travel routes, border crossings, key freight connections, and urban corridors during off-peak hours are examples. Evacuation routes, national defense mobilization corridors, and other network elements may also qualify. As with the state and local measures, the availability of reliable trend data and explanatory information is necessary before national target values can be set.
- Measures – A set of a few performance measures appears appropriate at the regional and state summary level. Ultimately, this should include at least one “average congestion” measure, one “total congestion” measure, and one “travel time reliability” measure. A single average congestion measure may be used to discuss problems and to serve as an indicator. It is important to note that focused action and specific strategies require several measures that are tracked at the corridor level; the

effect of most actions will be illustrated at the corridor level but may not be seen at the regional level.

- *Total travel delay* is a measure of the total amount of extra time suffered by all travelers in the designated geography. This is very useful for economic and “total congestion effect” reporting.
- *Peak period travel delay per commuter* is a good regional average measure; it is easily understood and may be directly affected by all solutions. (Whether the term is “commuter” or “peak period traveler” the measure illustrates the extra travel time for the morning and evening peak travel periods.)
- *Congestion Cost* is the value of wasted fuel and travel delay and is an important measure for discussions with the public and a component of improvement analyses.
- *Buffer Index* is an easily understood and useful measure of the variation in travel time; it is affected by a range of operations improvements. This measure requires much more travel speed data than the other three, and should not initially be included as a national measure until further data experimentation is conducted.
- Data – It will be necessary to purchase a national set of travel time (or speed) data from a private sector data provider. The data would allow states and urban areas to produce all of the congestion performance measures. The travel time data should be used to develop the set of performance measures, establish multi-year trends, and conduct a congestion analysis before any local or national target values are chosen. Some states and regions also have travel time data from intelligent transportation systems (ITS) instruments. The national data set could be used in combination with the ITS data, as a supplement for missing corridor data and to assist in quality control analyses.
- System Productivity and Efficiency Measures – In addition to travel time data, states and regions should continue to collect volume data that will not be available from private vendors. Volume data are necessary to measure the productivity of the system and to analyze past and future investments.
- Peak and off-peak measures are needed – Commuter conditions are important, but freight also moves in the midday and overnight periods. It may be more important to maintain a reliable, smooth flowing transportation network when and where freight movement occurs.
- Average and reliability measures – Regular congestion problems are typically included in performance reporting, but the variation in travel time is caused by different issues and have a different set of solutions than the typical “too many cars on too little road” type of problem.
- Accountability and Transparency – Will be provided in several ways. The measures and possible target values will be developed by the communities (not imposed from the outside). Each area should be responsible for identifying and understanding their data trends and, if no progress, the reason why. The development of an open process

and visible and measurable measures and trends will provide a connection between annual project lists and ultimate goals of the chosen set of projects.

- Project priorities – Should be chosen - *at least in part* - according to their role in alleviating the problems identified in the performance measures. The measures should illustrate the effect of all types of strategies being used to address congestion problems – added capacity, operational improvements, demand management, and land use development patterns.

## **THE CONCEPT AND FRAMEWORK**

### **What Are We Trying to Measure?**

*If It Is Being Offered as a Solution, It Should Show up in the Measure.*

The measures should identify the congestion problems and the effect of all possible solutions. These solutions include both transportation and land use approaches. The effect of the entire range of possible solutions should be shown including, for example, adding lanes, bus routes and rail lines, improved traffic signal operations, rapid removal of crashed or stalled vehicles, access management treatments, flexible work hours, commute travel options, telecommuting, bicycle travel, pedestrian treatments, and land use development patterns that reduce vehicle travel.

### **What Are We Trying to Compare?**

*Trends and Targets*

As described in the AASHTO position paper, the measure will be used to identify and understand a region's trend and compare current and projected levels against possible targets for that region. Some of the measures should also be appropriate for use at corridor and sub-regional levels.

### **Why Are We Trying to Compare?**

*If You Do Not Measure It, You Will Not Do It*

The value of the congestion measure is to ensure that investment decisions appropriately target congestion problems. Changes in the amount of investment and the project and program decisions may be needed to better address critical congestion problems. Performance measures, therefore, should be calculated at the region level and at the corridor or project level.

### **Who Should Set the Congestion Goal?**

*There Is a Role for Locally Developed Goals **and** National Goals to Ensure Economic Competitiveness and National Security*

Each state and metropolitan region is in the best position to decide its congestion goal given the community desires, the long-range growth plans, economic status, and other competing funding priorities.

- **DISCUSSION POINT** – National congestion level >> The federal government has a legitimate and compelling interest in maintaining the service quality on the National Highway System. Congestion that hinders national and international travel and trade is not in the national interest. A national congestion policy goal that focuses on the time periods of the day when commuting travel is not a substantial portion of trips (for example, outside of 6 to 9 a.m. and 4 to 7 p.m.) may be appropriate. Such a policy goal recognizes the importance of freight movement and manufacturing industries that are not solely focused on peak periods.

## **Are We Trying to Develop a “Top 10 List” of Most Congested Regions?**

*We Seek Consistent “Measuring Spoons” not “Cookie-Cutter” Policy Decisions*

No, we are not focused on developing a top 10 list. The value of a national top 10 list pales in comparison to a congestion goal that is supported by the community. Since each region prioritizes congestion relief differently, and will choose to attack each congestion problem differently, the value is in developing a congestion strategy and a measurement approach, rather than crafting a national standard congestion target. A “one size of congestion fits all” state or regional goal will invariably be an easier accomplishment for small regions or those that are not seeing population and employment growth, and an impossible goal for the regions that are creating jobs at a rapid rate. Top 10 lists are good for publicity about transportation solutions and benefits, but they are not good decision-making tools.

## **Who Is the Audience?**

*If You Are Not Sure Who You Are Talking to, How Can You Know You Are Using the Right Language?*

There are many audiences, but in general there are two groups. There are many public, decision-makers, policy experts, and stakeholders that form an external and diverse audience of information consumers. There are also many internal consumers of congestion information within an agency including leaders, planners, designers, and operators.

## **What if There Is No Progress toward the Region’s Self-Defined Congestion Trend or Goal?**

*Use Carrots, Not Sticks. Encourage Agencies to Invest in Projects that Are Consistent with the Goals They Set*

There are a number of reasons a region may not be making progress. These reasons include combinations of poor priority setting, much more growth than anticipated, or underfunding of transportation. In these situations, agencies should undertake an analysis of:

1. agency spending in a few broad categories to determine if one topic area is receiving “more than its share” of the funding,
2. the mobility-related funding to determine if the set of projects that are being selected are not moving the region toward their goals, and
3. the types of projects to ensure that proper investigation of all project and program options (large and small) have been considered.

## **How Should the Differences in Urban and Rural Congestion Be Handled?**

*Each Region Should Decide How Much Congestion They Wish to Tolerate*

This is a state and local policy decision. Different targets are appropriate for urban and rural areas. There are different expectations for congestion in every region. Comparisons to irrelevant conditions (i.e., comparing rural and big city traffic problems) are not helpful and do not provide citizens with a sense their funds are being spent wisely. Most states and many large MPOs have some sort of “fair share” arrangement for returning funding to areas in relation to the taxes paid from that area. In most cases, therefore, rural added capacity projects do not compete for funding with metro region projects.

## **MEASUREMENT SPECS**

### **Some of the Congestion Measures Should Work at Several Different Levels of Geography**

*Providing Measures that Are “Useful” for a Variety of Purposes Will Accelerate Their Implementation*

Providing a congestion measure that is meaningful at the project and corridor level will improve the chances that the measure will be adopted as a part of regular decision-making practice. It is not necessary that all of the measures satisfy the criteria. The relevant geographies include project, corridor, sub-region, and region.

### **The Measures Should Provide Mode-Neutral Comparisons**

*A Broad and Level “Playing Field” Is Needed so All Modes Can Be Compared*

Travel time and person volume related quantities allow for cross-modal and multi-modal comparisons.

### **The Measures Should Include Attributes that Are Important to Freight Shippers**

*The Movement of Goods Is Critical to a Healthy Economy and Should Be Reflected in the Measures*

Travel time and travel time reliability are important elements in freight mode and route decisions. A measure of the cost of travel delay that recognizes the higher value of an hour of freight delay than an hour of commuter delay enhances the usefulness of the measures and connects to the concerns of shippers, manufacturers, and travelers alike.

### **The Measures Should Monitor Congestion Trends over Time from the Full Range of Congestion Causes**

*If You Do Not Know the Real Problems, You Cannot Develop Solutions*

There are many congestion causes (e.g., unusual demand, incidents, work zones, special events, operating system failures, weather, and inadequate capacity). Some of these are more difficult to monitor or estimate than others, but the cause of the problem(s) must be diagnosed

before a solution can be identified. The proposed national measures are a good start and serve as general indicators. They should be supplemented with a range of other state and regional analyses and performance measures that allow for a more thorough analysis at the corridor and network level.

## **DESCRIBING THE MEASURES**

The effect of the broad principles is that a range of measures will be needed to address the key questions. Regions may choose to highlight different measures, but a robust performance measure system should have all of the following attributes.

### **The Congestion Measure Should Be Separate from the Congestion Target**

*Do Not Confuse People with the Measure when You Want Them to Focus on **What to Do** with the Measure. Use a Simple Measure, a Simple Target, and Explain Both.*

Bundling the measure and target into one metric (e.g., creating an index comparing the growth in congestion to the growth in jobs) will be difficult to explain. Two simple metrics will be easier to use and explain—a congestion measure that can be easily explained and a target that includes a component of population, job or economic growth.

- The alternative is bundling the measure and the target in a way that normalizes all the determining factors. As an example, one could produce a measure of congestion that would change according to job growth; the target might be “keep the measure value the same from year to year.” In this case, congestion is really growing every year, but it would be growing at the same rate as the job market. (Historically, delay per peak period traveler has grown at about triple the rate of population growth.) This approach is hard to describe, unnecessarily complicates the message, and risks appearing as though “games are being played.”

### **A Set of Congestion Measures Should Be Used**

*Many Problems, Many Solutions, Many Measures*

Several measures will be needed to describe problems and the effect of solutions on the system as a whole and on specific modes or elements as needed for evaluation. The recommended national set includes:

- Travel delay – A measure of the total amount of extra time suffered by all travelers in the designated geography. This is very useful for economic and “total congestion effect” reporting.
- Travel delay per commuter – A measure of regional traffic congestion for individuals.
- Congestion Cost – The value of fuel and travel delay is an important measure for discussions with the public and a component of improvement analyses.

Other measures that provide additional information on the effect of programs or which are applicable at other geographic levels or time periods:

- Travel Time Index – A measure of the extra time that travelers must allow for an average peak period trip. A value of 1.50 says that a 20 minute off-peak trip takes 30 minutes in the peak period. This measure is applicable to the broadest range of uses, but is not sufficient by itself.
- Total travel time – A measure that brings in the effect of transportation improvements and denser land use patterns that may combine to create trips that take less time. This measure (in person-hours) would include vehicle, walk, bike, and transit modes in one value.
- Buffer Index – A measure of travel time reliability; the percentage of extra time that should be allowed to make an important trip and arrive on time. The Buffer Index (BI) is a ratio of the travel time to accomplish the 19<sup>th</sup> worst trip out of 20 compared to the average travel time (i.e., the 95<sup>th</sup> percentile travel time). The Buffer Index is explained as ‘one should allow an extra BI percent of time for important trips.’ Other percentiles should also be studied to determine which are the most illustrative for each analytical purpose.
- Economic benefits – The benefits to travelers and the economy represent the reason why solutions are pursued. There are several approaches to creating these estimates; it is important that one approach is chosen and used. If the discussion only includes costs and does not include benefits, it will be difficult to convince the public or decision makers to invest more.

Relating the measures to important aspects for person and freight travel:

- *Extra travel time* is a drain on the economy and leads to increased frustration. Most of the measures have an “extra time” component.
- The *unreliability of travel time* has a particularly onerous effect on freight travel and just-in-time manufacturers. Late deliveries or an inefficient process caused by a poorly functioning transportation system affects competitiveness.
- *Economic measures* are particularly relevant to the general public and the business community. If parents only knew how much college cost, there would be very few students; there is a lot of discussion about the value of education.

### **The Geography Used by Each Region Does Not Have to be the Same**

Long-range planning models are a good source for the data because they include the effect of transportation and land-use actions. There is, however, no consistency in the area included in the travel demand models used by metropolitan planners across the country. Urbanized area data may also be useful because the area includes only the developed portion of each region, a more consistent and similar comparison than the metropolitan area boundary.

### **The Geography Should be the Same from Year to Year**

Using the same geographic area will illustrate the effect of the solutions (rather than the effect of boundary changes). If a sliding boundary is used, the capacity additions will appear much larger than they are (because existing roads will be re-designated when the boundary is moved).

## The Target Does Not Have to be the Same in Every Region, in Every Region of the Same Size, or Even in All Parts of a Region

Downtowns may be able to accommodate more road congestion due to the presence of a variety of modal alternatives including transit, bike, and walk, and because destinations (jobs, shops, etc.) are nearby. Suburban areas and rural travelers have different alternative travel options and different congestion expectations. Each community is best positioned to balance the wide variety of interests and expectations.

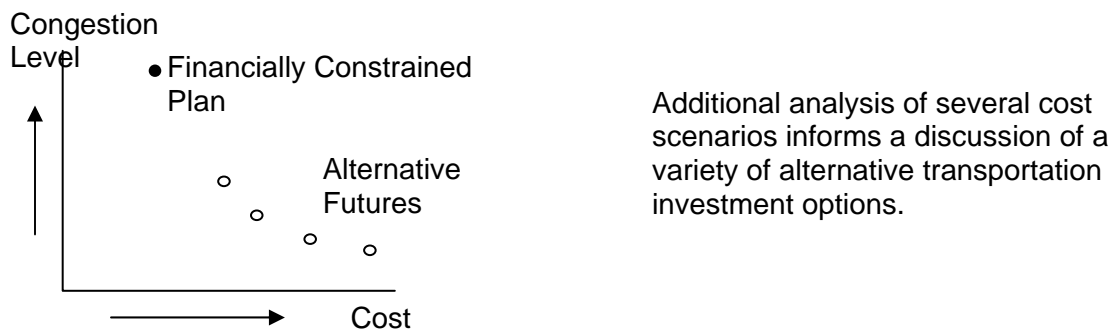
### OTHER MEASUREMENT ISSUES

The practical effect of any move toward using performance measures will be that more before-after studies of the effect of projects, programs, and policies should be conducted. All projects are evaluated in some level of detail before implementation, but very few are examined afterwards. Many are not even studied in an effort to maximize the return from the investment. In addition, it is difficult to discuss the need for additional funding or more flexibility if there are no evaluations of prior spending programs.

Studies of the effect of additional investments beyond the expected revenue (the financially constrained metropolitan transportation plan) should be developed to identify the funding needs for a range of optional congestion targets, and to identify the benefits from such investments. Scenarios might include:

- Reduce congestion.
- Prevent worsening congestion.
- Maintain economic competitiveness of the State.
- Congestion growth matches population growth.

Figure 9 depicts one outcome of these studies; additional information on the costs and benefits of additional investment in transportation and/or the effect of alternative land use development strategies. These can be created as an extension of current planning activities that focus on producing only a financially constrained plan. Showing the reduction in congestion that comes from additional investment is one component of a program of performance management.



**Figure 9. Displaying the Effect of Additional Investment on Congestion Levels: an Example of Performance Measurement Analysis Results.**



## **WORK REQUEST NINE: ANALYSIS PROCEDURES AND MOBILITY PERFORMANCE MEASURES 100 MOST CONGESTED TEXAS ROAD SECTIONS**

This memo documents the analysis conducted for the revised “100 Most Congested Road Sections” list. This revision incorporates private sector traffic speed data from calendar year 2009 into the calculation of the mobility performance measures presented in the initial calculations. A longer memorandum is available; it provides more detail on the calculation procedures and the performance measures used in 2010 to improve the information provided about the location and timing of congestion.

### **THE DATA IMPROVEMENTS - OVERVIEW**

TxDOT’s 100 Most Congested Road Sections website (<http://apps.dot.state.tx.us/apps/rider56/list.htm>) illustrates the severity and extent of Texas’ traffic congestion problem. The analysis is conducted on all roads in Texas regardless of the agency that built or maintains them. The first methodology used a set of estimation procedures and data provided by TxDOT and regional planning agencies to develop a set of mobility measures. This memo describes the 2010 calculation procedure that uses a dataset of traffic speeds from INRIX, a private company that provides travel time information to a variety of customers. INRIX’s data are an annual average of traffic speed for each road segment on each day for every 15 minutes - 672 day/time period cells (24 hours x 7 days x 4 times per hour).

INRIX’s speed data improve the freeway and arterial street congestion measures in the following ways:

- “Real” rush hour speeds were used to estimate a range of congestion measures; speeds are measured not estimated.
- Overnight speeds were used to identify the free-flow speeds that are used as a comparison standard; low-volume speeds on each road section will be used as the comparison standard.
- The volume and roadway inventory data from TxDOT’s files were used with the speeds to calculate travel delay statistics; the best speed data are combined with the best volume information to produce high-quality congestion measures.

### **The Congestion Measure Calculation**

The following steps were used to calculate the congestion performance measures and identify the 100 most congested road sections.

1. Obtain TxDOT Roadway-Highway Inventory (RHiNo) traffic volume data by road section.
2. Match the RHiNo road network sections with the traffic speed dataset road sections.
3. Estimate traffic volumes for each 15-minute time interval from the daily volume data.
4. Calculate average travel speed and total delay for each 15-minute interval.

5. Establish free-flow (i.e., low volume) travel speed.
6. Calculate congestion performance measures.
7. Combine road segments into sections.

The mobility measures require four data inputs: (1) actual travel speed, (2) free-flow travel speed, (3) vehicle volume, and (4) vehicle occupancy (persons per vehicle). The 2009 private sector traffic speed data provided a better source for the first two inputs, actual and free-flow travel time. The top 100 congestion analysis required vehicle and person volume estimates for the delay calculations; these were obtained from TxDOT's RHiNo dataset and travel planning studies.

## **Process Description**

The following sections describe the seven calculation steps and the performance measures that were generated for the determination of the 100 most congested road sections. Some short road sections were included in this method (using 2009 speed data for the August 2010 list) but, in general, shorter sections (less than 2 miles) are still not included. Sections of road or times of day without INRIX traffic speed data were estimated using either near time data (the adjacent 15-minute periods) or similar sections of road from similar population size regions based on functional class and volume per lane. There were no sections of road in the top 100 that required significant speed estimation.

### *Step 1. Identify Traffic Volume Data*

The Roadway-Highway Inventory dataset from TxDOT provided the source for traffic volume data, although the geographic designations in the RHiNo dataset are not identical to the private sector speed data. Volume estimates for each day of the week (to match the speed database) were created from the annual average volume data.

### *Step 2. Combine the Road Networks for Traffic Volume and Speed Data*

The road networks for the traffic volume and speed data sources were combined so that an estimate of traffic speed and traffic volume was available for each roadway segment. The segmentation of each roadway was based on the criteria used in the initial top 100 most congested list (for example, sections between 3 and 10 miles long with similar volume and road design features).

### *Step 3. Estimate Traffic Volumes for Shorter Time Intervals*

The third step was to estimate traffic volumes for the 15-minute time intervals. The lowest traffic speeds (morning or evening) were used to assign a traffic volume profiles (volume percentage for each 15-minute period) to each road segment. Congested roads tend to have more than one "peak" hour and many have high volumes in the middle of the day.

#### *Step 4. Calculate Travel Speed and Time*

The 15-minute speed and volume data were combined to calculate the total travel time for each 15-minute time period. The 15-minute volume for each segment was multiplied by the corresponding travel time to get a quantity of vehicle-hours.

#### *Step 5. Establish Free-Flow Travel Speed and Time*

The calculation of congestion measures required establishing a congestion threshold, such that delay was accumulated for any time period once the speeds are lower than the congestion threshold. For the purpose of the 100 most congested list, the data were used to identify the speed at low volume conditions (for example, 10 p.m. to 5 a.m.). The speed limit was used as an upper value and freeway free-flow speeds were capped at 65 mph.

#### *Step 6. Calculate Congestion Performance Measures*

The mobility performance measures were calculated using the data generated in Steps 1 to 5.

- Texas Congestion Index – The TCI is a unitless measure that indicates the amount of extra time for any trip. A TCI value of 1.40 indicates a 20-minute trip in the off-peak will take 28 minutes in the peak.
- Rider 56 specified the TCI as the performance measure for congestion.
- Total delay – The best measure of the size of the congestion problem is the annual travel delay (in person-hours). This measure combines elements of the TCI (intensity of congestion on any section of road) with a magnitude element (the amount of people suffering that congestion).
- Total delay per mile of road – One combination of a delay measure and the “indexed” approach is to divide total section delay (in person-hours) by the road length. So the measure of “hours of delay per mile of road” indicates the level of congestion problem without the different section lengths affecting the ranking. This is the performance measure that best identifies most congested segments.
- Congestion Cost – Two cost components are associated with congestion: delay cost and fuel cost. The cost of delay and fuel in the 2010 most congested list is \$21.75 per hour of delay.
- Commuter Stress Index – The CSI measure is calculated as the average of the TCI values from the most congested direction of each peak period (for example, inbound from suburbs in the morning and outbound to the suburbs in the evening).
- Time of Congestion – The times of day when each road direction speed is below 75 percent of the street free-flow speed or 80 percent of the freeway free-flow speed is shown for each of the 100 most congested sections (for example, below 48 mph on a 60 mph freeway).

### *Step 7. Calculate Congestion Performance Measures For Each Road Section*

Steps 1 through 6 were performed using the short road segments for analysis. The 100 most congested sections list was intended to identify longer sections of congested road, rather than short bottlenecks. The segment values from two measures—total delay and congestion cost—can be added together to create a section value. The remaining measures require some sort of averaging process; a weighted average of traveler experience was used in these cases. Time periods or road segments with more volume should “count for more” than time periods/segments with less volume. The following steps were used:

- Delay per mile – The delay from the section was divided by the length of the section.
- Time of congestion – The highest value of any segment was used as the value for the section.
- Texas Congestion Index and Commuter Stress Index – The values from the six peak hours (6 to 9 a.m. and 4 to 7 p.m.) for travel time, speed, and delay were summed and divided by the total volume to obtain a weighted average travel time, speed, and delay for each peak period. A similar approach was used to calculate the combined morning and evening peak period index values.

### **CHANGE FROM THE 2009 MOST CONGESTED LIST**

Figure 10 illustrates the differences between the 2009 and 2010 methodology. In Figure 10 (Exhibit 1), the real speed profile does not decline to the levels estimated with the 2009 process and speeds do not remain low for as long as predicted. Delay in the “other peak period” (evening) is also not as serious as estimated in 2009. Midday delay, however, partially compensates for the “missing” peak delay.

Figure 10 (Exhibit 2) illustrates a freeway segment at a bottleneck location; a point where the roadway design or traffic volume causes a serious constriction and low speeds. The 2009 method typically underestimates delay at these locations. While the off-peak period delay using the new method is less than would have been estimated, there is more midday delay and the evening peak period congestion begins sooner, lasts longer, and results in much worse travel times than the 2009 method would show.

There are more sections like Figure 10 (Exhibit 1) than Figure 10 (Exhibit 2) in the 2010 list, but the delay differences between the two methods are less than 10 percent for most sections of freeways and streets.

Exhibit 1. Speed Comparison (Old versus New) for Typical High Congestion Freeway Section

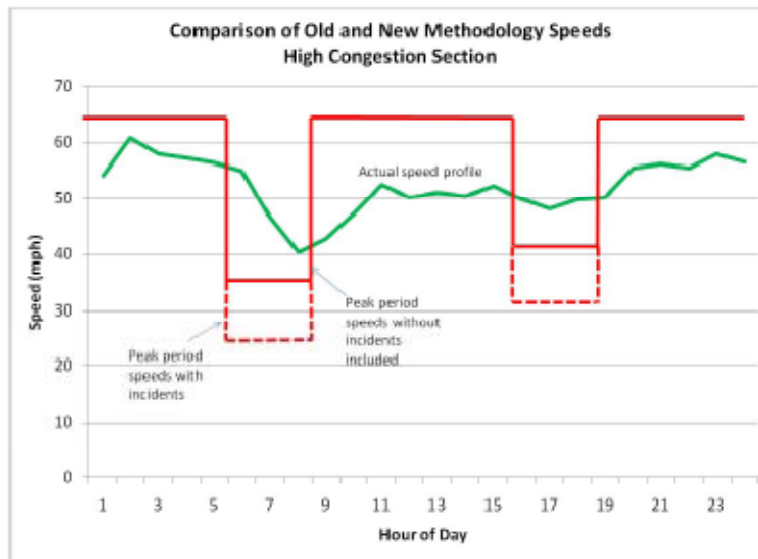


Exhibit 2. Speed Comparison (Old versus New) for a "Bottleneck" Freeway Section

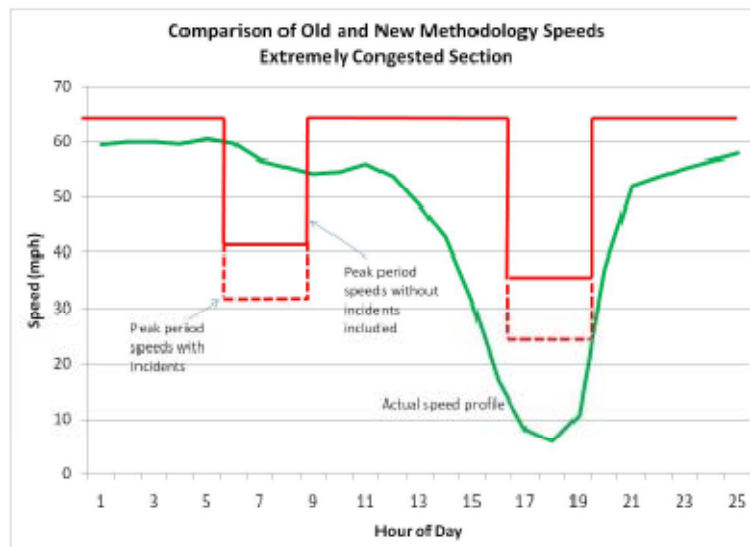


Figure 10. (1) Speed Comparison (Old versus New) for Typical High Congestion Free Section; (2) Speed Comparison (Old versus New) for a Bottleneck Freeway Section.



# **WORK REQUEST TEN: CONGESTION ESTIMATION FOR TEXAS ROAD IMPROVEMENTS METHODOLOGY DESCRIPTION FOR PROPOSITIONS 12 AND 14, AND RIDER 55**

**(Note, see [work request nine](#) for later work based on real speeds.)**  
by Tim Lomax and David Schrank

Several recent analyses have required an estimate of the congestion benefits from a variety of project improvements. This technical memorandum describes the process used to conduct those analyses with the best available comprehensive data sources. These analysis procedures have been used to analyze the candidate projects for Proposition 12 and 14 funding and the project list to meet the requirements of Rider 55.

The procedures include enhancements from the steps used in developing the list of the 100 most congested roadway sections in the state (Rider 56). The same performance measures are calculated, but there are additional roadway classes and project types in the Propositions 12 and 14, and Rider 55 programs; these required additional analytical steps. These additions are consistent with the Rider 56 requirements, and will be incorporated into updated lists of the 100 most congested sections.

## **ANALYSIS STEPS**

### **Step 1. Create Road Sections and Compile Database for Analysis**

Each project lists the type of change and the endpoints or location of the improvements. Most of the roads in the analysis were either urban or rural freeways, tollways, expressways, major arterial streets, and minor arterial streets. These are the most heavily traveled roads and the ones with the most comprehensive dataset. There were also many intersection or interchange improvements, which required a slightly different set of analytical assumptions than long road corridor projects.

### **Step 2. Calculation Factors and Equations**

Variations of procedures used with roadway inventory data to produce TTI's Urban Mobility Report were used to produce several possible congestion benefit and ranking measures. These included measures relevant to an individual traveler as well as measures quantifying the problem at a societal level. More information can be found at: <http://mobility.tamu.edu>.

There were several project types for which no congestion benefits were thought to occur. Those included:

- landscaping,
- rail yard improvements,
- right-of-way (ROW) acquisition,
- utility improvements,

- light rail improvements,
- noise walls, and
- detention facilities.

#### *Travel in the Peak Period*

The percentage of travel during the day that occurs during the peak period and, thus, might be subjected to congested conditions varies with the regional type as listed below. The daily vehicle-miles of travel on each project were multiplied by these percentages to obtain the amount of travel that will be used to estimate travel delay.

- large urban area – 50 percent of daily travel,
- small urban area – 45 percent of daily travel, and
- rural area – 40 percent of daily travel.

#### *Travel in the Peak Direction*

The directional distribution was estimated from factors in the Roadway Highway Network (RHiNo) database. Separate speed estimation equations were used for peak and off-peak travel directions (see Exhibit 1). The assumptions below were used for each roadway type.

- rural highway – 60 percent in peak direction,
- urban street – 58 percent in peak direction, and
- urban freeway – 55 percent in peak direction.

#### *Travel Speed*

Speed was used as a key factor but not as a congestion measure itself. Speed cannot be directly compared when freeways and arterials may be included in the same comparison group. The equations in [Table 18](#) provide a method to estimate speed using data readily available in the RHiNo database.



**Table 18. Daily Traffic Volume per Lane and Speed Estimate Used in Delay Calculation.**

| Facility and<br>Congestion Level          | Daily Traffic<br>Volume per<br>Lane | Speed Estimate Equation <sup>1</sup> |                        |
|---|-------------------------------------|--------------------------------------|------------------------|
|   |                                     | Peak Direction                       | Off-Peak Direction     |
| <b>Freeway</b>                            |                                     |                                      |                        |
| Uncongested                               | Under 15,000                        | 60                                   | 60                     |
| Medium                                    | 15,001-17,500                       | 70-(0.9* ADT/Lane)                   | 67-(0.6* ADT/Lane)     |
| Heavy                                     | 17,501-20,000                       | 78-(1.4* ADT/Lane)                   | 71-(0.85* ADT/Lane)    |
| Severe                                    | 20,001-25,000                       | 96-(2.3* ADT/Lane)                   | 88-(1.7* ADT/Lane)     |
| Extreme                                   | Over 25,000                         | 76-(1.46* ADT/Lane)                  | 85.7-(1.6* ADT/Lane)   |
|   |                                     | Lowest is 35 mph                     | Lowest speed is 40 mph |
| <b>Arterial Street</b>                    |                                     |                                      |                        |
| Uncongested                               | Under 5,500                         | 35                                   | 35                     |
| Medium                                    | 5,501-7,000                         | 33.58-(0.74*<br>ADT/Lane)            | 33.82-(0.59* ADT/Lane) |
| Heavy                                     | 7,001-8,500                         | 33.80-(0.77*<br>ADT/Lane)            | 33.90-(0.59* ADT/Lane) |
| Severe                                    | 8,501-10,000                        | 31.65-(0.51*<br>ADT/Lane)            | 30.10 (0.15* ADT/Lane) |
| Extreme                                   | Over 10,000                         | 32.57-(0.62*<br>ADT/Lane)            | 31.23-(0.27* ADT/Lane) |
|   |                                     | Lowest is 20 mph                     | Lowest speed is 27 mph |
| <b>Rural Highway</b>                      |                                     |                                      |                        |
| Uncongested                               | Under 5,500                         | 55                                   | 55                     |
| Medium                                    | 5,501-7,000                         | 53.58-(0.74* ADT/Lane)               | 53.82-(0.59* ADT/Lane) |
| Heavy                                     | 7,001-8,500                         | 53.80-(0.77* ADT/Lane)               | 53.90-(0.59* ADT/Lane) |
| Severe                                    | 8,501-10,000                        | 51.65-(0.51* ADT/Lane)               | 50.10 (0.15* ADT/Lane) |
| Extreme                                   | Over 10,000                         | 52.57-(0.62* ADT/Lane)               | 51.23-(0.27* ADT/Lane) |
|   |                                     | Lowest is 40 mph                     | Lowest speed is 47 mph |
| Note: <sup>1</sup> ADT/Lane in thousands. |                                     |                                      |                        |

Source: 2009 Urban Mobility Report, Texas Transportation Institute, <http://mobility.tamu.edu>

*Incident and Irregular Event Congestion*

Actual congestion will be worse than estimated with the speed equations in Table 18. The calculation procedures do not include the congestion effects of crashes, stalled vehicles, weather, events, etc. The Table 18 speed estimates are also based on average section traffic volumes—they do not include the congestion increasing effect of significant bottlenecks such as narrow bridges or tunnels. The estimate of this additional congestion was developed by applying an incident factor to the delay estimate resulting from the calculation factors above (i.e., peak period, direction, and speed).

- urban freeways (in five largest metro regions) – 1.5,
- urban streets – 1.1,
- rural undivided highways – 2.0,
- rural divided highway – 1.0,

- suburban divided highways – 1.5, and
- all other roads – 2.5.

New routes were treated as a diversion of traffic from nearby existing routes. A parallel road (or a road where traffic would shift from to the new facility) was identified. Congestion time penalties were estimated on that route. The diverted traffic volume (estimated by project planners or included in the RHiNo database) was used with the former and new congestion levels to calculate the performance measures.

### Step 3. Calculation of Congestion Measures

Several congestion measures are used to evaluate the effects of improvements. The needs of the analysis and the audience will determine which of the measures are appropriate.

#### *Travel Delay*

The total amount of extra travel time is produced by comparing the travel time at congested speeds to the free-flow speed on each roadway type. The free-flow speed was assumed to be 60 mph on freeways, 55 mph on rural roads, and 35 mph on urban arterial streets and frontage roads.

#### *Texas Congestion Index*

The Texas Congestion Index is a ratio of peak travel time to off-peak travel time. A value of 1.3 indicates a 20-minute off-peak trip takes 26 minutes in the peak period. The TCI is specified in Rider 56 as the definition of congestion.

$$\text{Texas Congestion Index} = \frac{\text{Delay Time} + \text{Free-Flow Travel Time}}{\text{Free-Flow Travel Time}} \quad (\text{Eqn. 1})$$

#### *Congestion Cost*

Two cost components are associated with congestion: delay cost and fuel cost. These values are directly related to the travel speed calculations. The following sections and [Equation 2](#) show how to calculate the congestion effects on the cost of delay and fuel consumption. This is a simplified version of the procedure used in the Urban Mobility Report. In 2007, the most recent year of data, the average cost for an hour of person delay was approximately \$21 per hour. This value was obtained by dividing the total congestion cost (\$87.2 billion) by the person-hours of delay (4.2 billion hours). This simplified estimate of congestion cost does not require data about trucks and does not require a separate fuel consumption estimate. The costs include delay and fuel for passenger vehicles and the increased operating costs of commercial vehicles in congestion. [Equation 2](#) shows how to calculate the congestion costs based on the estimate of vehicle hours of delay.

$$\text{Annual Congestion Cost} = \text{Daily Value Hours of Delay} \times \text{Value of Person Time (\$21/hr)} \times \text{Vehicle Occupancy (person/vehicle)} \times 280 \text{ Working Days} \quad (\text{Eqn. 2})$$

#### Step 4. Produce Congestion Performance Measures

A set of performance measures were calculated to identify several aspects of the congestion problems and solutions. In anticipation of a variety of needs for congestion data, these performance measures were used:

- Texas Congestion Index – The TCI is a unitless measure and only includes volume as a way to weight the segments of road. The effect of high or low volumes or shorter or longer sections are not included. Short, narrow sections of road can have the same TCI as long, wider sections with relatively low volume and the same index value. Rider 56 specified the TCI as the performance measure for congestion.
- Total delay – The best measure of the size of the congestion problem is the annual travel delay. This measure combines elements of the TCI (intensity of congestion over any section of road) with a magnitude element that prioritizes highly traveled sections above those that are less heavily traveled.
- Total delay per mile of road – One combination of a delay measure and the “indexed” approach was to divide total section delay by the road length. So the measure of “hours of delay per mile of road” indicates the level of problem without the effect of different section lengths affecting the ranking. **This performance measure was chosen to best represent the most congested segments.**
- Total delay per lane-mile of road – Another combination of a delay and an “index” measure was to divide total section delay by the road length and number of lanes. This measure removes the chosen length and width as possible confounding factors. This factor produced results that were very similar to the Texas Congestion Index.
- Total delay per vehicle-mile traveled – Another combination measure was developed to remove the effect of different lengths of section, was to divide the delay by the amount of travel on each section. This also produced results similar to the Texas Congestion Index.
- Wasted fuel and congestion cost, as well as those quantities per mile, are very similar measures with nearly identical rankings to total delay and delay per mile; for simplicity sake, the congestion cost for each section was calculated, but a separate cost ranking was not performed.

#### *Project Selection Measures*

The range of project costs and types make any project selection process difficult. Even if congestion is going to be the target, comparing small projects and large projects is particularly difficult. Small projects typically have very high benefit/cost ratios, but have much lower overall benefits than good large projects. The funding decisions should examine this issue at the program level and if possible include some element of an incremental benefit/cost analysis is performed. Such a process would rank the projects by cost, starting with the lowest cost. When the next increment of cost is less than the incremental benefit from doing the next most costly project, the new project is taken as the best; when costs exceed benefits, the new project is not accepted. The number, type, and geographic distribution of projects must also be a consideration, but the following measures may be useful in identifying a candidate list of projects.

- Project cost per hour of delay reduced – Project rankings can be calculated by estimating the cost of each hour of delay that is eliminated by the project.
- Change in congestion cost divided by the project cost – Another project ranking method is a simplified benefit-cost ratio; the change in congestion cost divided by the project cost.

For widening projects and reconstruction projects, the congestion benefits were based on the difference in operating conditions before and after the project. The same benefits were calculated in the case of new roadway projects, but the effects of diversions from existing parallel roadways were also included so that similar volumes of traffic were in the before and after cases.

Project effects were estimated by altering the incident factors. In addition to the road types listed in Step 2 above, the following changes were made to incident reduction factors.

- In the case of frontage road or ramp modification projects, additional travel time savings benefits were estimated by reducing the incident delay factor between 0.1 and 0.3 to account for smoother operations and fewer traffic conflicts.
- Widening freeways and adding direct connection ramps and interchanges – reduce main roadway incident factor from 1.5 to 1.2 for large urban freeways and from 2.5 to 2.0 for other freeways.
- Widening or dividing rural highways – reduce the incident factor from 2.0 to 1.0.
- Signal improvements on rural divided highways – reduce factor from 2.0 to 1.5.
- Other improvements on rural highways – reduce the incident factor from 2.0 to 1.5.
- Improvements to arterial streets – reduce the incident factor from 1.1 to 1.0 for signalization, divided roadway, turn lanes, and access management improvements.
- Improvements to urban freeway interchanges – reduce factor from 1.5 to 1.2.
- Urban freeway expansion in smaller metros – reduce factor from 2.5 to 2.0.

### **Analysis Considerations**

Several factors should be considered when using the statistics produced in the congestion benefit analysis:

- The analysis was designed to be used with longer segments of congested road. The analysis of interchanges, improved intersections, and direct connection ramps used the congestion level on the major roadway, rather than analyzing all roads in the area.
- The traffic volumes used in this analysis reflect the traffic that chose to use the road in the analysis. Many congested roads would have more traffic, but motorists avoid the busy route and, instead, take side streets or other corridors. In some cases, the congestion level might be higher than listed if this diverted traffic was included.
- As described above, the performance measure chosen also has some bearing on the estimated congestion level. Delay per mile of road appears to be the best measure for the purposes of creating a list of congested road segments. It removes the variability

caused by analysts' choices of segments length and relates to the extra travel time that traveler's experience. Comparing delay reduction to project cost is an appropriate project ranking metric.

- For some mobility-related projects such as rail improvements and public transportation projects there were insufficient data to estimate a direct mobility benefit. This same problem also affected some city street projects.



**WORK REQUEST ELEVEN:  
INTERSTATE 35 CITIZENS' ADVISORY COMMITTEE  
PUBLIC OUTREACH TASK**

**FOCUS GROUP RESULTS**

## *Executive Summary*

The Interstate 35 (I-35) Citizens' Advisory Committee is charged to “study the impact of corridor-wide issues, including economic, political, societal, demographic, population trends, use of existing/new/upgraded facilities, multimodal solutions and finance options; make recommendations on corridor planning, development and public involvement; and enhance participation and input between the Texas Department of Transportation (TxDOT) and affected communities, governmental entities and interested parties.” As part of that effort, the Texas Transportation Institute (TTI) was tasked with gathering public input of current and future needs of the I-35 corridor. To achieve this goal TTI conducted 12 focus groups and/or listening sessions throughout the corridor. Focus groups and listening sessions were conducted in each of the four segments of the corridor. Focus groups with the general public were conducted in rural and urban areas and listening sessions with the business community were conducted in the urban areas. [Table 19](#) indicates the dates and locations.



**Table 19. Focus Group Session Distribution.**

|                                 |                             | Location   | Urban/Rural   | Number of Participants |    |
|---------------------------------|-----------------------------|--|---|------------------------|----|
|                                 |                             |  |   |                        |    |
| General Public Groups           | Segment One                 | Dallas – TTI Dallas Office                             | Urban   | 6                      |    |
|                                 |                             | Fort Worth – Tarrant County Agri-Life Extension Office | Urban   | 7                      |    |
|                                 |                             | Gainesville – Cooke County Public Library              | Rural   | 8                      |    |
|                                 | Segment Two                 | Waxahachie – Ellis County Extension Office             | Rural   | 6                      |    |
|                                 |                             | Waco/Temple/Belton                                     | Urban   | 6                      |    |
|                                 | Segment Three               | Jarrell – Jarrell City Council Chambers                | Rural   | 12                     |    |
|                                 |                             | Austin – TTI Austin Office                             | Urban   | 10                     |    |
|                                 | Segment Four                | Laredo – Laredo Development Foundation                 | Urban   | 10                     |    |
|                                 | Business Listening Sessions | Segment One  | Dallas/Fort Worth – North Central Texas Council of Governments (NCTCOG) offices |                        | 8  |
|                                 |                             | Segment Three  | Greater Austin Chamber of Commerce  |                        | 13 |
| San Antonio Chamber of Commerce |                             |  |   | 13                     |    |
| Segment Four                    |                             | Laredo Chamber of Commerce                             |   | 9                      |    |

**Key Observations**

Comments from each of the focus groups were similar in many ways. All participants had seen traffic increasing on I-35 over the past several years. Participants in segments one, three, and four specifically mentioned the increase in truck traffic. All the participants, rural or urban, recognized the need to proactively plan for solutions. All participants agreed that Texas will continue to grow and to remain economically competitive a suitable transportation network must be provided. Most participants recognized that solutions need to be both short-term “quick fixes” and long-term. Suggestions for short-term solutions included:

- **Provide more traveler information** – Several people mentioned the need to have more information about route choices. They suggested installing and/or using changeable message signs that provided travel time comparisons with alternate routes. Participants in Central Texas were particularly interested in this. They implied that more people would use the State Highway (SH) 130 bypass if they were aware of the traffic conditions on I-35 through downtown.

- **Provide more education** – Similar to the comment above, people felt they needed more information about how to use the transportation system. This applied to all modes. For instance, people in the Austin area wanted more information about the toll roads—where they went, how to use them, how much they cost, etc. People in the Metroplex wanted more information about the high occupancy vehicle (HOV) lanes and transit options.
- **Encourage flexible schedules and telecommuting** – Many participants felt the department should do more to encourage commuting in the off-peak hours or not at all. They felt that TxDOT should work with local businesses and do targeted studies to show people what options were available to them.
- **Address the truck issue** – 18-wheeler traffic on I-35 was an issue for all groups but it was especially true from Waco south to Laredo. Everyone felt that the trucks must be addressed. In the short term, most people were in favor of the truck lane restrictions.
- **Fix design problems** – Many participants felt that TxDOT should first address things such as short ramps or ramps with curves. Many felt acceleration/deceleration lanes would help. In the Metroplex area, several people specifically mentioned the horizontal and vertical curves on I-35 and the left and right exits.
- **Begin education about transportation funding** – In every group no one had any knowledge of how transportation projects are funded. No one, except one person, knew what he or she paid in fuel tax. However, everyone indicated this information was important to the discussion of how to pay for fixes. They also suggested providing more information about how much potential solutions would cost so that the average person could do a “cost/benefit” analysis to make a better informed decision.

It was more difficult to get participants to focus on longer term solutions. It is often more difficult for people to think 20 or 30 years into the future. It is first necessary to have them accept that actual solutions will be needed. In this instance, many people suggested that technology would have solved all of the problems in 20 to 30 years. However, there were long-term solutions offered. These included:

- **Add capacity to I-35** – While this seems obvious, by far the preferred consensus for doing this was to double-deck (over or under) I-35. However, what differed was that most people felt that this option should be reserved for truly through traffic. They envisioned that this would be for people driving long distances. The groups differed on the amount of access that should be available, but in general, all agreed that it should be access that is more limited. While some people supported double-decking the entire length of I-35 others thought that where right-of-way was easily available I-35 should be widened. Where this is not possible, they preferred the double-decking idea.
- **Encourage/provide alternate modes** – Each of the groups, including the rural groups, encouraged the use of alternate modes. Participants were very supportive of HOV and even high occupancy toll (HOT) concepts. Many made suggestions for adding commuter rail or intercity rail but most did not believe this would reduce congestion on I-35. Some people suggested moving more freight by rail but quickly dismissed the idea as unfeasible.

Other parts of the discussion focused on transportation funding. As noted earlier, there was very little to no understanding of how transportation is funded and this is true at all levels.

After being given some brief, basic information, all of the participants saw the I-35 problem as much more serious than they had originally believed. The majority reluctantly supported increasing the gas tax. There was also support for toll roads, primarily in the urban areas. Most participants were shocked at the diversions that occur related to the gas tax. They also realized that it would be very difficult to stop the diversions. Therefore, while they were supportive of a gas tax increase they were adamant that it go only to transportation.

There was some consensus among the groups that TxDOT must use the money wisely. For the most part, participants felt that TxDOT was doing a good job but they want more transparency and accountability. The department lacks credibility and much more education should be done to combat the misperceptions that are perpetuated. There was also a recognition that this is a “very fine line that TxDOT must walk” so as not to be seen as advocating for any particular solution. While it was not brought up by the moderator, the Trans Texas Corridor (TTC) is still very fresh in the minds of some.

Without exception, every person in each group expressed appreciation for having had the opportunity to provide their input. They saw this as a positive move on TxDOT’s part to actively seek the public’s opinion and it strengthened TxDOT’s credibility. Additionally, nearly everyone indicated they had learned something and they were glad for having learned it. They thought that providing more information would be the key to success.

### ***Full Report***

Focus groups are an excellent method to delve into complicated issues and uncover what the public is thinking, why they think that, and how they react to additional information or alternative scenarios. The Texas Transportation Institute conducted a series of focus groups in March and April in several Texas cities designed to investigate issues related to meeting the mobility and economic viability needs of the I-35 corridor—both in the near term and the long term. This research was undertaken as part of a larger citizen-driven effort to discuss the issues related to travel on I-35 for both the general public and businesses. This citizens’ group was charged with developing a plan for I-35 that reflects the citizens’ perspective. The findings from the groups are not a statistical sample of public opinion but rather provide a broad overview of the issues that are affecting businesses and the traveling public.

A total of 12 focus groups and/or listening sessions were held within the four segments of the I-35 corridor with input from the Citizens’ Advisory Committee. [Table 20](#) identifies the type of group and the location. The original intent of the research effort was to hold one group with an urban population of each segment, one group with a rural population of each segment and at least one business listening session in each segment. However, lack of available participants precluded having a focus group in Pearsall and a business listening session in the Waco/Temple/Belton area.

**Table 20. Focus Group Session Distribution.**

|                                 |                             | Location   | Urban/Rural                        | Number of Participants |    |
|---------------------------------|-----------------------------|--|------------------------------------|------------------------|----|
|                                 |                             |  |                                    |                        |    |
| General Public Groups           | Segment One                 | Dallas – TTI Dallas Office                             | Urban                              | 6                      |    |
|                                 |                             | Fort Worth – Tarrant County Agri-Life Extension Office | Urban                              | 7                      |    |
|                                 |                             | Gainesville – Cooke County Public Library              | Rural                              | 8                      |    |
|                                 | Segment Two                 | Waxahachie – Ellis County Extension Office             | Rural                              | 6                      |    |
|                                 |                             | Waco/Temple/Belton                                     | Urban                              | 6                      |    |
|                                 | Segment Three               | Jarrell – Jarrell City Council Chambers                | Rural                              | 12                     |    |
|                                 |                             | Austin – TTI Austin Office                             | Urban                              | 10                     |    |
|                                 | Segment Four                | Laredo – Laredo Development Foundation                 | Urban                              | 10                     |    |
|                                 | Business Listening Sessions | Segment One  | Dallas/Fort Worth – NCTCOG offices |                        | 8  |
|                                 |                             | Segment Three  | Greater Austin Chamber of Commerce |                        | 13 |
| San Antonio Chamber of Commerce |                             |  |                                    | 13                     |    |
| Segment Four                    |                             | Laredo Chamber of Commerce                             |                                    | 9                      |    |

**RECRUITMENT**

Participants were recruited for nine general population sessions and five sessions oriented toward owner/managers of businesses that would be impacted by changes to the I-35 corridor. Recruitment tools included:

- flyers (see [Figures 11 and 12](#)) posted in public areas,
- past participant lists (participants used less than nine months prior were not contacted),
- online advertising such as Craigslist and EBay Classifieds (formerly Kijiji.com),
- newspaper advertisements (see [Figure 13](#)), and
- posts to Facebook groups.

WE WANT TO HEAR FROM YOU

Please Join  
Us for a

# FOCUS GROUP

5:30 P.M. to 7:30 P.M.

Date  
Location  
Address

The Texas Transportation Institute is seeking twelve individuals to participate in a focus group session discussing the Texas Department of Transportation and priorities for transportation planning along the IH 35 corridor. Eligible participants should be regular drivers over 18. The focus group will take approximately two hours and participants will be paid \$ 50.00 for their time.

For more information or to register, interested individuals should contact:

Heather Ford at (512) 467-0946 or [h-ford@ttimail.tamu.edu](mailto:h-ford@ttimail.tamu.edu)  
You must be registered to participate.



Figure 11. Sample Flyer Used for Recruitment of Participants for General Population Focus Groups.

## **Jarrell General Population**

The first focus group session was a general population session located in rural Williamson County. The emphasis for the rural communities was to recruit individuals who were not commuting into the larger cities via I-35, but rather individuals that were using it for their day-to-day activities. An ad was placed in the local biweekly newspaper, the *Main Street News*. The recruiter also sent a flyer to Jarrell City Hall and an email to Florence Chamber of Commerce for them to post the flyer on their website. The recruiter also attempted to attract participants from other rural communities in northern Williamson County. A flyer was faxed to a business in Schwertner, Texas, and an attempt was made to contact businesses in Bartlett, TX, to post the flyer.

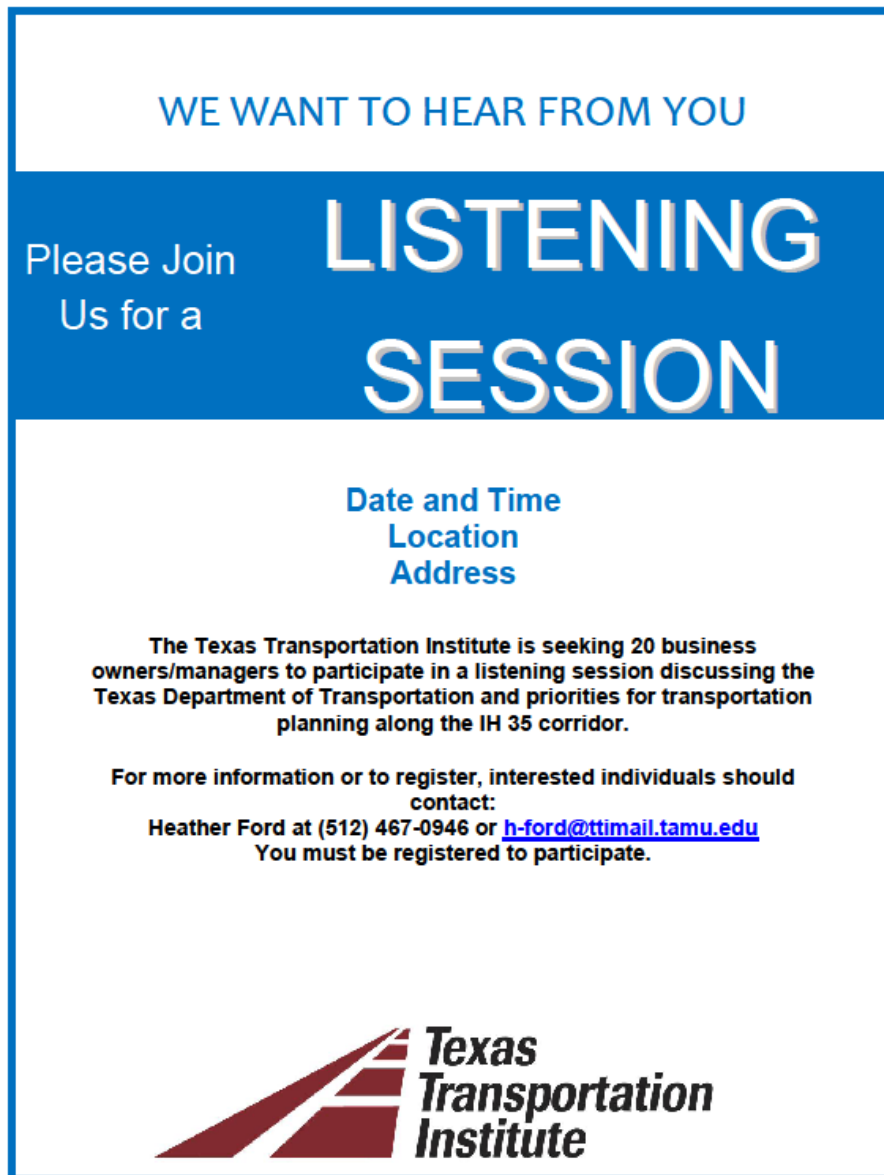
As part of the process, the recruiter posted a notice on Craigslist, but no useable respondents were recruited from that notice. All respondents to that ad were commuters into the Austin metro area (including Round Rock and Georgetown). An effort was made to recruit locals via Facebook, with an email exchange asking the moderator of the “Jarrell People” group to post the flyer information. No participants were gained from this effort. Eventually, 11 participants were recruited, at least one each from the newspaper ad, the Florence Chamber of Commerce website listing, and the flyers posted in Florence and Jarrell.

## **Austin General Population**

The recruiter had access to a number of potential contacts from previous surveys and focus groups, but was unable to fill the session with just these contacts. Several people who responded to the Jarrell recruitment ad on Craigslist, but who actually lived in Austin, were recruited to participate in the Austin session.

## **Austin Listening Session**

The recruiter worked with a representative of the Greater Austin Chamber of Commerce to recruit individual business stakeholders for the session, which was held in the Chamber’s board room. To get a representative a cross-section of businesses within Segment Three of the I-35 corridor, the recruiter also contacted Chambers of Commerce for other cities along the corridor. Georgetown and Round Rock agreed to send the information to their members. Pflugerville and San Marcos would not send out the flyer, but told the recruiter that TTI could individually contact members in their online directory. In those cases, flyers were sent to those members that appeared to have businesses that would involve regular travel on the interstate. Special invitations were sent to representatives from H-E-B and Wal-Mart, the two largest businesses in the area that use I-35 on a regular basis.



**Figure 12. Sample Flyer Used for Recruitment of Participants for Business Listening Sessions.**

### **Laredo General Population**

The recruiter had access to a list of participants from a 2006 focus group session who had indicated a willingness to participate in future research. Those individuals were contacted by email, but only two responded. An ad for the focus group was placed on Craigslist, which garnered one additional participant, and on EBay Classifieds. Most participants were recruited via an ad in the *Laredo Morning Times*, and a flyer posted on the Texas A&M International University campus. The flyer was also sent to several civic organizations, the City of Laredo, and the Laredo Development Foundation for distribution, but those efforts met with minimal success.



**Figure 13. Sample Newspaper Advertisements.**

### **Laredo Listening Session**

The Laredo Chamber of Commerce was contacted to host this listening session, and they agreed to put the listening session notice in their twice-weekly email distribution list. The recruiter also contacted the Laredo Development Foundation and Cotulla Chamber of Commerce asking them to forward the flyer to their members; at least seven individuals responded from these efforts. Due to lack of response from the Laredo Chamber posting, the recruiter also made use of an online yellow pages to contact Laredo service industry businesses that would likely make use of the interstate during day-to-day business, but received no response from this effort.

### **Dallas General Population**

The recruiter initially contacted past survey and focus group participants in the area, as well as several people who were not selected for a previous session, attracting several potential participants for the session. A posting on Craigslist garnered approximately four dozen responses in a three-day period, filling the session.

### **Dallas/Fort Worth Listening Session**

For the listening session in the Dallas/Fort Worth metropolitan area, the North Central Texas Council of Governments (NCTCOG) was contacted for meeting space and help recruiting. NCTCOG mailed out dozens of flyers to their contact lists. Also contacted were various other agencies, including the North Texas Commission, the Tarrant Regional Transportation Coalition, the Dallas Regional Mobility Coalition, and the Fort Worth Chamber of Commerce (the Workforce Development and Local Business Development groups). Several respondents indicated that they were contacted by the Farmer's Branch Chamber of Commerce, which TTI did not contact, but which was likely contacted by NCTCOG. TTI directly contacted the Carrollton, Duncanville, DeSoto, Lancaster, Lewisville, and Irving Chambers of Commerce. Also contacted were the Dallas Chamber of Commerce, Dallas Asian-American Chamber of Commerce, Dallas Indo-American Chamber of Commerce, and Fort Worth Hispanic Chamber of Commerce. Most attendees were last minute additions that learned about the session from the flyers sent by NCTCOG or from the suburban Chambers of Commerce.



### **Fort Worth General Population**

The recruiter had recently used a list of past participants in the Tarrant County area for another project, so recruited new participants for this focus group via Craigslist. Because there was a separate session for the Dallas side of the metropolitan area, it was necessary for the recruiter to eliminate a number of potential participants that lived outside of Tarrant County. All participants were recruited via this Craigslist posting.

### **Waxahachie General Population**

To attract participants in Waxahachie and the surrounding rural communities, an advertisement was placed in the April 11<sup>th</sup> edition of the *Waxahachie Daily Light*. This ad had the desired effect and received several responses from both within and around the city. In addition, the recruiter also advertised on the Dallas-Fort Worth area Craigslist page, emphasizing the rural communities in Ellis and Johnson Counties. Only one response was received from a resident of Ellis County, but several inquiries were made by Dallas and DeSoto residents, again prompting the recruiter to eliminate a number of potential participants. The flyer was also posted as an ad on EBay Classifieds, and the recruiter linked that ad to a Facebook page. Additional recruiting was attempted by contacting the cities of Waxahachie, Midlothian, Red Oak, Italy, Oak Leaf, and Ovilla. Two or three potential participants were recruited from those flyers. The Downtown Waxahachie Association and Nicholas P. Sims Library were also contacted about posting flyers, but no participants came from this effort.

### **Belton Listening Session**

The McLane Company was initially contacted for meeting space and help in recruiting, but they were unable to assist with the location due to a scheduling conflict. After making arrangements to use the Bell County Agri-Life Extension office for the listening session, a flyer was sent to the Belton, Temple, Salado, and Troy Chambers of Commerce. The recruiter also contacted the Killeen and Harker Heights Chambers of Commerce, and the City of Nolanville. The Temple Economic Development Foundation agreed to also forward the flyer to businesses on its contact list. Unbeknownst to the recruiter and researchers, another gathering of the area business community was scheduled for the same day, and only three individuals, representing one business in Salado and the Killeen Chamber of Commerce, registered for the listening session. Researchers decided to cancel this session due to the low response.

### **Belton General Population**

Past participants in the Killeen-Temple area had recently been used in a focus group for another project, so the recruiter attempted to find new potential participants by placing an advertisement in the April 11<sup>th</sup> edition of the *Temple Daily Telegram*. Response from the newspaper ad was very good, providing at least as many applicants as there were spaces available. In addition, the recruiter also advertised the session on Craigslist, receiving one response from that effort.

### **Pearsall General Population**

To recruit participants in Pearsall and the surrounding rural Frio County area, an advertisement was placed in the Thursday, April 22, *Frio-Nueces Current*. No responses were

obtained from this effort. Because there was no past participant list to work from for this area, the recruiter posted an ad on both EBay Classifieds and the San Antonio area Craigslist, specifying Frio County as the area of interest. Only one response was received, and it was from a person who lived in San Antonio who did not qualify. The recruiter also emailed and called several businesses and asked them to post the flyer in their public areas and break rooms. Flyers were faxed to several businesses that were called. After only receiving one call from a resident of Dilley, Texas, who wished to participate, the session was cancelled.

### **Gainesville General Population**

An advertisement was placed in the April 25<sup>th</sup> edition of the *Gainesville Daily Register*, which attracted several potential participants. An ad was posted on Craigslist, but most potential participants were actually residents of Denton County who did not habitually travel in Gainesville or Cooke County. Flyers were emailed to:

- North Central Texas College (NCTC),
- the Cooke County Library (the focus group location),
- the City of Gainesville, and several other local organizations.

All the remaining participants were recruited from the flyers at NCTC.

### **San Antonio Listening Session**

The recruiter contacted the Greater San Antonio Chamber of Commerce for assistance with both meeting space and recruiting. The Chamber agreed to both host the session and to send out the flyer. When they sent out the flyer, it was received by the San Antonio Metropolitan Planning Organization, and they forwarded the information to their members. As a result, there were a number of individuals representing governments, neighborhood associations and advocacy groups that attempted to register for the session. The recruiter also contacted Holt CAT and Toyota to specifically invite representatives from their businesses to attend the session. No response was received from Toyota. The Chambers of New Braunfels, San Marcos, Schertz, and other cities with businesses that regularly use I-35 were also contacted and asked to send a representative and to post the flyer.

## **FOCUS GROUP DEMOGRAPHICS**

The statistics associated with the counties in the following charts (Bell, Cooke, Dallas, Ellis, Tarrant, Travis, Webb, and Williamson) were taken from the 2006–2008, American Community Survey conducted by the U.S. Census Bureau. The statistics for towns and cities listed in the figures (Belton, Gainesville, Dallas, Waxahachie, Ft. Worth, Austin, Laredo, and Jarrell) were the statistics gathered by researchers in recruiting participants for the focus groups conducted as the main goal of this research effort.

These statistics were collected as part of TTI's screening process. For the most part, potential participants were not denied participation in the sessions. However, if researchers found that there was a great deal of interest in participating on the part of the general public, then this

information was used to construct a focus group that most resembled the demographics of the area in which the focus group was being conducted.

### Gender Demographics

In terms of gender, the I-35 focus groups were somewhat reflective of the respective county’s demographics (Figure 14). Belton and Jarrell had slightly more males in attendance, while Waxahachie, Gainesville, and Austin had slightly more females in attendance.

| <b>Gender</b>     | <b>Male</b> | <b>Female</b> |
|-------------------|-------------|---------------|
| Bell County       | 49%         | 51%           |
| Belton            | 67%         | 33%           |
| Cooke County      | 49%         | 51%           |
| Gainesville       | 38%         | 63%           |
| Dallas County     | 50%         | 50%           |
| Dallas            | 50%         | 50%           |
| Ellis County      | 49%         | 51%           |
| Waxahachie        | 40%         | 60%           |
| Tarrant County    | 49%         | 51%           |
| Ft. Worth         | 43%         | 57%           |
| Travis County     | 52%         | 48%           |
| Austin            | 40%         | 60%           |
| Webb County       | 47%         | 53%           |
| Laredo            | 50%         | 50%           |
| Williamson County | 49%         | 51%           |
| Jarrell           | 67%         | 33%           |

**Figure 14. Gender of Focus Groups’ Participants and Associated Counties.**

*Source: ACS Demographic and Housing Characteristics: 2006–2008, American Community Survey 3-Year Estimates, US Census Bureau.*

In terms of age, the focus groups were also generally representative of the respective counties (Figure 15). The main exception to this was the Waxahachie focus group, which had a larger number of younger (18–19 years old) and older (over 60 years old) participants than what might be expected in Ellis County when compared to the age demographics. It should be noted that the breakdown in age categories presented here was done so due to the fact that the Census Bureau and the TTI researchers on this research effort, collected ages within different ranges. For example, the Census Bureau collects ages in the ranges of 25 to 34, 35 to 44, and 45 to 54, while TTI researchers collected ages in the ranges of 20 to 29, 30 to 39, 40 to 49, etc. Therefore, the ranges presented below were the only possible way to compare census level data with the data collected by the researchers.

| Age               | 18 - 19<br>years | 20 to 59<br>years | Over 60<br>years | No Answer<br>/Unknown |
|-------------------|------------------|-------------------|------------------|-----------------------|
| Bell County       | 4%               | 78%               | 18%              | 0%                    |
| Belton            | 0%               | 83%               | 17%              | 0%                    |
| Cooke County      | 4%               | 69%               | 27%              | 0%                    |
| Gainesville       | 0%               | 75%               | 25%              | 0%                    |
| Dallas County     | 4%               | 79%               | 17%              | 0%                    |
| Dallas            | 0%               | 83%               | 17%              | 0%                    |
| Ellis County      | 4%               | 77%               | 19%              | 0%                    |
| Waxahachie        | 20%              | 40%               | 40%              | 0%                    |
| Tarrant County    | 4%               | 79%               | 17%              | 0%                    |
| Ft. Worth         | 0%               | 86%               | 14%              | 0%                    |
| Travis County     | 4%               | 82%               | 14%              | 0%                    |
| Austin            | 0%               | 90%               | 0%               | 10%                   |
| Webb County       | 5%               | 76%               | 19%              | 0%                    |
| Laredo            | 0%               | 80%               | 20%              | 0%                    |
| Williamson County | 3%               | 80%               | 17%              | 0%                    |
| Jarrell           | 8%               | 75%               | 17%              | 0%                    |

**Figure 15. Age of Focus Groups' Participants and Associated Counties.**

*Source: ACS Demographic and Housing Characteristics: 2006–2008, American Community Survey 3-Year Estimates, US Census Bureau.*

The Laredo focus group most represented its associated county in terms of racial and ethnic composition (Figure 16). It was attended predominately by Hispanics with a small Caucasian representation. The Gainesville and Fort Worth focus groups were also generally representative of their associated counties. The following focus groups were not representative of the general county population for the following reasons:

- The Belton focus group did not have any African American participants, which account for approximately 20 percent of the Bell County population. Caucasians and Hispanics were slightly over represented.
- The Dallas focus group did not have any Hispanic participants, which account for 38 percent of the Dallas County population. Caucasians and African Americans were over represented.
- There were no African Americans or Hispanics in attendance at the Waxahachie focus group, which account for almost 10 percent and over 20 percent of the Ellis County population, respectively.
- The Jarrell focus group did not have any Hispanic participants. Hispanics account for about 20 percent of the Williamson County population. The Jarrell focus group was disproportionately attended by Caucasian participants.
- The Austin focus group was attended by 50 percent African Americans, which only account for about 8 percent of the county population. Hispanics, Asians, and Caucasians were all underrepresented.

| <b>Race/ Ethnicity</b> | Caucasian | Black | Hispanic | Asian | Native American | Mixed | Other | Unknown |
|------------------------|-----------|-------|----------|-------|-----------------|-------|-------|---------|
| Bell County            | 54%       | 20%   | 19%      | 3%    | 1%              | 3%    | 1%    | 0%      |
| Belton                 | 67%       | 0%    | 33%      | 0%    | 0%              | 0%    | 0%    | 0%      |
| Cooke County           | 80%       | 3%    | 14%      | 1%    | 1%              | 1%    | 0%    | 0%      |
| Gainesville            | 63%       | 0%    | 13%      | 0%    | 13%             | 13%   | 0%    | 0%      |
| Dallas County          | 36%       | 20%   | 38%      | 4%    | 0%              | 1%    | 0%    | 0%      |
| Dallas                 | 67%       | 33%   | 0%       | 0%    | 0%              | 0%    | 0%    | 0%      |
| Ellis County           | 66%       | 9%    | 22%      | 1%    | 0%              | 1%    | 0%    | 0%      |
| Waxahachie             | 80%       | 0%    | 0%       | 0%    | 20%             | 0%    | 0%    | 0%      |
| Tarrant County         | 55%       | 13%   | 25%      | 4%    | 0%              | 1%    | 0%    | 0%      |
| Ft. Worth              | 43%       | 29%   | 14%      | 14%   | 0%              | 0%    | 0%    | 0%      |
| Travis County          | 52%       | 8%    | 32%      | 5%    | 0%              | 1%    | 0%    | 0%      |
| Austin                 | 40%       | 50%   | 10%      | 0%    | 0%              | 0%    | 0%    | 0%      |
| Webb County            | 4%        | 0%    | 94%      | 0%    | 0%              | 0%    | 0%    | 0%      |
| Laredo                 | 9%        | 0%    | 82%      | 0%    | 0%              | 0%    | 0%    | 9%      |
| Williamson County      | 67%       | 6%    | 21%      | 4%    | 0%              | 2%    | 0%    | 0%      |
| Jarrell                | 92%       | 0%    | 0%       | 0%    | 0%              | 0%    | 0%    | 8%      |

**Figure 16. Race and Ethnicity of Focus Groups’ Participants and Associated Counties.**

*Source: ACS Demographic and Housing Characteristics: 2006–2008, American Community Survey 3-Year Estimates, US Census Bureau.*

## Social Characteristics

Figure 17 shows a comparison of the educational attainment of focus group participants and the general population of their county. In general, focus group participants were slightly more educated than their respective county population.

| <b>Educational Attainment</b> | Less than High School | Some High School | High School or vocational school | Some college or associates degree | College Degree | Post Graduate Degree |
|-------------------------------|-----------------------|------------------|----------------------------------|-----------------------------------|----------------|----------------------|
| Bell County                   | 5%                    | 7%               | 29%                              | 38%                               | 15%            | 7%                   |
| Belton                        | 0%                    | 17%              | 0%                               | 33%                               | 50%            | 0%                   |
| Cooke County                  | 8%                    | 9%               | 32%                              | 31%                               | 15%            | 5%                   |
| Gainesville                   | 0%                    | 0%               | 0%                               | 38%                               | 25%            | 38%                  |
| Dallas County                 | 13%                   | 12%              | 24%                              | 24%                               | 17%            | 9%                   |
| Dallas                        | 0%                    | 0%               | 33%                              | 67%                               | 0%             | 0%                   |
| Ellis County                  | 7%                    | 11%              | 31%                              | 31%                               | 15%            | 5%                   |
| Waxahachie                    | 0%                    | 0%               | 60%                              | 40%                               | 0%             | 0%                   |
| Tarrant County                | 8%                    | 9%               | 25%                              | 30%                               | 20%            | 8%                   |
| Ft. Worth                     | 0%                    | 0%               | 14%                              | 29%                               | 43%            | 14%                  |
| Travis County                 | 8%                    | 7%               | 18%                              | 25%                               | 27%            | 16%                  |
| Austin                        | 0%                    | 0%               | 30%                              | 10%                               | 30%            | 30%                  |
| Webb County                   | 24%                   | 14%              | 22%                              | 23%                               | 12%            | 5%                   |
| Laredo                        | 0%                    | 0%               | 40%                              | 20%                               | 30%            | 10%                  |
| Williamson County             | 5%                    | 5%               | 22%                              | 32%                               | 25%            | 10%                  |
| Jarrell                       | 0%                    | 0%               | 33%                              | 33%                               | 25%            | 8%                   |

**Figure 17. Educational Attainment of Focus Groups’ Participants and Associated Counties.**

*Source: Selected Social Characteristics in the United States: 2006–2008, American Community Survey 3-Year Estimates, US Census Bureau.*

## Economic Characteristics

The comparison of income for focus group participants and their respective counties was problematic for the same reason that comparison of age was problematic: income was reported to the US Census Bureau in different ranges than it was reported to the researchers.

As Figure 18 shows, the I-35 focus groups were generally more likely to have lower income than their respective counties. Waxahachie and Fort Worth, in particular, had lower income levels than what would be expected based on Census Bureau data.

| Income            | Less than \$50,000 | \$50,000 to \$99,999 | \$100,000 or more | No Answer Provided |
|-------------------|--------------------|----------------------|-------------------|--------------------|
| Bell County       | 51%                | 34%                  | 15%               | 0%                 |
| Belton            | 67%                | 33%                  | 0%                | 0%                 |
| Cooke County      | 50%                | 35%                  | 16%               | 0%                 |
| Gainesville       | 75%                | 0%                   | 0%                | 25%                |
| Dallas County     | 52%                | 29%                  | 19%               | 0%                 |
| Dallas            | 83%                | 17%                  | 0%                | 0%                 |
| Ellis County      | 41%                | 36%                  | 23%               | 0%                 |
| Waxahachie        | 100%               | 0%                   | 0%                | 0%                 |
| Tarrant County    | 45%                | 32%                  | 23%               | 0%                 |
| Ft. Worth         | 100%               | 0%                   | 0%                | 0%                 |
| Travis County     | 45%                | 30%                  | 25%               | 0%                 |
| Austin            | 56%                | 22%                  | 0%                | 22%                |
| Webb County       | 64%                | 25%                  | 11%               | 0%                 |
| Laredo            | 45%                | 45%                  | 0%                | 9%                 |
| Williamson County | 33%                | 40%                  | 27%               | 0%                 |
| Jarrell           | 50%                | 25%                  | 8%                | 17%                |

**Figure 18. Household Income of Focus Groups’ Participants and Associated Counties.**

*Source: Selected Economic Characteristics in the United States: 2006–2008, American Community Survey 3-Year Estimates, US. Census Bureau.*

## GENERAL PUBLIC FINDINGS

### Austin

There were 10 participants in the Austin focus group. Participants had all been in the Austin area for some time and indicated that congestion on I-35 had worsened. Many people refused to use I-35 unless they absolutely had to. Others expressed that certain times, such as peak hours, were worse than others. None of the focus group participants carpoolled or used transit. When queried about their response to using transit, most indicated it was “not reliable,” “took too long,” “not convenient,” or other reasons. One participant said that, “if you carpool you’re still stuck in the same traffic,” indicating he would rather be stuck in traffic alone. Participants indicated that the biggest problem with I-35 was the sheer volume; although trucks were also discussed as an issue. Most people in the group were in favor of the truck lane restrictions, but all would prefer if trucks were eliminated entirely from driving on I-35. All participants inquired as to why more trucks did not use the SH 130 bypass. They expressed frustration in that they were told the road would alleviate traffic on I-35, but this had not happened.

When participants were provided information about future growth projects for this portion of the I-35 corridor many were shocked. There was an overwhelming sense of hopelessness. Many participants were unable to fathom how I-35 could be expanded to meet

these future needs. They realized that congestion was already severe and they also recognized that more people would not only impact congestion on I-35 but also on the alternate routes they already use today. They also understood that this meant truck traffic would increase too.

When pressed for solutions, many in the group expressed solutions in terms of operational fixes. These suggestions included:

- Meaningful changeable message signs that offered travelers choices. For instance, in Georgetown, there should be a sign that indicates the travel time for taking SH 130 versus taking I-35 through Austin. Other suggestions included showing alternate routes. There was frustration voiced for the changeable message signs that only show missing persons information.
- Expanded use of Global Positioning System (GPS) technologies to show traffic incidents and provide alternate routes.
- Radio updates.

Interestingly, many of the above solutions focus on alternate routes but many in the group indicated that this was a fundamental problem. They said there were not many viable alternate routes to I-35. This was doubly frustrating in regard to SH 130. Many felt they had been led to believe that building SH 130 would ease traffic on I-35. This does not seem to be the case to them. As one person put it, “the toll road doesn’t get me from Slaughter to downtown.”

Several participants expressed the need for alternate modes. They acknowledged that rail is expensive and controversial and they questioned its ability to impact traffic on I-35. Moreover, no one indicated they would use a rail alternative when traveling to other cities within Texas; e.g., Austin to San Antonio or Dallas. They all said they would need a vehicle when they reached their destination.

Some participants indicated a more meaningful short-term solution would be for the Texas Department of Transportation to engage in a “sincere” public education campaign that explained the situation and offered solutions, including current solutions such as the toll road. Many felt that more people would use the toll road if they were educated about it. A few people also felt that TxDOT should do targeted studies whereby they would collect origin-destination information and design alternatives for people. These alternatives should include routes, bus information, and carpool information. Along these same lines, many felt the state as a whole should do more to help. The state could offer incentive programs for people who carpool or use transit. The state should also consider moving state offices out of the downtown area. Some indicated a need for better coordination and planning among agencies. They felt would result in more businesses locating out of the downtown area and perhaps directed to areas around SH 130.

With regard to physically expanding I-35 many expressed doubt that it could be done, although several pointed to projects in the Dallas-Ft. Worth area that had done the “seemingly impossible” such as the North Central Expressway. Some suggested adding lanes to the elevated section. Others suggested adding HOV lanes. Many felt that this was a prudent idea because it still promoted alternate modes while providing for more capacity. One person suggested

charging a toll to enter downtown. Everyone liked the idea of managed lanes whereby if a person were willing to pay a toll that option was available to them. However, the group, as a whole, did not have many ideas for expanding I-35.

When questioned about transportation funding, most participants were unaware of how or how much gas tax was collected. Although there was initial reluctance to any form of increased taxation or toll payments, by the end of the discussion all recognized the need for additional funding and were willing to pay a small increased gas tax. They also offered several other ideas for generating revenue, including:

- charging a fee for new residents;
- assessing impact fees for new development, rated depending on location;
- charging fees for entering downtown;
- paying for fixes through taxes;
- raising the gas tax;
- imposing sin taxes;
- charging taxes for rental cars and hotels;
- increasing payroll taxes for businesses located in the downtown area; and
- raising registration fees.

## **Jarrell**

There were 12 participants in the Jarrell focus group. Most of these people had been in this area for several years. Most considered their lifestyle to be very rural. The people in this group perceived the problems on I-35 to be north of Round Rock through the Austin area. Like the urban Austin group, this group tended to avoid travel on I-35, particularly at certain times of the day, i.e., peak periods. However, many noted that traffic on the weekend could be just as bad as peak travel times.

Several people in this group expressed concern over the expanding urban areas and the threat this poses to a rural lifestyle. There was considerable discussion of a “suburbanization” of rural areas. Many felt that the “taking” of agricultural lands out of production would cause long-term problems. They expressed a desire for more coordinated control over development.

Many participants offered short-term solutions for addressing congestion on I-35 and most felt that these issues should be addressed before planning for new and/or expanded corridors. These included:

- Increasing law enforcement.



- Adding HOV lanes.
- Encouraging alternative work schedules and telecommuting.
- Moving more freight by rail.
- Instituting more truck restrictions such as limiting travel to nighttime hours.
- Fixing bottlenecks in Round Rock/Austin.
- Extending acceleration/deceleration lanes.
- Installing changeable message signs that indicate travel times on alternate routes, especially comparing SH 130 to I-35. This would allow travelers to make informed decisions about taking the toll road.

This group had no knowledge of transportation funding or how roads are funded. There were several misperceptions of the toll roads in operation in the Austin area. All 12 people in the group were under the impression that these toll roads were owned by foreign, private companies. When this misperception was clarified, responses included, “well, if I had known that, I might use them.” This points to the need for more education.

When information was provided to the group about current transportation funding there was some discussion regarding “wasteful” spending and the ability to “streamline” processes to use the money more efficiently. One person indicated that he knew people that worked at TxDOT and he did not believe there was much “slack” at the department.

When prompted for solutions to increase transportation funding, some responses included:

- assessing fees for new residents;
- raising local taxes and fees;
- streamlining agencies, better management of existing resources – remove pork;
- stopping diversions;
- increasing gas tax and directing it only to transportation; and
- stopping outsourcing and hold TxDOT accountable.

There was no clear consensus in the group on how to provide for the funding shortfall. There was skepticism that money was being used appropriately. This group was more supportive of raising the gas tax and directing it only to transportation than building additional toll roads.

## Laredo

Ten people participated in the Laredo focus group. All expressed concern, but mostly the biggest issues were outside of Laredo and dealt with traveling along the I-35 corridor into Austin. By far, the largest issue in the Laredo area was the amount of truck traffic. Many expressed a desire to get trucks off of I-35, although no one offered a solution on how to accomplish this. A few thought that Loop 20 was supposed to keep truck traffic moving around town but it does not seem to have done that. Several people suggested moving more freight by rail but others complained that the train traffic was already too bad and caused vehicular traffic to become congested.

There was a strong sentiment in this group that the Laredo area and south Texas were not getting “their fair share” of highway funding. They recognized that other larger cities get more money because they have a larger population but they also expressed frustration that population was the only criterion used to distribute funding. Many thought that truck percentages should also be factored into that calculation.

By and large this group had a harder time imagining how congested I-35 might become in the future. They recognized that the area was growing and would continue to grow but they were not currently experiencing severe or even bad congestion. Their biggest concern was providing more law enforcement and incident management. Some people had issues with signage, suggesting that signage be in both English and Spanish. Others expressed concern over design issues.

When pressed for solutions to I-35 most expressed them from a point of view as if traveling across the state. There was considerable support for developing a “super-duper” highway that goes around or over cities—straight from Laredo to past the Metroplex. There was also support for establishing separate facilities for trucks, but many did not know how this could be accomplished. There was minimal support for establishing intercity rail. Some thought it would be a good idea for tourists but wondered about the need for transportation at the ends of the route.

As with the other focus groups there was little to no knowledge of transportation funding or financing. Most people thought the gas tax was a percentage of the purchase price. Possible solutions for additional funding included:

- charging tolls for bypass roads;
- increasing vehicle registration fees;
- cost-cutting by TxDOT, “putting the little bricks and fancy decorations on overpasses seems like a waste and are not needed”; and
- charging developers more for transportation impacts.

There was considerable discussion regarding an increase in the gas tax. Most people would be supportive of a gas tax increase but were fearful that the money would be diverted to other parts of the state. The moderator then asked about a local option gas tax. The participants

were very much in favor of this option. There was also surprise expressed at the diversions that occur and many suggested that TxDOT get this money back. They expressed frustration by saying there were told the lottery was paying for education yet there is a diversion of fuel taxes to the Permanent School Fund.

### **Waxahachie**

Six people participated in the focus group held in Waxahachie. Most of the participants had been in the area for several years. When queried about their travel on I-35 most indicated that they have seen traffic getting worse over the years. A majority did or currently do travel on I-35 to the Metroplex area for work or school. One person specifically mentioned that traffic was worse in the peak periods, but two others indicated that weekend travel could be just as bad. They have appreciated the expansion that had occurred but lamented the construction headaches it caused. A few also expressed concern for displaced businesses.

This group's first and most agreed upon solution for the I-35 corridor was to build HOV lanes, but it later became apparent that they meant express lanes because they did not feel there should be an occupancy requirement. Rather, they wanted a lane or lanes that were truly for people that were going through the area. They suggested severely limiting the access. Some expressed that that was the purpose of the left lane of the interstate.

When pressed to discuss the biggest problem with I-35 the group said that it was both traffic congestion and truck traffic because the trucks contributed to the congestion.

When the projected growth information sheets were distributed most people initially expressed shock at the population projects but then gradually accepted that the projections were probably accurate. Once again the issue of trucks was raised because people asked how goods would be transported for all the people. Most did not think rail was being very widely used nor did they think it was a viable alternative because, "tracks don't always go right behind the warehouse, especially in this area; it's so rural." A few people expressed concern over "big-box" stores and their need for just-in-time-inventory.

There was strong support for having an intercity passenger rail. Most people felt they would use this option when traveling throughout the state for recreational purposes. They also felt passenger rail would alleviate traffic congestion on I-35. They suggested the need for having "local" and "express" service where the local service would stop at most of the little towns along the way and the express service would only stop at major cities.

When the group was pressed for solutions to solve traffic congestion on I-35 most agreed that additional roadway capacity was necessary. However, there was disagreement on how this would be accomplished. Some preferred building a bypass while others preferred a double-decking alternative. Still others suggested that no alterations could be made to I-35. Overall, there was very little consensus. Most of the participants liked the idea of having a bypass for through traffic, including trucks; they were just unsure of whether that should be added to I-35 or on a new location. In both cases they recognized that a solution would be very expensive.

Regarding transportation funding, one person in the group knew that fuel taxes pay for the bulk of the transportation improvements. This person also brought up the issue of the other large counties in the area—Dallas, Denton, Collin, and Tarrant—and the air quality issues facing the entire Metroplex. She informed the others that it would be very difficult to get funding in Waxahachie if they were competing with these other counties.

No one knew the last time the gas tax was raised but when they were told it had been almost 20 years one person reasoned that it was because gas prices were already so high. After discussion, all of the participants agreed that raising the gas tax a few pennies per gallon would be acceptable to raise revenue. The group also supported toll roads and was especially supportive of a high occupancy toll (HOT) concept. They thought that would be a reasonable way to pay for a bypass or double-deck through the Metroplex.

### **Waco/Temple/Belton**

There were six participants in this focus group that was held in Belton, Texas. The people in this group stated that they have seen traffic congestion increasing over the past several years but the biggest concern with I-35 currently was related to the design. All the people lamented the lack of acceleration/deceleration lanes in most of the areas between Salado and Waco. They did appreciate the new construction underway in the Temple area. Many also saw truck traffic as a major issue, stating that it had increased substantially. However, while they indicated that traffic congestion was increasing, they felt that at this point in time it was still moving. Several people compared it to traffic in Austin or Dallas that they said was “just horrible” all the time.

When the moderator presented the future conditions information, there was considerable discussion about how the numbers were calculated and if they were accurate. After the discussion the participants all agreed that the information seemed reasonable. There were question as to why the level of service (LOS) in Segment Two did not change much over the 20-year period. The moderator explained that the analysis included many planned projects. Eventually, all agreed there was a need to accommodate future growth and traffic on I-35.

The moderator asked the participants for their potential solutions to meet future needs. A few people had a preference for high speed rail (HSR) that would run parallel to I-35 from Dallas to San Antonio. Most of the other participants disagreed with this approach stating this would not relieve commuting traffic on I-35 between Waco and Austin. However, they said it could possibly be used for business travel instead of flying. One person suggested a “ferry” style rail where you could load your car and take it with you. Everyone supported this idea. With regard to trucks, some people said they should use rail but others questioned the time required to do that, stating concerns about perishable goods. One person mentioned having a separate highway for trucks; others mentioned separate lanes for trucks.

After more discussion everyone agreed that more lanes need to be added and a rail option developed. When asked if the lanes should be on I-35 or on a separate facility, most participants indicated that lanes should be added to I-35. However, they also suggested building a new facility—a double decking of I-35. HOV/HOT lanes were not a viable option for this group. Other possible solutions included:

- allowing longer combination trucks (double 48s and triple 48s),
- separating truck traffic from other traffic,
- improved incident management, and
- using changeable message signs that alert drivers of accidents and also having travel time comparisons between I-35 and toll roads.

No one in the group had any knowledge of transportation funding. No one knew the amount of gas tax that was charged. They immediately began accusing big oil companies of making more profits and suggested that any shortfall be paid by the oil companies. After more discussion, everyone agreed that more money is needed but they also felt that they were not getting their “fair share.” They believed that more money was going to the big cities even with the projects that were currently under construction in the Waco/Temple area. When pressed for other funding options, possible solutions included:

- instituting income tax on new residents,
- raising the gas tax,
- getting oil companies and car companies to pay more, and
- building toll lanes for through traffic.

In the closing discussion most participants acknowledged that there is no one single answer but that there needs to be several solutions. There was a strong sentiment that the government (TxDOT was not singled out) needs to fix itself before it could be trusted to fix anything else—like transportation finance. Some felt the government was wasteful and not doing what was necessary to address these issues in a timely manner.

## **Fort Worth**

Of the seven participants in the Ft. Worth focus group, all but one indicated that traffic congestion on I-35 was bad and that it was getting worse. Many commented that it had increased substantially in the last 10 years. Several people indicated that I-35W was becoming increasingly congested and that it should be expanded very soon. There was considerable discussion over signage in and around the downtown Dallas area. People indicated that the right and left exits were confusing and dangerous. The biggest issue for the group was travel time reliability rather than congestion. Everyone in the group traveled in single occupant vehicles. However, many participants expressed a desire to carpool but said it was not a workable solution for them. Most said the transit system was unreliable in both Dallas and Ft. Worth but they enjoyed the light rail in Dallas.

This group had several complaints about the maintenance of the roads they traveled on daily, like I-35 and I-820. Many expressed concern with potholes that go unrepaired and bad pavement. The group agreed that trucks were also a big issue, especially on I-35W. Everyone

agreed that it was because the entire Metroplex area was growing. Some expressed concerns that it seemed as if “everything has been under construction since 1969.”

Everyone in the group agreed with the population projects over the next 25 years. When prompted for possible solutions, their answers included:

- fixing existing geometric problems; e.g., smoothing out bumps, fixing horizontal and vertical curves so that average speeds increase; and taking out left exits;
- adding lanes;
- offering incentives for carpooling and public transportation;
- instituting disincentives for driving such as road taxes, higher fuel costs, or tolls;
- adding HOV lanes in the Ft. Worth area;
- encouraging telecommuting;
- making ridesharing more accessible through social networking;
- charging a fee to enter downtown Dallas; and
- applying technology solutions such as automated driving that would allow more cars on the roadway.

There was concern with adding lanes in already developed portions of the community because in many instances the housing that would be displaced was low-income housing. Everyone in the group was supportive of the HOT lane concept, especially pointing out the convenience of having a choice.

After much discussion of adding lanes versus building an alternate facility, the group came to a consensus that it would make sense to build an alternate facility for truly through traffic. It would be a very limited access facility yet still be in close proximity to I-35, perhaps even a double-decking scenario.

This group was slightly more knowledgeable about transportation funding than the other groups but there were still many misperceptions. Everyone was surprised that the state gas tax had not been raised in almost 20 years. There was also shock at the diversion to the Permanent School Fund. After considerable discussion about the gas taxes and what they pay for everyone agreed that there is a need for increased funding.

This group was very forward thinking and realized fairly quickly that even with a gas tax increase this would not be sustainable into the future, although it would be helpful in the short term. They suggested a different taxing structure, something like an energy tax. The moderator suggested doing away with a tax altogether and asked for the group’s opinions on a fee based on miles driven. There were a lot of questions about how it would be calculated or enforced.

Several recognized that this could get people to change their driving habits. Overall, the group was supportive of this idea. Other mechanisms for providing funding included:

- highway sponsorships,
- index the gas tax,
- base the amount you pay on the number of cars you have,
- institute another fee based on income, and
- HOT lanes.

At the conclusion of the group session, every person mentioned how much they had learned and had a sincere appreciation for being able to provide input. Many commented that it had completely changed their way of thinking about roads and transportation in general.

## **Dallas**

All six participants in the Dallas focus group had similar experiences to the Ft. Worth group on their travels on I-35. They had several comments about the accidents that occur and all expressed frustration with lanes changing from three or four to two or three. They also expressed unhappiness with the signage, lane markings, and the varying exits—left or right. Many said they try to avoid traveling in the peak period, or they use alternate routes to avoid I-35. No one in the group carpoled and two people had used transit very infrequently. Some people also commented on the poor pavement condition. There were mixed reactions on whether or not trucks were a big issue on I-35. Some people indicated they saw a lot of trucks while others said they were more prevalent on other interstates in the area.

When the projection information was conveyed, no one was surprised with the population growth predicted. A few people indicated that the rail system was helpful in removing cars from I-35, although no one in the group used it. The group also felt like the park and ride lots were useful to commuters.

To accommodate the projected growth, the first idea posited by the group was to double-deck I-35 or US 75, going both north and south from downtown. However, then they thought that the first solution would be to make the number of lanes consistent on I-35 throughout the Metroplex. After more discussion, the group decided they liked the double-deck idea the best because they said they already have three loops around the area and they do not work. One person raised the question of what the double-deck would actually be used for. All agreed that it should be used for through traffic. However, this group suggested interchanges at major highways. This group was also supportive of adding intercity rail lines, but they also recognized this would not alleviate commuter traffic.

When prompted for ideas on financing their potential solutions, several people mentioned legalizing gambling. The entire group was supportive of making the double-deck a tolled expressway. They wanted to see the diversions ended but did not think that was very likely. They reluctantly agreed that a small gas tax increase was acceptable but only if the money were

dedicated to transportation. This group was not supportive of any type of congestion and/or variable pricing.

### **Gainesville**

There were eight participants in the Gainesville focus group. Their biggest concern on I-35 was traveling into the Metroplex area and most avoided this if at all possible or traveled during the off-peak period. One participant leaves his home at 3:30 in the morning to get to the other side of Ft. Worth before rush hour and then stops at a rest area and naps before going to work. Most thought the problems with I-35 were as you approached Ft. Worth on I-35W. There was also concern about the “crooks” in the entrance and exit ramps. This group also complained about right and left exits and poor signage.

The participants all agreed that traffic congestion was increasing and many refused to travel back into the Metroplex for evening events because “it isn’t worth the effort.” All agreed that I-35 should have already been expanded. They especially pointed out increased traffic to the casinos in Oklahoma. Two people in this group regularly carpool. One person takes a bus to Las Colinas. Most people felt that improved transit would relieve congestion on I-35. Several people were very complimentary of the bus service offered by the University of North Texas and felt this was doing a good job of keeping cars off of I-35.

Most of the participants agreed with the population projections and pointed to Denton as a perfect example. When the moderator asked for potential solutions some stated ideas included:

- giving subsidies for smart cars as they take up less roadway space and travel at slower speeds,
- double-decking I-35,
- building more toll roads, and
- improving acceleration/deceleration lanes and ramps.

By far the most agreed upon solution was double-decking I-35 because they thought no additional right-of-way would be needed. A few suggested having trucks use the upper deck and commuters the lower portion. Like the majority of the other groups, this group suggested using the double decked portion as a throughway facility with very limited access. Some even suggested including facilities such as service stations on the facility itself and pointed to New Jersey and Kansas turnpikes as examples. Others supported the idea of a bypass facility but they were concerned that it would not be useful for commuters. They heard this was the problem with the toll road in Austin—that it was too far out of the way.

When pressed for the preferred solution, the group confirmed that they preferred adding lanes to the existing I-35 corridor whether that was “up or down or out.” They did not want anything that would require the taking of land like the Trans Texas Corridor.

Most of the group was supportive of toll roads for funding improvements. One person knew that transportation was funded primarily with the gas tax. This same person also knew that



one quarter of the amount collected went to the Permanent School Fund. One person questioned the cost of improvements they were considering. He indicated he needed that information in order to make an informed decision.

One person suggested a road improvement tax or a “privilege tax” whereby new people moving into the state would pay a substantial fee to register their vehicle. Another person indicated that this would be bad for the car sales industry. Most people in the group liked tolling. A few people acknowledged the affect that traffic congestion could have on the economies of large cities. They said that other solutions such as transit options are needed there.

In general, this group also indicated there would not be one solution but that it would take a combination of things to improve conditions and accommodate future growth. Transit options were especially important. The bottom line was that they recognized that something must be done sooner rather than later and they were willing to do whatever it takes to finance it.

## **CONCLUSIONS**

After conducting the eight general public focus groups, a few things become very apparent and several common themes were found. People in urban areas see I-35 as more congested than the people in the rural areas. Nevertheless, the people in the rural areas recognized that as more cities become more congested more people will be moving to more rural areas and this would impact their travel on I-35 as well. For the most part, most participants had firsthand knowledge of traffic congestion getting worse on I-35 over the last several years. There was considerable concern over what people noted as an “out-dated” facility. This included:

- lack of acceleration/deceleration lanes,
- short entrance and exits,
- bad geometric design with too many vertical and horizontal curves (primarily in the Dallas-Ft. Worth area), and
- lane markings and signage.

Participants were aware of and appreciated that Texas and cities within Texas will continue to grow. In fact, several groups noted that even with the economic downturn Texas is still thriving compared to other states. There was an acknowledgement that I-35 is vital to the state as a mobility and economic corridor and that problems must be addressed. Many felt that problems should have been addressed long before now.

Trucks were an issue for all of the groups but they were of particular concern to the groups from the Waco area south. These areas have seen steady increases in truck traffic. At the same time, nearly everyone was supportive of truck lane restrictions. The only exception to this was the few truck drivers that were in the groups. They neither supported nor disagreed with the restrictions. Many people were supportive of separate lanes or entire facilities for truck traffic.

The solutions for meeting the future needs of I-35 by the group could be categorized into short-term (operational) and long-term improvements. Interestingly, nearly every group questioned why TxDOT did not provide more traveler information. Many people expressed a desire to have more information about travel choices whether they were route choices or mode choices. These ideas ranged from:

- providing travel time information comparing travel on I-35 to toll roads;
- providing information about lane closures and accidents;
- providing more information on transit options
- providing more information on how to use HOV lanes; and
- providing more information on routes, rates, and how to use toll roads.

Other short-term solutions included an educational campaign that focused on TxDOT—what the department does, what they are responsible for, how they are funded, and information about the gas tax. Essentially, all the focus group participants were misinformed about one aspect or another of the department and its responsibilities and funding. They appreciated receiving this information and all felt that others would benefit from knowing this information. The Austin group in particular, however, recognized the sensitivity with which this information would have to be imparted. TxDOT must “walk a very fine line” so as to not be seen as advocating for a particular solution, “like they did with toll roads and the Trans Texas Corridor.” However, nearly everyone felt that it was the department’s responsibility to educate. They also felt that the education must extend beyond highways and that more multimodal solutions and information should be part of an educational campaign.

The more long-term solutions included expanding highway capacity. The most popular way to do this amongst every group was to double-deck I-35; although the participants in the Austin focus group did not think this would be possible. Some went as far as to say the entire interstate from Laredo to Oklahoma should be double-decked. Others suggested double-decking (either over or under) where the highway could not be widened. Almost all the participants wanted this alternate route to be reserved for vehicles that were traveling long distances—in essence a true throughway. The groups varied in how limited the access should be with the folks in more rural areas and in Laredo suggesting more limited access. Perhaps this response is because they are used to traveling longer distances.

With regard to rail alternatives, while most people supported rail of all types not many people thought it would be effective at relieving day-to-day congestion on the I-35 corridor for both commuters and moving freight. They were more supportive of intercity commuter rail that would allow them to travel from Dallas to San Antonio, but primarily for recreational purposes. Most participants questioned the ability to get around once they reached their ultimate destination. They did not believe that the terminal cities had adequate public transportation to meet their needs.

Moreover, most people did not feel that rail could meet the needs of good movement throughout the state. They felt that there were not enough rail lines to accommodate the amount

of goods that needed to be moved. They also questioned what would happen when freight got to a destination, stating that it would “still have to be moved to the stores” and they thought that intermodal shipments would increase the cost of goods.

Several participants in the urban groups brought up the high cost of rail. People in the Metroplex thought that the Dallas Area Rapid Transit (DART) had done a good job in building its rail system and that it was somewhat effective in relieving congestion. People in the I-35W corridor wished they had a rail option and indicated that they would use it. However, in Austin, people complained that rail in this area did nothing to relieve congestion on I-35 and that it was too expensive.

Without question, in every focus group there was little to no understanding of transportation finance. All agreed that more education must be provided. Especially in the urban areas, the participants wanted to be able to make more informed decisions. In order to do this they wanted to know the relative cost of potential solutions and how the current funding could accomplish this. In effect, they wanted to know, for instance, the cost of double-decking I-35 through Fort Worth and the time it would take to do this based on the different types of financing used.

Without exception, every group voiced their appreciation for being able to provide an opinion. Additionally, every group suggested they had learned a lot by participating. Many mentioned the trust and credibility that must be rebuilt in order for the public to have faith and confidence in the department’s ability to deliver projects. All felt that this effort went a long way to improving the public’s confidence.



## *Appendix A: General Public Focus Group Script*

### **I-35 Citizens' Advisory Committee Public Opinion Research**

#### **Part 1 – Sign Consent Forms (prior to beginning of focus group) – 5 minutes**

Participants will be asked to read and sign a consent form that has been approved by the Institutional Review Board at Texas A&M University. Participants will also be invited to enjoy beverages and snacks.

#### **Part 2 – Welcome and Introductions – 15 minutes**

Welcome to the focus group today. Thank you for taking time out of your busy schedules to talk with us. I'd like to begin by telling you about how the group will work and then we'll get down to the specifics of our topic for the day.

How many of you have participated in a focus group before? What do you think the purpose of the focus group is?

The success of the group depends quite a bit on how willing you are to share with us what you think. So, I'm asking you right up front to be open and forthcoming, and not to worry about what I might think, or what others in the group might think about what you say, or even if you are giving a viewpoint that disagrees with someone else's. We're not really talking today about matters that would be considered very sensitive, but the topic is one that we would expect people to have differing opinions on, so I do want to encourage lots of dialogue. Don't worry about the tape recorder. We will keep the tape to ourselves and just use it to help us with our notes. Try to forget that it's there. Let me assure you that we will always keep everything you say anonymous.

Having said that, I want you to relax and enjoy the conversation. But I do have to ask that you talk one at a time, that you not have any side conversations, and you speak loudly so that everyone can hear what each person has to say. I don't expect our discussion to last more than about an hour and a half or so. If you need to get more refreshments or use the facilities around the hall, please feel free to get up at any time.

First, I'd like us to have some brief introductions. I'll start with us...

Now, let's go around the room and say your first name only (because we're keeping this anonymous), and a little bit about who you are, how long you have lived in the area, and what you do for a living.

---

OK, now we're ready to get on with the topic at hand. TTI is working with the Department of Transportation to get your input on issues related to I-35. This effort is part of a larger citizen-based effort to discuss the issues related to travel on I-35 for both the general public and businesses. This citizen's group is charged with developing a plan for I-35 that reflects the citizens' perspective. They and TxDOT want to know what you think.

**Part 3 – Current Perceptions – 30 minutes**

I want to spend just a few minutes asking you about your travel on I-35.

How often do you travel on I-35?

How would you describe this experience?

Has it gotten better or worse over the last 5-10 years? How so?

How many miles do you spend commuting?

How much time does this take you?

Do you travel by yourself in a car or do you travel by other modes such as bus, train, carpool, or vanpool?

If other modes were available to you, would you use them? How so?

What modes are of interest to you?

What do you think is the biggest problem with I-35 today?

*Prompt for truck issues if needed.*

I have some handouts that I'd like to share with you about expected growth in this area (**handout population and demographic information sheets for each segment**).

What do you think about these projections? Do you agree with them? If not, what do you disagree with?

Does anything about them surprise you?

**Part 4 – Future – 40 minutes**

Assuming that you do agree with the expected population projections, I want to talk now about how we can accommodate this growth.

What do you think should be done to solve the problems of I-35 in your area?

*Prompt if needed.*

*Would you add lanes? If so, where, how?*

*Would you create an alternative or parallel facility? If so, where would it be located? What would it look like?*

*What about solutions that help move people and cars more efficiently (HOV/managed lanes, ramp metering)? Other strategies?*

*Would you consider rail? What kind (intercity passenger, commuter/regional rail, light rail, freight rail)? We won't explain the different kinds of rail at first. We'll see if the participants know the difference.*

*Some people have suggested building new freight rail lines that could be grade separated and move more freight by rail instead of by trucks on I-35. That could make existing rail lines going into the cities available for passenger service between cities along I-35. Would you be supportive of something like that?*

*How would these fixes be paid for? Talk a little about the current funding and the estimated needs (from 2030 report).*

*What would you be most supportive of? (increase in gas tax, local option gas tax, increase in general taxes for transportation, local option sales tax for transportation, VMT fee, toll roads; increase in vehicle registration and inspection fees; increase in auto rental tax; surcharge on tires, batteries and other road use items; auto maintenance/repair surcharge such as oil changes and vehicle repair, etc.).*

## **Part 5 – Implementation (Time Permitting)**

Who or what agency do you think handles projects like this?

Who or what agency funds these projects?

Is your local government involved in any way?

If so, who?

If you wanted to support or oppose these efforts how would you go about it?

How do you get the public involved?

Do you think anything will ever really be done?

If not, why not?

If so, when?

What is the basis of your time frame?

**Part 6 – Final Remarks – 5 minutes**

Again, I want to thank you for your time and participation. I want to give everyone a chance to say any final comments.

**Part 7 – Have participants sign payment sheet and distribute \$50.00/person.**



## *Appendix B: General Population Focus Group Session Notes*

### **March 8, 2010, Jarrell, TX**

Moderator: How do you use I-35?

- One participant stated that they often traveled south on I-35 to San Antonio to visit family. This person noted that I-35 south of Austin was amazing and that it was generally “smooth sailing” to San Antonio after Austin.
- Another participant agreed that the main problem in the area is in Austin.
- Another participant stated that problems generally begin north of Round Rock and continue into Austin.
- One participant stated that they traveled into Austin about 3 times a week but that they were generally traveling in the opposite direction of major traffic.
- Another participant stated that traffic in Austin is so bad that they generally tell their drivers to use the toll road.
- Another participant stated that they like to use the toll road to get around Austin and that on Friday it is the only way to get around Austin without traffic. This person noted that they have observed accidents on I-35 on numerous occasions and have often sat in traffic for upwards of 45 minutes. This person also stated that weekend travel on I-35 through Austin is also unreliable.
- Another participant stated that they have encountered congestion on I-35 through Austin at 3 AM.
- One participant stated that the three lanes north of Round Rock on I-35 are really nice to have.
- Another participant stated that construction along the I-35 corridor does not appear to be “coherent.” This person stated that exits are generally too short (although they noted that they are getting better). This person also stated that the two way frontage roads, particularly in Salado, are very dangerous.
- Another participant echoed this sentiment by stating that the entrance ramps at FM 2222 and Oltorf in Austin are very bad for trucks. This person stated that they work in the trucking industry hauling pavement materials and have worked along I-35 from Waco to San Antonio, and that traffic never seems to get any better.
- Another participant inquired as to why development in the I-35 corridor (in terms of road construction) has occurred at such a slow pace, while the area toll roads were constructed very quickly. (The moderator stated that was due mainly to toll financing on the tolled facilities that allowed them to be built relatively quickly.)

- Another participant, who was a retired truck driver of 33 years, stated that they had driven all across the US and Canada and they did not believe that restricting truck traffic from driving in the left lane did not help traffic flow. This person stated that oftentimes passenger cars merge onto the interstate and drive for only a few miles before exiting, and that trucks should be allowed use of the left lane so as to avoid these vehicles completely. Responses to these statements included the following:
  - One participant stated that they favored speed limits for large trucks, as they are more dangerous due to their weight.
  - Another participant stated that the danger comes from passenger vehicles not respecting the “physics” of large trucks.
- A participant stated that they were under the impression that trucks could use the SH 130 toll road, but that they never saw any truck traffic.
  - In response to this, another participant stated that the road has not been completed to Seguin, and that there may be more use by trucks when that section is completed.
- One participant noted that the Jarrell area on I-35 is one of the most dangerous stretches of road in terms of accidents on a per-capita basis. This was attributed to poor law enforcement coverage. This participant stated that safety is one of the biggest issues in the area. For example, they stated that a new on-ramp is needed before “Texas Star” because emergency vehicles often have to travel too far down the highway and turn around to reach certain areas.
- One participant stated that their company can only use the toll road if it is a financially viable option, and that given the bad economy, that is not often. This participant suspected that this is the same for other transportation based companies in the area.

The moderator asked the group if they viewed trucks as one of the biggest problems in the area. A few participants indicated that it was, but several others disagreed.

- One participant stated that there are not enough lanes in the area, while another stated that the lack of mass transit and other travel options are the biggest problems in the area.
- One participant stated that in the 1970s, the Austin City Council had a zero-growth stance, which resulted in the current situation with regard to regional bottlenecks. This participant stated that they hate toll roads, as they have “already been paid for,” and that they feel like it is a “slap in the face” every time they see one. This participant stated that they have taken an area toll road once, and it was only because Burnet Road came to a dead end at one.
  - Another participant stated that they, too, do not ever use the area’s toll facilities.
- Another participant agreed that there was never a plan to keep up with growth.

- One participant stated that it is very difficult and expensive to acquire right of way (ROW) in the I-35 corridor's problem areas, especially through the downtown Austin area.
- Another participant stated that they do not like the way area development is proceeding and noted that facilities like Ronald Reagan Boulevard are cutting off access to land for area ranchers and farmers. This participant stated that they are "sick and tired of people turning land into cities" and profiting from it.
  - Another participant stated that to these "people" that type of development is progress. This same participant argued, however, that landowners need to quit selling their land to developers. The problem, they went on to state, is that without "big bucks" there is nothing that anyone in the area can do about development.

The moderator next asked if any of the participants carpool or use mass transit.

- A few participants indicated that they occasionally carpool and one stated that they use transit in Leander. This same person stated that high speed rail may be the answer and that HSR moves a lot of people and light rail does not. This person stated that they would like to have a line running from their area to Austin and San Antonio similar to Amtrak.
- Another participant stated that rail like that is good if it is going where you are.
- The participant who advocated for HSR stated that Cap metro has done a poor job of planning, as their son has to travel all the way downtown from Leander to catch a bus to Austin Community College's North campus.
- One of the participants stated that they were from Phoenix, and that the city there has built too many freeways without planning for growth. They stated that Phoenix is now looking to further develop their transit options but due to poor highway planning the buses are not "mixing well" with general purpose traffic. This participant stated that the area here "is heaven" compared to Phoenix.
- Another participant agreed that the Central Texas area does not have the problems of larger urban areas such as Los Angeles but that things are getting worse in the area. They noted that it used to be "smooth sailing" through Round Rock, but not anymore.

The moderator asked the group if there was a viable alternative would the group members use it.

- The majority of participants said yes.
- One participant stated that the problem with transit is "getting around once you are there."
- Another stated that some transit systems are not safe and are dirty, and that any area mass transit system would need to be in good condition for them to use it.
- Another participant stated that they have noticed a trend in the Austin area toward building residential developments near commercial areas, such as the Domain, and that that should perhaps be a focus of regional planning.

- Another participant stated that such planning is fine for urban areas, but that new development in rural areas should be required to have a mass transit element included.
- One participant stated that “government mandates” scare them, and that they do not see things getting any better.
- Another participant inquired if there have ever been any commuting studies in the Jarrell area aimed at determining where in the Austin area residents are traveling to. This person also stated that keeping the left lane open to through traffic might help congestion, to which another participant stated that HOV lanes may be helpful to that end.
- There was general agreement among the group as to the benefit of HOV lanes, and no participants voiced any opposition to the concept.
- One participant stated that they recently traveled to Laredo on I-35 pulling a large trailer. At one point the road went down to two lanes and narrowed, and this participant suddenly felt unsafe pulling the trailer as it was taking up a good portion of the lane, which seemed dangerous.

The moderator at this point passed out an information sheet to the group regarding area trends.

- In response to the information one participant stated that there used to be no numbers attached to improvement.
- Another stated that urban sprawl takes away ranch land, which drives up land prices, and another stated that it also threatens “food security.”
- One participant stated that while they agree somewhat with restricting trucks from the left lane, that they in the past had worked with the American Automobile Association (AAA) on safety issues, and that in general “big blames small and small blames big.” This person estimated that 80 percent of traffic merging onto a highway goes immediately to the left and then exits a few miles on down the road. This person stated that they do like HOV lanes.

The moderator asked the group if anything on the information sheet surprised them.

- No participants indicated they were surprised by this information.
- One participant did note, however, that their area was not as bad compared to others.

The moderator pointed out that average daily traffic has increased, as has population, and inquired what should be done in the future.

- One participant stated that there needs to be increased law enforcement coverage between the Jarrell area and San Antonio.
  - A second participant agreed.
- Another stated that more cameras along the roadway might help, as they seem to be effective in Europe. The participant from Phoenix agreed that they helped in that region.

At this point the moderator noted that the group seemed to be focused on measures meant to address speeding, and inquired as to how there could be a problem with speeding in the I-35 corridor if congestion is such a big problem.

- One participant stated that drivers trying to “squeeze” through congested areas were a major problem.

The moderator next asked the group how they would like to see issues in their area, namely north of Round Rock, addressed.

- One participant stated that they regularly telecommute for their work and that the technology to facilitate this on a larger scale exists and should be better utilized.
- Another participant added that most are unaware of these types of opportunities, while another pointed out that Dell has transitioned to this type of work environment well.
- One participant stated that they had friends who worked for Dell that worked from home an average of three days out of the week. This participant went on to state that their spouse also works from home on occasion, but noted that it is only effective if you have the type of job that will allow for it.

The moderator next mentioned truck only lanes as one possible solution for the area and inquired as to the group’s opinions on this.

- To this suggestion one participant noted that even with this type of facility there would still be problems in Austin.
- Another stated that lanes could be added in the Jarrell area and that similar expansion has worked near Salado. This participant stated that they have noticed room for such expansion near area exits.
- Another participant stated that lanes should be expanded between Belton and Jarrell now while there is an on opportunity. However, this person still believed that Austin will be the biggest problem in the area.
- Another participant noted that there needs to be better coordination in planning for expansion, or else “choke points” will develop.
- A participant stated that rail should be considered as an alternative to long distance shipping of freight. This person also stated that building new lanes will only attract “new traffic.”
- Another participant stated that parallel routes should be developed for truck traffic, while another inquired whether a restriction on trucks traveling during the day (in other words, restricting them to driving at night) would work.
  - In response to that, a participant stated that that had been tried before and that it did not work.

In response to the ongoing discussion about alternative routes for trucks, the moderator inquired as to how such a system would work for smaller roads that go through small towns, such as Highway 95.

- To this question, one participant replied that trucks could just “go around” them.
- Another stated that they like the idea of developing alternate routes, but noted that it would require taking people’s land.
- Yet another participant stated that such facilities would be beneficial if main routes get shut down, such as what might occur in the event of a hazardous materials spill.
- One participant stated that this talk of alternate routes was basically about toll roads.
  - In response, one participant stated that the 130 toll road had not done “what it was supposed to.”
  - Another participant stated that a Spanish company gets all of the profits from the road.

The moderator asked the group for their opinions regarding “foreign ownership” of toll facilities.

- Eleven of the 12 participants stated that they disagree with such arrangements, and that they would likely use the 130 toll road if it was not owned by a foreign company.
- One participant (the participant from Phoenix) did not have a problem with toll roads or foreign involvement in them.
- One participant stated that the state’s major highways, I-35, I-10, and I-44, are “horrible,” and that they did not see why money should be spent on improving traffic flow when these facilities are “falling apart.”

The moderator asked the group to summarize their preferred options for addressing needs in the area. They were:

- rail,
- HOV lanes.
- better planning,
- telecommuting, and
- addressing truck issues.

The moderator next turned discussion to how transportation should be funded. The moderator first asked if anyone in the group knew how transportation was funded. None of the participants raised their hands in response. However, a few ventured guesses.

- One participant stated that the federal government pays for it, while another said that the federal government pays for some of it.
- Another stated that they would normally say transportation is funded by gas taxes, but that they were no longer sure of that.
- Another stated that property taxes fund transportation programs at the local level.

The moderator asked the group what a “federal” highway was.

- One participant responded that it was a road with “one of those federal signs”; one that resembles an interstate highway sign. This participant noted that the interstate highway

system was “sold” to the public on the basis of national defense, and observed that we are “past that now.”

The moderator next provided the group with some information on gas taxes and transportation funding in general. The moderator also introduced the concept of Texas being a “donor” state with regard to federal fuel taxes. The moderator noted that fuel consumption is expected to decline and, in response, one participant stated that fuel tax revenues would then decrease. The moderator also pointed out that the regional population will continue to grow.

- A participant responded that new residents should be charged a fee.
  - The participant who was originally from Phoenix noted that they had been charged a \$100 new Texas resident fee when they obtained their driver’s license.
- One participant inquired as to whether money could be saved by “streamlining” procedures among state agencies so that money “goes where it is intended.”
- Another stated that raising local fees, such as road and bridge funds, might be beneficial.

The moderator noted that there is a growing trend in counties stepping up to pay more for transportation development, due in large part to a lack of funding on TxDOT’s part. The moderator inquired as to whether some new form of revenue should be explored.

- In response, one participant stated that there needs to be better management of existing revenues. For example, people are paid to “count cars” when cameras can be used, and that in general there is government waste of this sort.

The moderator asked if the group agreed with this sentiment but there was no clear consensus.

- One participant stated that they were not sure, because they had a friend who worked in TxDOT’s bridge inspection program, and that in that person’s view there was not a lot of “slack” in their division’s operations. This participant did not rule out, however, waste occurring in other areas of TxDOT’s operations. For example, this participant believed that there was potential waste in TxDOT’s contracting practices and cited their personal experience with work that occurred in Round Rock in the past. This participant went on to state that the state’s needs could not be met by removing “pork” from the process and that new revenue would likely be needed.
  - There was one participant that agreed with this statement.

The moderator asked if there was consensus among the group that in the future “pork” should be trimmed from the transportation funding process and certain fees, such as driver’s license fees, should be increased.

- There was general agreement but no clear consensus.
- One participant asked how much revenue the gas tax brings in, to which the moderator replied that it was more than other revenue sources that fund transportation.

The moderator went on to ask whether the group would favor an increase in fuel taxes as opposed to more tolling.

- The majority of participants indicated that they would prefer this option, with one participant noting that the gas tax places the burden of maintaining the state’s roadway system on those who use the roads.
- One participant suggested a weight based tax as opposed to fuel taxes, as heavier vehicles place more of a burden on the highway system.

The moderator next asked the group about their opinions on a local option fuel tax, where revenues would be dedicated specifically to transportation.

- One participant noted that this would require an increase in property taxes, since less money would be going to transportation.
- Another participant observed that fuel taxes paid for most of the county courthouses in the state, which was not a good use of funds. Education, this participant stated, should operate better and the Robin Hood system should “go away.”
- This participant also stated that there are a lot of things the state could do, to which the moderator asked for examples. None were provided.
- One participant stated that the state should perhaps consider instituting an income tax, but there was little to no agreement from the rest of the group on this suggestion.
- Another participant stated that there should be “no new taxes” and that problems in the transportation sector are a “symptom of government doing too much.” This participant admitted that roadways are something that government should be providing, but that in general government spends too much on things it should not.

The moderator turned the discussion next to TxDOT specifically.

- One participant stated that people do not see any benefits, and that if there were benefits then government might be able to get more revenue.
- Another participant stated that TxDOT is currently outsourcing its maintenance operations, and another stated that the contracts are going to “foreign companies.”
- Another participant stated that outsourcing may not be the answer to the state’s transportation funding issues due to the fact that while there may be cost savings, there is a potential for reduction in quality and loss of control.
- This participant recommended “capping the allocation” of fuel tax revenues to education and increasing fuel taxes, with the revenues from the increase being dedicated directly to transportation.
- Another participant stated that the legislature takes too much money “for other uses.”

The moderator again brought up the notion of a local option tax and explained how it might work. The moderator also asked the group how they would feel about changing the fuel tax so it is assessed on the purchase price of fuel, like a sales tax.

- One participant stated that this would put fuel tax revenues on “a sliding scale with profiteers.”



- Another stated that this would result in a loss of regional planning coordination.

The moderator asked the group if its preferred option for future transportation funding is to raise the gas tax.

- All but two participants indicated yes.
- One of these participants indicated that they would support an increase in the fuel tax so long as the new revenues were dedicated to transportation.
  - Two other participants echoed this opinion.
- One participant added that the new revenues should be dedicated more specifically to road repair, and that no new revenue should go to “human resources”-type uses.
- Another participant stated that TxDOT should be held more accountable, citing the 1.7 million accounting error from 2009 as evidence of this. (No participants corrected this individual as to the correct amount of the accounting error.)

The moderator noted that the group seemed to support fuel taxes based on a “user-pays” premise, yet the group seemed very opposed to toll roads, which are even more user-based.

- One participant clarified that they supported toll roads.
- Several participants indicated that they would support the area’s system of toll roads but that the money is going to “foreign companies.”
- One participant inquired as to why education is getting such a large percentage of fuel tax revenues.
- Another pointed out that the state’s lottery was supposed to support education.
- Another participant asked if there was a figure for TxDOT’s “bureaucracy” cost.
- Another stated that there needed to be more control over increasing costs.

The moderator asked the group if anyone believed that anything will be done on I-35 within the next 20 years.

- One participant responded that while some things could be done, they are not likely to happen.
- Another stated that until the bottlenecks in Austin are remedied there will always be problems in the Jarrell area.
- One participant recommended an elevated roadway along I-35 all the way through Austin as one potential solution.
- One participant stated that everything in the area is “OK” for now.
- Another noted that “road age” and conditions were a problem.

- One participant stated that thinking ahead for 20 years requires “outside of the box” thinking and improvements to existing infrastructure. This person stated that addressing commuting issues and rail, as well as figuring out how to do more with less, would be key.
  - Another concurred that there is no one way to address future problems.
- Another participant stated that in the future there will be many more drivers, and that the question moving forward is how to reduce driving.
- One participant replied that people would use mass transit but it is not available.
  - The participant who made the statement regarding reducing overall driving responded that they would rather drive than take a bus.
  - Another participant countered that other areas have solved similar problems with the use of mass transit, such as Washington, D.C.
- A participant stated that the 130 toll facility is “worth it,” but that the profits are going to the wrong place.
  - In response to this comment regarding the 130 facility, one participant stated that they would really like to see more travel information with regard to I-35, as there are often times that they would use the 130 facility if they were aware of how bad traffic was on I-35.
- Another participant stated that the DC Metro is “great,” as they used to live there, and that they would use a similar transit facility if it was available in the area.
- Another participant stated that they travel a lot for their business, and they love the Bay Area Rapid Transit (BART) system in San Francisco.
- Another participant stated that they like the freedom that car travel affords them, and that they do not want to rely on transit. This person noted, however, that they do not have a daily commute. This person also stated that transit development leads to “massive growth at the end of the line.”
  - Another participant stated that Leander and Georgetown are already large.

The moderator closed the focus group meeting and provided participants with an opportunity to make a closing comment.

- One participant stated that they love driving the roads in the area. They stated that the two-way freeway access roads took some getting used to. This person stated that they liked living north of Austin but that older, more scenic rural roads are “going under” to accommodate growth. This participant likes things the way they are but noted that they are better off than where they came from. This participant also stated that people in the Central Texas area don’t know how to drive in bad weather.

- Another participant stated that safety is the most important thing to consider in the future. This person stated that “we all have to get on I-35,” and that residents should be able to reasonably expect that “we will not die.” This person stated that they had a new driver in the household but that they (the new driver) were not in a hurry to start driving. This is a trend that the participant has noticed is more and more common.

### **March 9, 2010, Austin, TX**

How do you use I-35?

- Use I-35 to get to work, but flex schedule long hours, state employee.
- Use I-35 by avoiding.
- Use I-35 for work to Capitol – state employee.
- Been here whole life, watched the city grow, use frontage roads mostly.
- Gotta get on I-35 by 3:00 or you will be in a traffic jam.
- Coming from Manor, mostly use 290.
- Use a part of 35 everywhere I go, I hate the bottom deck, won't go during back traffic hours.
- Minimal time on I-35, prefer one bathroom in the house to commuting on 35, will use only if it's the direct route, use it to go to Dallas, San Marcos, etc., it's crowded all the time.
- Avoid it if possible; do not need to use it for work.
- Two commute to work on I-35, some use alternate routes to 35, two commute but not using I-35 corridor.
- Driving on I-35 is not pleasant, but can be during non-crowded times.
- But you never know when there will be an accident.
- 40 years ago, you could easily travel on I-35.
- As population has grown it makes it more difficult.
- Traffic has changed dramatically in last 5-10 years.
- Jobs are here, so people are here.
- Downtown is a place with lots of jobs, new buildings.
- I-35 is the artery to get places.
- When the North American Free Trade Act (NAFTA) passed, heard that new lanes for the whole length would be needed.
- That would have been better than the toll roads, which just takes money.
- Toll roads are not convenient to me (lives central Austin).

For commuters on I-35, how many miles do you drive, and what is the length of time of your commute?

- For one participant, from Round Rock, 19 miles one way, takes 20 minutes between 6 and 6:30 AM; Evening, 6:30 is the same unless there's an accident.
- Another commutes 25 miles one way, and takes 30 minutes...depends on weather conditions, rubberneckers, and whether the University of Texas (UT) is in session (summer is better); in evening, 35 minutes if leave at 4:30; could take 45-hour at 5:00.

Do you notice the difference when UT is in session?

- Equate it more with school being in session, holiday, and summer.

Do you carpool? The bus?

- The bus “will take 2-3 days,” and it’s not any quicker because sitting in the same traffic.

What if there was a lane for the bus?

- Depends on number of stops the bus makes. From central Austin, the bus is more pleasant.
- Where would an HOV lane go? There’s no room left. In Dallas, there’s a ribbon barrier that uses a lane. But other than that, TxDOT would have to get more ROW or elevate, and that would be costly and an environmental issue. Don’t know about other solutions. Metrorail is a good start, but there may be safety issues. Other cities elevate their trains. I would use a train if it was more convenient and cheaper.
- I think an HOV lane would help. The ones in Houston need more than one person.
- I use the HOV lane driving to Dallas, but it isn’t on the older roads and can’t get through Dallas since there’s no place to put it.
- Would have to go underground, which isn’t going to happen.
- The Dallas ribbon barrier takes a lane.
- People don’t want to give up their car to share a ride or get on the bus; there should be some incentives to give up your vehicle and get on the bus. The bus schedule isn’t convenient. We need some creative methods to get people out of their cars. Going to alternate work schedules and working from home is being allowed in my work place. I would ride with other folks if there was a means to get home in emergency.
- Vanpool options in Utah.
- Give everyone a smart car.

What is the biggest problem with I-35?

- Too congested.
- Not enough alternate relief routes if there’s an accident.
- Not enough space to expand.

What about trucks?

- At the Bell County lane, when the trucks actually stay out of the left lane, it helps. Someone driving a u-haul didn’t think it applied to them.
- If we could re-route the trucks then it would create some space; mandate that trucks get off of I-35.
- Are trucks using the bypass?
- I don’t think the trucks are using because of the cost.
- I would go on the bypass if I was driving from San Antonio to Dallas, because it would be faster and more pleasant.
- Are the trucks really that big a problem? I don’t think they are as big a problem as the sheer number of cars.
- One participant thought trucks should have their own lanes.

The moderator distributed the handout, and asked if anything was surprising?

- Percentage of trucks looks small, but it is a large number of cars.

- Higher truck numbers both north and south of Austin.
- But the percentage is of a (?)
- “What are we going to do about this?”

Is this believable?

- Yes.
- It seems overwhelming.
- “Where are we going to put 300,000 people and all their cars?”
- Truck traffic will increase and have a greater impact on conditions, and greater importance to divert.

How are we going to solve this problem?

- We need more alternate routes; concentric relief routes in other cities, why don't we have more? You need to acquire homes before the homes are there; the toll road is a good start. Some may think it's cost prohibitive but it's helping.
- I don't believe the toll road is helping. It's still bad after it was built, so who did it benefit?
- I think the toll road is supporting a lot of the growth, and relieving traffic, not the current routes but the ones coming in.
- I-35 is serving the employment in Austin. If you build more businesses outside of I-35 that would help.
- But if you disperse the employment locations then you reduce the options for transit.
- Trains, buses, carpools – massive campaigns, we have to have discussions to convince folks this is an alternative to free up I-35; it used to be okay in the past, but because of all of the businesses, there is a greater reliance on I-35 to get to work or school. I-35 is not going to continue to support. Must look at creative solutions through education to get people out of their cars. Trucks: they are the equivalent of 4 cars in length, so get the trucks on alternative routes. They won't like it because of the high taxes they pay. Have you ever seen a tractor trailer on the toll road?
- I think trucks will use the toll roads once they get more used to them. The toll roads were built for the future; I-35 has surpassed its life.
- East-west arterial in Austin has been talked about a long time.

Can you do anything to I-35 now?

- Dallas did North Central expressway and depressed it.
- The inconvenience of the construction.

Is the consensus that you cannot expand?

- Yes.
- Can build on top. Go up.
- It would be costly.
- Toll road was a bad use of money.
- If the toll road was cheaper it would be used more.
- Still have to get downtown.
- The toll road isn't going to solve this problem to get into town.

- Getting people into central Austin.
- Like the idea of reducing tolls to get traffic off of I-35.
- Use signs to display travel time to show that it's an alternative.
- Move businesses to the toll road.

#### Operational strategies?

- Radio updates every 5 minutes to say where accidents are.
- GPS is used to identify accidents and give alternate routes (my daughter's boyfriend uses it).
- Use the toll road to get to the airport, more miles, takes a few minutes longer, is reliable, no congestion. But there's a cost factor.
- Use toll as credit for bus/or train (using the toll road to get to the station).
- Use signs to display travel time to show that it's an alternative.

#### What is a sincere campaign?

- Tell people the benefits of the toll road; studies, video, and examples.
- Identify where people live and work, then devise a personalized travel approach (targeted outreach to people); events, day of the week, time of the day should be considered.
- No one reads the newspaper anymore.
- More education is needed.
- I don't know where the toll road goes or where to take it.
- Encourage affordable high-density housing centrally located to make it more affordable to live in town so people aren't forced to commute.

If TxDOT were to educate you on the toll road would you see it as them trying to push you onto the toll road?

- Still doesn't solve the Slaughter to 12<sup>th</sup> street problem.

#### Rail?

- It's been controversial, and expensive.
- The current system will take cars off 183, not I-35.
- There's been discussion of rail from Georgetown, but it's very costly.
- To Dallas? I would want a car once I got there. I would still have to get around if I got there. And I would be going to Lewisville, so that doesn't help.
- I've lived in other cities where it was convenient and a car wasn't needed. I took the train to Ft. Worth and it took 6 hours. But a convenient train makes sense.
- Moving freight by rail is a good idea, but in Chicago it takes 2-3 days to get freight across the city because no one wants the rail placed in their backyard.
- Good for moving freight by rail from the border to Oklahoma, it becomes more cost effective.
- I don't think trucks are the biggest problem; get a grip on the regular traffic.
- If tolls were cheaper for trucks, then more would take 130.

#### How to pay?

- The toll road provides an option, and you can pay for what you use.
- You can pay for use or pay through gas taxes.

- The people moving here should pay a fee.
- Impact fees from new development.
- London – fee to get into the central city.
- I don't like that idea.
- Even if there are alternates, there's no assurance that people will get off I-35; 130 case in point.
- I take the toll road in Houston, because 1. It's cheaper, and 2. It is convenient; the toll road here doesn't get you there.
- A lot of employees that are downtown are state employees, why don't they mandate a move from downtown or force people to commute differently.
- The state moves to new offices on I-35.
- Poor planning.
- The big problem, according to the data, there's prosperity, jobs, and tremendous growth, and people are going to drive their nice cars by themselves and won't get out of them; so need alternative routes (which they won't use), and do an incentive program:
  - People can carpool, and pay them \$100 per month to not drive your vehicle.
  - Get the State of Texas on board.
  - Vanpooling.
  - Staggered work hours, flexibility.
  - Building new roads and rail is fine, but we need to do the easy fix now.
- Need shuttle service – smaller bus or vans that are more convenient.
- Ban people from coming to Austin.
- Offer incentives for people to move outside I-35 corridor.
- A toll road that gets people downtown.
- Pay for fixes through taxes.
- Raise the gas price because people will change.
- That's how conservation works.
- There will be opposition – no one wants the roads, no one wants them in their backyards, no one wants to pay.
- We have to change the mindset.
- Education, people don't know what it costs.
- I-35 through downtown – add lanes to the elevated section.
- Convert a general-purpose lane to HOV lane during peak periods.
- Difficult to put a toll on an existing road.
- Combination of tolls and taxes.
- Sin taxes.
- Austin has the money and can do it if they want to, but they would rather pay for jails.
- Charge a tax for rental cars, hotel taxes.
- Commuter taxes have been used in other places.
- Can't raise property tax; that isn't right.
- Payroll taxes for businesses, businesses outside would pay lower rate.
- Relocate state employees to one complex; property is worth more.
- Housing downtown.
- Raise registration fees.

What is your solution and how would you pay?

- Expand I-35 with money we have.
- Move businesses away from I-35.
- Move state offices.
- Incentives of all kinds, businesses, get people out of cars; payroll taxes with sliding scale.
- Fuel tax increase and tolls.
- Fuel tax is a minor expense now.
- Convert general-purpose (GP) lane to HOV lane, offer incentive with campaign for getting out of car, alternate work schedules.
- Downtown state and county agency issues, getting employees to and from work, provide bus/shuttle services for employees.
- Build government offices outside downtown.
- Expand upward on I-35, building other highways, paid with fuel taxes.
- Encourage future growth out of I-35 corridor for 2035 projections.
- Give incentive to businesses to move out; not fuel taxes but luxury taxes (alcohol, cigarette).
- Toll road express to downtown.
- Encourage trucks and other vehicles to take the toll road.

#### **April 6, 2010, Laredo, TX**

How do you use I-35?

Participant 2 – I have a son in Denton and things get very hectic during the holidays. I would like to have a “super duper” highway that goes around or over cities that you are not going to be stopping in. I have used 281 in the past and it is OK, but it is almost a nine hour drive. So I would like a “super highway” but it does not have to be parallel or even within the I-35 right of way. Austin is especially bad and I have to time my trips and leave at around 3 AM in order to avoid Austin and San Antonio traffic. I would think about taking the 130 toll road if it also bypassed San Antonio.

Participant 6 – Each town along the corridor should look for solutions and find ways of getting local traffic off of I-35 so that through traffic can use the facility.

Participant 4 – I was on the board of the Texas Economic Development (commission?) and had to attend meetings in Austin. We would meet at around 9 AM and I would stay the night before and sometimes even skip meetings so as to avoid San Antonio congestion. My daughter from Plano takes 281 to avoid congestion. The corridor between San Antonio and Austin is “super congested” and it seems like the construction never ends.

Participant 2 – I go to Fort Worth and there always seems to be construction.

Participant 5 – Local traffic is fine here except for around Loop 20.



Participant 2 – I heard that there were many problems and scandals that cause construction of the loop to take forever. People are afraid to use it because of the tractor trailers.

Participant 5 – It is supposed to be for commercial vehicles only.

Participant 4 – I have a ranch around Encinala. I never have any problems until I reach San Antonio.

Participant 2 – I would like better and more rest areas. Trucks are taking over what is there. The rest stop that is on 281 between Freer and the Valley is nice.

Participant 3 – I take I-35 everyday and there are no signs in Spanish. There are a lot of people making money off of the locals and Spanish speakers but a lot of people can't even understand the yield signs. It is very dangerous.

Participant 8 – People around here need to learn English.

Participant 3 – Things are bad... “Horrible” at Del Mar near the Golden Corral.

Participant 2 – Yes. It is bad there at that location. I drive there every day.

Participant 3 – There are accidents all the time. In Mexico there is no real test for you to get a driver's license.

Participant 4 – At exits on 35 where side streets converge there should be a yellow line before hand, because people are trying to beat exiting vehicles to get to the light. I agree about the need for Spanish signs. We make money off of these people.

Participant 6 – People get impatient and try to get on the freeway. TxDOT seems to be trying to develop alternatives to I-35, which is good.

Participant 4 – Halfway down between Del Mar and Mann road is bad.

Participant 7 – Segment Four needs a “facelift.” It is horrible. It is never smooth and the lanes are uneven. We are far behind compared to other segments. Toll roads are one option and I understand that there is a funding issue but nothing has been satisfactory.

Moderator – Why do you think things are so bad?

Participant 7 – Del Mar and Mann are the worst. I don't know why it is permitted for that area to be like that.

Participant 1 – It is very dangerous.

Participant 2 – I always have to hurry over to make it to the exit on that stretch.

Participant 1 – As far as us being behind, TxDOT allocates based on population. That is why it all goes to Dallas and Fort Worth and Houston. However, we have a large population and it is going to get bigger.

Participant 4 – Our customs agency collects more in duties than any other state. Why is it that there are barriers being built in the median between here and San Antonio? How many deaths have occurred to warrant that?

Participant 3 – When accidents occur there is not much warning to other cars down the road. If the accident is not cleared in time then there are often other accidents that occur because of it.

Participant 2 – There was a bad accident a while back and people were going in reverse on the highway to go around. There was no law enforcement presence.

Participant 3 – The police often direct traffic at the scene of the accident but do nothing along the approach to the accident.

Participant 6 – What about passenger rail for people traveling to San Antonio.

Moderator – Would this be a good idea? Would you use passenger rail?

Participant 6 – Yes.

Participant 9 – I would take it to avoid trucks. Also, the lighting on I-35 is bad. It's too dark at night.

Moderator – Is truck traffic a problem?

Participant 9 – Yes. I try to avoid trucks whenever I can.

Participant 8 – I agree.

Participant 9 – A separate lane for trucks would be good.

Participant 2 – I like the lane restrictions they have around Austin.

Participant 4 – Trucks here stick to the right lane. It shouldn't be a problem here.

Moderator – Would enough people here use rail?

Participant 6 – Yes.

Participant 9 – No. The mentality here is just not open enough.

Participant 2 – But it would be good for tourists.

Participant 5 – We already have rail. There is a shuttle to San Antonio and then you can take Amtrak to Chicago and beyond. People will have to take public transportation once they get there, though.

Participant 1 – It's a cultural thing here in Texas. Light rail didn't happen in Austin so it definitely won't happen here in South Texas.

Participant 2 – But it might be good for “winter Texans” and students.

Moderator – What about moving freight by rail?

Participant 2 – We already do that. There are a lot of trains running in the area and they cause problems with commuting. They actually cause more problems than they address. I would like to see some sort of technology that tells me where the trains are going so I can plan my trips around them.

Participant 1 – Ninety percent of our freight goes by truck. The remaining 10 percent is by train in the Laredo area.

(Moderator passes out handout.)

Moderator – Is there anything on here that surprises you?

Participant 2 – I am surprised that there is not more red on here.

Participant 3 – I am surprised by the population projections.

Participant 1 – This is good information. We should be “250-ish.” The map is surprising in that there are no other cities between San Antonio and Laredo so there should not be all of these “different colors” between San Antonio and Laredo. There are no other traffic factors in the area as those two cities are the biggest trip generators.

(There is general confusion in the group on the topic of level of service and the associated map. It does not appear that the maps give enough information to the participants so that they know what the map is trying to convey. Moderator explains...)

Moderator – So regardless of the maps...things are getting worse in the area. What should be done?

Participant 2 – Extra lanes would be good. Lane restrictions would also be good.

Participant 7 – Reroute trucks between Laredo and San Antonio. There are too many accidents.

Participant 1 – TxDOT does not appear to take into account truck traffic in allocating money to the area. Trucks do much more damage to the roadway.

Moderator – Do you think that trucks are paying their fair share?

Participant 1 – Well, TxDOT is not allocating based on wear and tear.

Participant 10 – A toll road for trucks might be good.

Participant 3 – They pay in Mexico.

Participant 4 – But then it would be passed on to the consumer.

Participant 3 – We paid \$40 to use a good road in Monterrey.

Participant 1 – Roads are built to last longer in Mexico. They use concrete.

Moderator – Solution is toll road for trucks?

Participant 4 – Do we want to be the “Guinea pigs” on this type of thing?

Participant 5 – We “lost our shirt” on the Camino Columbia.

Participant 2 – Build road for trucks and if they mess it up make them pay for it. I’d also like to see more emergency phones.

Moderator – So how should we pay for these changes? How is transportation currently funded?

Participants 2 and 5 – The lottery.

Participant 1 – Gas tax and the feds “kick in” some money, too.

Moderator – How much is the gas tax?

Participant 2 – “A lot.” It is a percentage of the purchase price. (Participants 6, 8 and 9 agree.)

Participant 1 – It is 20 to 30 cents.

Participant 10 – 10 cents?

(Moderator discusses tax...)

Participant 5 – So it is a fixed amount regardless of price?

Moderator – How much does it cost you per year?

No answers/guesses.

Moderator – It costs about \$250/year. Is that a lot?

Participant 3 – As much as I use the roadway and as bad as the roadway is I think it is a lot. Going back to planning issues...I-35 is really bad around Target. It goes from three lanes to two.

Participant 6 – They keep adding traffic lights, which causes problems in the area and puts more people on I-35.

Participant 1 – TxDOT should forget about amount making Loop 20 a loop. Just put lights on it and build a brand new loop.

Moderator – But how do you pay for that?

No answers.

(Moderator describes pay-as-you-go financing...that is why Loop 20 is taking so long...)

Participant 1 – Offer pass through tolls and increase vehicle registration fees. Realistically we should offer tolls as an option. We all feel that we get taxed too much.

Participant 4 – Why don't trucks count for more in the money we get?

(Moderator discusses funding...donor/donee states...)

Participant 1 – How do individual roads and bridges get selected for funding?

Participant 3 – Loop 20 was built to serve the university and a few other places, but developers moved in and now there is a lot more traffic.

Participant 2 – I have been here for 24 years and the changes I have seen are remarkable.

Moderator – So what do you do about these changes?

Participant 1 – TxDOT should look at cost savings. For example, putting the little bricks and fancy decorations on overpasses seems like a waste and is not needed. Need to look at cost cutting.

Participant 6 – Should legalize slot machines.

Moderator – How long has it been since the gas tax was raised?

No answers.

Moderator – Not since 1991 at the state level. Are you surprised?

Participant 5 – Not really. So I guess we are due for a raise.

Participant 1 – There are more vehicles today and they drive farther, so there should be more money. But I guess fuel efficiency is something that needs to be considered too.

Moderator – So would you rather see fuel taxes raised or more toll roads? (A lots of no answers...)

Tolls – 6 in favor

Many said support for a fuel tax increase would depend on where the money was spent.

Participant 4 – Why build toll roads over free roads?

Participant 5 – What are the advantages of a toll road? Is it just quicker drive times?

Moderator – Most money today is spent on maintenance. What about the idea of a local option fee?

Participant 2 – So people who use the roads pay for them.

Participant 4 – So upping the gas tax will put more money into the state fund, but it still won't come here.

Moderator – So does anyone have a problem with 25 percent of state revenues going to education?

Participant 10 – Why not get money for education from other places?

Participant 2 – The lottery is supposed to help education, right? As well as local taxes?

Moderator – So how should transportation be funded?

Participant 1 – We can't depend solely on toll roads but they need to be an option. People should be given the option and allowed to make the decision on their own.

Participant 4 – I am against toll roads. Period.

Participant 2 – I liked the toll roads I used at Syracuse where my daughter goes to school.

Moderator – So we have a general consensus on local option? (General — Yes. Three participants said no.)

Participant 1 – People would likely not notice a gas tax increase, but it is also the perception of a new tax. Laredo should be allowed to capture some of these revenues. So yes, I favor the local option.

Participant 2 – But this is just gas taxes. Maquilladora site locators complained about local taxes so we need to keep the focus on gas taxes.

Participant 1 – It should be kept local and not go statewide. Funds should not be distributed the same way they are now.

Participant 4 – I don't want to share with the rest of the state. I am adamant about rewarding our school teachers so that we can have a better education for our kids. We need to attract better teachers.

Closing Remarks

Participant 10 – It would be nice to have lower gas prices.

Participant 2 – We should charge developers more for transportation purposes. Can that be done?

Participant 1 – Sometimes developers are required to come to the table with money.

**April 14, 2010, Dallas, TX**

Participant 6 – “I go up and down I-35 E a lot, mainly between Denton and Waxahachie and often into Rhome. The time of day has a lot to do with how bad congestion is but often it does not matter what time it is. Wherever there is construction it seems that there is always congestion.”

Participant 2 – “In Fort Worth there is always a bottleneck just north of downtown. I have a lot of customers who come in from out of town and I have to give them directions to get around. I have asked about having a sign put in at Exit 51 where there is no information. It is often very congested south of Lewisville near Sandy Lake.”

Participant 1 – “I come from I-35 south of DeSoto and Cedar Hill. It is two lanes in that area and is very congested during the ‘work time.’ It also gets very bad in the Lewisville area and Regal Road and 635. People drive crazy!”

Participant 2 – “Is that because it is 4 to 5 lanes wide and then narrows past 635 to 2 lanes?”

Participant 6 – “And only one lane to make the exit.”

Participant 1 – “Yes, and coming onto I-35 north it gets bad, too.”

Participant 3 – “I’ve been on 30 and 635 but I don’t travel on I-35 that much.”

Participant 1 – “I’ve taken I-35 through downtown in both the north and south directions and there are always accidents.”

Participant 4 – “My office is at I-35 and Walnut and the split at 112 is bad.”

Participant 1 – “I don’t travel on I-35 all that much because of the accidents.”

Moderator – “Do you use alternate routes?”

All – “Yes.”

Moderator – “What routes do you use?”

Participant 1 – “It depends on the deliveries as my windows are small. GPS helps but I’ve been driving for 20 years and everyone knows the alternate routes. You really need to have a third choice in mind.”

Moderator – “Does anyone carpool?”

Participant 3 – “I used the buses when I first moved here but they were always late.”

Participant 1 – “I rode the bus in the Oak Club area and it was on time. I don’t recall it using the HOV lane, though.”

Moderator – “What is the biggest problem on I-35?”

Participant 5 – “I came from Lancaster (Pleasant Run to downtown) and the quality of the road is not good. It is a problem.”

Participant 6 – “The changing number of lanes causes problems.”

Participant 1 – “I think it should be widened to accommodate all of the people moving into the DeSoto area.”

Moderator – “Do you think that there is room to widen the facility?”

Participant 5 – “They can make room.”

Participant 6 – “At Lake Lewisville it goes from being 5 to 6 lanes down to 2. It causes congestion in both directions.”

Participant 1 – “The “Mixmaster” is bad during work hours.”

Moderator – “So is congestion the biggest problem?”

General response – “Yes.”

Participant 6 – “All of the exits and the associated weaving of vehicles cause a problem.”

Participant 5 – “Pleasant Run to downtown is old and doesn’t seem to have been touched. The new Central Expressway is “amazing.” That should be done to I-35.”

Participant 4 – “I take Walnut to Central and then go downtown.”

Moderator – “Do you experience congestion during other times of the day?”

Participant 6 – “Yes.”

Participant 1 – “At 9:00 and 10:00 it is fairly reliable. However, the problem is during the peak.”

Participants 2 and 6 agreed.

Participant 4 – “I use the facility at night. It is reliable then.”

Participant 1 – “I used I-35 E when I moved here. It was my ‘marker.’ If I could find I-35 E I could find where I needed to go in the city.”

Moderator – “Are trucks an issue?”

Participant 6 – “They are a problem everywhere.”

Participant 5 – “They are a problem on I-35 especially. You can’t get around them.”

Participant 1 – “I don’t recall seeing a lot of trucks on I-35. On interstate 20, yes, but not on 35.”



Participant 5 – “They just don’t use 35.”

Participant 2 – “Is there a law banning them from using the inside lane?”

Participant 5 – “I’m still confused by what the speed limits are on I-35.”

Participant 4 – “There aren’t any, really.”

Participant 6 – “I don’t see any truck restriction signs.”

Participant 4 – “The inside lane is supposed to be for passing, anyway. “

Participant 5 – “I would like to see more reflectors on I-35. It is hard to see the roadway sometimes, especially at night.”

Participant 2 – “When there is construction and cars are not using the usual white lane separation lines it can be bad. It ‘scared me to death’ going through Arlington the other day. They need to do a better job of marking lanes during construction.”

Participant 6 – “They also need to black out the old lane separation lines.”

Participant 1 – “Off of Harry Hines you can get on I-35 going southbound but you can’t get on going northbound.”

Participant 3 – “It has been like that for years.”

Participant 5 – “If I can use the tollway or other roadway besides I-35 I will.”

Participant 1 – “Agree.”

(Moderator passes out handout.)

Participant 5 – “I often take old highway 77 to Waxahachie instead of I-35. It is often just as quick.”

Moderator – “Is there anything in here that surprises you? What about the population projections.”

Participant 2 – “No, these don’t surprise me.”

Participant 4 – “We are right in the middle of the country.”

Participant 1 – “Seems high to me.”

Participant 6 – “But these projections are for 25 years or more.”

Participant 1 – “Isn’t Frisco growing really fast?”

Participant 5 – “All of the ‘peripheral’ cities are growing very quickly.”

(Moderator discusses increases in daily traffic.)

Participant 1 – “Wow!”

Participant 2 – “This doesn’t surprise me.”

Participant 5 – “Look at the 4 percent trucks leaving downtown...I-35 by the Hyatt Regency (Woodall Rogers) is no place for trucks.”

Participant 6 – “It is probably because they are taking I-35 West instead of heading into Dallas. “

Participant 1 – “They probably also know how bad congestion is on I-35. Does 75 go into Oklahoma?”

Participants 4 and 6 – “Both.”

Participant 2 – “People are moving into Texas because of the tax climate.”

Moderator – “So you would say the area is still going strong?”

Participant 6 – “This area has weathered the tough times. I traveled a lot in the ’80s.”

Participant 1 – “I thought the 74 percent seems off but I guess not.” (Not sure what the 74 percent refers to...)

Participant 5 – “There have been times that I have taken the DART rail downtown...”

Moderator – “But you said you don’t use the bus.”

Participant 4 – “Well yea, the rail is better.”

Moderator – “Does anyone here commute by rail?”

Participants 4, 2, and 6 – “No.”

(Moderator discusses level of service.)

Participant 5 – “I agree with the breakdown portrayed here, but this is if nothing happens, right?”

Moderator – “No.” (Explains...)

Participant 5 – “Things would be worse off without the rail from Westmoreland.”

Moderator – “Is the rail helpful?”

General “Yes.”

Moderator – “And some people use it to commute (but not you)?”

General “Yes.”

Participant 4 – “The park and rides help a lot with the commuters.”

Participant 6 – “Extending to Flower Mound may not help LOS but it could help other things.”

Moderator – “So does everyone generally agree with the projections shown here?”

General “Yes.”

Moderator – “So what should be done?”

Participant 2 – “Double-decker.”

Participant 1 – “Don’t we have one of those on at 75?”

Participants 4, 2, and 6 – “No.”

(Participant 2 explains what a double-decker is to Participant 1.)

Participant 1 – “Ohhh...I like that!”

Participant 2 – “But how far do you have to go? 75 seems perfect for a double-decker.”

Participant 4 – “It could help traffic on I-35.”

Moderator – “So add lanes going north and south through downtown?”

“Yes.”

Moderator – “What about the double-decker concept? Is adding lanes to I-35 the answer?”

Participant 6 – “It would be an improvement but not the answer. The number of lanes needs to be consistent...of course cost and time will be an issue.”

Participant 1 – “Yeah, construction can cause congestion.”

Moderator – “What about right of way for the expansion?”

Participant 5 – “The segments running through downtown will need that the worst.”

Moderator – “So when you are going into Oklahoma, do you have to take I-35 and go through downtown? Would parallel facilities work?”

Participant 6 – “We already have Loop 635.”

Participant 4 – “We actually have three loops.”

Participants 4 and 6 – “But they don’t save time.”

Participant 3 – “I like the double-decker idea.”

Participant 5 – “We have the lottery.”

Participant 6 – “Yeah, and we should legalize gambling.”

Participant 1 – “The question with regard to a double-decker is: what are we double-decking for?”

Participant 2 – “I think we should double-deck for through traffic.”

Participant 5 – “Like traffic heading from south Dallas and through downtown.”

Participant 6 – “Yes, only you have to be able to get on and off at the major highway intersections.”

Participant 4 – “Or just make the exits onto 635 easier. That area causes a lot of congestion.”

Participant 5 – “The bridge over the Trinity River needs widening.”

Moderator – “What about your travel on Segment Two?”

Participant 2 – “I-35 past Hillsborough is OK. There are fewer cars there.”

Moderator – “Is there a loop in Fort Worth for I-35 W and, if so, is it as bad as 635?”

Participant 6 – “Pretty much.”

Participant 1 – “820 is busy.”

Participant 6 – “Sometimes the west side of Fort Worth is alright, but traffic on the north side of the city is some of the ‘worst in the state.’”

Participant 2 – “It goes down to two lanes and narrows, which causes a lot of congestion.”

Moderator – “So do you all think that the double-decker is the best idea?”

General “Yes.”

Moderator – “But will the people living along I-35 like the idea?”

Participant 6 – “Who lives along I-35? It seems like it is mostly commercial property.”

Participant 1 – “Adding lanes would be more cost effective.”

Moderator – “What about a rail line to Austin?”

Participants 2 and 4 – “That would be nice.”

Moderator – “And what would you do once you arrived at your location?”

Participant 4 – “Take a cab.”

Participant 5 – “I think there need to be more lanes running in the Trinity River bed.”

Moderator – “How should all of these improvements be paid for?”

Participant 6 – “Legalize gambling.”

Moderator – “How is the transportation currently funded?”

Participant 4 – “Sales taxes?”

Participant 5 – “Lottery.”

(Moderator discusses transportation financing.)

Participant 6 – “I still say we should legalize gambling.”

(Moderator discusses the effect of fuel efficiency on fuel tax revenues.)

Participant 5 – “So electric vehicles are not a good idea.”

Moderator – “What about making a double-decker that is an express toll facility?”

Participant 6 – “Seems to work on 75.”

Participant 2 – “I like the idea.”

Participant 5 – “It’s a good idea...better than taxing the city.”

Participant 2 – “I like tolls.”

Participant 6 – “I like tolls and gambling. People just don’t want to hear about more taxes.”

Moderator – “What about these diversions to education?”

Participant 4 – “Yeah, we need to get that back. Property taxes are supposed to pay for education.”

Participant 5 – “But we can’t take it back. Besides, a couple of cents on fuel is not that bad.”

Moderator – “What about a fuel tax increase where the new funds would be dedicated to transportation?”

Participants 1, 2, and 5 – (Unsure....thinking it over.)

Participant 5 – “As long as the money goes to transportation that would be alright.”

Participant 6 – “And no money to salaries, and more studies, focus groups, etc...”

Participant 5 – “Well do we all agree that you can’t put tolls on existing roads?”

Participant 4 – “121 was a joke.”

Participant 6 – “But it is better now.”

Participant 4 – “Well, yeah...”

Moderator – “What about adding a new lane on I-35?”

General agreement

Moderator – “And what about using congestion pricing on that lane?”

Participant 5 – “I don’t understand.”

(Moderator explains congestion pricing...)

Participant 1 – “That’s not fair.”

Participant 5 – “I don’t like that. It should cost less if it is more crowded.”

Moderator – “But you are guaranteeing a 55 mph speed limit.”

Participant 2 – “But what about breakdowns?”

Participant 4 – “In Houston they give you 30 minutes to move your vehicle.”

Participant 1 – “What if people don’t have money on hand? You would have to write tickets.”

Moderator – “It would be all electronic.”

Participant 4 – “TxTag makes that all easier.”

Moderator – “So a double-decker from downtown outward that is toll financed...”

Participant 2 – “Tolls and taxes add up and are costly. People need to have a choice.”

Participant 1 – “I don’t think the price should change. It should be flat.”

Participant 2 – “I agree.”

Participants 5 and 6 – “I like the toll roads.”

Participant 6 – “The toll roads in town are some of the better ‘traffic flow situations.’”

Participant 2 – “The signage on the double-deck facility in Austin is terrible. Need to do better if done here.”

Participant 4 – “What about having more HOV facilities?”

Moderator – “Is there room?”

Participant 4 – “Don’t know if it would help.”

Participant 2 – “It would help but not enough?”

Participant 5 – “HOV lanes are a waste.”

Participant 6 – “Yeah, it didn’t drive enough SOV to adopt HOV. There is ‘too much individualism.’”

Participant 1 – “Why is it so busy at 9 and 10? People should be at work?”

Participant 6 – “It’s all service people like me.”

### **April 21, 2010, Fort Worth, TX**

Moderator – “So, why don’t we start with you all telling me about your travel on I-35.”

Participant 1 – “I have been using 35 since I could drive so that’s like; well I am 34 now so. I have always liked 35. In Austin, I have used it all over the place. Are you just talking about this area?”

Moderator – “Yes, we are primarily just talking about this area. I should have mentioned before I got in here that we are looking at the entire length of 35 but we are focusing primarily on Segment One. That is from here to just south of DFW. The segments overlap a little.”

Participant 2 – “Have you tried to get through there between 4 and 5 o’clock in the afternoon. There are not enough lanes.”

Moderator – “Okay, not enough lanes.”

Participant 2 – “Yeah there are too many people at that time and there is a lot of construction going on.”

Moderator – “Now let me ask you all, since we are talking about 35, to make distinctions since we are over here in Fort Worth. Please tell us if you are talking about W or E.”

Group all understands and says okay.

Moderator – “Do you think traffic congestion is bad during the peak hour?”

Participant 2 – “Yeah is 35 E going this way and west is that way? Yeah East is really congested between 4 and 5 o’clock. It is at standstill.”

Participant 3 – “Yeah and I think that when I first came to Fort Worth about 10 years ago, you didn’t have to sit in traffic and now you have to sit in traffic. Like on 35 going to Denton, is that west? Now with alliance and everything, between there and the 820 split, it is just horrible. At 3 o’clock today it was backed up.”

Moderator – “So what you are saying is that it has gotten worse over the last 10 years?”

Participant 3 – “Yeah because it used to, that is what I loved about this side is that you didn’t have the traffic, but now we are becoming like Dallas because it is so backed up on the roads.”

Participant 2 – “Is there any thought about making the travel to Alliance any shorter? From here or from a distance it is a long drive on that straightaway.”

Moderator – “Now when you say making it shorter, what do you mean?”

Participant 2 – “Like making a bridge. Or, a service road that goes down and makes things quicker, even though. You have never traveled there have you?”

Moderator – “No.”

Participant 2 – “I can’t explain it then. But Alliance to here is a long way.”

Moderator – “And that is the airport you are talking about right?”

Participant 2 – “Yes. Down over in the commerce area where all the warehouses are.”

Participant 3 – “Yeah they built a whole big new development over by Ross Perot Jr.”

Participant 2 – “There are a lot of businesses over there.”

Participant 3 – “Yeah there are a lot of businesses over there just coming out that way that have moved out that way. There is a lot of house building going on that way too. A lot of subdivisions are being built.”

Moderator – “So, what does that tell you?”

Participant 4 – “We are thinking about it.”

Everyone nods yes.

Moderator – “Traffic is going to get worse.”

Participant 4 – “I realize that I have two uses for 35E which is mostly where I drive. One is daily use, getting around town which is often at peak times.”

Moderator – “Now, wait a minute – now I am confused. You are traveling around town on 35E?”

Participant 4 – “Yeah on 35E.”



Moderator – “So you are traveling around Dallas then, not Fort Worth?”

Participant 4 – “Yeah I live in Dallas.”

Moderator – “Oh sorry, I thought you said you lived in Fort Worth.”

Participant 4 – “No, but you asked to distinguish which one we were talking about.”

Moderator – “No that is fine I just wanted to make sure.”

Participant 4 – “I have two uses – one as an around town artery taking me to the courthouse or to the library or around for those distances that I would not want to cover on surface streets. The other is a portal to get out of town, like heading up to Denton or Gainesville. I don’t run across the bridge in Gainesville as much as I used to, now that they sell beer here. But, that was the getaway going up to down south on the way to Waco and Austin. So, I am really realizing that I have two uses for 35E as day to day freeway and as a portal to other places.”

Moderator – “And how is your experience?”

Participant 4 – “It’s as crowded as most as a day to day freeway. It is becoming more and more unpleasant to travel as a portal, especially between here and Austin. We have a place in Wimberley and it is worth taking the back roads. It is not worth the fight, especially around holiday time.”

Participant 2 and Participant 3 both agree.

Participant 5 – “I believe my opinion might be skewed because I come from Los Angeles where traffic is already jammed. You don’t think about it, you just do it. I remember 35 E in 97 and 98, because I always thought it flowed better until you got to downtown. It might come to a stop but I never remember it being slow until you got past downtown. All I could use coming in to downtown to the west side of Fort Worth, it is only those 2-3 lanes. When you are coming toward Belknap — do you know where I am talking about? It gets real small. When you come past Lancaster it gets backed up. Now that is west. Coming from Dallas, in Farmers Branch going into downtown, it always flowed freely until you go over around downtown and that is understandable because that is where the main flux of people are. Everyone is coming or going out of downtown.”

Participant 3 – “I think 35 too, here in Fort Worth needs to do what they did going south toward Austin. Like, Burleson was only two lanes but now it expands out to 4 or 6. That has helped on that end, but when going out toward Denton, it is bad.”

Participant 2 – “That is confusing going out toward Denton though because there are all these exits you can take. And when you are in the center lane, if you ever try to get there and you have people going every which direction, that is a good place to have a wreck. Especially if you are not familiar with the area, because you have Rosedale going one way and east going one way. Now they have the new freeway up there but it is just real confusing.”

Moderator – “Now when you say it is confusing, what is confusing?”

Participant 2 – “Well if you are not in the exact lane that you need to be in.”

Moderator – “So, some of the lanes are exiting to the left and some are exiting to the right?”

Participant 2 – “Yes.”

Moderator – “I thought that is what you were saying but I just wanted to make sure.”

Participant 2 – “That is exactly what I am saying. And there are a lot of people that have to take the other lane because they are not in the right lane and now they have to go way out of their way because they missed where they needed to exit. Yeah, so that is real confusing.”

Moderator – “Participant 6, how is your travel on 35?”

Participant 6 – “Well I used to go to Denton because I used to work that route. So I had to take 35 to get to Denton but I didn’t have any problem with it. It goes a long way. So, I have no problems with it.”

Moderator – “Okay. What about you Participant 7?”

Participant 7 – “Actually, when you all were talking about Alliance, I used to have an internship out there when I was in college. I did it for one semester and they asked me to come back a second semester and I didn’t want to because driving took so much time. Not because I am lazy, but just because the drive there was long and I still had to come back and do some classwork. So, I was considering moving closer to there but that would not have worked out because I still had to take classes. Once I got closer to Alliance, like around 15 minutes away it wasn’t that bad. But getting there in the first place was quite a challenge getting there every morning, especially during peak hours, so.”

Moderator – “So, I think most of you have said that you have experienced the congestion getting worse over the last several years. Would you all agree with that?”

Everyone but Participant 6 acknowledges yes.

Moderator – “Participant 6, would you agree with that? Because you kind of said that your drive is fine.”

Participant 6 – “Well I used to live in Dallas County, and then I moved to Tarrant County in 1991. So, so far I haven’t had any bad experiences on 35.”

Moderator – “Okay, you don’t get stuck in traffic?”

Participant 6 – “No.”

Moderator – “Do you travel during the peak period?”

Participant 6 – “Well, maybe once or twice I have gotten stuck but it doesn’t usually cause me any problems. But all of the highways could be wider. Because I went to Houston for a checkup and they have these wide highways. And here, ours are just narrow.”

Moderator – “So when you say wider highways, you mean like adding lanes?”

Participant 6 – “Yeah, like multilane. Add more lanes.”

Moderator – “Tell me how many miles your commute is and how long does it take you?”

Participant 2 – “To get where?”

Moderator – “Like if you are going from home to work or something.”

Participant 2 – “I can’t speak on that because it doesn’t take me long?”

Moderator – “It does not take you long.”

Participant 2 – “No, it takes me like 5 minutes; maybe 6 minutes at the most.”

Moderator – “So, you don’t have to commute on 35?”

Participant 2 – “Well actually I have to come off of 35 but it is on and off. It is real quick.”

Participant 5 – “My commute on 35 always ends up during peak hours — 4-5 o’clock. And when I am coming into town that is the only time it gets congested. And that is really because of the drivers because it gets confusing down there. When I really think about it I am not stuck in traffic that long.”

Moderator – “But about how far are you going?”

Participant 5 – “Going about 10-15 miles. It takes me about a good 20-30 minutes.”

Participant 3 – “I used to do the 35W south to Hillsboro everyday because I used to be the marketing manager at the mall there in Hillsboro. But going down it wasn’t bad but coming back like through Burleson was bad, but now they have added more lanes. Now I actually go to Alliance because of contract work and I actually live on that side. So, that is where I notice a lot of the 820 mess and on 35 right there. It usually takes me about 15-20 minutes, just depends on if there is a wreck or something. Roundtrip it is 35-40 miles.”

Moderator – “But what takes you 15 minutes? To go how far?”

Participant 3 – “About 15 miles.”

Moderator – “So, you are moving right along.”

Participant 3 – “Yeah, like I said really only if there is a wreck.”

Moderator – “Do you travel during peak hours?”

Participant 3 – “Yes.”

Participant 7 – “I only live about 10 miles away from work. It takes me about, if I leave early, it only takes me like 20 minutes. But if I leave closer to peak it might take me 25.”

Participant 1 – “Mine is real similar to yours (meaning Participant 7). I am only 15 or 25 minutes. It is only 10-15 miles. I seem to like start and stop in the morning or afternoon. I have had good luck in the afternoon.”

Moderator – “Participant 4, I know that you said you are semi-retired, so do you try and avoid the peak?”

Participant 4 – “I do and my commute is downtown to the city archives, library, county archives. It is about 9 miles on 35E. Off peak it could take only 15-20 minutes, or it could take closer to an hour. It is kind of hard to tell. More often it is closer to 15-20 minutes, but occasionally it could be an hour.”

Moderator – “So, is there a problem with reliability?”

Participant 4 – “Absolutely. And closer to the downtown area.”

Moderator – “So, when everyone travels to work, do they travel alone in their car?”

Everyone nods yes.

Participant 1 – “I am sorry to say, I would like to carpool with someone but I just have no one to do it with. I would, I would.”

Participant 7 – “I have been considering it.”

Moderator – “So, everyone would like to carpool?”

Everyone nods yes or says yes.

Moderator – “Now Participant 1 says she would, but have any of you really looked?”

Participant 1 – “I really did. We even have a board.”

Participant 7 – “Everyone in our office does their own thing because we are a smaller firm. Some people leave early and some people come in at like 8. So, since it is not huge – most people just do their own thing.”

Participant 5 – “Where I work, most of the people live in Mansfield or Arlington, so the company is in Mansfield. I don’t know anyone coming out this way.”

Moderator – “What about transit, do you all have transit options?”

Participant 2 – “Yeah, a lot of people where I work use the transit system, and before I got a car, I did too. The problem with the transit system is that it is just not reliable. Even though it says it will be there at a certain time it doesn’t mean it is going to be there at a certain time. You know,

buses can be up to an hour or two hours late. And if you are trying to get to work on time, buses aren't reliable."

Moderator – "Now, Participant 7, you work downtown too, right?"

Participant 7 – "Yes."

Moderator – "Have you ever considered using transit?"

Participant 7 – "I actually tried. But you can't really plan on it. You can't plan it down to a five minute window really. The wait time, of course we live in Fort Worth so you really can't compare it to New York. But there is such a big difference. There it is consistent public transport, but here you are like waiting and waiting and waiting."

Participant 2 – "I would actually have to leave two hours ahead of time just to make sure that I made it to work on time. And then you take a chance of being there an hour ahead of time."

Participant 1 – "If we had a system like New York, I would use it all of the time."

Participant 5 – "Even if Fort Worth had a system like Dallas, like Dallas light rail."

Participant 2 – "It doesn't make sense that on Sundays if you work after 6 o'clock or if you have to be at work before 6 o'clock you are just stuck."

Moderator – "Now, you said that the Dallas system works really well. Are you talking about the light rail system or the bus system?"

Participant 4 – "I don't know the bus system, but the light rail system is really good. They are moving a line much closer to me and it is going to be a really good alternative during fair weather. It won't take me exactly where I need to go, but it will take me two or three blocks from where I need to go. That I might not want to do in winter weather, but in fair weather. We talked about reliability earlier and absolutely I would vote for it."

Participant 2 – "Hmmm."

Moderator – "Now, Participant 2 you made a 'hmmm' about that?"

Participant 2 – "Well I am talking about the transit system in Fort Worth. I just wouldn't bet my job on it because you know I wouldn't depend on the transit system here in Fort Worth to get me back and forth to pay my bills. I have seen them go through a lot of different changes, public speaking and ask people what they need. But I have never seen them give the people what they need."

Moderator – "So, what is the biggest problem with 35 today?"

Participant 2 – "The holes in the road."

Moderator – "The potholes? So, you are saying the roads are not maintained well?"

Participant 2 – “In my opinion no.”

Participant 1 – “The big trucks, they wear me out too.”

Moderator – “Well that was going to be my next question, are trucks an issue?”

Everyone nods their head yes.

Participant 1 – “There does seem to be a lot more trucks for such a small area. There just seems to be a large concentration of trucks, that you don’t usually see like in Dallas.”

Participant 5 – “Well you have to understand that with Fort Worth being the hub around Arlington and all of the little suburbs and they are all growing like around Arlington and Mansfield. So, the population is getting bigger and increasing so everyone is driving and it is getting more congested.”

Participant 4 – “I am going to play the age card here. You talked about the difficulties of 35, in the urban segments much of it is that 35 grew organically and as a result there are still artifacts that make it like a crazy road. Left hand exits, I know why those left hand exits are there because I saw them lay the concrete as it became Stemmons Freeway there and I know why there are certain bends and forks. It results in leaving certain artifacts. I don’t know around Alliance, but I know there were some crazy jogs around 35 and I have a feeling that you are describing an artifact that we would not put up with in the 21st century but that we would under an Eisenhower era.”

Moderator – “So, what do you do about that Participant 4?”

Participant 4 – “Well I don’t know, you can’t short of – well, I guess there are a couple of things. You can slash and rebuild but the re-engineering now with a lot of the difficulties, like all of the financial difficulties – that would be hard to justify. We are talking about a corridor that is built from scratch for the 21st century that sounds like a solution. Or, at least easing some flow.”

Moderator – “Now what are you talking about when you say a new corridor?”

Participant 4 – “Hadn’t we talked about a new corridor that was going to be built off of the pathway off the current 35?”

Moderator – “Well that is one of the current things we are about to move into when we talk about what we do about the future.”

Participant 4 – “I have heard that proposed and I have seen that mapped out. That is one solution. The other solution is to tear down and rebuild section by section. That seems awfully expensive and awfully (?).”

Moderator – “Participant 2 is saying no on that one.”

Participant 2 – “I was born in 1969 and they are still working on roads from when I was born.”

Moderator – “So, you don’t have any real confidence then?”

Participant 2 – “No, I don’t I am sorry. It is still not finished. They come in with a new plan as they develop. So, now they are going to make it wider and put in four lanes there. But they have been working on it since 1969?”

Moderator – “So, are you saying they should have put four lanes in, in 1969?”

Participant 2 – “No, I am not saying that. But they should have completed something before then. They couldn’t have come back and made the lanes wider by now? The lanes that they should put in – where did that money go?”

Moderator – “Okay, well we are not going to talk about money yet. But we will get to that. Talk to me about all of the areas growing; Mansfield, Arlington. I have some handouts that will probably not show you the most recent push. But they do kind of look at the growth. I want you to take just a few minutes to look at them. This first page shows us the population in Segment One for the counties and you can see how the population was in 2000 and what is expected in 2035. I think someone mentioned all the growth to the north of here. So, when you look at Denton and Collin County that is some pretty substantial growth here. Does anything about these numbers surprise you? What surprises you?”

Participant 4 – “Yeah. That Cook and Grayson aren’t projected to grow to the same percentages that the rest of these areas are. I guess that is because they are out of the current growth bubble for the next 25-30 years.”

Participant 6 – “I have a question. 35 goes all the way up to Oklahoma right? How far north does it go?”

Moderator – “It goes to the Canadian border.”

Moderator – “You can see on here there is a projected increase of 79 percent in 2035. That is a pretty significant population increase. Do you agree with that?”

Participant 1 – “Population wise. Well, I suspect it is hard with the economy though where people are going to go. It is going to be the best place where people are going to get jobs. So, I guess probably.”

Moderator – “Remember that we are thinking 25 years down the road. If you look at the growth that has happened in Texas over the economic downturn that we have had, Texas is one of the only states that is still adding jobs. All of the people that forecast those things say that will continue because of the iron belt and the Snowbelt.”

Participant 7 – “Yeah and it is the best place to start a new business.”

Moderator – “The bottom chart shows us how long it will take you to get to work and what it did in 2008. In the 15-29 minute range it actually improved and between 1990-2008 a lot of projects got implemented here.” (Jokes about Participant 2’s comment about Rosedale – and reminds them that is a city problem not state and we are talking about 35).

Moderator – “If you look at the second page it is a map that shows you some of the daily traffic volumes in 2008. Along I-35 it shows you how some points, which show you how many cars were on the road and the second one shows you percentage of the total number that were passenger vehicles. The third number shows you trucks.”

Participant 5 – “As in 18-wheelers?”

Moderator – “Yes, as in 18-wheelers.”

Participant 2 – “So, does it look like there are less 18-wheelers traveling?”

Moderator – “Well if you read this thing on here it says that between 2000-2008 out of the locations where data were available the truck volume increased in greater proportion to the cars. So, that would tell you that there are more trucks on the road. So, if you are coming down from Oklahoma, you come from 17 percent to 20 percent to 20 percent to 13 percent and then at some point south of 820 a lot of those trucks get off because then you are down to 8 percent. But it does look like more trucks are taking 35W than 35E, percentage wise. But, that is just percentage wise. You can see there is a lot more volume on 35E than there is on 35W.”

Participant 4 – “And more passengers getting on, not necessarily more trucks getting off. If you calculate the percentages out in the total you have an increased number in the net trucks but a greater increase in the number of private automobiles.”

Moderator – “And then if you flip to the last page, what we have here is the level of service map. It is a formula that takes into account the percentage of trucks, traffic volumes, and the following distance. It is all kinds of things that go into calculating that. But it is a grading scale just like in school from A-F however we have an E in the level of service map. A, B, C are good for the most part. A is that you are traveling in the middle of the night and there is no one else around you because cars around you feed into the formula too. It would be like you driving down the road with no other cars around you. When you get to E, you are experiencing a lot of stop and go, sounds like what some of you have described your commute as now. F is a lot of gridlock. So if you look at the map at the top you see the 2008 level of service. Coming down from Oklahoma you see everything is pretty good as you come into Fort Worth.”

Participant 1 – “Until you get to 28th Street.”

Moderator – “Where is that?”

Participant 1 – “28th Street.”

Participant 5 agrees with Participant 1 – “I know exactly where that is.”

Moderator – “Well it doesn’t say that here on this map. But I guess you know exactly where this is. Then if you look at the map on the bottom that is the level of service anticipated in 2035, you can see that looks pretty bad.”

Participant 5 – “You know I have traveled to Oklahoma really this month 5 different times. Where this is on this top map is where it is backed up, especially around 4-5 o’clock but



sometimes even 3 o'clock. Right past Denton, it backs up a little before the fork. When I saw that I thought about it – I have done this recently.”

Participant 1 – “Yeah where two comes into one.”

Participant 5 – “Yeah.”

Participant 1 – “Where 281 feeds into W. It feeds into 35W there. A person coming from downtown can go 281N, but a person coming from south must go in from 35 because they never built a ramp. It is weird.”

Participant 1 – “This is a lot like 35 in Austin. Where it just stops. Bumper to bumper, especially in Lake Riverside. You live there so you know it is horrible, and that is how Dallas and Fort Worth are going to be. I definitely think they should open that up because Austin needs it desperately.”

Moderator – “So, what will we do to open this up? So, how do we fix this problem?”

Participant 7 – “I think that if we think of a way without building because then you have the wait time. But I like the idea of carpooling. It is just something that the younger generation perceives as not convenient for us. But if there were more opportunities to promote carpooling and if it were tied into social networking like Facebook groups or communities online where people from the same work area or school area could go online and find people that are already going that way. You know something like existing like an online community, where you already know someone so you are not driving with a stranger. But more of like an accepted idea or easier so people don't have to e-mail someone and initiate it. I would love to do it and I think people my age would do it but it just needs to be more convenient. If there was a way to access a pool of people that wanted to carpool that would be easier.”

Moderator – “So, Participant 7, why don't you create something like that?”

Participant 7 – “Oh I would love to with some of my friends but I am going to be moving in a month and half and when I move my new roommate and I will be carpooling.”

Participant 2 – “I would make the transportation system that already exists more efficient for the people. One of the things that most people have a problem with is that they say most people will not use public transportation because it is not convenient and not reliable. You know, on Sundays we still have to go to work and why do you have a system that shuts down at 5 p.m. on Sundays?”

Participant 6 – “Do they have an HOV lane like they do in Dallas? They don't have that right? So, why don't they add that?”

Moderator – “So, would an HOV lane make you more likely to carpool?”

*Participant 5, Participant 6, and Participant 7 all agree that it would make them more likely to carpool.*

Participant 3 – “And the trains, if we have the trains like Dallas does.”

Participant 6 – “Why don’t we have the HOV lanes like Dallas does?”

Moderator – “I don’t know. (Jokingly) “I ask the questions here, I don’t answer them.”

Participant 5 – “I also believe that comes with the population and the growth. You look back 8 years ago and it was not this big and I know we are talking about 35, but they are pondering the same thing in Arlington right now. Arlington and Mansfield was just dirt and now it is communities everywhere and now that they have the stadium they are considering public transportation. So, when it comes down to it, it is the people, history, and if you are ready for this. Whether you are ready or not, the growth is here so you are going to have to expand or it is going to be bad.”

Participant 1 – “I-75 in Dallas used to be two lanes and now it is expanding. It is so much better now. That used to be the nightmare of nightmares. So, if they can do that with 75 with all of the houses on top of houses they can do that here.”

Moderator – “So, can they widen 35 here and do you think that is a reasonable solution?”

Participant 3 – “It would help.”

Participant 4 – “It seems to me there are 3 ways to ease congestion. You can add more road capacity by adding lanes. If you have 4 lanes, then you add one lane, you increase capacity by 25 percent. So, you could add more road capacity. You could reduce the number of automobiles by incentives of transit — public transit. Or, disincentives like higher gasoline, road taxes, or tolls, or you could make greater utilization of the roadway that you have. Greater utilization means that you take out curves so that average speeds could increase or you devise a means for cars to travel only 4 inches apart instead of 20 feet apart at high speeds. And I think the thing we have been focusing on is more capacity with fewer cars.”

Moderator – “So are you saying we should look at more technological solutions?”

Participant 4 – “Well, I wondered if there might not be a fourth or fifth way. Just sitting here, I can only come up with three. But yeah, there might be some technological solutions that allow us and maybe it is a low tech solution taking out some of those artifacts. The average speed of Central Expressway increased by not having those humps that it had, by leveling the grade – that was a factor for increasing the speed.”

Participant 1 – “That was a huge improvement.”

Participant 2 – “On 35W South on the side of the freeway, you have housing developments, you have schools over there so if you widen out the roads what do you do about the people that live there?”

Participant 4 – “You gut it out. They are doing the same thing on 183 in Irving.”

Participant 1 – “Yeah, they did the same thing on 75 and they did it, and in that area...”

Participant 2 – “Have you seen the transit and the homeless statistics in Fort Worth, Texas, alone? Have you guys ridden down Lancaster?”

Participant 1 – “Yeah.”

Participant 2 – “Yeah. So if you take out all those houses that have people living in them now — that subsidized housing — and you get them out and they have no where to stay that just makes Lancaster that much more congested with homeless people living there.”

Moderator – “So you are saying if we added lanes in certain parts...”

Participant 2 – “That would be a bigger problem for the community.”

Participant 2/Moderator – “Because there is a lot of low income housing over there.”

Participant 3 – “In Nashville they moved the missions and stuff when they did the roads up there downtown and it helped. And I think there are a lot of missions and Salvation Army over there in Lancaster and that is why it gravitates over there.”

Participant 5 – “Is that what you are referring to the historical Participant 4? The artifacts?”

Participant 4 – “Yeah the artifacts that are left over, the crazy curves. Central Expressway was built between automobiles that traveled at speeds going 45 miles an hour and there was an awful lot of this going under underpasses. It was an earlier time in engineering and by flattening out that grade to a greater degree you could increase automobile speed, which increased capacity and that was an artifact left from an earlier time. Those left exit lanes that loop and fly and slow because they scare drivers are artifacts left over from a different engineering philosophy. And at some point you have to decide to cut them out; if the challenge is to increase capacity that is one way to do it.”

Participant 2 – “They were just built here in Fort Worth maybe just four years ago, that new one, that interpass. The Mixmaster that is right over downtown that hits into 35.”

Participant 4 – “Well, yeah, there was a version of that going back to the time that they built.”

Participant 2 – “It is not even five years old right, maybe 7-10 years old? But that was something that they just put into existence.”

Participant 3 – “Well they made 35 loop further around to have more lanes and stuff, so it doesn’t go through downtown; it takes you around the post office and stuff.”

Moderator – “Sounds like we have a couple, several different solutions. We have incentivizing, carpooling, improving transit so it is a viable option; the HOV lanes because that helps incentivize carpooling getting more people out of their car; making carpool arrangements easier (lets sum that up that way).

Participant 4 – “You can disincentive travel.”

Moderator – “Well we haven’t gotten there yet. Did I say adding lanes? I know you all said adding lanes too. Technological fixes perhaps; geometric fixes, upgrading the highways, and reconstructing them to increase thru cut.”

Participant 2 – “Take the cars off the road and put them in the air.”

Moderator – “Oh yeah, that has been a long time coming.”

Participant 1 – “Does this take into account that there are...I’ve heard that with computers more people are working out of their home?”

Moderator – “This estimates how many people they think will be doing that at the time. That is certainly another strategy to encourage.”

Participant 1 – “Because it is becoming more and more. And people wouldn’t be making the commute.”

Moderator – “Or, maybe not at peak hours. But do you think if you took some of the cars off of 35, if you didn’t expand it or add any lanes, if you took some of the cars off of 35 do you think it would fill up with people that are taking alternate routes right now?”

Participant 2 – “Like buses and bicycles?”

Moderator – “Not necessarily talking about bicycles but a lot of people said they would do whatever they can to avoid I-35, so they are taking surface streets. Participant 4, I think you said you take surface streets. So if you made it better on I-35 do you think all those people taking surface streets are going to get back on I-35?”

Participant 5 – “Yeah, as soon as they see there is no traffic jams.”

Everyone agrees.

Moderator – “So how do you solve that problem?”

Participant 4 – “You don’t. It seems like that is the contradiction inherent to this business — that a road creates its own business, it creates its own traffic. You put a highway down and people will find it easier to get into downtown to work so they will build houses out on the highway, so it builds up the highway.”

Moderator – “So you have a whole chicken and egg thing.”

Participant 4 – “The road creates its own traffic.”

Moderator – “So, let’s go back to something you said just a minute ago Participant 4. What about disincentives? You said tolls, increased fees, like what if you charged a daily fee to get into downtown Dallas or downtown Fort Worth.”

Participant 4 – “You laugh but that is what they are doing in New York.”

Participant 2 – “That is like paying to park to go to work (laughs).”

Participant 4 – “You laugh but that is what they are doing in New York City.

Moderator – “Well they tried to do that but it didn’t work so well.”

Participant 2 – “It does discourage you from driving every day; it would help with the carpooling, and public transportation, and alternatives like riding a bicycle and jogging to work.”

Moderator – “So do you think it is fair or reasonable to do something like that?”

Participant 5 – “I don’t. I don’t. I don’t. The roads are built for us to have easy access. So if you have a toll road, so singularly yes I would love to have a straight way to work so I would pay a toll. However, I don’t think that is the main focus for the people and that may be political, I am not going to go there.”

Participant 2 – “I think it is the cost.”

Participant 5 – “Yeah I believe the cost. The cost is adverse to what we are trying to do because the roads are for the people.”

Moderator – “What do you mean the cost is adverse to what we are trying to do?”

Participant 5 – “A toll road would probably eliminate some of the traffic.”

Participant 2 – “It would help maintain it.”

Participant 5 – “But the road is there for the traffic to have access to it. Why should there be a road? I am going to tell you as a matter of fact, the North Dallas Tollway, I can get on North Dallas Tollway and there is no traffic.”

Participant 1 – “Right. Right. And it was supposed to be paid for how long ago and they just continued with it being a toll road. A long time ago it was just supposed to be a temporary thing and it was going to be paid for and it’s not and now forever it is going to be a toll road.”

Moderator – “We are going to talk about the funding in a minute. Let me ask you this, what if you added a lane or two to 35 and that one lane was a toll lane so if you were late to work you could take it?”

Participant 1 – “Kind of like an HOV lane?”

Participant 2 – “So you have a choice? A choice?”

Moderator – “Yeah, an HOV lane or a toll lane or one of the other options is a HOT lane, which is a high-occupancy toll lane. So, if you are carpooling you could go for free and if you are driving by yourself and it is worth your time you could pay.”

Participant 1 – “That is a cool idea.”

Participant 5 – “I like that idea, but it’s just the toll road.”

(Everyone likes the idea, nodding and saying yes.)

Moderator – “So what do you have to say, Participant 4?”

Participant 4 – “I think it had to do with – you were almost at that point, Participant 5, realizing that if you charge \$20 to drive on that road to the guy who tears tickets at a movie theater he is going to opt out at some point but the man who owns the movie theater is going to say that \$20 is not as important to me as convenience. So both the movie theater owner and ticket taker are both financing the road through the use of their automobile taxes. And as a result it becomes a rich man’s system, which doesn’t make sense.”

Moderator – “So you don’t think that is fair?”

Participant 4 – “No, I don’t think it is equitable. I would rather say equitable. But I don’t know, I can’t think that through with toll lanes and HOT lanes. There comes a point that it becomes inequitable, but I can’t define that.”

Moderator – “Okay. Well, I want to go back to trucks for a minute. You all said there are a lot of trucks on the road, but it doesn’t really sound as if this is a big issue for you on the road. Am I misunderstanding that? Is it a big issue?”

Participant 6 – “I have traveled 35 on the Dallas side and there are a lot of big trucks, I don’t think it is a problem.”

Participant 2 – “I think more of what we were talking about is the holes in the streets and that the trucks were causing them.”

Moderator – “That the trucks were causing them?”

Participant 6 – “After that last winter freeze — all the ice.”

Participant 5 – “I don’t recall the trucks ever really being a big problem. Unless I have seen 30 trucks at one time, unless the freeway is backed up. Seeing a few trucks here or there. There are a lot of trucks that travel 35. I love the big trucks.

Moderator – “You love the big trucks?”

Participant 5 – “I love the big trucks in traffic. Because then you can zip and zoom around them. Trucks give me an opening.”

Moderator – “Trucks hate it when you do that, you know that right?”

Participant 5 – “I am not clipping them.”

Participant 4 – “Let them fight it out if they want to.”

Moderator – “What if the one lane on 35 was for trucks?”

Participant 2 – “Would they have to pay?”

Moderator – “Maybe. What if they do have to pay?”

Participant 2 – “That is the same thing as the rich man and the poor man, don’t you think? Their job just happens to be driving a truck.”

Moderator – “Don’t you think they are going to pass that on to you anyway?”

Participant 2 – “We are catching it right now.”

Moderator – “Don’t you remember when the gas prices were really high and milk was like \$5 a gallon?”

Participant 2 – “Per cow.”

Participant 4 – “Austin has done that on sections of 35 — limiting trucks.”

Moderator – “Truck lane restrictions. Trucks can’t drive in the left lane.”

Participant 5 – “They have that here.”

Participant 3 – “I thought Arlington has that.”

Moderator – “Yeah it is a county thing.”

(A lot of chattering, everyone agreeing that it is on I-20). Participant 3 – “I think it is on 20?”

Participant 4 – “The truck issue has brought me back to the point that I was thinking about earlier. I make two uses of 35. Trucks are just a matter of course on my day to day travel on urban 35. Where they really torque me is when they are stacked up on the highway when making those long trips using 35 as a portal to other places.

Moderator – “Truck traffic is a huge deal in Austin.”

Participant 2 – “That is how things are transported back and forth. So we as customers can enjoy what they bring into the city.”

Participant 4 – “Dallas is fortunate. Dallas and Fort Worth are fortunate that we have some good loop roads.”

Moderator – “So the trucks aren’t driving through the middle of your downtown.”

Participant 4 – “Not supposed to.”

Participant 2 – “Trucks don’t really drive through downtown here.”

Moderator – “What if they built more new freight lines and more things were shipped by rail?”

Participant 2 – “Then wouldn’t that cause a job opening thing again, if they took the driving jobs away? Everyone needs to work. For some people, that is all that they know how to do. My dad was a truck driver.”

Moderator – “Well I want to go back to one thing that Participant 4 said about alternate facilities: parallel facilities. We talked about operational things we could do on 35 that exists, adding capacity to it. But what if you built a new facility, where would you put it and what would it look like?”

Participant 2 – “I missed something, can you repeat that?”

Moderator – “We talked about some of the things that you could do to the existing 35: adding lanes, adding HOT lanes, and do all this other operational stuff to make it flow better. But what if we built a new road; where would it go and what would it look like? Participant 4 had mentioned something about it initially so I wanted to go back to it.”

Participant 5 – “Are you talking about revamping 35?”

Moderator – “No, a new 35...”

Participant 2 – “Could you do what they did in Ft. Worth 30 downtown? They kind of left it open but built over it.”

Moderator – “Okay, like double decking the existing 35.”

Participant 2 – “Yes, a double decking.”

Moderator – “Okay, where would that start and stop?”

Participant 2 – “35 starts downtown coming off of 5th Street. Going around a circle like this. So that would probably be the best place to start it going toward the north side toward 28th Street.”

Moderator – “So you are talking about going from downtown going north.”

Participant 2 – “Yes, and you could probably start it the same way going toward the south. They have one road starting in Lancaster that goes south and one road that goes around and goes north 35.”

Participant 3 – “But are you talking about going out of the city?”

Moderator – “I am asking you all.”

Participant 4 – “I am going to give you a history lesson. The history lesson is when you used to drive to Austin you used to drive through every pig path between here and there. You would go through Italy, Waxahachie, and Midlothian and all these little towns and stop lights and you would be parallel with the rail road tracks. Sometime in the 50s, maybe the 40s, they began engineering this huge interstate thing so they went way out of town east of town and west of



town and this big highway went through and that was the interstate. So the path of the interstate is actually offset, sometimes significantly offset, from the original highway that went to Austin.

Participant 2 – “So are you saying start at the end? Start at your destination to get to where you want to start?”

Participant 4 – “If we are talking about the 35 corridor and we are talking about a great percentage of through put and we are talking about local use we are not going to go way out here to get to work but we are talking about local use as one use, and portal to portal use. Going up to Oklahoma and down to Austin, maybe it does make sense to offset a new corridor from what the traditional one is now. Why double deck? Just make one that goes way out of the way.

Moderator – “For the people that are driving to Oklahoma to Austin.”

Participant 4 – “From Mexico to Canada.”

Participant 2 – “So where would the people get off that need to go to the mid-cities?”

Participant 4 – “You wouldn’t.”

Moderator – “I think what Participant 4 is trying to say is you wouldn’t take that route for the people that want to get off in the mid-cities.”

Participant 2 – “How is that convenient for the people in the mid-cities?”

Moderator – “The people that are here that are using this will keep using 35 here.”

Participant 1 – “And those people who do will.”

Moderator – “Is that a solution?”

Participant 1 – “It is a thought.”

Participant 3 – “I know that when you go to Austin on a holiday it is bumper to bumper from Hillsboro all the way to Austin, you know where it splits.”

Participant 4 – “Well you might be going there to bring little Collette home for the Christmas holidays but that trucker that has truckloads of turkeys doesn’t need to follow that highway. He could be following one 20 miles to the east.”

Participant 3 – “That is why I said something needs to be done because I know they are fixing where the two 35s come together there in Hillsboro.”

Moderator – “So Participant 3, Participant 4, and Participant 1, you three have been talking about traveling outside the Dallas area. I don’t want to put words in your mouth, but, it sounds to me like you are saying 35 is worse outside of the metro area.”

Participant 1 – “Well I am more familiar with Austin and absolutely, 35 in Austin.”

Moderator – “What about the trip from here to Austin?”

Participant 1 – “Yes, during the holidays. I used to drive a 67 Mustang back and forth and if I was sitting there too long it would overheat and get stalled and I would have to pull off; oh it was horrible. But during the holidays it is even worse.”

Participant 3 agrees.

Participant 3 – “Yeah and going up to Oklahoma during the holidays it is crazier. Like this weekend we had it worse with the race going on out at Texas Motor Speedway.”

Participant 2 – “Do you ever notice that people try to get to the same place and try to leave at the same time? So maybe leaving a little bit earlier.”

Moderator – “And that was one of one of the things that Participant 7 said about the carpooling. And Participant 1 talked about teleworking and starting at different times of the day.”

Participant 6 – “I think 35 is just outdated. It needs to be updated. And it needs to be modified.”

Moderator – “All of it?”

Participant 6 – “Yeah, all of it.

Moderator – “From where to where?”

Participant 6 – “35 where the HOV lane is on the Dallas side is okay. They need to do that in Tarrant County further south.”

Participant 5 – “And from the fork on 35 where they meet back up going north to Oklahoma.”

Moderator – “So where the north comes back together?”

Participant 5 – “Yeah, that section there only has two lanes.”

Moderator – “So they need more lanes?”

Participant 5 – “Yes, they need more lanes; 35 needs to be widened.”

Participant 1 – “And that is what they did with Central because at some points it is two lanes.”

Participant 5 – “They are working on it after Oklahoma on the way to Wichita, Kansas.”

Participant 3 – “Fort Worth city needs some help; 35 too, not just going to Austin and Oklahoma. We need some help right here.”

Participant 2 – “Yeah just right here in Fort Worth.”

Participant 5 – “Well what Participant 4 was saying I didn’t think the numbers were going to match. But I see if you have an alternate they would match.”

Moderator – “So you like Participant 4’s idea of having an alternate route.”

Participant 5 – “So intercity traffic doesn’t have to worry about people who don’t need to drive in the city.”

Participant 4 – “If I was going down 50 years ago to see Aunt Martha in Italy then we could take it and it would be really easy to take the road. But if we were going to Mexico and wanted to go the fast way we could stay out of Italy, Midlothian, and all the little towns.”

Moderator – “Okay, so we have talked a lot about different options; of course, there are a lot of different price tags for these options. So, let’s talk about funding. Before we actually start talking about it I want to know what you know about funding. So do you know how your transportation is funded?”

Participant 2 – “Through my tax payer money.”

Moderator – “What tax payer money?”

Participant 2 – “All of my money.”

Moderator – “Let me qualify what we are saying here. We are talking about highways primarily; roads that TxDOT is responsible for, the interstate, what is that 287 out here? No county roads, not Rosedale. We are talking about FM roads, the interstate, major highways.”

Participant 2 – “Does it come through emission testing, inspection stickers, tax and title?”

Participant 3 – “Federal funding.”

Moderator – “What federal?”

Participant 3 – “I know there is certain federal funding with match.”

Moderator – “Participant 4?”

Participant 4 – “I was going to say when it was first put in, in 1919, it was 50/50 state and federal. I know gas tax is in there but I am not sure what percentage goes to the state?”

Moderator – “Anybody else have any ideas?”

Participant ? – “Well you mean like the taxes we pay that a percentage goes to the state?”

Moderator – “I am specifically asking you how roads are paid for. Not how roads are paid for but how transportation is paid for. That is everything from mowing the grass on I-35, to the signage, building a new lane, bridge inspection.”

Participant ? – “Now the tolls are funded by the federal government right.”

Participant ? – “No, the tolls are funded by the tolls that you pay for them.”

Moderator – “Everybody give up. Well, Participant 2 was on the right track and Participant 4 was on the right track. Your highways are primarily paid for from the gas tax. There is a tiny, tiny, tiny percent that comes from vehicle registration fees, but most of that goes to the county in which you register your vehicle. The same applies with emissions testing. Anyone have an idea how much you pay in gas tax or how you pay?”

Participant 5 – “I know it is a small percentage and it is all added together.”

Moderator – “It is not a percentage, it is a flat fee you pay. You pay 20 cents per gallon for state fuel tax and 18.4 cents for federal fuel tax. You pay a total of 38.4 cents. I said you pay a flat fee. So, when gas is \$4 a gallon you pay 20 cents; when it is \$1 a gallon you still pay 20 cents. You got that?”

Moderator – “The last time the gas tax was raised was?”

Participant 2 – “Last year.”

Participant 5 – “’08.”

Moderator – “Participant 5 says ‘08’?”

Moderator – “1991. So, almost 20 years ago.”

Participant 2 – “So the price of gas going up, no tax has been added to it for almost 20 years?”

Moderator – “Yes, that is absolutely right. Does that surprise you all?”

Participant 3 – “Wow.”

Participant 2 – “Wow.”

Moderator – “Does it also surprise you that of that 20 cents that is collected for state gas tax, 25 percent of that (so a nickel) goes to fund public education?”

Participant 4 – “Yeah, that does surprise me.”

Participant 1 – “Yeah, it does surprise me.”

Participant 2 – “It surprises me, especially with the drop in public education.”

Moderator – “What do you mean the drop in public education?”

Participant 2 – “There are less kids graduating from high school.”

Participant 5 – “Yeah, I know when they were talking about toll roads and that is why when I said percentage I used the wrong terminology; I meant centage, a small amount of cents because when they were talking about toll roads they said all this same stuff.”

Moderator – “So it seems like there is a little bit of dismay about what I said.”

Everyone agrees.

Moderator – “So do you think you pay enough? Now I know everyone feels they pay enough, right? Now you said (looking at Participant 2) taxes before, so you think you really get taxed a lot?”

Participant 2 – “Yes I do.”

Moderator – “But then I told you that you are only paying 20 cents a gallon.”

Participant 2 – “But where are the other taxes going? Because when I look at my check, I see taxes for a lot of stuff.

Moderator – “So, you mean your paycheck.”

Participant 2 – “Yeah, not just that; when we pay the light bill, the gas bill, and when we go to the grocery store. There are taxes for everything we do as a society.”

Moderator – “But your transportation is only funded from the fuel tax.”

Participant 2 – “Okay.”

Moderator – “Only the gas tax.”

Participant 2 – “So does that mean anybody that doesn’t buy gas for their car doesn’t pay for the highways?”

Participant 4 – “Well think about it; they aren’t using the highway, they aren’t buying gas.”

Moderator – “Well that is not true.”

Participant 2 – “Yeah, I know that is not true.”

Moderator – “What about people with electric cars?”

Participant 4 – “Ohhh.”

Moderator – “Only thing they pay right now is vehicle registration.”

Participant ? – “Good point.”

Moderator – “So do you think as fuel efficiency increases and we have federal mandates to increase efficiency, what is going to happen then?”

Participant 3 – “There won’t be enough money.”

Participant 2 – “What about people that use public transportation; are they not paying any tax?”

Moderator – “They are not paying any gas tax; public transportation is done at the city level. So I don’t know what they do in Fort Worth. So the city collects a tax.”

Participant 2 – “And that doesn’t go to you guys.”

Moderator – “Not us, I don’t work for TxDOT.”

Participant 2 – “I mean it doesn’t go to TxDOT? So, each city that is getting money for roads and maintenance, are they not putting their money together to do these things? So are they just holding on to their money and fixing their roads individually?”

Moderator – “Well that is a complicated question. In some instances, the city collects property tax and some sales tax to a certain extent, and then they use that for maintenance and building their city roads. But if they have a project like....”

Participant 2 – “A new freeway.”

Moderator – “Yeah, I-35 or something like that the city is usually required to share in the cost of the project. Depending on what type of project it could be 90 percent state and federal and 10 percent local match. But the local match doesn’t have to be money; it could be right-of-way, which is money too, local engineering, and environmental work.”

Participant 2 – “So if they match something that is not money, then the money that they collected for their roads and streets, what happens to that money?”

Moderator – “Well they are using it for other projects in the city. It might be going to the library; I don’t know.”

Participant 2 – “Okay.”

Moderator – “Now that we know a little bit about the funding situation. What are the options that we have?”

Participant 4 – “Can I ask you a question real quick?”

Moderator – “Sure.”

Participant 4 – “What is added to that 15 cents a gallon; are there federal government funds that are added?”

Moderator – “To that 15 cents? When you include the federal part of that, there is a little more than 15 cents. Well, it is hard to say because you get the 15 cents only because you are looking at the state portion. But if you combine the federal portion the percentage is a little bit different.”

Participant 4 – “States kicking in. I mean the federal government.”

Moderator – “The federal government is kicking in. Because you do pay that 18.4 cents to the federal government and Texas gets that back, but Texas is also considered a donor state so for every dollar Texas sends to the feds they are getting back about 92 cents because they are

subsidizing other states' highways that are not very populous, like the highway that goes through Montana. Does that make sense to everyone?"

Participant 6 – “So then they have a surplus of money to do what they need to do.”

Moderator – “They who?”

Participant 6 – “The funding from the taxes from gas for the highways.”

Moderator – “So you are saying TxDOT has a surplus?”

Participant 6 – “Right.”

Moderator – “Not necessarily, because right now they are spending more than half of their budget maintaining what they already have. They have more than 78,000 miles to maintain.”

Participant 6 – “Maintaining meaning repairs?”

Moderator – “All of it, meaning guard rails, bridges.”

Participant 2 – “So, Texas as a donor state is taking money to help other people who fix their roads and highways and we as the state of Texas need to come up with ways to get money to fix our roads.”

Participant 4 – “Not quite. The feds are doing that. It isn't our money to begin with; the feds have swooped in and collected it and said we will give you dollar for dollar back for what we collect in Texas because we are nice guys or we will give you 92 cents for every dollar because we want to help our neighbors in Montana. But that 92 cents is more than what we are collecting.”

Moderator – “Well it is not more than what we are collecting.”

Participant 4 – “Well it is in addition to.”

Participant 2 – “Yeah, I get that.”

Moderator – “Okay, so we talked about electric cars, increased fuel efficiency and gas tax not being raised since 1991. So what are our options to pay for all of these solutions we came up with?”

Participant 2 – “Get a bicycle.”

Participant 7 – “Increase the gas tax. Or implement some sort of tax for people with electric cars.”

Moderator – “Okay, so tax the people with electric cars.”

Participant 7 – “And/or increase the gas tax.”

Participant 1 – “I don’t know anyone with electric cars, where are they?”

Participant 2 – “Hybrid cars?”

Moderator – “Well not hybrid cars. They are still buying gas.”

Participant 2 – “I am like her; I don’t know anyone with an electric car.”

Participant 4 – “They are coming.”

Moderator – “We are talking 25 years into the future. We might be flying and then we won’t have to worry about this.”

Participant 4 – “There is our aero car.”

Participant 1 – “There is a movie or something about destroying the electric car because the Big 3 — they destroyed all the electric cars because they don’t want them around because of all the things they would get rid of if we plugged them in, instead of having to deal with Mobil and all that.”

Participant 2 – “I don’t think technology will allow that to happen. We are growing and as far as technology is concerned it is coming whether we want it or not.”

Participant 5 – “What would happen if we went to an all-electric society? That will take away all that money, right?”

Moderator – “Absolutely.”

Participant 5 – “The government will come up with something.”

Moderator – “What if we didn’t pay gas tax anymore?”

Participant 1 – “It would be in the electric bill from charging your car.”

Moderator – “But that won’t go to transportation, that will go to the electric company.”

Participant 2 – “If we lose the gas tax, our streets are going to look worse than they already do.”

Participant 4 – “I think what she is asking the concept of gasoline maybe a twentieth-century concept. Let’s think an energy tax; whatever type of energy you get like electro energy from plugging in your car or natural gas, or coal fired automobiles.”

Participant 2 – “You have TU and Direct Energy already trying to divide up the money for electricity for our house and then if you include our cars in that too then it becomes like the internet service — you are going to have everyone around the corner trying to get paid for it.”

Participant 4 – “No, I think what she is saying or what I am hearing and thinking about is that tying your revenue source to the means of transportation which was gasoline at the first of the twentieth century which makes sense because the cars that are still on the road were gasoline.



But in the twenty-first century we are going to be using alternative energy sources so it is not directly derivative anymore.”

Participant 1 – “Have you ever driven in a hybrid car? I had a friend that searched the internet for them. I am not that high on them honestly. I think they are okay. They are a good alternative to what I have now. But I mean I would love to go with a completely electric car.”

Moderator – “Let me ask you, Participant 4 was talking about changing the tax collection to a new mechanism. But what if we did away with the gas tax altogether and just paid based on a mileage fee?”

Participant 7 – “How would you calculate that? When you take your car in to get inspected they check that?”

Moderator – “There are all different ways to do that.”

Participant 1 – “Like every time we take a turn we have to pay a toll.”

Participant 2 – “It would decrease your travel time where you are going to. People would move closer together if you had to pay a tax for every mile. My family would move closer to me.”

Participant 4 – “They are charging by the mile right now at the pump at the QT.”

Moderator – “You are essentially paying per mile right now based on the gas mileage.”

Participant 7 – “That helps with a lot of issues like you said with the gas, regardless of what car you drive it is not based on the energy source but how far you drive and that automatically makes you do things like reduce the number hours you are on the road and makes you think of energy efficient ways to be off the road.”

Moderator – “So you think that is a good idea?”

Participant 7 – “Yeah, but I don’t know how you fix that amount because I think everyone will have differing opinions on what it should be.”

Moderator – “So that is an option we have out there.”

Participant 2 – “Would it depend on how much you make an hour, on your gross salary, like everything else does — like your hip living, where you live.”

Moderator – “But your gas tax does not depend on that.”

Participant 2 – “Yeah, but if we tax it any other way than going to the pump that should matter shouldn’t it?”

Moderator – “I don’t know, should it?”

Participant 7 – “But now it doesn’t matter if you make \$100,000 a year or \$50,000 a year; you are still paying the same price.”

Participant 2 – “Do you know how many people don’t eat to put gas in their car?”

Participant 7 – “I can’t even imagine.”

Moderator – “So what other financing alternatives do we have?”

Participant 3 – “They could sell sponsorships on the road.”

Moderator – “This freeway brought to you by McDonalds.”

Participant 1 – “It does seem to be the way we are going.”

Participant 7 – “When you do your taxes they could have something that if you have one car or two cars or by your income? That is an alternative.”

Moderator – “So you said increase the gas tax too. If they did that, what is a reasonable amount?”

Participant 7 – “What did they increase it by last time?”

Moderator – “I don’t remember; it has been twenty years.”

Participant 7 – “Oh, I didn’t know if you knew.”

Moderator – “I don’t know off the top of my head. Think about this; gas prices fluctuate by a few pennies all the time. Do you pay much attention to that?”

Participant 2 – “I sure do.”

Participant 3 – “Yes I do.”

Participant 2 – “It is up to \$2.80 right now, when it was just \$2.62.”

Participant 4 – “I recall about a year ago there was a discussion about raising the tax because the price was going down. The idea being that the consumers wouldn’t notice if we were on a downward slope on gasoline. I just remembered that and it makes sense now.”

Participant 2 – “Wouldn’t it be something for the people that sell the gas, couldn’t we tax them?”

Participant 7 – “Then they would tax us.”

Participant 5 – “The 20 cents that comes out for gas is a flat fee; it has nothing to do with gas prices.”

Moderator – “What if we adjusted that. What if instead of paying 20 cents a gallon you pay 10 percent of the price?”

Participant 2 – “And then the price never went up again.”

Moderator – “I didn’t say that, that has to do with the oil companies. Or what if you even connected the amount you collected, the tax, to the consumer price index so it rises with inflation? We talked about how it hasn’t risen in twenty years. Everything has risen in twenty years, right? So does that seem reasonable? Participant 6?”

Participant 6 nods yes, Participant 2 nods no.

Moderator – “Participant 2, you are still saying no.”

Participant 2 – “It would help the value of cars to go down. I don’t think GM would be making as many cars as it is making right now.”

Moderator – “Because the gas is going to cost too much?”

Participant 2 – “Yeah.”

Moderator – “And then people will be out of jobs again?”

Participant 2 – “I don’t know, I think bicycles are going to come back.”

Moderator – “Maybe those people that are working on cars can work on bicycles.”

Participant 3 – “I know GM is going to build a plant to make more efficient cars.”

Participant 2 – “Instead of building more cars that we don’t have money to pay for the roads that we have now?”

Participant 6 – “I have lived in this area all my life and I have seen this area grow and you need to keep up with demand. So the roads need to be updated with more people.”

Moderator – “And what is your solution for paying for that?”

Participant 6 – “More taxes.”

Moderator – “Participant 3?”

Participant 3 – “I think they should increase the tax if it hasn’t been increased but also create new ways of bringing in money like sponsorship, HOT lanes, and you still have to keep in mind the little guy who can’t afford the tolls.”

Participant 6 – “One more thing: who decides how much tax gets taken out of gasoline?”

Moderator – “That would be your state legislature. And the part that goes to education is constitutionally mandated.”

Participant 6 – “Most people don’t know about that tax. I didn’t know about it. Because I have to get gas almost every day.”

Moderator – “Well good, we like you.”

Participant 7 – “As far as public education in the future how are they planning on dealing with that?”

Moderator – “This is just my own personal opinion and I should turn off the tape recorder right now, but I can’t imagine TxDOT ever going to the legislature and saying we don’t want any more diversions. Not only does gas tax fund public education but it also funds the department of public safety and a few other small programs, so they don’t get that whole thing. But can you see TxDOT going to the legislature and saying we don’t want to support public education anymore? Can you imagine it would be a battle between state agencies?”

Participant 4 – “This has been interesting for me. Because I grew up with a system in the twentieth century locked in, and never thought that we needed to think of this differently. For those of you who are inheriting the system that my parents helped build and I used all my life, you have to change it. You have to change the way we pay for it and the way we use it.”

Moderator – “And it is not just on a state level but at a federal level, too, where you really have some policy issues that are complete opposites of each other. You are taxing the thing you use to finance your roadway system for gas and yet you have federal mandates that say fuel efficiency has to increase by X percent such and such year.”

Participant 4 – “The thing you have to remember, this whole business is relatively new right about 80 years ago, or 90 years ago was the first time the federal government said we need to help states build interstate roads so we are going to put money into the states.”

Moderator – “And states actually started doing that before the federal government did.”

Participant 4 – “Exactly. At the start of the century, right before automobiles started coming in the responsibility for rural roads was the person whose land it went in front of. You may have been asked by your county sheriff to work on it, then the county started to come in. Then the state said these automobiles are coming on faster than what they can do so we have to start taking away responsibility from the counties.”

Moderator – “Some of the very first roads were toll roads. It was truly a user pay system.”

### **April 21, 2010 Waxahachie, TX**

Moderator: “Let’s start with how you travel on I-35. Does anyone commute on I-35? I bet Participant 1 does.”

Participant 1: “I travel fast. Fast every chance I get. I use I-35 daily to commute from DeSoto to Ellis County.”

Participant 2: “I travel I-35 when I have to go to Baylor, but it got so bad with the construction, it was awful, so I switched to I-45. I-35 is life-threatening when you’re going to Baylor Hospital. It’s bad!”

Moderator: “It’s pretty bad when you’re going to the hospital for a life-threatening illness and you’re taking your life into your own hands on the highway!”

Participant 2: “Yeah! So I just go the other way—it may be a little longer, but it’s a lot smoother ride. You don’t have to worry about stopping and going, and you don’t have to worry about the construction.”

Moderator: “Okay. Who else? Participant 3, I know you’ve only been here for a short time, but do you travel up and down I-35?”

Participant 3: “I travel I-35 every day I have to go to work, and when I start school I’ll have to also. Before I actually lived here I took I-35 about everyday to come here from Lewisville.”

Moderator: “And how was that trip for you?”

Participant 3: “It depends on when you go. I mean, between 4 and 7 the trip is bad when you’re going 10 miles per hour or so the entire time, and then there is a wreck, and a wreck inside of that wreck. So...”

Moderator: “Okay, so when you’re talking about traveling from Lewisville, remember we’re not from around here, are you taking 35E or 35W?”

Participant 3 was not sure if he was using 35E or 35W, so there was some discussion among group members, and they determined that he was traveling on 35E from Ellis County to Lewisville.

Moderator: “What about you, Participant 4?”

Participant 4: “You know, I’ve lived in the Dallas area all my life and I’ve traveled I-35. I have seen all the changes, and I hate the downtown loop exchange from Oakcliff area going around—that’s like the worst. My daughter is just learning how to drive and we have not even approached that area because it seems so dangerous. In Red Oak, working for the police department, we’ve suffered through all the construction going from 4 to 6 lanes, and even now we still have a lot of construction on the weekends. When are they ever going to finish?? The police department has to deal with all the wrecks on I-35, so I see all the reports and I see the danger that seems to be involved right there at our Red Oak exits.

Participant 2: “There are a lot of accidents at Ovilla Road.”

Moderator: “How far is Red Oak from here?”

Participant 2: “Eleven miles.”

Moderator: “Okay. What about you Participant 5, do you travel on I-35?”

Participant 5: “I don’t do it as much as I used to; I use I-35 to go to the VA hospital. I was a truck driver a long time ago and I’ve seen some of the mistakes people have made. When I get

into the Red Oak, the exit by the bank is dangerous. My concern is the concrete barriers along I-35 from Italy to Red Oak. They don't give! I almost had a wreck on I-35 and hit the concrete barrier to avoid another car."

Participant 4: "What about the service roads — are they part of this too?"

Moderator: "Yes, we can talk about the service roads too."

Participant 2: "They're bad too!"

Moderator: "Some of you have been driving I-35 for a while. What I hear you saying is that you've seen it getting more and more congested. But, like Participant 4 was saying, there has been an expansion. Is that...?"

Participant 4: "And that is a good change, but it's just the construction that goes along with that. I guess the congestion is inevitable. One thing is they did change our service roads from being two-way to one-way. It has made getting somewhere **SO** inconvenient, especially in the Red Oak area. I experienced the same thing when I lived in Wilmer on I-45—it was the same way, from two-way to one-way. It put the Dairy Queen completely out of business because you had to go miles one way and then go back around to get to it.

Participant 2: "A lot of those businesses along the service road are no longer in business because they made that a one-way."

Participant 4: "I just don't think that was good a thing. I just don't see the purpose. I don't really know that we have accidents; I don't know what it was hurting having the two-way service roads. I'm sure there is a bigger picture, but I'm just not aware of it. It sure caused a lot of havoc in our town."

Moderator: "Well, maybe if you were aware of it, it would make a difference to you?"

Participant 4: "It might."

Moderator: "Okay. Now, Participant 1, you spend a lot of time commuting, right?"

Participant 1: "Yes."

Moderator: "Do you commute in the peak hours?"

Participant 1: "Yes, I have to spend a lot of time going over to Arlington, so I travel along I-35 to I-20 and then back up 360. It's ugly. I would rather take a beating than have to do that during rush hour, but it's interesting. I was listening to Participant 4 about the two-way to one-way and I could see why they had to do one-way because the ramps got so much longer and high speed. You couldn't yield anymore. But what I see is there aren't enough exits. As soon as you hit Ellis County, you've got to go two, three, four miles—it's a long distance—for some exits. There is an exit for Milford, then one for Italy, and then you don't get another one until you get almost to the

Waxahachie area. You really don't have enough access points, which causes you to have to go forever back up and around. As Red Oak keeps growing, you'll have to have some more exits, won't you?

Participant 4: "Well it would be overpasses. I don't know that the off-ramps are the problem, so much as when you're on one side of the highway to get around going to the junior high. It's such a long, long, long, long way to get somewhere when you've got to cross over to go this way to back that way, you know? I don't know if we need more streets cut through; I just don't know how we would do that either because of the houses."

Moderator: "What about do any of you travel on I-35 to go on long distance trips? To go to Austin, or..."

Participant 2: "Yeah—Austin, San Antonio..."

Participant 6: "That's the good thing about south — it gets you to Padre!"

Moderator: "Well, only to San Antonio, then you have to take another route."

Participant 6: "Well yeah, but they built something around Austin. To where you used to have to stop, the trip to Corpus is about 8 hours and you'd spend 2 hours sitting in traffic in Austin on I-35, but now they built the toll road around Austin."

Moderator: "So, have you taken the toll road in Austin?"

Participant 6: "No, I haven't been yet. But I will be going this summer sometime."

Participant 2: "I've gone there a lot because my brother lives down there. I have one that lives in New Braunfels, San Marcos, and Wimberley. If you want to get through Austin, you had better be through Austin by 9 o'clock, or else you're going to be sitting in traffic for three hours. Traffic is backed up all the way to Georgetown; it's just awful. It takes you forever."

Moderator: "So, do you think that part of I-35 is worse than it is up here?"

Participant 2: "No, that's a breeze. I would rather go more south than north any day."

Participant 6: "No, always go south."

Moderator: "But you just finished saying that you spent three hours sitting in traffic!"

Participant 2: "If you hit Austin at a certain time, you're going to be sitting in traffic, but you don't have to worry about all these crazy people trying to run you off the road and all this construction."

Moderator: "But up here, there are crazy people and construction?"

Participant 6 and Participant 2: “Yes.”

Moderator: “Okay. Participant 1 is nodding her head.”

Participant 6: “Traveling from I-35 to US-75 (going north) is fine, but it’s the coming back part through downtown — from US-75 to I-35 that is scary because if you’re not directly in line with the signs that say I-35 South through downtown, you have to make a really—I mean it’s scary at night.”

Moderator: “What do you think about HOV lanes?”

Participant 4: “They’re great, but why do you have to have more than one person? It seems like the HOV lane is more about...”

Moderator: “Well it wouldn’t be an HOV lane then.”

Participant 4: “Well, I don’t even know what HOV stands for to tell you the truth.”

Moderator: “High-occupancy vehicle.”

Participant 4: “Okay, then let’s call it ‘long distance lane’ or something.”

Moderator: “Okay.”

Participant 4: “Because that’s pretty much what it is. You get on it and you stay in that lane for a very long distance. It’s not like you’re in the other lanes and just going a very short distance and going off. It seems like they should make that more for...”

Participant 3: “Well wouldn’t anyone just take that lane then?”

Moderator: “I think what Participant 3 is saying is how do you make sure that the people in that lane are really going a long distance?”

Participant 4: “You keep them from being able to get off. I guess what I’m saying is that if there was a lane that was designed to go from where you get on the HOV lane now in the Oakcliff area and a place to get off in downtown Dallas for people who travel in the morning to downtown. That is kind of where I experienced it—I had to go to downtown Dallas in the morning for something and I experienced that horrible bumper-to-bumper I-35 traffic. I had to use my daughter to go with me so that we could use the HOV lane. We just flew to downtown! And I thought why isn’t there a lane that is designated when you’re going from Point A—the downtown area, the downtown area to north to Lewisville. There is a lot of traffic that is just through. I guess that’s what your left lanes are supposed to be about.”

Moderator: “But, the HOV lane that is there now does pretty much what you’re saying, right? From Oakcliff to the downtown area?”



Participant 4: “Yes.”

Moderator: “But what you’re saying is that maybe it should be expanded, maybe...”

Participant 4: “No, I’m saying that more people can’t get on it because you have to have more than one person in the car.”

Moderator: “But, remember that you said that you were on that HOV lane and you just flew through, right?”

Participant 4: “Right.”

Moderator: “Well, if you let everybody on, won’t it be another lane just like all the other lanes and be bumper-to-bumper?”

Participant 4: “I don’t know, you could also have the people who have to get off, who are getting on; they should be designated for certain lanes — people who are through traffic.”

Moderator: “I understand what you’re saying. So, the people that are driving from Oakcliff from downtown, but only have one person in the car—they’re stuck in the bumper-to-bumper traffic, but they’re really going. They have a straight shot.”

Participant 6: “It gets abused all the time.”

Moderator: “You think it gets abused?”

Participant 2: “ALL the time!”

Participant 4: “And they’re probably people like me who just have to get from point A to point B and weren’t on I-35 to get off in Oak Cliff; they’re just trying to get to the long distance where they took the HOV lane from here to downtown and got off and they just didn’t have someone in the car.”

Participant 2: “There are single people using it all the time.”

Moderator: “You know the fine is \$200, right?”

Participant 2: “My luck, I would get caught and everyone else would go free.”

Participant 1: “I work in downtown Dallas traveling from DeSoto, and used that lane for the little while my daughter was living with me, but there were police at the entrance almost every morning. There was no chance I was going to go on it without my daughter.”

Participant 4: “I guess, like when you’re going to Houston on I-45, don’t you get downtown and the people that are going straight through—you go over the traffic and the others go another way? I guess that’s what I’m kind of saying—I-35 should have a way to get through all of that so that you’re just staying on I-35; you’re not getting off, you’re just trying to bypass and go north.

Participant 2: "Like they have a road going around Austin?"

Participant 4: "I guess that's what I'm saying."

Moderator: "Okay, we'll keep those thoughts in mind. Before we move on, what do you think is the biggest problem with I-35?"

Participant 1: "Traffic."

Moderator: "Traffic, congestion. Okay, but congestion just primarily in the peak periods, right? Or all the time?"

Participant 2: "It's all the time."

Participant 1: "Semi trucks are the biggest thing I see."

Moderator: "Well, what about trucks?"

Participant 1: "You have more and more on the road, and they are now almost exclusively taking up one lane. If traffic has to stop I try to get away from any trucks in front of me because they are so slow at starting up, just because they're large."

Participant 2: "Trucks are really bad early in the mornings and later in the evenings. That's when you see them more out on the highway."

Moderator: "About what time?"

Participant 2: "Usually in the morning, when I used to commute back and forth to Dallas, you would see them from 6 to 10, and then in the evenings, usually about 5:30-6:00 they are just everywhere. SO when you have your peak hours..."

Moderator: "Trucks are driving in the peak hours?"

Participant 2: "Yes."

Moderator: "Well, are you sure they're just driving in the peak hours? Because that's when you're driving, but when you're at work you can't see them out there."

Participant 2: "Yeah, that's just my take. I don't know what they're doing when I'm at work! It just seems like that's when they're out."

Moderator: "But Participant 1 says that they're the biggest problem."

Participant 2: "They are the biggest problem."

Moderator: “Now, are trucks the biggest problem, or is traffic congestion the biggest problem and trucks contribute to that?”

Participant 2: “Trucks contribute to that, because if you get behind a truck—you’re stuck.”

Moderator: “What if there was a separate lane for trucks, kind of like what Participant 4 was talking about? Because the trucks probably aren’t going anywhere...”

Participant 2: “They wouldn’t obey it.”

Moderator: “They wouldn’t obey? Okay. They may not be going anywhere in Dallas, they could be going to San Antonio.”

Participant 4: “Well yeah, if we had those special couple of lanes you could bypass through, they would probably be in those lanes. And they would be flying like they always do.”

Moderator: “Okay, let’s keep going. I have some handouts I want to pass out that talk about what I-35 is going to look like in the future.”

Handouts are given out.

Participant 6: “I heard about that like 10 years ago. It sounds like a great plan.”

Moderator: “What plan did you hear about?”

Participant 6: “I’m not sure.”

Moderator: “Well, this doesn’t have a plan on it. That’s what I’m here to find out about from you—what the plan is for the future. This just talks about what we have to accommodate. So if you look at the first page, you can see that in Segment Two, the 13 counties, you can see the population in 2000 and then the projected population in 2035. So if you look at Dallas County—that’s obviously a big, huge jump there, but if you look at some of the smaller counties on the right hand side, like Johnson County, Ellis County, Parker and Kaufman—some of those populations are doubling between 2000 and 2035. And for this whole Segment Two area that we’re talking about, we’ve got a population going from 5.3 million people two years ago to 7.6 million people in 2035. Participant 4 is looking kind of wide-eyed. You think that’s a lot, right?”

Participant 4: “I’m thinking we’re going to get them all.”

Moderator: “We’re going to get them all in Ellis County?”

Participant 1: “Johnson County is really growing.”

Moderator: “So you can see that the population is projected to grow quite substantially. If you look on the second page, what we show here are some traffic volumes on different segments on I-35. We’ve got I-35W and E on here. The box on the left-hand side is the daily traffic volumes

and that was in 2008. The middle box is the percentage of that — that is passenger vehicles, and the box on the right is the percentage of trucks. For instance, if you look at I-35E coming out of Dallas, you have 32 percent of the traffic is trucks—that’s a pretty good chunk. So maybe you all are right about those trucks, right? And then if you look to the last page...”

Participant 4: “What would we do without those trucks though? As far as getting our goods from Point A to Point B? It’s so important.”

Moderator: “Sure it is! Do you think the good should be moved by trucks? What other alternatives are there?”

Participant 4: “Well, I don’t know that our train system is set up to move freight right now.”

Participant 2: “I don’t think the train is set up for that now.”

Participant 6: “No, but they’re supposed to have an Amtrak there.”

Moderator: “Well, Amtrak wouldn’t move freight; that’s just going to move people. But, do you think there should be some sort of investment in rail?”

Participant 5: “The tracks don’t always go right behind the warehouse, especially in this area, it’s so rural.”

Moderator: “So, upgrading freight lines doesn’t seem reasonable to you?”

Participant 2: “Not really.”

Participant 4: “I think they’re working on that.”

Participant 5: “In Dallas it might be, but not this area.”

Participant 4: “Over between Hutchins and Wilmer, there is a big facility there, and there is talk about the Lancaster airport being turned into a freight center. That was the long-term plan. I used to work for the City of Wilmer and that was seven years ago. They shot it down, but it is still in the plans. They have built a large rail facility and trucking center. There are a lot of warehouses in that area. I mean, I think they’re working on it, but it’s just going to have to come a long way to get our trucks off the road I think.”

Moderator: “That is what we would call an ‘intermodal facility.’”

Participant 1: “My concern is with ‘Big Box’ stores — the Wal-Marts, Target, everybody — because they use just-in-time-inventory. They do not invest in a large facility to store everything. They depend on those trucks to bring it in immediately because that’s what that cash register that’s scanning is doing. So, how can a train be just as responsive? That is one of my concerns.”

Participant 2: “Because that’s how they do their inventory now—it’s what they scan. People don’t go out and do the inventory anymore. If you scan it, it goes into the files. If you’re short, they pick it up and put it on the truck.”

Participant 6: “Their distribution center is in Cleburne.”

Participant 2: “Yeah, but that’s how Wal-Mart does their inventory, it’s how Target and a lot of these grocery stores do their inventory.”

Moderator: “So Participant 4 says that maybe it will work, but there are some concerns that it might not. Well if you look at this last page, the map is showing you what we call a Level of Service Analysis. A Level of Service is a formula that encompasses several things, including the traffic volume on the road, the percentage of trucks, how much following distance there is between cars. It takes into account a whole bunch of different things to come up with this Level of Service. It’s a grading scale, just like school, from A to F. If you look at the top map you can see that in 2008, on 35W right around Fort Worth—it was pretty bad. It wasn’t so bad for most of the other parts. If you look at the plans in 2035, that area on 35W and 35E gets a whole lot worse, and the other parts pretty much stay the same for the most part. They stay the same because in this modeling run that was done for 2035—it includes all of those construction projects that you are complaining about. It’s taking into account how when those projects are completed, they will make traffic flow better. So, the grading scale goes like this: an A is when you’re traveling in the middle of the night pretty much. You’re the only car on the road, there are hardly any other cars around you and you’re traveling at normal speed. An A through C are pretty good; C you’re moving right at the speed limit most of the time with a little bit of stop and go. When you get to D, E, and F is when it really starts to break down. An F is pretty much gridlock and an E is stop-and-go, stop-and-go. The chart on the bottom shows the vast majority of what we’re talking about here in Segment Two, that traffic flow doesn’t get that much worse. That’s because of the improvements that are already underway and that are planned. It takes into account what is in the plans for the next 35 years. Does that all make sense to you?”

Moderator: “So, looking at the whole handout that I gave you, is there anything that is surprising?”

*No answers.*

Moderator: “Participant 4 made a comment earlier that the growth that was going to happen was all going to be in Ellis County.”

Participant 4: “It’s a lot of growth. That’s what I’m most concerned with.”

Moderator: “But Participant 6 said that Johnson County is really growing too, right?”

Participant 6: “Yes. That’s a lot further south. See, there is a lot of land there. You’ve got Arlington then Mansfield, and then you’ve got Midlothian to Waxahachie and then Ennis. The movement south is growing a lot. Mansfield is getting kind of like Waxahachie. They built that

bypass around 287, now there are no trucks that can go on Main Street anymore, they have to go around the bypass. But, it seems like if you can't get in Dallas you go to the next city."

Moderator: "So do you think that's why this area seems to be growing, because Dallas is already so crowded — people are just moving south?"

Participant 6: "Yes."

Moderator: "Okay."

Participant 2: "I think a lot of people would rather work in a big city, but live in a small city. You have the hustle-and-bustle, then you come home to your quiet settled down little place. And if you want to do something, you can just go up there and do it and then come back. You don't have to worry about all the crowds and all the traffic."

Moderator: "So all those people coming are certainly going to create more congestion on I-35, right? So I'm here to find out—what do we do? Participant 4 already had one idea that we have a lane(s) designated for thru-traffic. But Participant 3 questioned how we would know, how would enforce that eventually, how would we know that those people are really thru-traffic, right? But then Participant 6 and Participant 2 both said something about a bypass, kind of like what they have in Austin, so that's a couple of different options that we have. Let's talk about the thru-lanes first. If we had the thru-lanes, south of Oakcliff—you talked about using the HOV as a thru lane, but we don't really have an HOV lane to use. So, would we take one of those regular lanes out and make it into a thru-lane?"

Participant 2: "That would just make it more congested for the other lanes if you add an HOV lane."

Moderator: "So would we add a new lane? I need your ideas — come on!"

Participant 4: "Make the HOV lane the thru-lane and the next lane the HOV lane if you have to have one."

Moderator: "Well, now we're squishing it down even more."

Participant 2: "Then it's squished down to two lanes."

Participant 4: "Well, you've got a lot of people in those two lanes that could be over in the other lanes going straight through."

Moderator: "So, Participant 4's concern is that the people that are in the HOV lane or the other lanes are really people that are getting off and on a lot, they're not going the long distance. But you're saying they should be."

Participant 4: "I'm just saying that you've got your people who are commuting inside your communities, and you've got your people that are traveling long distances."

Participant 3: “So, they’re traveling through those communities, but not stopping.”

Participant 4: “Of course, they do have to get off to get gas, food, but...”

Participant 6: “What about Amtrak from city to city? That’s what I was talking about earlier—I heard about this about 3 years ago. You were going to be able to travel...”

Moderator: “So you could get on a train in Dallas and go to San Antonio?”

Participant 6: “Yes.”

Participant 5: “Aren’t they talking about rail coming to Waxahachie?”

Participant 6: “Yeah.”

Moderator: “Is that a good idea? You would take that?”

Participant 6: “Yes—rail saves wear and tear on your car, it brings money into the counties...”

Moderator: “How does it bring money into the counties?”

Participant 2: “Are you talking about creating new jobs by building it?”

Participant 3: “Well that, and also are you saying that them paying for the tickets and the ticket money going toward the city.”

Participant 6: “So you would build it out in the rural...”

Participant 5: “Rail would be a lot of money to build. It was controversial in larger cities like Garland and Richardson.”

Moderator: “Do you think that rail would take the cars off of I-35? Would that cut congestion?”

Participant 6: “Yes.”

Moderator: “So do you think enough people would take that?”

Participant 5: “Yes, the percentage would be enough to take it.”

Moderator: “Where should the rail go?”

Participant 6: “I don’t know!”

Participant 1: “It should stop in the major cities. It should start in Dallas, stop in Austin and pick up passengers, then go on to San Antonio.”

Moderator: “So, Participant 1 thinks it should go to San Antonio. Participant 6 agrees with that. So if you took the train from Dallas to San Antonio, then what happens when you get to San Antonio?”

Participant 1: “How would you get around?”

Participant 4: “Rent a car.”

Moderator: “Rent a car, cab...”

Moderator: “You said that you have relatives in New Braunfels. Would you take the train from Dallas to San Antonio—what if there was a stop in New Braunfels? Would you take the train?”

Participant 2: “Probably. That would cut out my travel time. If the train stopped in the smaller cities, you would have time to visit and do sight-seeing.”

Moderator: “So it would be recreational for you?”

Participant 2: “Yes. It would cut down on traffic between Austin and San Antonio.”

Participant 4: “Now, it would have to be affordable to you.”

Participant 2: “Yes, it has to be affordable.”

Moderator: “And there has to be a way to move you around once you get to where you’re going.”

Participant 2: “Yes, and people who don’t have relatives there need to have an alternate way of getting around. Like shuttle buses or trolleys would be great.”

Participant 1: “Say you’re living in Waxahachie and want to go to Austin. Would you drive to the station in Dallas to catch the train—meaning you would get back on I-35?”

Participant 2: “You could catch a shuttle.”

Moderator: “So you think there should be a shuttle to Dallas? What if the train and it stopped in all those little towns along the way? You said that would be nice because you could go sight-seeing. But the trip you could drive would take you about three hours to get to Austin; what if it took you five hours on the train? Are you still going to go on the train?”

Participant 3: “Then again, a lot of people are on that train not to stop and go to each one of those cities.”

Participant 2: “That would be the same congestion that you have in your car.”



Participant 4: “What if you have a rail system that is on a schedule. This rail goes straight through from Dallas to Austin or wherever, then you have another one behind it that when they get to Ellis County gets off the main rail to stop and pick up people. The regular rail is still flowing, but the other rail makes stops in each county. The people who live in that county, instead of driving all the way to Dallas, they can drive to the station in that county. Or, you’ve got the option to go the long term.”

Moderator: “So you have an express and then a local. Kind of like bus service.”

Participant 4: “I guess that’s what I’m saying.”

Participant 3: “Then again, how long is the train going to be sitting there waiting? You said people wanting to get off to go visit the town, people wanting to get on don’t want to wait very long.”

Moderator: “Well, I think that’s what Participant 4 is saying, it would be on its separate rail, right?”

Participant 4: “It would have to be off the main rail.”

Participant 3: “That’s what I’m saying. It’s on its separate rail, and it goes to one of the counties. So someone—instead of driving—goes to the rail station in their county. Would they just be sitting there waiting to leave?”

Participant 4: “Yes. It would leave at a specific time. It’s kind of like getting on an airplane. You can’t just go to the airport and get on a plane when you want; you have to get on at a scheduled time, so you would have to plan your trip around the scheduled times for the rail.”

Moderator: “Okay, so what are the solutions we have to solve the traffic congestion on I-35?”

Participant 2: “An alternate.”

Moderator: “An alternate around. Where would we put it and what would it look like?”

Participant 2: “You could start it at Colorado where it really starts bumbling up.”

Participant 6: “Right at the bridge.”

Participant 2: “Yes. That’s a bad area because you’ve got people coming off when you’re trying to get over here and you go around that little loop to get over to this hospital. Start it there, bring it all the way through Dallas past the canyon.”

Participant 4: “Are you talking about double decking?”

Participant 2: “No! No double decking.”

Moderator: “No double decking, okay. So you build a separate facility that is a bypass starting at Colorado going through the canyon?”

Participant 2: “Right.”

Moderator: “That doesn’t get you to Waxahachie!”

Participant 2: “Well, that’s true. But there’s not that much traffic here.”

Moderator: “Okay, so the traffic is not that bad here?”

Participant 2: “It depends when you travel through there, you know? You could start it right there at Ovilla Road and make it go all the way around if you wanted to.”

Participant 6: “I don’t think the solution is going to be on the highway, on the roads.”

Moderator: “What’s the solution going to be? On the rail?”

Participant 6/Participant 3: “No. To decongest 35 is not going to be done by making alterations to 35. It’s going to have to be done by some other type of transportation.”

Moderator: “So what’s it going to be?”

Participant 6: “I don’t know.”

Participant 4: “We couldn’t go underground because of too much rock in Texas. That’s why I’m thinking we would have to go up over what we have now.”

Moderator: “Participant 4 is saying something like double decking I-35. She said that it needs to be at least two lanes, right?”

Participant 4: “Well, if you have a wreck you have to have a way to get around that wreck.”

Moderator: “So, are we talking about it being elevated or are we talking about it being like a bypass?”

Participant 4: “It would be nice to have a rail. It would cut down on how many people are on the road, but you still have to get trucks and commuters through town.”

Participant 5: “The bypass in Midlothian made a huge difference for truck traffic.”

Moderator: “If you built the bypass for I-35, Participant 4 says it would have to be at least two lanes. But, where would you put it?”

Participant 4: “Yeah, that’s the thing—you can’t bypass through downtown Dallas. The high rises—that’s why I’m saying the double decking is kind of like a bypass. The elevated lanes would be used for the through-traffic. They would take you up and over, and through.”

Moderator: “So maybe those should be the lanes for the through-traffic?”

Participant 4: “Yes.”

Participant 5: “Either way, we’re looking at money.”

Moderator: “Well that’s the next thing we’re going to talk about. But before we get to that, I want to mention one thing to Participant 4 about the HOV lanes. They are ‘high occupancy vehicle’ lanes right now, but what if you could, as a single driver, pay a toll. So the people that are carpooling, they’re going for free, but you, if you really need to be downtown...”

Participant 4: “I would do it.”

Moderator: “You would do it? You like that idea?”

Participant 4: “I used to have a toll tag.”

Participant 2: “You can buy a toll tag for a whole year.”

Moderator: “So, you all kind of like that idea?”

Participant 4: “I do. As long it was affordable, as long as you’re not really gouged for having your work in downtown Dallas. The real problem is that the industry is not coming out to where we live. We have to travel so far to make a decent living.”

Participant 2: “True.”

Participant 4: “In my particular case, I enjoy working close to my home, but I’m not making big bucks there either.”

Moderator: “So should Ellis County do something to bring more jobs here?”

Participant 4, Participant 1, and Participant 2: “Yes.”

Participant 2: “That is one of the reasons why I don’t work...”

Moderator: “Participant 1 works for the county, right?”

Participant 1: “If an industry wants to relocate and come to Ellis County, one of the first things they do is look at the transportation system. Ellis County is part of the 12-county region. You’ve been up to Frisco and all those places, and see how congested it is? There is really a crisis on the infrastructure—there is no money out there. Ellis has to compete with at least the Big 4 counties—Dallas, Tarrant, Collin, and Denton—because they are so heavily populated, they have more representation in the region and they make sure they get their dollars first. So, we have had

no success in getting dollars down into Ellis County. The other thing that I noticed on the maps here is that I-35 cannot be widened in Ellis County.”

Moderator: “Why is that?”

Participant 1: “Air quality.”

Moderator: “Okay.”

Participant 1: “And because the whole area has to be in conformity, and the region planning deal runs the model and says ‘These projects right here buy us a better air quality than these projects here,’ and they need to take care of all the air quality up to the north. If I-35 is to be widened in Waxahachie, someone else would have to give up a project up north. I don’t know of a soul that is going to do that.”

Participant 2: “It’s not going to happen.”

Participant 1: “I’ve tried. They don’t want to give up anything, so we’re kind of stuck.”

Moderator: “Well, the air quality issue aside, let’s talk a little about if we could do some of these improvements—how would we pay for them? Let me start with if you know how transportation is funded in general.”

Moderator: “Participant 5 says taxes. What kind of taxes?”

Participant 3: “City tax.”

Moderator: “Participant 1?”

Participant 1: “Gas tax.”

Moderator: “I want to make a distinction about what we’re talking about. We’re not talking about city roads, not talking about county roads. We’re talking about state maintained roads—you know the interstate, 287, farm-to-market, roads like that. Your transportation is funded primarily though gas tax—fuel taxes. Almost all of it is through fuel taxes. There is a tiny bit from registration, but most of that goes to the county. There are a few other little things like that. Do you know how much you pay?”

Participant 4, Participant 3, Participant 5 say no.

Participant 4: “They don’t put that on the pump do they?”

Moderator: “No, they don’t. They used to put it on the pump, but not anymore. Do you know Participant 1? Well, we pay 20 cents per gallon for state fuel tax and we pay 18.4 cents per gallon for federal fuel tax; so a total of 38.4 cents per gallon.”

Participant 1: “But there is another caveat to this. We don’t get all those cents back.”

Moderator: “We don’t get all of those cents back. The 18.4 cents for federal—we send that to Washington. For every dollar that we send to Washington, we get about 92 cents back. For the last few years, we got about 92-94 cents back. Texas is a donor state, so we’re paying for the interstate highways in the less populated states—like North Dakota, South Dakota, Montana, etc. They don’t have enough people to pay for and maintain the highways there. So, what I want to talk about primarily is just the state part of it. The federal part, we can’t do anything about that—send the money, get it back, it’s very categorized on what you can use that money for, those types of things. The 20 cents that you pay in the state gas tax—25 percent (5 cents) goes to education—the permanent school fund. That is constitutionally mandated. Most people do not know that fuel tax supplements schools. A small percentage, about 6 percent, pays to fund the DPS (state troopers). There are a few other minor things too. After you take all that stuff, you don’t have a whole lot of money left, right?”

Participant 4: “What percentage actually goes to the roads?”

Moderator: “Well, the other part of that is that TxDOT is spending more than half their budget to maintain what they already have. They have 78,000 miles of roadway they need to maintain, so we have even less to spend on double decking or elevating, or a bypass, or doing rail, or any of those things. Does anyone know when the last time the gas tax was raised?”

*No answer.*

Moderator: “1991—almost 20 years ago.”

Participant 4: “I think I know why.”

Moderator: “Why?”

Participant 4: “Because gas prices keep going up. I mean, how can they tack that on to people that are already feeling that we’re in a crisis about how gasoline prices already are? We would want to crucify somebody that wants to raise taxes on it.”

Moderator: “But when you go get gas and you see different gas stations—they are a couple of pennies different here, a couple of pennies there. Sometimes it will even fluctuate daily 10 to 20 cents. So if you added a penny to the gas tax, would you notice that?”

Participant 4: “No. That’s a very small percent isn’t it?”

Moderator: “The next thing I’m going to tell you is that when I say that the gas tax is 20 cents per gallon, it’s a flat 20 cents. It’s not a percent. So when gas is \$1 a gallon, it’s 20 cents, and when gas is \$5 a gallon, it’s 20 cents.”

Participant 4: “Yeah, if they only raised it one penny per gallon, I don’t think there would be much of an uproar.”

Participant 2: “But, 20 cents a gallon—you’d have people out for blood!”

Participant 4: “But, 5 pennies—we would notice that.”

Participant 1: “How much does a penny actually generate?”

Moderator: “Well, if you have a car that gets 20 mpg, and you drive about 15K per year, you’re paying, in state gas tax, about 1 penny per mile. Over the course of the year, you’re paying about \$255.”

Participant 4: “Wow.”

Moderator: “Now, you say ‘wow.’ Why do you say wow?”

Participant 2: “That’s a lot.”

Moderator: “You think that’s a lot?”

Participant 3: “Not as much as I thought it would be.”

Participant 1: “How much do you think \$250 gets you? Would it maintain a road or fill a pothole?”

Participant 2: “No, it won’t fill a pot hole.”

Moderator: “It seems like a lot when you’re saying this is how much you’re paying over the course of the year. When you look at registration, people are paying about \$60 per year, plus inspection, it’s like \$28. But, like Participant 1 was saying, in the big scheme of things, \$255 won’t buy you much.”

Participant 2: “It won’t buy you nothing.”

Moderator: “So, what are we going to do? Now Participant 4 said that maybe we could raise the gas tax a little bit. But what are our other options? You mentioned toll roads earlier—do you like the idea of toll roads?”

Participant 2: “They’re okay.”

Participant 4: “We’re probably saying that because we’re not living up in Dallas and we don’t use toll roads. I used to have a toll tag in the very beginning. I was in outside sales; I had to take the toll road all the time. It was nothing for me to spend \$35- \$50 per month on tolls.”

Participant 3: “One of the dumb things too it that even after the toll road is paid off, they are still charging people.”

Moderator: “Why do you think they still charge you?”

Participant 3: “I have no idea.”

Moderator: “Well, what did we just talk about? About maintaining the roads. Future tolls will be used for maintenance and operating the road. So it sounds like you all are kind of ‘toll roads are okay, but you probably wouldn’t use them, right? If we’re spending all of the money now on maintenance, we’re going to have to keep spending money on maintenance because the system can’t withhold. So if we don’t have any money for added capacity, we can’t build those extra lanes. What do we do?”

Participant 4: “I am willing to pay to get up on that elevated around town. That way, it’s not like I have to do that every day. People that are trying to go around the Dallas area would probably be willing to pay for it too.”

Moderator: “Okay. The other thing about financing that I wanted to make you aware of too, is—now if we’re using the gas to pay for our transportation, right? So, you all talked about using a little car, right? So you probably get pretty good gas mileage, right? What about electric vehicles—what are they paying?”

Participant 4: “Who do you know who has one?”

Moderator: “Don’t you think that over the next 25 years, more people will have them?”

Participant 4: “If it was affordable, but hybrids are...”

Moderator: “Right now electric vehicles don’t use gas, so they’re not paying anything but still using the roads. Granted that is a small percentage of the vehicle fleet on the road, but is that fair that they’re not paying anything?”

Participant 2: “No, I don’t think so.”

Moderator: “The hybrids are paying because they use gas too, but they use a lot less gas.”

Participant 2: “But they’re a lot more expensive than your regular car that you go out and buy.”

Moderator: “Right, but do you see that as the fuel efficiency in all types of cars increases, which it will over the next 25 years because of federal mandates that say so, we will be collecting even less gas tax? Does that make sense?”

Participant 4: “Okay, we could have electric stations. The vehicles would be made with a special plug so that you’ve got to go and plug it in to the electric station to get electricity. And charge...”

Participant 1: “But most people with electric cars charge them at home. Right now it just has an X amount of time it can go.”

Moderator: “I think what we’re trying to talk about here is that the vehicle fleet is going to change in the next 25 years so we have to think of a better/different way to pay for transportation.”

Participant 2: “There has to be more of a greener way. That would be better on the environment.”

Participant 4: “I don’t know how it charges, but it takes a long period of time to charge?”

Moderator: “I don’t know either, Participant 4. I told you that right now you’re paying \$255 per year for your car; what if we charged electric car owners \$255 to register their car?”

Participant 4: “Well, for one thing, the electric cars are probably going to cost more than your regular cars. Hybrids...”

Participant 5: “I get magazines from my electric company every month. They’re always talking about different types of fuel—corn, water, and different stuff. They’re saying in about 20 years, there won’t be any gas.”

Moderator: “That’s what we’re talking about.”

Participant 5: “All having to deal with the government. But they keep talking about different kinds of fuel. They talked about electricity, they talked about water, they talked about corn, coal...”

Moderator: “I hope we don’t have coal powered cars; could you imagine shoveling?”

Participant 1: “I hope we don’t have windmills on our cars!”

Moderator: “You know Participant 1, I’m wondering when we’re supposed to all have flying cars—getting to the Jetson’s thing.”

Participant 4: “I can barely afford my electric bill now. I mean I have been so poor for the last four or five months with \$500 electric bills that—how am I going to afford electricity for a car?”

Moderator: “Okay, let’s forget about the electricity for the car for a minute. Let’s just think about other funding mechanisms. You liked the toll bypass, right?”

Participant 2: “That would be good.”

Participant 4: “I would. But, if you can hardly get around town without having to pay a toll, then no, I’m not going to like that.”

Moderator: “Okay, and you sounded like you were okay with maybe raising the gas tax, just a little bit.”

Participant 2: “A little bit. Not to where it will jar you or anything.”

Participant 3: “Gas price is going to be going up, so they could increase the tax part of it too.”



Moderator: “That’s the point. What if we—you know I told you the gas tax hasn’t been raised since 1991, that’s almost 20 years ago, right? I don’t know of anything that hasn’t gone up in price in 20 years. What if we linked the gas tax to inflation, to the consumer price index or something? What if it was a percentage of the gas, of the total—like sales tax?”

Participant 4: “What about the people who are making the money off the gas?”

Moderator: “The oil companies?”

Participant 4: “The ones who made these huge profits off the gas. Why aren’t they supposed to...?”

Moderator: “So you think we should go to Exxon-Mobil and say ‘You need to pay us more’?”

Participant 4: “Yes.”

Participant 2: “They made billions and billions of dollars, just gouging people.”

Participant 4: “Why shouldn’t they be responsible for the roads too? If it wasn’t for the roads, they wouldn’t be making their money and their gas. So why do we, the little people, have to bear the brunt of the big industry, the gas people. They should have to be paying something else too.”

Moderator: “Okay. You’re not the first person that has said that.”

Participant 4: “I’m not? And I thought I was original!”

Moderator: “So, does anyone else have any other ideas?”

Participant 1: “I have one. We’re talking about \$200 some odd dollars, but that’s not maintaining the roads, is it?”

Moderator: “No, it’s barely, barely, barely maintaining the roads.”

Participant 1: “Because the cost of maintaining a road is just like everything else. The gas involved and the oils and everything else that it takes to maintain the road has gone up.”

Participant 2: “Labor has gone up too.”

Moderator: “But nobody wants the gas tax to go up.”

Participant 1: “So, we’re not taking care of what we have, we’re letting it fall down.”

Moderator: “And the more it falls down, the worse it gets and the more expensive it is to repair.”

Participant 2: “Maintain what you have, I guess. But you still need something around Dallas though.”

Moderator: “That’s what we’re talking about. How would we pay for that? Well, Participant 1 mentioned something, and it’s not really in the scope of what we’re talking about. But, Participant 1 was talking about something earlier—why don’t you tell everyone what you were saying.”

Participant 1: “Some of the thought on rather than doing the gas tax and because the alternative type fuels are coming in, fuel efficiency has gone down and we’re getting less and less of that gas tax. The figure she gave you was a dollar for today, but we were getting a little bit more back in 1995, but because inflation has hit us and fuel efficiency has decreased the number of gallons that you’re buying, the thought process is possibly looking at the number of miles that you drive. There has been a program, I think in Oregon, in which people have signed up and they are charged for the number of miles they drive. People like you that don’t have to travel across Dallas/Ft. Worth, but you’re usually doing your small commutes—do you actually put 15,000 miles on your car a year?”

Participant 2: “No.”

Moderator: “So, you’re paying less than that \$255.”

Participant 1: “But people like us who have to go out and do these meetings and everything, put 15,000 plus. My better half works in Southlake and works in DeSoto, so that trip is very expensive. So, we’re paying your part.”

Participant 2: “My husband used to work at the VA, and it was 88 miles round trip, so he was paying his part! I paid my dues!”

Participant 1: “Would you be willing to pay for the number of miles, rather than the gallons of gas?”

Participant 2: “It would all depend on where I worked, and how much I traveled.”

Moderator: “But, don’t you see that the people that travel a long way are already paying more in gas tax.”

Participant 1: “And they’re the ones that are on roads using them more than you.”

Moderator: “In the mileage-based user fee model, everyone pays the same. You can structure it different ways, but in this particular instance everybody pays for what they use. So if you drive 10 miles a week, 10 miles a day, or 100 miles a day...”

Participant 4: “What about the truckers?”

Participant 1: “Would that be acceptable for you? Say we were using 20 cents again, rather than placing that on the number of gallons that you bought, placing it on the number of miles that you drove.”

Moderator: “That way the people that drive electric or hybrid cars are paying the same amount as the people who drive regular cars or trucks.”

Participant 5: “What’s the percentage of hybrids or electric cars?”

Moderator: “I don’t know. I think it varies on where you are. They are a small market share. Participant 4 made a comment—what about the truckers? She says that a mileage-based fee might be unfair to truckers.”

Participant 2: “Yeah it would be because they’re the ones that do the long-hauls.”

Participant 1: “How much damage do you think a truck does to a road as compared to a car?”

Participant 2: “Oh, 10 times more than a car.”

Moderator: “The trucks may not be paying their share, but they do pay more in taxes than passenger vehicles. Okay, we’re almost out of time. I want to give everybody one last chance to say anything that they want to say about... you all have given us some ideas for solutions, and I thank you for your opinions and thoughts.”

Participant 5: “I think that L-train is a good idea.”

Moderator: “Okay, we talked about elevated lanes, for trains...”

Participant 4: “It’s okay, they’re going to build one and I’m going to look for my name on it.”

Moderator: “This train brought to you by Participant 4—The Participant 4 Express. Anybody have anything they want to throw out there?”

Participant 1: “We are in a critical situation because we’re losing infrastructure daily on a county level.”

Participant 2: “We can’t even maintain what we have, let alone build something new.”

Moderator: “Right, and I hope you all learned something about that.”

Participant 4: “I never even thought about all these things. It’s given me a lot of food for thought.”

Participant 2: “I never thought about it either—I just complained about it.”

Moderator: “But do you feel better now?”

Participant 2: “I feel better. I feel more informed.”

Participant 1: “Do you feel empowered to go do something about it?”

Participant 4: “Yes.”

Participant 1 (*paraphrased from hand written notes, not on recording*): Ellis County is concerned with the I-35 corridor: the existing alignment from Waxahachie to Dallas County is extremely developed. There are major industries where we get property tax from, which is relief to residents. If I-35 is widened, the road begins to encroach on industries and then the industries will go elsewhere. If we start widening in an urban area, we lose business—meaning the residents take on the tax burden. Ellis County is in a sad situation; the roads need to be repaired, etc.

### **April 22, 2010 Belton, TX**

Participants 1 and 2: I-35 is congested all the time.

Participant 1: Especially in Austin.

Participant 2: When we moved here 8 years ago there were a lot of cars but now we have 100K cars. You can't go out without seeing wrecks. It has gotten worse since we moved here, especially with the economy. There are a lot of cars but they seem to be moving all the time. It is “bumper city” when there is a wreck because there are no alternate routes for cars to use.

Participant 4: There are certain spots that bottleneck. You'll sit in traffic but then there is nothing (that seems to be blocking it). They need to have more access ramps. There are ramps only every 20 miles and people pull off into the medians and get tickets to avoid congestion. Something needs to be written somewhere that says that if you are just sitting there you should be able to get off the highway and “make your own trail.” Everybody does, and I try not to, but when you see a thousand cars sitting there you have to. There are just not enough on- and off-ramps. Maybe break it down into four lanes like in Hillsborough.

Participant 2: Yes, they need to add more lanes. We also need high speed rail in the area.

Participant 5: I-35 is packed and one the main reasons are the trucks. Most of them go slower than passenger cars which causes backup. On the ramp situation, I think there should be more exits but not as many entrances as those are what cause the bottlenecks. People can't merge and get up to speed correctly. We have some of the worse driving habits in the U.S. People don't know how to merge.

Participant 4: I agree.

Participant 5: And if we can't expand just have some better acceleration lanes. We need longer lanes so that when people get on they have more room to get up to speed.

Participant 4: Those on-ramps on 35 in Austin at the lower deck are a joke.

Participant 5: You have to go from 40 to 70 in a short distance on those on-ramps. You are automatically taking traffic down to the speed of the on-ramp.

Participant 6: The first time I ever came to Dallas and got on I-35 to go to Waco and Austin I thought it was a mini-freeway. It has two-way traffic on the access road and short on-ramps. The whole thing to me seemed so '25 years ago.' It's a joke to call it an interstate like what I-20 and I-40 are. They have acceleration lanes.

Moderator: Well the highway was built in the 60s and hasn't been improved.

Participant 6: But the ones I've been on were built at the same time as I-35.

Moderator: Typically, they are rebuilt based on volumes and now 35 is seeing significant increases in volumes. You've seen what's going on in Temple, right?

Participant 4: It backs up there, too.

Participant 1: You have to watch out with your truck.

Participant 3: Well I agree it is very congested. I will go 'backways' going into Temple but sometime you can't avoid it. I will take the tollway to avoid Austin. That area has definitely got problems.

Participant 1: It's too expensive to take a truck on the toll road. It's like 35 to 45 dollars for the trip.

Participant 1: Everything is relative. I've lived in Dallas and drove 20 to 30 miles on 635 and you talk about congestion...this is absolutely wonderful.

Moderator: I think a lot of you are using congested to say that a lot of cars are there, but it seems like traffic is moving, right?

Participant 5: All the way from Jarrell to Hillsboro is two lanes. But it seems like there is a lot of traffic between Waco and Temple and it is there all the time, no matter what time of day. There is a lot of traffic around Troy. Just go back and look at the number of accidents in that area, and nobody really knows why that is happening.

Participant 1: There are only two lanes there.

Participant 6: Seems like the truck traffic has doubled.

Participant 4: That's because of NAFTA.

(Moderator passes around handout.)

Participant 5: Is this after the recession? A lot of people moved here after the recession because of the Texas economy.

Participant 6: I read in the paper they were going to build 8 lanes through Temple. Is that true? The same article said the population is going to double.

(Moderator discusses population projections.)

Participant 6: But the population north and south of here is where the traffic is coming from. I don't think this area really matters.

Participant 1: You don't think the Bell County population is going to grow more because of the military base?

Participant 5: Really, the only thing that will fluctuate (with regard to the base) is the family size. They know how many people they will have and they move people off. Every year it goes up and down.

Moderator : Looking at other counties, like Ellis County...

Participant 6: That's amazing.

Moderator: Look at the traffic volumes...

Participant 6: It seems like the truck and passenger volume should be the other way around to me.

(Moderator talks about distribution facilities on 35 at Corsicana and potential reasons for the truck numbers.)

Participant 5: Hwy 36 comes through Waco and that is a major east-west corridor. I-35 is a north/ south route. People will go over to 35 and make that trip to Dallas or Austin from off of 36. We used to make that trip all the time in my old job going between Brownwood and Houston.

Participant 6: The company I worked for hauled between Sweetwater and (didn't catch...) and we made trips like that.

(Moderator discusses level of service discussion.)

Moderator: Segment Two is one of the few areas that does not change dramatically. A lot of it still operates alright. The reason it stays like that is all of the projects occurring over the next 25 years.

Participant 6: So this reflects the 8 lanes project (in Temple)?

Participant 5: And without these it would be all red?

Participant 4: Some will disagree but I don't understand this law about getting over when law enforcement has someone pulled over. I have seen some near misses because people see that cop and then have to get over. Problem is multiplied on down the road behind the officer from

everyone slamming on their brakes. I understand it's to protect the officer, but I-35 is like a "blood stream" and when you block it things backs up badly.

Participant 5: I think that's why they give you the option to get over or slow down. It gives you a way out. I support the law because having people pass you at 70 mph is dangerous. People can't correct their vehicle at that speed.

Participant 4: For example, if I have a flat I'm getting over as far as I can. Officers try to get on the other side and I agree about the need to save their lives but to save one you are putting 50 others in danger.

Participant 1: I had an incident like that just a while ago. Someone had a gooseneck trailer pulled over and I was in the middle lane. The guy in the right lane pulled in front of me and it was lucky that I was empty or I would have rear ended him.

Participant 5: That goes back to texting and cell phones in the vehicles. People are not paying attention and that is what is causing a lot of these accidents.

Moderator: So back to I-35...are there any surprises here?

Participant 6: I don't have any way of knowing what the actual statistics are so I'll trust you.

Participant 5: How many traffic counts did they do to get these numbers? If they just did one then it is not accurate.

(Moderator discusses traffic counts.)

Participant 1: I think they have a laser dude.

Participant 5: No those black things stretched across the road are what count vehicles.

Participant 3: This is not showing much growth for Bell County, but we are already adding more schools and there is talk of needing new facilities for kids.

Moderator: I think that it is because the 2000 population was so small. It looks like it is doubling. See?

Participant 6: If you were 50,000 in 2000, you would then be at 100,000...

Participant 4: If you want to see the true population of an area put a counter at the HEB. Those are packed all the time.

Moderator: So everyone agrees that the area is going to grow?

General "Yes."

Participant 4: And nobody has mentioned Scott and White. That sucks jobs in.

Participant 3: And the new children's hospital...

Participant 5: and the VA....

Moderator: So how do you accommodate this growth?

Participant 3: Expand I-35 and add the HSR. Put it along I-35 because that is where the traffic is. These data here show the traffic is all SOV so put them on the train. I've heard a lot of people talking about how they would like a rail between Dallas and Austin.

Moderator: So a rail line from Dallas to Austin or Dallas to San Antonio — is this a good idea?

Participant 5: No. Texans want their freedom and will want their car when they get there (on the train). People want to commute by themselves. They have transit in Dallas and Houston but is it maxed out? No.

Moderator: Need to keep in mind the difference between transit and HSR. People don't typically commute from Dallas to Austin.

Participant 6: When I lived in Dallas, I flew on SouthWest Airlines sometimes 15 times a week to get around the state and even Oklahoma. If they had had a railroad between Dallas and Austin there is "no way in hell" I would have taken a plane. You have to go to the airport and go through security and so on...

Participant 5: You are not going to get around that with HSR. They will have the same security and you will still have to drive to the train station. You are just using a different means but you still have to get to the station.

Participant 6: I lived in the suburbs of Chicago for years. I worked in the Sears Tower and it was just a way of life to take the rail. If there was rail here it would be crazy to not use it to commute into Austin, but it has to get you where you need to go.

Participant 3: You can use HSR to get into Austin along the main corridor and the main cities and then have smaller trains to make the smaller stops.

Participant 4: But can you just imagine what would happen if something happened to one of those trains, seeing as how bad traffic gets here when there is an accident?

Participant 5: The DOT would have to build proprietary tracks because they could not share the tracks with commercial rail.

Moderator: So we have the rail alternative out there...

Participant 6: I have a question...with HSR we are taking about passenger, right?

General "Yes."

Participant 5: What would be "sweet" would be a ferry style HSR where you can load your car on there and go to Austin or Dallas and then have your car when you arrive.

Participant 6: I like that idea.



Participant 3: That would be good for elderly people who need to go see family.

Participant 4: We have not talked about RVs.

Participant 1: They are the most dangerous thing on the roads.

Participant 6: Agree.

Moderator: How do we get trucks off the road?

Participant 3: They need to utilize trains more. The rail is there, so we need to use it.

Participant 4: There was a study that said if we utilize trains to their maximum capacity it would be significant.

Participant 5: Where I worked you had perishable goods, so you still have to have trucks.

Moderator: But what if the trucks are stuck in traffic?

Participant 5: Well that's an issue...

Participant 4: And then the train just goes right by you while you are in traffic.

Moderator (to Participant 1): Do you have tight delivery windows?

Participant 1: Pretty tight. I have to get there in time so that I can make my next pick up. The delivery window depends on where I am going. In Austin, I have to have a bigger window.

Participant 6: I was a dispatcher, and you don't want your trucks to have an empty load. If you see an empty flatbed well then that guy is not making any money.

Participant 5: We actually developed software that worked with multiple trucks that would coordinate pick ups and drop offs so that they stayed loaded. We had a certain LOS that meant the trucks had to be at the store at a certain time and if we did not make it, it was generally because of traffic on I-35. During the holidays that was all out the window.

Participant 6: They need a separate highway.

Participant 4: Have that in New York, but then cars get on the truck highway.

Participant 1: Sort of like what they have now with the lane restrictions between San Antonio and Jarrell. I don't like that. Sometimes cars know you can't use the inside lanes and cars will be going 55 to 60 on the two lanes that the trucks can run on. They need to get out of the way so we can run there.

Moderator: Does everyone agree that we need to add lanes?

All: "Yes."

Participant 4: What I don't understand is that this should have been done years ago. Instead of adding four lanes, we will now have to add 8 lanes just to get ahead.

Moderator: So, expand rail options and add lanes. If we add lanes, should they be on an old facility or new?

Participants 1 and 2: Add to existing.

Participant 2: They can find room.

Participant 5: If they expand I-35, they are going to take land along I-35. When they do that you will take what they tell you your house is worth.

Moderator: So are you in favor of expanding the current I-35 or having a new facility?

Participant 5: Expand I-35, but it won't solve the problem. We need a new facility.

Participant 2: But how can you say you don't want land taken and then want a new facility?

Participant 5: Eminent domain will happen regardless. Double decking is the only way to avoid that.

Moderator: What do you all think of that?

Participant 2: "Yikes."

Participant 3: What if you have an accident up there?

Moderator: Do you know people who commute from Belton to Austin?

Participant 3: No.

Participant 5: Even the HOP only has about 5 people in it.

Moderator: If they had their own separate lane, would it encourage use (by carpoolers)?

Participant 2: They have it in Atlanta and nobody uses it.

Participant 4: I have known people who cheat.

Moderator: So HOV lanes are not viable?

"No."

(Moderator describes HOT lanes.)

Moderator: What about HOT lanes?

Participant 6: That would be nice.

Participant 3: (Unsure.)

Participant 5: Is this a toll road? Nobody takes those in Austin. Nobody wants to pay to use roads.

Participant 6: I would use that like the one in Chicago (HOV) but I would say that 50 percent of the cars there were SOV.

Participant 3: But how would you enforce that with TxTAG?

Moderator: There are nine projects that are HOT; some are variable priced. Explains...

Participant 6: I think if you were going from here to San Antonio, and had one of those lanes about ten miles outside of Austin, and you were not planning on stopping, it would make sense to use it.

Participant 3: But we have the tolled loop. Why have that if you have a HOV going through Austin?

Participant 4: If I was driving and came to a complete stop and there was a toll road nearby I would definitely take it. In your focus groups, is there ever any resolution on these solutions?

(Moderator discusses toll facilities in Austin and how they don't help commuters.)

Moderator: What do you think are the best ideas?

Participant 5: Longer trailers (double 48s and triple 48s) would help truck traffic.

Participant 3: Hope they have something to deal with the accidents.

Participant 5: If you have a truck only lane, like HOV truck with longer trucks, you cut 50 trucks to 10.

Participant 4: One of the problems is the logs. Some drivers have to make up their logs. They are pushing the drivers from point A to point B, like Participant 5 said it is all service oriented...it comes down to greed and the truck drivers are just trying to make a window. We need to cut them some slack but the dispatcher's bottom line is to make money. Start with the companies and give them more of a window.

Moderator: So how does that affect congestion?

Participant 4: They are concerned with getting from A to B.

Participant 5: It's not necessarily the trucks causing the problem. There are a lot of bad drivers, but trucks are part of the problem.

Participant 4: Work on the good drivers. They know what they are doing. Then they can deal with the bad drivers. Look at who is getting a license at the DMV... little old ladies who get on 35.

Participant 5: What about technology? Most major cities have green and red markers on the interstate that tell you the road is closed ahead. People here just run up on lane closures.

Moderator: What about bigger signs that show travel time and congestion? Would everyone like that?

Yes.

Participant 5: It would be good for the signs to show travel times on 35 versus the toll road.

Participant 6: I think that is a great idea. I remember an article in the 60s about a cable that would run under the road that would take you where you need to go. It was supposed happen in the 80s. So, if we are talking about technology then according to those guys we should have been there already...

Participant 4: The technology is there, but the oil companies won't let it happen.

Participant 5: Powerful lobbies won't let the government move in that direction.

Participant 4: Obama was saying no drilling but now here he is drilling for oil. It's not his fault but he is getting pressure to do it.

Moderator: So how do we pay for all this? How is it paid for now?

Participant 3: Income taxes.

Participant 6: Interstate is funded by the 50 cent a gallon gas tax.

Participant 5: And those funds are earmarked.

Participant 4: I don't know...let me think about it.

Participant 3: If someone could take HSR they would not mind paying more for gas in taxes because they would be buying less gas.

Participant 3: Weren't all roads originally toll roads?

Participant 5: Sales tax.

(Moderator discusses gas tax.)

Moderator: Do you know the amount of the gas tax?

Participant 3: I know that gas wouldn't cost as much if they took the taxes off.

Participant 5: And they keep going up.

Participant 4: A few years ago they talked about doing away with the gas tax because gas prices were so high, but it was only going to take off like 30 cents.

(Moderator tells group the amount of the tax.)

Moderator: So Participant 3, you think it would be cheaper without taxes?

Participant 3: Well that's what I heard...

(Moderator discusses tax assessment.)

Participant 1: Well why can't oil companies, who have been making profits off the oil, pay more?

Participant 4: I'm not an expert in the oil business. You have independent drillers, and geologists charge a lot because they have to be right, and drillers take a lot of chances. When they hit a good one, they are going to make a good profit, but we're not talking about the independents. The big guys should "big time" pay more because they do it with no effort.

Moderator: When was the gas tax last raised?

Participant 4: Didn't they "chop it off?"

No.

Moderator: Almost 20 years ago was when it was last raised...not advocating, just discussing how it works. Federal mandates on fuel efficiency....What do electric vehicles pay?

Participant 1: Nothing?

Participant 6: And who will pay for the railroads if people using the railroads are not driving cars?

Participant 4: But think about it: The majority of the people are not rich. There are low income folks and if we jack up the price on the gasoline, they are not going to be able to make it to work. They are in a bad situation. Look how long it took to get minimum wage up. It's hard to live on that. The entities above (government) look down and say that we can live on that.

Participant 5: Two statements: There is a gap between electric vehicles and regular cars but there is also a gap between the number of cars now and when they last increased the fuel tax. They are getting more from more fuel consumed and more cars driving.

(Moderator discusses fuel efficiency affect on fuel tax revenues.)

Participant 5: My second statement relates to road quality: why don't they build them better? If they built them, better they would not have to fix them all the time.

Moderator: So you feel in Segment Two that you don't think you are getting your fair share?

Participant 5: Yes. Everything seems to be working fine north and south of here but not here.

Moderator: So we've talked about all these people coming here....TxDOT spends most money on maintenance...and yeah big cities get most of the money...but you do have some projects here....but will that be enough?

Participant 3: I doubt it. Seems we are always behind.

Participant 6: I lived right near 161 in Dallas and it took \$16K a foot to build that. But if you go out there right now and start it won't be that, and 38 cents a gallon won't pay for it.

Participant 3: And they are building a bypass around Temple. Wasn't there a lot of controversy about that?

Moderator: But you all just said we need to do something... add lanes, encourage more modes...so how to pay?

Participant 3: Income tax. There are people moving here and they should help out.

Participant 5: Sort of a toll road.

Participant 6: Gas tax is sort of a toll, right? The question is: would we be willing to pay 30 cents instead of 20?

Participant 1: I think oil companies should help out.

Participant 5: Car companies should help out, too.

Moderator: What about registration fees, etc....local option... specific to Segment Two?

Participant 4: What guarantee is there?

Moderator: But would you be willing to support a local option?

Participant 6: Most cars are foreigners (outside of region) driving through here. I might not drive on 35 for more than 100 miles a month. I wouldn't mind paying if it would help but...

Participant 4: I'm on the road all the time, and what (Participant 6) is saying makes sense. Put a "gadget" on people's car and whoever is using the road pays for it.

Moderator: So what about adding lanes to 35 that were tolled and went through the area?

Participant 6: That would help the area users. Our traffic would be minimal, really.

Participant 4: If there is a bottleneck, they will use it. Yeah, put them on there.

Participant 6: Do you have numbers on through traffic?

Moderator: What if we did away with the fuel tax (state) and just charged people for the miles?

Participant 5: And you expect them to be honest?

Participants 1, 4, and 6: How would you collect?

Participant 6: I don't think you could make it work but I wouldn't mind paying if it worked and everyone else was paying it.

#### Closing Comments

Participant 5: There is no one single answer for the question and problem that has been presented here. No silver bullet. However, there are a lot of people out there and if private industry and government worked and used technology it would work. Politics could limit the effectiveness. Is Texas willing to fund it, and is the government willing to take the hits on spending that money? Can they make the changes necessary (tighten belts)?

Participant 4: We need better people in charge. We are working ten years behind and we need to figure out the problem before it happens. Look at Austin: I have never seen a city run so "shoddily." As soon as they fix something, they are behind. If we ran our lives like that, we "wouldn't have any clothes on." The entities in charge need to be better equipped.

Participant 3: I would like to see it based on usage. Maybe that would force lower income people to carpool. I don't want any more taxes, income or other. Lower class people don't pay at all but still use the system. Middle class pays for everything.

Participant 2: They should make the service roads one way. I'm so tired of people from out of state coming at me and thinking it is one way. It is a safety issue.

Participant 1: Nothing to add.

Participant 6: The acceleration and deceleration lanes, that five inch white stripe, to me that is an "invisible wall." I want to see more policing of that line. Right here in Temple I see people crossing that invisible wall a hundred times a day. If they controlled the traffic going through here, it would be twice as good. As far as fixing financial problem.... It's going to take a lot of solutions.

Participant 5: Another problem is our government in Austin with the "bicameral" legislature. They need to meet more often to solve traffic problems.

Participant 4: But don't you remember we had one of the best highway systems 20 to 25 years ago? When you let stuff lag behind that is what happens. People are not doing what they are supposed to be doing. People have to be accountable. What's the governor doing?

#### **April 29, 2010, Gainesville, TX**

##### Use of I-35

Participant 6: I have noticed recently that there is not a lot of room. I almost hit two 18-wheelers on my last two trips. I have noticed this very recently.

Moderator: Does this vary by the time of day?

Participant 6: I don't really remember.

Participant 2: With vehicles getting bigger, I-35 seems to be narrower. It scares me. In the older parts of the road and near the entrances, it seems very narrow.

Participant 2: There is a crook on the on-ramp and if you are going to get up to speed in order to merge, you may lose control of your vehicle. You can't "look and crook."

Participant 3: From here to Ft. Worth (I drive there every morning and evening) it is pretty good. However, where it comes together at 35E it gets narrow there at the bridge.

Participant 6: A lot of this has to do with the vehicle. I have a 4 cylinder so some of my problems may be that I don't have the "gusto."

Participant 7: I travel just about the whole length of I-35. I used to live in Laredo. From Denton to Gainesville is usually not that bad but I have seen it pretty crowded. Denton to north of 820 is tolerable but other than that I would rather not go through Ft. Worth. I used to live in New Braunfels and would drive into Denton and would wait until 8 or 9 to leave Denton so as to avoid traffic along the I-35 corridor. I know it needs to be widened and it kills me thinking about what they will need to do to get that done.

Participant 2: It's congested all the time... even at 1:30 in the afternoon.

Participant 7: I have to allow 30 minutes to go 7 miles.

Participant 3: Friday nights are horrible at the bridge.

Participant 2: Yeah I have to allow an hour and a half to get to Dallas.

Participant 7: It is almost not worth having Dallas people come up here for 7 o'clock events because they can't get here.

Participant 2: And you can't u-turn to go north in some areas.

Participant 4: I've traveled for many years around Sanger and I used to live in California. I moved back here around 1992 and it was overwhelming coming back because traffic was not this congested when I left. And I always thought Texans were polite but now everyone is so rude...they are a lot nicer in California. I travel back and forth to Carrollton through Dallas and it is bad between Dallas and Lewisville. When I was working, if I did not get up and leave early, I was in trouble. Since the casinos have come up it is now crowded on the freeways during the weekends. We make trips back and forth to Austin to see our sons and that is a nightmare. We just made a trip there and it was stop and go on a weekend and there were no wrecks. It is normally about a three hour trip.

Participant 3: Austin has got to have the worst traffic in Texas. I would rather drive in Houston.



Participant 1: The times that I travel, what I notice is that it is not as congested. I travel at around 7:30 from Denton to Gainesville and I leave after 4:30. You can see more traffic but it is not to the point that you can't keep moving.

Moderator: But you are making a reverse commute, right?

Participant 1: Yes, and I live before 288 so I skip a lot of the congestion. It is horrible getting caught in Ft. Worth. And Lewisville to Dallas is very dangerous. The lanes are very narrow and there are bumps all in the road. It doesn't seem well maintained... especially after the last big snow.

Participant 2: The new Mixmaster around 635 is horrible, very narrow, and it is new.

Participant 3: Yeah it gets pretty rough there.

Participant 7: Right there where 12 splits off.

Participant 1: The signage is very important. I missed the exit a while back.

Participant 3: It's tough to identify right and left exits. You don't know what side of the road the exits will be on.

Participant 2: And signs don't say where you are going once you exit.

Moderator: So what are the biggest problems?

Participant 2: On and off ramps and signage.

Participant 3: Yes, signage is bad.

Participant 4: We have to keep in mind that growth is not going to stop. Look at Denton.

Participant 6: The mindset of how people drive doesn't change depending on the size of the road. Trucks, for example, just keep barreling through regardless of the roadway. I have a CDL and I know they are not all bad but it is a concern. I have not seen a lot of improvements in the past 20 years.

Participant 7: I have to admit that I see a lot of improvements around New Braunfels. I didn't think they would ever finish that but when they did it made all the difference.

Participant 6: Yeah but when you make improvements you have to keep up with them. You have to stay on top of improvements. Not necessarily on a yearly basis but they need to be updated on some type of basis.

Moderator: Do you mean maintained or expanded?

Participant 6: Both.

Participant 2: Where the factories have died out it is not so bad, but then others go up and then there is a need there.

Moderator: So are you saying I-35 should have already been expanded?

All: Yes.

Participant 6: You can see the connections happening with Oklahoma.

Participant 8: I travel every weekend (10K miles since January) on I-35 and it needs to be widened but it has been a long process. I don't have any trouble between here and Dallas because I know the times of day when traffic is going to be bad and up here it is still not bad, but that is because I know the times.

Participant 6: But you are working on a broken system...you should not have to schedule around a broken system.

Moderator: Now you, Participant 3, commute through Ft. Worth, right?

Participant 3: Yes. I leave at 4:30 in the morning, get through Ft. Worth and power nap at a rest stop. But I leave right at 5 to get back home. I-35 at 820 is the most irritating because it is two lanes and there is plenty of shoulder room for another lane.

Participant 7: I've had problems between Dallas and Denton on Sunday.

Moderator: Do any of you carpool?

Participant 8: We (Participants 8 and 1) do when we can.

(No others.)

Moderator: Would carpooling help?

Participant 7: A lot of people's schedules don't allow it.

Participant 2: Especially for the casino employees. A lot live in Arlington and they have a lot of variability in schedules.

Participant 7: And I don't know anyone who teaches when I teach.

Moderator: What about other modes?

Participant 8: There has been talk about getting a rail in Corinth but they (Corinth) didn't buy into it.

Participant 7: And I think it is a great idea but would not work for me.

Participant 2: I take the DART bus to Las Colinas I and love it.

Moderator: Would you take rail to Austin?

Participants 4 and 5: Oh, yes. But I had transit growing up, and I don't know why we don't have it here.

Moderator: If there was transit in the area would it alleviate some of the congestion around here?

Participants 4 and 5: Definitely.

Participant 7: A commuter rail from Dallas to Denton would be nice because I could go to events in the DFW area that I don't go to now because I don't want to get on I-35. However, it would not benefit my commute.

Participant 6: You brought up rail...we used it all the time in DC but the important aspect of it is when does it run? Will it have varying routes? Is it just evening/morning or is it going to run throughout the day with varying routes? Something like in DC would help and people would use it.

Participant 2: It would have to run four times... "school time" and "work time."

Moderator: So is everything getting worse?

All: Yes.

Participant 7: The University of North Texas (UNT) bus service is starting to get a lot better because of their improvements. When they first started doing the shuttle bus, where I lived 6 blocks from campus, they could not get enough buses on that route. They were always like sardine cans. Now they have enough buses. But what they have done is make those buses express buses. You can't just get on the bus and ride down and get off. You have to get on your specific route because the buses don't make all of the stops.

Participant 2: I don't think improving other alternate routes is going to help I-35. People are set in their ways. It might help through traffic, though.

Participant 7: I think improving certain routes, like 289, would take pressure off of 75.

(Moderator passes out the handout.)

Participant 7: West Texas is looking better and better.

Moderator: Look at the increases in population through 2035....it will increase congestion.....looking at traffic volumes....looking at trucks....

Participant 7: That is the funny thing about 35...at night it is all trucks.

Moderator: Looking at the LOS maps, these include current projects...

Participant 6: You're kidding...

Participant 8: The Denton mayor was telling people up here that the traffic was coming five years ago...now look at it. As soon as you hit 380 in Denton you used to be able to just go through with no problem, but now it doesn't ease up until Sanger.

Participant 5: I travel 35 at night and there are a lot of trucks there running me over. I have to drive 75 or 80 to keep ahead of them.

Participant 6: That is one of my concerns...ramps are not adjusted to the speed that is required to merge, especially with the trucks on the highway.

Participant 7: There is not enough time to get up to speed and merge. We need longer on-ramps and you need to be able to cruise at that speed until you find an opening.

Participant 2: If you are leaving the TA coming to Gainesville it is a bad on-ramp. It does this... (gestures).

Participant 1: I was scared when I transferred cities because I was shocked at the on-ramps. The exit at UNT, right after the bridge, there is a blind spot where the fence is and the visibility is very poor getting on.

Participant 4: It is terrible in Denton and it has been that way for years. I guess there are too many things that have to take place there. Every on-ramp from UNT stadium on is very dangerous. If you have a truck coming in the slow lane they have almost run me off the road to keep from hitting merging traffic. It is bad between Denton and Corinth.

Participant 2: There is a long ramp to come down here in Gainesville and people pile up on there and it is totally blind. It is dangerous with the trucks being there.

Participant 5: We need to look at the accidents that have occurred and why they have occurred in order to fix the situation.

Moderator: So what are we going to do?

Participant 7: Give really good subsidies for smart cars and get people into smaller vehicles. This will create more room.

Participant 2: And they can't go fast...I like that idea.

Participant 5: But then it will be like Austin where they just sit still.

Participant 4: I like the double deck in Austin. My hat's off to them on that and the ramps are better there.

Participant 5: The new loops and toll roads in that area are good, too.

Participant 6: My problem is when does a toll road quit being a toll road? That could be one of the solutions but I can't believe that we would never have something paid off.

Moderator: So if you had a toll road where would it be and who would use it?

Participant 2: I would never use it.

Participant 7: I probably would.

Participant 4: I read that a while back, they were going to build a toll road from Plano to Denton but I don't know what's happened with that.

Participant 6: I guess that you could make I-35 a toll road or take land and make a new toll road. But I don't think there is enough room to expand in Denton and you couldn't do it in Lewisville either.

Participant 3: So wouldn't it be easier to build up, like a double-decker (DD) rather than out?

Participants 4, 5, and 6 like this idea.

Participant 4: And there needs to be four lanes on each side all the way to Carrollton.

Participant 3: Or maybe south of Denton.

Participant 6: If this is what is projected (referring to handout) then whoever is the architect on the roadway needs to build into their plan something for a DD.

(Moderator discusses metropolitan planning organizations (MPOs) and planning.)

Participant 3: Okay, that makes perfect sense...they haven't committed a lot of money.

Participant 7: I thought there was going to be decking somewhere along through Denton?

Moderator: So you all like the idea of DD?

All: Yes.

Participant 7: Because of the land. You would not have to take any of it.

Participant 3: Semis could be on top and commuters on the bottom.

Moderator: So how would access work on this?

Participant 2: If you are going to expand other roads it will be like loops coming off the DD.

Participant 6: You don't have the same access. You should have to go farther to get off. It is a fast lane to get through the territory. I have seen these in Jersey and with some of these fast toll lanes, they actually have their own service stations on the facility itself.

Participant 7: Like the Kansas turnpike.

Participant 4: Another thing they need to do if they expand is keep truckers out of the inside lanes like in Austin. I don't see anything wrong with having a lane for the trucks.

Participant 8: You talk about needing longer merge lanes, but people don't stay behind those solid white lanes. You have to drive defensively.

Participant 7: If you have enough lane, where you can judge the length and get up to speed that is a big improvement.

Participant 6: These truckers have to pick up a lot of speed to make it up these hills and there are certain things they have to do to maintain speed.

Moderator: Well what about a DD for trucks only?

Participant 7: No.

Participant 3: Trucks are the least of our problems. Room on the roadway, speed and signage are the biggest problems. A lot of the problem is people always being late and driving like idiots. I used to do that when I was younger.

Participant 5: I lived in Denton for 25 years and was active with the city and they were stubborn about their roadways. When loop 288 came along, they didn't think they were going to have problems with trucks on there but they were wrong.

Moderator: So Participant 5 mentioned the 130 facility in Austin...is it worth it to think about something like that for 35...a different facility?

Participant 5: One of our sons had to get on I-35 before they had 130, and he loves it (130). He says it does not cost that much and it gives people a choice.

Moderator: Well I'm trying to get at the bypass idea....talks about Austin toll roads...130 not used because it is of little value to commuters....

Participant 3: Is that because it is so far out of the way?

Moderator: About nine miles...

Participant 3: I would take it. I would take something like that to avoid Ft. Worth.

Participant 7: I've tried taking 20 as an alternative and the time taken going around is equal to the time you lose in congestion.

Participant 2: I don't like toll roads. I had to take one once when I missed a sign.

Participant 3: But the toll roads are so much better maintained.

Participant 2: Yeah because money is coming out of your pocket daily.

Participant 6: They continue to maintain it but at what point is a toll road paid off?

Moderator: So does everyone like the DD idea?

Participant 1: Depends on where the exits would be.

Moderator: But a parallel facility is not really a good idea?

Participant 8: It would be nice if there was room, and I don't think there is. We have already had the land taking argument here but if there was room I would pay to drive a toll road like that. When they built George Bush, I loved that. A DD would be great too. Widening lanes would be great as well. Adding two more lanes, even if they were tolled, would be fine.

Moderator: So you want to add to the existing facility...either up or down or out?

Yes.

Participant 6: But everyone agrees that we don't want land taken like the Trans Texas Corridor was going to do.

Moderator: How do transportation improvements get paid for?

Participant 2: Federal grants, motor vehicle fuel taxes.

Participant 6: Some comes from the federal government.

Participant 1: I know that about  $\frac{3}{4}$  of fuel taxes go to transportation and the rest goes to education.

(Moderator talks about fuel taxes.)

Nobody knows when taxes were last raised.

(Moderator discusses fuel efficiency... increases in VMT relative to decrease in fuel tax revenues.)

Participant 6: I would like to see some sort of analysis and comparison between the sort of improvements we are talking about. What does a DD cost relative to other types of improvements?

(Moderator discusses road costs.)

Participant 2: I say we use convicts to construct the roadways. They are cheaper.

Participant 8: But then you have to pay someone to watch the convicts.

Participant 3: Yeah, we don't need more people watching other people work.

Moderator: So regardless of the solution we implement, how do you pay for it? (Discusses bonding.)

Participant 8: Well, like you said, we have more fuel efficient vehicles, which are driving down fuel revenues.

Participant 6: But our population growth should be offsetting that. We have some of the fastest growing cities in the nation.

(Moderator discusses increases in construction costs.)

Participant 6: If we expand 35, won't that increase truck traffic? Wasn't that the point of the TTC...to increase truck traffic?

Participant 8: I understand that at some point we are going to have to increase fuel tax revenues. Some areas have a road improvement tax. I have seen "privilege tax" for vehicle ownership and we have a lot of people moving into the state. We need to look at a tax on new vehicles. I paid up to \$800 in West Virginia.

Participant 2: My husband works on cars, and we buy and sell a lot of them, and that would kill our business.

Participant 8: We have a lot of students in the area, and what about them?

Participant 6: Give exclusion.

Participant ?: But how many of them come to school with a car?

Participant 6: When I went to Florida, I got an exclusion.

Participant ?: There are ways of getting exclusions.

(Discussion of registration process and how a new vehicle tax would work...couldn't follow...even after listening to tape.)

Moderator: Discusses toll road financing....why they are not free after a while. So who likes tolling?

Most participants like tolling.

Participant 7: I don't like having my credit cards charged when they are already maxed out.

Participant 2: I would not use toll facilities.

Participant 5: We have to be thinking about growth and new ways of addressing problems. Fixing traffic issues and providing transit options will be a boon for urban areas.

Participant 4: We usually shop in Gainesville. They have everything we need.

Moderator: So if something does not happen to fix congestion then the economy of these cities will be affected?

Participant 5: Yes.

Participant 7: It is weird that people drive 40 miles to work and pass each other on the highway.



Moderator: Should there be policies encouraging people living close to work?

No.

Participant 2: We are regulated enough. The new school came in and 51 is really populated now so now we have people passing us going 70 when there is a tractor in front of us. This is not country anymore and those roads are dangerous with drop-offs in ditches and people flying around here at 90 mph.

#### Closing Comments

Participant 7: Public transportation should be looked at as a solution. Trains are very cost effective. Even improved bus service, such as commuter buses, would be good. The thing is we keep looking at the I-35 corridor but it is only a part; it won't solve all the problems. I would like to see more transit.

Participant 6: I agree that some sort of transit along with expansion of I-35 is needed. I also like the fee on new registrations.

Participant 5: I have lived here a while and Denton has not planned for this growth and now we're sitting here in a panic because responsibility has not been taken. They are putting a Sam's up here on I-35 and I don't know how that is going to work.

Participant 2: Yeah residential areas being built like they are is a problem.

Participant 4: Public transportation, even from Denton to Dallas with maybe stops in between, can be very expensive. It is the same problem but we need more of that. I also think that we need a toll road. From Oklahoma to wherever. When the TTC thing came along I did not like taking people's businesses and property but what are you going to do? I understand people's land concerns but something needs to be done about 35.

Participant 3: Until today, I never considered transit an option but for in-town people (people not going to work in Gainesville), but for Ft. Worth and Denton people it would probably be great. If I had a job where I could use a park and ride, I would use it.

Moderator: What about getting to use a toll facility for free as a carpool? Is that an incentive?

Participant 3: It just depends on the work schedule.

Participant 2: Residential areas are a problem. I might be alright with tolls if I didn't have to take it. Transit could work if it goes where people need it.

Participant 8: You are going to have to get the money some place and it is going to require taxes. I am not opposed to tollways, or just painting lanes. I am not opposed to new bonds, new taxes. Something needs to be done. Just do it.

Participant 7: It will be our money anyway.

Participant 1: I am definitely for public transportation because it will save everyone car maintenance and expenditures and would reduce congestion and save lives. The only thing against that is that you have a problem once you reach your destination and you don't have travel alternatives. I also think that some sort of agreement with TxDOT and local government about addressing back roads is needed because some of those are even worse because of the traffic. There also needs to be public education about not needing to use 35 all the time. I might use a toll road but I would not use it every day.

## BUSINESS LISTENING SESSION RESULTS

Texas Transportation Institute

# Interstate 35 Citizens' Advisory Committee Public Outreach:

## Business Listening Session Results

Work performed under TxDOT RMC 0-6581, Task 11

Tina Geiselbrecht and Richard Baker  
October 15, 2010



## TABLE OF CONTENTS

|  | <b>Page</b> |
|--|-------------|
| <b>List of Figures and Tables</b>                              | <b>277</b>  |
| <b>Executive Summary</b>                                       | <b>278</b>  |
| Key Observations   | 279         |
| <b>Introduction</b>  | <b>281</b>  |
| <b>Business Listening Sessions</b>                             | <b>281</b>  |
| Segment Three  | 281         |
| Segment One/Two  | 283         |
| Segment Two  | 285         |
| Segment Four   | 288         |
| Segment Three/Four   | 289         |
| <b>Conclusions</b>   | <b>292</b>  |
| <b>Appendix A. Business Listening Session Discussion Guide</b> | <b>295</b>  |
| <b>Appendix B. Business Listening Session Notes</b>            | <b>299</b>  |
| Austin Business Listening Session: March 30, 2010              | 299         |
| Dallas Business Listening Session: April 14, 2010              | 305         |
| Waco Business Listening Session: September 30, 2010            | 315         |
| Laredo Business Listening Session: April 6, 2010               | 327         |
| San Antonio Business Listening Session: April 30, 2010         | 331         |

## LIST OF FIGURES AND TABLES

|  | <b>Page</b> |
|--|-------------|
| Figure ES 1: I-35 Corridor Segments .....          | 278         |
| Table ES 1. Focus Group Session Distribution. .... | 280         |

## Executive Summary

The Interstate 35 (I-35) Citizens' Advisory Committee is charged to “study the impact of corridor-wide issues, including economic, political, societal, demographic, population trends, use of existing/new/upgraded facilities, multimodal solutions and finance options; make recommendations on corridor planning, development and public involvement; and enhance participation and input between the Texas Department of Transportation (TxDOT) and affected communities, governmental entities and interested parties.” As part of that effort the Texas Transportation Institute (TTI) was tasked with gathering public input of current and future needs of the I-35 corridor. To achieve this goal TTI conducted 12 focus groups and/or listening sessions throughout the corridor. Focus groups and listening sessions were conducted in each of the four segments of corridor (Figure ES 1). Focus groups with the general public were conducted in rural and urban areas and listening sessions with the business community were conducted in the urban areas. Table ES 1 below indicates the dates and locations of these sessions.

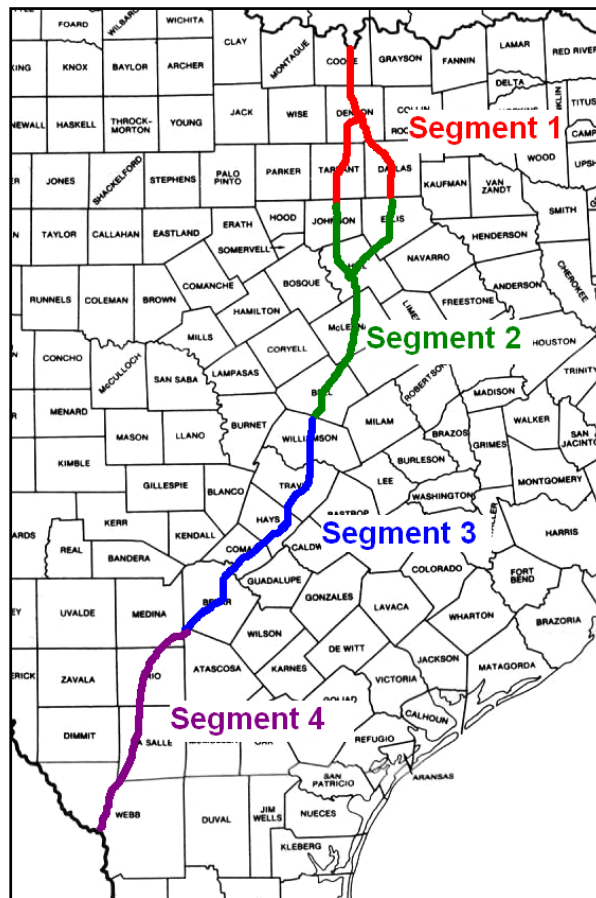


Figure ES 1: I-35 Corridor Segments

## Key Observations

Unlike the focus groups with the general public, the business listening sessions differed more from each other. In the Dallas/Ft. Worth area, the listening session indicated that this area had already defined their needs to meet the future demands in the I-35 corridor. They felt that primarily TxDOT and to a lesser extent Federal officials were a roadblock to implementation. They were very supportive of being in charge of their own destiny. They also expressed concerns over future funding and its inadequacy in meeting the needs. They indicated that comprehensive development agreements and involving the private sector were the only mechanisms to get the proposed improvements financed.

In the Austin area the business listening session favored better utilization of existing infrastructure. Many expressed dissatisfaction in the perceived under utilization of State Highway (SH) 130. To this group, moving trucks from the downtown core was a huge issue. Moreover, the group did not believe that meaningful improvements could be made on I-35. Instead they preferred a more system-wide approach where alternate corridors should be improved. However, they did support adding managed lanes on I-35.

The segment two business listening session (Hillsboro, Waco, Temple and Killen areas), noted that the primary issues with regard to I-35 were related to capacity. This group did not feel that this segment of I-35 had enough lanes or enough access to accommodate the volume of traffic utilizing the facility on a daily basis. It was also noted by this group that I-35 is the primary artery for all travelers in their particular area, and that a lack of a viable alternative arterial system creates significant congestion issues as local residents must use the already crowded interstate to make relatively short distance trips.

The segment four listening session (Laredo) focused on making local improvements at bottleneck areas such as Loop 20. This group felt that I-35 could be expanded because there is sufficient right-of-way. They were opposed to a new facility. One of the primary concerns was facilitating trade with Mexico.

A listening session held in San Antonio yielded comments related to both segments three and four. The biggest concern for this group was eliminating bottlenecks by correcting what they saw as design flaws. For instance, they felt that many ramps were outdated and even new ones that were constructed were inadequate as soon as they were operational. Interestingly, this group also felt as if the “area was its own worst enemy.” Several people indicated that many different agencies are tasked with transportation planning and none of them are working in concert with one another. They felt that this issue would have to be resolved before any meaningful decisions could be made.

Like the general public focus groups, the business listening session participants felt that more traveler information would be useful to the public. This would allow them to make better informed decisions about both routes and modes. Also, like the general public, they saw a need to make what they considered short-term solutions first such as improving ramp configurations. With the exception of the Austin session none of the other groups mentioned advances in

technology and alternative work schedules as viable solutions to improving congestion, although this was mentioned in every general public focus group.

There was more of an understanding among the business listening sessions about transportation finance and funding than what was observed in the general public sessions. There was a strong call to end diversions of gas tax revenues. Most felt that the easy fix for additional funding was to raise and/or index the gas tax but they also did not perceive this as very likely. There was some support for a local option tax either on gas or general sales. The Metroplex participants felt very strongly that private sector participation was necessary to get improvements implemented.

**Table ES 1. Focus Group Session Distribution.**

|                       |                             | Location   | Urban/Rural                       | Number of Participants |   |
|-----------------------|-----------------------------|--|-----------------------------------|------------------------|---|
|                       |                             |  |                                   |                        |   |
| General Public Groups | Segment One                 | Dallas – TTI Dallas Office                             | Urban                             | 6                      |   |
|                       |                             | Fort Worth – Tarrant County Agri-Life Extension Office | Urban                             | 7                      |   |
|                       |                             | Gainesville – Cooke County Public Library              | Rural                             | 8                      |   |
|                       | Segment Two                 | Waxahachie – Ellis County Extension Office             | Rural                             | 6                      |   |
|                       |                             | Waco/Temple/Belton                                     | Urban                             | 6                      |   |
|                       | Segment Three               | Jarrell – Jarrell City Council Chambers                | Rural                             | 12                     |   |
|                       |                             | Austin – TTI Austin Office                             | Urban                             | 10                     |   |
|                       | Segment Four                | Laredo, Laredo Development Foundation                  | Urban                             | 10                     |   |
|                       | Business Listening Sessions | Segment One  | Dallas/Ft. Worth – NCTCOG offices |                        | 8 |
|                       |                             | Segment Two  | Waco, McLennan County Courthouse  |                        | 6 |
| Segment Three         |                             | Greater Austin Chamber of Commerce                     |                                   | 13                     |   |
|                       |                             | San Antonio Chamber of Commerce                        |                                   | 13                     |   |
| Segment Four          |                             | Laredo Chamber of Commerce                             |                                   | 9                      |   |



## INTRODUCTION

The Interstate 35 (I-35) Citizens' Advisory Committee was formed by the Texas Transportation Commission to develop alternatives for meeting the current and future needs of the I-35 corridor. The Texas Transportation Institute conducted focus groups with the general public and listening sessions with members of the business community to assess the attitudes and opinions of these important stakeholders. This report documents the results of four listening sessions that were conducted with the business community, one in each segment of the corridor. A companion report, *Interstate 35 Citizens' Advisory Committee Public Outreach: Focus Group Results*, documents the recruitment efforts for both the general public focus groups and the business listening sessions. For the most part, recruitment for the business listening sessions was accomplished with the help of local chambers of commerce. In some instances, such as the Greater Austin Chamber of Commerce and the North Central Council of Governments, these groups actually screened participants for the session.

The listening sessions were comprised of individuals that had businesses within the corridor or businesses that regularly use I-35 for transporting their goods. Two schools in the I-35 corridor were also represented in the sessions.

## BUSINESS LISTENING SESSIONS

### Segment Three

This group was comprised of individuals that represented:

- a major hospital,
- a major university,
- a company utilizing heavy equipment,
- a housing developer,
- a major grocery store chain, a service company, and
- other businesses in the Austin area.

Almost immediately conversation turned to the issue of trucks on I-35. The representative from the grocery store indicated that they carry approximately 400,000–500,000 truck loads per year on I-35. Additionally, they have large distribution facilities along the I-35 corridor. A person representing the Greater Austin Chamber of Commerce indicated that the chamber is exploring ways to offer incentives to trucks to move off of I-35 in the peak period. Others also mentioned that the Texas Transportation Commission has asked TxDOT to study options related to this issue.

While there was general agreement that the volume of trucks on I-35 impedes the flow of traffic, a couple of people did not believe that removing truck traffic would make a significant difference in congestion. They felt that any additional space that was freed would immediately

be filled with additional cars. Several people were interested in a report that documented the volume of traffic on SH 130. They were also interested in knowing the origins and destinations of this traffic in an effort to determine what is “local” traffic and what is “through” traffic. All participants agreed that there should be many solutions explored.

With regard to truck traffic on I-35 and truck use of SH 130, one participant inquired of the grocery store representative why their company did not use the area toll facilities. The grocery store representative indicated that they had conducted their own study of the facility and had concluded that it would not be cost effective to use SH 130 given the total number of loads they move. This person did state; however, that their company would be willing to revisit the issue should incentives such as lower truck tolls be offered on SH 130.

One participant pointed out that in many cases traffic congestion is now seen as a cost of doing business yet actual road user costs are not figured into the calculus of people’s and business’ decision making.

The moderator asked if any studies had been conducted on where employees live. One business had done this and indicated that most of their employees live to the northwest. Subsequently they have continued to move their offices out of the central Austin area. The representative from the university presented a study they had performed that showed that more than 16,000 students reside outside of the city in which the university is located. That means they are commuting on I-35. This university also has a campus in Round Rock, and faculty must commute from San Marcos to Round Rock. To address the congestion issue, the provost has added a stipend to their mileage reimbursement to allow them to take SH 130 to avoid congestion on I-35.

The company that moves heavy equipment indicated that they would prefer to use SH 130; however, their gross vehicle weights prohibit them from doing so. This generated a lot of discussion about the bond indentures associated with SH 130 and what they allow and disallow. Many suggested that they be revisited.

Overwhelmingly the group felt that TxDOT should be taking a more system-wide approach. They also felt that the department should be working more closely with cities and counties along the SH 130 corridor to plan and coordinate development so that SH 130 does not end up being like I-35. Several people mentioned the commercial and housing developments that have occurred in Buda and Kyle and how many extra trips on I-35 these establishments generate.

There was some discussion of rail options but most did not think this was a viable option for relieving congestion on I-35. Many of the businesses represented either could not use rail or currently used rail but only in a very limited capacity. However, most people felt strongly this was still an option that should be explored. Again, they wanted all solutions considered.

Similar to the general public focus groups, this listening session suggested short-term and long-term solutions. One of the most supported suggestions was providing traveler information. The use of changeable message signs to inform the public about traffic conditions and travel times, so they can make better decisions about routes and modes, was a popular suggestion.

Other short-term solutions included offering incentives to divert truck traffic off of I-35. They also suggested allowing longer combination vehicles (LCV) on SH 130, as this would provide an incentive to trucking companies to use the toll road. The participants also thought the department should immediately start working with counties and other entities to plan for and direct growth.

Longer term solutions included adding managed high occupancy vehicle (HOV) lanes to I-35. One participant noted that an HOV facility running into the city from the south, serving Kyle area residents, might be beneficial given that that area supplies a significant amount of area workers and is fairly inexpensive to live in. The group suggested these lanes be priced so as to provide a congestion free alternative. Participants also recognized the need to provide better ramp configurations and acceleration/deceleration lanes.

There was considerable discussion and some disagreement about expanding I-35. Some participants believed that only looking at I-35 would be a mistake, and that for the Austin area there needs to be a more system-wide evaluation that includes other facilities such as Mopac, in particular. It was also noted that I-35 is currently “maxed out” and that it would be a better use of funding to look at developing other alternatives. It was also recommended that there be a focus on maximizing utilization of SH 130.

In terms of paying for transportation solutions, the preferred method was raising the gas tax. Raising and even indexing the gas tax was seen as viable solutions to not only funding transportation programs but achieving other transportation related policy goals such as emissions reduction as well. However, there was much skepticism about the prospects of actually raising the gas tax. The diversion of fuel tax revenues to non-transportation uses was also cited as a major problem. One of the participants noted that due to the growing market for hybrids and other highly fuel efficient vehicles that the fuel tax would not be sustainable. Vehicle miles traveled (VMT) fees were mentioned as a potential solution that should be examined.

## **Segment One/Two**

This group was comprised of:

- a “geo-tech” company,
- two county government agencies,
- a printing company,
- two real estate development companies,
- an area university, and
- a chamber of commerce representative.

Participants in this session noted that construction in the Dallas-Ft. Worth (DFW) area along I-35 has created significant problems but that once completed the newer facilities have made commutes easier. Access continues to be an issue with many of the representatives, as it was noted that the placement of u-turns and exit/entrance points can enable or hinder access to

local business depending on where they are placed. Some participants related their experiences in dealing with various TxDOT offices in the area with regards to addressing access issues with mixed results. There was frustration expressed by one participant with regard to the long response time for an area TxDOT office to provide a permit for what was perceived, by the participant, as being a simple and innocuous job.

Group participants agreed that their region, the DFW area, is growing, will continue to grow, and is a strong economic engine nationally. However, congestion was seen as hurting the local economy in many ways. The chamber of commerce representative noted that lately they have had difficulty attracting new businesses to the area. In fact, when hosting potential businesses they often offer a helicopter tour as opposed to a driving tour. He stated the reason for doing this was entirely because of traffic congestion.

“Maximizing throughput” was seen as one of the best solutions to area congestion. Participants favored expansion of general purpose facilities but most were not convinced that that would happen and that most new capacity in the region would be in the form of managed lanes.

There was also discussion about utilizing transit to address area congestion. Buses were the preferred transit choice given the expensive nature of rail, but support for transit development as a means of addressing area congestion was by no means unanimous. Many participants stated that it is simply cheaper to build roads and that area residents would much rather travel in their own vehicles to get where they need to go as opposed to having to rely on transit services. Chicago was cited as a good example of how multiple modes could be incorporated into an effective and highly utilized transportation network, but it was quickly pointed out that there were numerous differences between the Chicago area and the DFW region both in terms culture and development patterns.

The area university representative noted that their institution had made significant investments in their campus transit system that were working rather well. They have developed a rail system and have invested in many new buses that run on express routes. They also strongly discourage students from bringing a car to campus.

There was a substantial amount of discussion with regard to project delivery methods and, in particular, the role of comprehensive development agreements in addressing regional mobility needs. Most of the participants in attendance were clearly in favor of utilizing private equity for infrastructure development but felt stymied by TxDOT administrators as well as federal transportation officials. Issues that were raised specifically included the perceived inefficiency of required environmental assessments and the necessity of business impacts assessments. There was a perception among some participants that these requirements were a means for TxDOT and federal officials to “stick their nose” into local development and usurp local authority.

One participant noted that the steps being taken in the DFW area with regard to developing priced facilities could be implemented all along the I-35 corridor to address many of the issues that triggered the initiation of these outreach efforts. That sentiment was echoed by other participants.

The lack of funding for transportation development was seen as a major issue, with several participants noting that these discussions would not be necessary if there was sufficient funding to meet the state's needs. Raising and indexing the fuel tax were mentioned and generally supported by the group participants but most did not believe that this would occur within the foreseeable future. The potential political repercussions of a tax increase were cited as the major factors undermining a fuel tax increase but two participants noted that the lack of public knowledge about transportation funding and financing exacerbates the problem. The chamber representative noted that they often conduct a "Budget 101" workshop to help educate the public.

## **Segment Two**

This group was comprised of:

- a hospital representative
- a furniture and wall paneling manufacturer
- a laminate and counter top manufacturer
- a representative of local land owners
- a logistics firm

For this listening session's participants, one of the primary issues related to segment two of the I-35 corridor was an all around lack of access to the roadway itself. Access, for this group, was defined in terms of the number and placement of entrance and exit ramps along I-35 and the presence of frontage roads. The current facility, in the opinion of the participants, lacks an adequate number of entrance and exit ramps and is not supported by continuous frontage roads. As a result, whenever there are incidents on the I-35 facility, it is difficult, if not impossible, for drivers to exit the facility and bypass the incident itself or maneuver around congestion.

Compounding this lack of access is a lack of alternate routes within the segment. Most of those in attendance stated that there are not very many viable alternatives to I-35 for mid to long distance trips. As a result, a significant amount of volume on segment two is "local" traffic that would be better served taking routes other than I-35, if those routes existed or were viable. (In terms of viability, it was the opinion of several participants that existing alternate facilities, such as Loop 363 in the Temple area, could not adequately accommodate truck traffic and would be unable to handle increased volumes from vehicles using it as an alternative to I-35.) Participants expressed frustration that often they are aware of bad traffic conditions on I-35 but are unable to take alternate routes for their trips, and must either wait for congestion to subside before departing or simply deal with the congestion.

It was noted by several participants that the presence of better, real time traffic information would be beneficial, even if travelers are limited in their route options. Making better use of dynamic messaging signs or utilizing smart phone applications were mentioned as means of accomplishing this.

There were also concerns expressed with regard to the capacity of I-35 itself, particularly in the area north of Temple. Participants noted that the freeway is only four lanes (two in each direction) in this area, which can cause significant problems whenever there is an incident. It was also noted that local entities, especially the smaller cities north of Temple, do not have the resources available to handle incidents within that section of the corridor and still provide service to their own communities.

Three of the businesses present have significant truck operations in the I-35 corridor, and congestion (particularly on Fridays and through the weekend) can severely affect their ability to make shipments in the time required by their clients. These businesses stated that they do use tolled facilities on occasion and that their vehicles are equipped with TxTag. Participants also stated that congestion on I-35 is a problem for employees, especially those coming into work from the south. There were several anecdotes given during the session regarding employees who had been delayed on their way into work for several hours as a result of traffic. One participant stated that employees at their facility had developed an informal network to relay information on traffic conditions. Employees that are out on the road or are aware of traffic incidents will send a text message or e-mail their fellow employees, who will then relay the information to other employees who might be affected by the current road conditions.

In terms of addressing the major issues with I-35, and specifically segment two in the short term, the general consensus was that transportation entities need to better utilize various technology options with regard to relaying traffic information to travelers. It was noted by one participant that there are numerous smart phone applications that relay traffic information, and that these types of systems could be better utilized to allow travelers to plan routes so as to avoid congestion. It was also recommended that transportation entities make better use of existing dynamic message signs and install similar equipment to provide incident and construction related information to travelers, so that they can be better aware of current roadway conditions.

Unlike other sessions conducted in this research effort, participants in this session did not view restricting trucks from travel in the inside lane as an effective means of addressing truck related issues within the corridor. While participants did note that the large numbers of trucks on the facility is a concern for them as drivers, they did not feel that the restrictions implemented in the northern end of segment three were all that effective. It was noted that in principal such restrictions could work, but that passenger vehicles often drive in a manner that limits the effectiveness of truck lane restrictions. For example, several participants observed that often passenger vehicles will drive at or below the speed limit in the far left lane, causing backups in the lane behind them. Often, there are large numbers of trucks in the middle lane, creating a situation that many in attendance did not feel was safe, as these large vehicles cannot see the small vehicles in the lane next to them.

The primary long term solutions for I-35 and segment two were related to capacity enhancement. Most of the attendees did not feel that I-35 has enough lanes to accommodate the volumes of traffic the facility sees on a daily basis, particularly through the Waco to Temple area. It was recommended that that particular section of the corridor be expanded to a total of 8 lanes, four running in each direction. This sentiment was reinforced by the information related to average volumes on I-35 for segment two that was provided midway through the listening

session. Many participants had underestimated the typical volume of traffic on I-35 in their area, and the information provided underscored their assertion that additional capacity is needed.

It was also recommended by the session participants that parallel and other alternative routes to I-35 be developed. Participants noted that there are currently not many alternate routes for area residents and businesses wishing to travel north and south through the area. One participant stated that less expansion on I-35 would be required if parallel and/or bypass routes, such as Loop 363 in Temple, could be expanded. It was also noted that a more developed arterial roadway system in the area would provide alternative route options for residents seeking to make shorter distance trips that might otherwise be taken on I-35. A recurring theme of this portion of the discussions was that capacity on I-35 should be reserved for true through traffic to the greatest extent possible. As such, there was also support for the development of express lanes that would allow non-local traffic to pass through area urban centers without the need to mix with local traffic. HOV lanes were not seen as viable given that the cities in the segment lack centralized employment centers.

An important difference to note between this session and other sessions is that there was little support for developing “double deck” facilities that might separate local traffic from through traffic. While “double decking” I-35 was initially of interest to the group, many in attendance stated that there are a multitude of problems with the double deck facility that runs through the Central Austin area. After this discussion, participants became less supportive of a similar structure being erected to address traffic issues in their area.

Rail development, in terms of both freight and passenger rail, was not viewed as a very viable alternative to use of I-35 in either the short or the long term. The businesses representatives noted that they would be unable to relocate facilities in order to make adequate use of rail for freight movement. Furthermore, participants did not feel that rail was a viable option for removing passenger traffic from I-35, noting that the culture in the state is more car-oriented. Participants did not feel that rail, and similarly transit, offered enough flexibility in terms of actually getting to desired locations to merit exploration as a possible means of alleviating I-35 traffic volumes.

In terms of paying for desired enhancements to I-35, there was a general desire among participants to “stop sending money to Washington.” There was modest support for increasing the fuel tax provided that the increased revenues would go towards needed infrastructure enhancements. It was noted that if leaders could make a strong case that new revenues were being spent on Texas, and not going to other states or for uses other than transportation, that the public might support fee increases. However, participants did not believe that a fuel tax increase was likely to happen, stating that elected officials would not be up to the task. Tolling was viewed as a possible solution, but it was not the preferred solution.

There was less ambivalence toward TxDOT expressed in this group than other business listening sessions. None of the participants in this session indicated that they had any problems with local TxDOT officials and did not express any dissatisfaction with TxDOT in general. However, participants did note that TxDOT has credibility issues. At one point the moderator asked if participants would believe TxDOT if the agency said that revenues from a fuel tax

increase would go to pay for a specific project in their area, and the near universal answer was “no.”

#### **Segment Four**

The segment four focus group was attended by:

- a customs broker,
- a telecommunications company,
- an electrical cooperative,
- a real estate developer,
- an orchard owner, and
- three ranchers.

At the outset of the meeting the ranchers in attendance stated that they were participating so they could get assurances that the Trans Texas Corridor was not going to be constructed.

In terms of general issues with the segment, most of the participants stated that any problems encountered by their business occurred due to various design issues within Laredo or occurred within other segments of I-35 such as in Austin and Waco. The I-35/Loop 20 interchange was cited as a particularly problematic area in terms of causing local traffic problems.

While there was a general sense of agreement that congestion was becoming an issue in segment four and more specifically in Laredo, most participants stated that congestion was worse along other sections of I-35. The orchard owner noted that he made regular runs up and down the I-35 corridor and stated that Waco was starting to get very bad in terms of congestion. It was noted by another participant that the entire length of I-35 between San Antonio and Waco causes him trouble in his travels.

It was noted on several occasions that state and federal entities do not understand the importance of the I-35 corridor and in particular Segment Four as it relates to the international border with Mexico. This point was made by the customs brokerage representative as well as the real estate developer.

Road expansion in terms of more lanes and better access roads was cited as a potential solution to the area’s roadway troubles. In terms of road expansion along segment four, most of the participants did not see why expansion could not occur if it is needed, seeing as how the right-of-way for such expansions would be available. The customs broker noted that while congestion on I-35 and the general condition of I-35 did not much affect his business, his employer supported any expansion of the facility as a means of facilitating better trade.

The issue of developing new facilities was discussed but many of the participants stated that there would be significant right-of-way issues with that approach. The real estate developer



noted that current state laws discourage landowners from donating land for such projects due to the fact that land values go up along the facility but the owner often loses their agricultural exemption. This participant noted that a 10 to 20 year "locked-in," guaranteed value on land would help make landowners more willing to participate in the process.

Rail and transit development were viewed favorably by participants, but in general there was a strong belief that any problems in the area could be addressed by making better use of existing infrastructure such as medians, shoulders, and access roads.

Participants in the Segment Four listening session did not favor increasing fuel taxes in order to meet short-term and long-term needs. Toll roads and toll road revenues were mentioned as one possible solution by one of the ranching representatives but that solution did not appear to have much support among other participants. Raising vehicle inspection and registration fees were also recommended and at one point discussion turned toward using an EZ Tag-type system that would charge out of region drivers for use of the area roadway network. While there was some support for the idea of charging out of area drivers for use of the local roadway network it appears that the group did not feel that this solution would be workable.

Ending diversions was endorsed by this group as one possible means of addressing the state's transportation financing issues.

### **Segment Three/Four**

This listening session was attended by representatives of:

- a large construction firm,
- a used car dealer,
- two cities,
- a material distributor,
- a construction equipment manufacturer,
- a non-profit,
- two consulting firms,
- a transportation advocacy group,
- the area Regional Mobility Authority (RMA),
- a building supply store, and
- a regional mobility advocacy coalition.

At the outset of the meeting, the building supply chain representative indicated that his company ran approximately 80 trucks in the area.

There was general agreement by those in attendance that the San Antonio area was growing and would continue to grow. There was also general agreement that the problems faced by the region would continue to worsen if action was not taken to address them.

Congestion on I-35 for the businesses represented is an issue but it was expressed more in terms of the affect on their employees and less in terms of their business operations. Several participants, including the representative of the used car dealership, noted that their employees had substantial commute times. The used car dealer noted that commute times into San Antonio in the AM peak and out of San Antonio in the PM peak were the worst. This business had several locations, and the representative noted that employees making the reverse commute to their New Braunfels location did not have the same issue as their San Antonio based employees.

The representative of the construction equipment manufacturer did indicate that congestion can seriously affect their deliveries. This participant noted that delayed deliveries one day cause delays for the next day's deliveries, as their operations run on a shuttle-type system. The construction company representative also stated that congestion can interfere with their schedules. The business consulting representative noted that even though congestion does not affect his business directly, it does create a domino effect that affects his business as well as those he represents.

“Bottlenecking” was identified as one of the major problems along I-35, which was attributed to design issues. Poorly designed on- and off-ramps at Loop 1604 were highlighted as one example. The building supply representative noted that it is frustrating to see ramps, such as at US 183 and I-35, that just open and already appear to be too poorly designed to accommodate the current volumes, much less future volumes.

The lack of information with regard to traffic conditions was highlighted by several participants throughout the session. This was expressed in terms of a lack of information about traffic incidents, congestion, and alternate routes. A couple of representatives noted that they or other employees traveled on a regular basis into or through Austin, and that the lack of information about traffic conditions in Austin is a real problem since congestion can be very erratic. In response to this comment, the consulting representative noted that having information about congestion and incidents is not enough, because many drivers do not know enough about area roads to be able to take advantage of alternate routes and therefore avoid congestion. Better use of existing dynamic message signs and an AM station dedicated to relaying traffic conditions were recommended as means of providing travel information to drivers. The RMA representative stated that if drivers do not know they can save an hour and half by using SH 130 for \$5, then how is SH 130 a viable alternative? At a later point in the session, the building supply chain representative noted that technology is a much cheaper solution to area traffic problems than rail or new facilities, and that his employer was utilizing more GPS-based applications in their fleet to address various problems.

In response to the discussion regarding possible solutions to issues facing the I-35 corridor and Segments Three and Four, one of the city government representatives recommended two short-term fixes that he believed could be carried out without substantial investment. These included: better incident management, making more of an effort at informing the public about carpooling and park and ride opportunities.

Issues with regard to planning and coordination between various state and local entities recurred continually throughout the course of the session. It was noted on numerous occasions by numerous participants that there is a substantial number of governmental entities in the area that all seemed to be charged with the planning of various infrastructure, but that there appears to be little, if any, coordination. A “disconnect” between TxDOT and the various local entities was highlighted by one of the consulting representatives who went on to say that projects are often developed without having those who would benefit from the development on board from the beginning. The building supply chain representative noted that TxDOT has a bad habit of caving to political pressure and “shoehorning” on- and off-ramps into areas where they do not belong.

Rail was discussed a great deal as a possible solution to issues facing I-35. A city representative noted that the presence of an integrated transit system (that included rail, transit, and pedestrian facilities) in other areas of the world reduces the need for vehicles in those areas. However, other participants noted that funding is simply not available to carry out the development of such systems. A second point was made by the representative of the used car dealership that rail would most likely not help commuters very much because they would still have to find some means of getting them from the rail station to their place of employment. He also stated rail would not help their business because they had millions of dollars already tied into their location and would not abandon it to relocate closer to rail.

One of the city representatives in attendance noted that park and ride facilities were becoming a lot more crowded, and that people were starting to better coordinate carpooling and vanpooling efforts in the area. Incentives for carpooling and even high occupancy toll (HOT) lanes, assuming that HOVs rode for free, had some support among several participants. One of the consultants in the session noted that solutions such as these would help the area in the event that it went into non-attainment for air quality. However, in terms of actually implementing an HOV or HOT facility there was a belief that general purpose lanes could not be taken and would have to be incorporated as part of added capacity.

Another idea that was proposed with some support was having expanded rail services and an elevated highway for through traffic, similar to the facility located at Hildebrand. The construction company representative noted that doing a double-deck facility would probably solve a lot of problems but that it would be extremely expensive; perhaps even more than the Trans Texas Corridor was expected to cost.

A couple of participants pointed out the need to separate truck traffic from passenger vehicles. However, the ability to do so, they noted, would depend on the available right-of-way. One of the consultants in attendance stated that depending on available right-of-way, it would probably be best to go “up,” such as with a double deck facility, in the urban core, and also build “out” outside of downtown and central San Antonio. The RMA representative stated that expanding Loop 410 and/or Loop 1604 to accommodate more traffic could help divert through traffic and the regional mobility advocacy coalition representative agreed with this recommendation, noting that Loop 410 was insufficient to accommodate trucks. While not stated directly in response to this line of discussion, the construction equipment manufacturing representative had previously stated that his company would use alternate facilities and even SH 130 if it was economically viable. However, they currently have to make a lot of “through” stops in metro areas, and alternate facilities to I-35 would not help them.

In terms of funding any future improvements, it was suggested by several participants throughout the session that diversions need to be eliminated or at least reduced. “Legislative” diversions and funding Department of Public Safety with fuel tax revenues were specifically mentioned by one of the transportation funding advocates in attendance. Indexing the fuel tax to account for inflation was also recommended by one participant.

## CONCLUSIONS

Many businesses along the I-35 corridor see increasing congestion as a serious problem that has or will impact their businesses and/or employees. There is no clear consensus of what should be done to address this problem. There is some support for increasing alternative modes such as rail but this is primarily in the San Antonio area.

There is frustration in the DFW area with what is perceived as a “roadblock” by TxDOT. In this area many feel as if they have been left to develop their own solutions, including financing solutions, and now that they have done that they are being thwarted by TxDOT and others.

In the Temple area, participants feel that capacity and access issues are the most pressing issues with regards to I-35. Alternative routes need to be developed and extra lanes need to be added to I-35, particularly through Temple. Technology should be better utilized to convey traffic information to travelers. Truck traffic was less of an issue with regards to this session’s participants.

In the Austin area many participants felt as if more should be done to utilize existing infrastructure such as SH 130. Participants in this session said a more system-wide approach was needed because they felt that improvements to I-35 were not likely, although they did support adding HOV/HOT lanes to I-35.

In the San Antonio area, several people insisted that design issues with I-35 were a major contributor to the congestion. Like the Austin area, the San Antonio session participants expressed concern over the number of trucks on the I-35 facility and suggested separate facilities.

Participants in the Laredo business session do not see congestion on I-35 like in the other sessions but they do recognize that improvements need to be made now to prevent congestion like what they experience in other cities such as Waco and Austin. The concerns of this group focused on expanding the existing I-35 corridor rather than developing a new corridor, and increasing trade with Mexico.

As with the general public focus groups, business listening session participants suggested some short-term fixes such as improving and/or providing more traveler information, improving utilization of alternate facilities, and making geometric fixes. Although these participants had a much greater understanding of transportation funding and financing, they too, felt the problem was overwhelming. There was unanimous support for ending diversions and strong support for

increasing and/or indexing the gas tax. A few people mentioned that the gas tax would not be sustainable in the future and that other ideas such as VMT fees should be explored now.



## *Appendix A. Business Listening Session Discussion Guide*

### **Business Community Listening Session**

#### **I-35 Citizens' Advisory Committee Public Opinion Research**

##### **Part 1 – Sign Consent Forms (prior to beginning of focus group) – 5 minutes**

Participants will be asked to read and sign a consent form that has been approved by the Institutional Review Board at Texas A&M University.

##### **Part 2 – Welcome and Introductions – 15 minutes**

Thank you for taking time out of your busy schedules to talk with us. I'd like to begin by telling you about how the group will work and then we'll get down to the specifics of our topic for the day.

The purpose of the listening session is to find out your thoughts, opinions, and ideas on the I-35 corridor. We ask that you be open and honest. Don't worry if your opinion differs from others. We will be recording the session today but that is only for our own note-taking. Your responses will all remain anonymous.

I'd like to begin with introductions. Please give us your first name and what type of business you have.

Okay, now we're ready to get on with the topic at hand. TTI is working with the Department of Transportation to get your input on issues related to I-35. This effort is part of a larger citizen-based effort to discuss the issues related to travel on I-35 for both the general public and businesses. This citizen's group is charged with developing a plan for I-35 that reflects the citizens' and businesses' perspective. They and TxDOT want to know what you think. We have a few goals for this session today. We want to:

- identify what is or isn't working now in the I-35 corridor,
- identify the needs for the future, and
- discuss strategies for meeting the identified needs.

##### **Part 3 – Current Perceptions – 30 minutes**

I want to spend just a few minutes asking you about your travel on I-35. I want to focus primarily on what we're calling segment 2. This is the area that stretches from around the Temple area to south of San Antonio. I realize that travel all along I-35 may impact your business and that's fine too.

How does travel on I-35 impact your business?

How do you/your business use the corridor?

Does traveling on I-35 affect your employees? How so?

Do you know/has your business done any studies to find out where most of your employees live?

Do you know how many miles they commute?

Do you know how your employees commute?

Do you offer incentives for carpooling or taking other modes? (free parking, transit passes, vanpools, etc.)

What do you think IS working in the I-35 corridor?

What do you think is the biggest problem with I-35 today?

*Prompt for truck issues if needed.*

I have some handouts that I'd like to share with you about expected growth in this area **(handout population and demographic information sheets for each segment)**.

What do you think about these projections? Do you agree with them? If not, with what do you disagree?

Does anything about them surprise you?

#### **Part 4 – Future – 40 minutes**

I want to talk now about how we can accommodate this growth.

What do you think should be done to solve the problems of I-35 in your area?



*Prompt if needed.*

*Would you add lanes? If so, where, how?*

*Would you create an alternative or parallel facility? If so, where would it be located? What would it look like?*

*What about solutions that help move people and cars more efficiently (HOV/managed lanes, ramp metering)? Other strategies?*

*Would you consider rail? What kind (intercity passenger, commuter/regional rail, light rail, freight rail)? We won't explain the different kinds of rail at first. We'll see if the participants know the difference.*

*Some people have suggested building new freight rail lines that could be grade separated and move more freight by rail instead of by trucks on I-35. That could make existing rail lines going into the cities available for passenger service between cities along I-35. Would you be supportive of something like that?*

*How would these fixes be paid for? Talk a little about the current funding and the estimated needs (from 2030 report).*

*What would you be most supportive of? (increase in gas tax, local option gas tax, increase in general taxes for transportation, local option sales tax for transportation, VMT fee, toll roads; increase in vehicle registration and inspection fees; increase in auto rental tax; surcharge on tires, batteries, and other road use items; auto maintenance/repair surcharge such as oil changes and vehicle repair, etc.)*

## **Part 5– Implementation (Time Permitting)**

Who or what agency do you think handles projects like this?

Who or what agency funds these projects?

Is your local government involved in any way?

If so, who?

If you wanted to support or oppose these efforts how would you go about it?

How do you get the public involved?

Do you think anything will ever really be done?

If not, why not?

If so when?

What is the basis of your time frame?

**Part 6 – Final Remarks – 5 minutes**

Again, I want to thank you for your time and participation. I want to give everyone a chance to say any final comments.

## *Appendix B. Business Listening Session Notes*

### **Austin Business Listening Session: March 30, 2010**

#### **Participants:**

1. Texas State University San Marcos
2. Flynn Construction, Vice Chair for Transportation, Greater Austin Chamber of Commerce
3. Staff, Greater Austin Chamber of Commerce
4. Heldenfels Enterprises (pre-cast concrete)
5. Senior Project Manager, Heldenfels Enterprises
6. Seton Hospital System
7. HEB
8. Pape Dawson Engineers
9. Greater Austin Chamber of Commerce
10. ABC Home and Commercial Services
11. Real Estate Development
12. Engineering Firm
13. HDR

#### **Business Use of I-35**

7. We are a major user with over 52 million miles, 165 thousand store deliveries, and 225 thousand trailer loads per year. Twenty percent of our outbound loads are on I-35 and this number may actually be more. We have about 45 thousand truck loads on I-35 and a large portion of these come back for a total of around 400 to 500 thousand loads per year. Therefore, we are interested in anything that frees up traffic. We currently have large facilities in Houston, San Antonio, Weslaco, and San Marcos, and are building a new facility in New Braunfels.

2. We are currently working to direct traffic off of I-35 in peak periods. We wonder why HEB (participant 7) would not use the 45 and 130 toll roads, as it seems like these facilities would save time.

7. There was a study done regarding use of 45/130, of which I was not involved, but we don't think that those facilities would be cost effective given the number of loads we ship.

2. What if tolls were reduced or subsidized in some manner?

7. We would love to consider this and work on it.

Moderator: Is there a policy at HEB regarding when trucks travel?

7. Trucks run 24 hours a day, and there is no peak time.

3. So there is no increased cost associated with traveling in the peak?

7. Drivers are paid on an "activity based" system, and congestion does not affect this. We use toll facilities where it makes sense, such as in Harris County.

2. What "price point" do you need? Getting trucks off the road would increase flow, which would reduce fuel costs.

4. We ourselves are limited because 95 percent of our loads are overweight. We also can't travel during the peak period. Congestion is bad in the area and it makes it very difficult to get up north.

2. SH 130 indeed has restrictions on weight and axle loads. The bond restrictions on the facility mean that the owners want to reduce wear and tear on the facility.

Moderator: So are trucks the issue?

6. We have four facilities on I-35 with a lot of workers and patients, so having an I-35 facility that is "flowing and not clogged" is very important to us. We would also like to see accidents and the associated "trauma" decreased. It would be nice to have traffic diverted to 130. We also have a sister facility in Waco.

8. We drive I-35 mostly to Georgetown and sometimes to San Antonio. I was at the commission meetings and "Meadows" wanted a report in 60 days on incentivizing trucks to use 130.

Moderator: We did a study on this subject but the 45 connection was not completed yet. It would be nice to revisit the study now.

8. From my viewpoint the commission staff was "emphatic" about moving trucks to 130.

Moderator: The primary incentive identified in our study was reducing tolls.

10. Are there any numbers on utilization of 130? It looks empty to me.

(Over-talking )

3. 183, 45 North, and Mopac are ahead of traffic projections. 130 is behind.

12. There are a lot of trucks on I-35, and this points to a disconnect between road user costs. Everyone recognizes this but in practice it does not factor into people's "calculus." There is a need to make costs more transparent and visible, either through tolls or incentives.

3. What becomes interesting is the disconnect between use and cost as traffic in that traffic has become accepted as a part of doing business. This is a surprise. There needs to be a dialogue about driving down these costs.

2. I have identified three things:

- In terms of tolling trucks on I-35, this simply can't be done.
- Load restrictions and covenants on 130 need to be removed.
- The pricing system needs to be changed to induce trucks to use the facility. Perhaps try a 6 month trial period.

6. Congestion also increases air pollution, which affects the region in terms of non-attainment and other various health issues.

11. We travel to Dallas a lot. Trucks are not the main problem: residential development is, such as in Kyle. Kyle supplies a lot of workers to the area, and it is very cheap to live there. A lot of people are moving there and houses generate up to 10 trips per day and most of those will touch I-35. Right now we are trying to keep up with demand for services. It takes 45 minutes to go 18 miles into downtown sometimes, and taking trucks off of 35 will just put more cars on the

roadway. HOV lanes would be beneficial. I have used them in Harris County. We need to “look globally” for solutions.

10. We run small vehicles into and around Georgetown. Most of our employees cannot afford to live around here. They live in Kyle and Buda. They always have to come into the office and we are exploring the use of GPS technology so that workers do not have to come in all the time. We often try to route them near their homes at the end of the day. We do not provide reimbursements for use of toll roads in the area, but we are looking into that. It may allow us to make more deliveries. We pay on a commission basis.

1. We have a Round Rock campus, so our faculty that teaches there has to go back and forth to San Marcos. They are reimbursed for the miles they travel and the provost added a stipend for the cost of TxTags when the 130 facility opened. 130 could save our faculty up to an hour on their trips and it is better than wasting time and missing classes. Faculty only get the stipend if they use the toll facilities.

2. In the construction industry foremen often make up to \$20 to \$30 an hour. It is not a good use of resources to have them sitting in congestion. It is often cheaper to have them use the toll road.

Moderator: Have any of you done studies to see where your employees live?

1. We have done this for our students, and about 16,000 come from outside of San Marcos. This is only a “drop in the bucket” however. We have tried running shuttles and have a 42-bus fleet. I saw a study that noted that three of the biggest bottlenecks are in San Marcos.

6. We have worked with CapMetro before. If we are talking about I-35 we also need to be talking about Mopac as part of the system. There needs to be a “system wide” evaluation.

1. The bus system is supported by fees, and we are working with federal and state entities to acquire funding after the census. San Marcos should be designated an urban area after the 2010 census, which would mean more money for us. An Austin to San Antonio rail corridor might be a good solution.

3. We avoid I-35 “like the plague.” Mopac is getting bad as well. Major reconstruction on I-35 is going to be needed.

12. There is simply not enough infrastructure along I-35 to meet demand. TxDOT has to be a part of the solution. I-35 is the best option (the only option, really), as TxDOT does not have a rail division. This is a wasted opportunity. We need to look at all options.

11. We have twice surveyed employees, and over half live north of Mopac and 183. We keep moving out. We need to let employees figure out how to deal with this. We have given them flexibility but people want to live where they work. Good planning is required. We don’t want to force them to use Mopac and I-35.

(Moderator passes out handout.)

13. I agree with the numbers here. A temporary fix will only cause the new capacity to fill with cars in the absence of trucks. What is TxDOT doing in the short term to deal with trucks? I-35 has a lot of problems between Ben White and 183.

Moderator: Is it possible (and worth it) to expand I-35, or should other options be pursued?

8. In looking at future congestion, 130 should perhaps be “redesignated” as I-35 and shift traffic through that facility. We could then use managed lanes along the primary I-35 in the problem areas such as Austin and San Antonio.

2. Our leaders say that there is no money, so we need to maximize available resources. This would include moving trucks, using HOV lanes, and trying to get more money for I-35.

3. It seems like a new MIS on I-35 is needed so that the public can understand what is needed and can actually be done. It seems like in the short term businesses should work on commuting issues. “Everything needs to be on the table” given the cost of fixing I-35.

7. There are a lot of potential solutions. These include:

1. diverting traffic;
2. getting more trucks off the road, such as through lengthening trailers;
3. using long chain vehicles (these have been studied and safety can be maintained); and
4. implementing a freight shuttle system (long term).

Moderator: So where does freight fit into all of this? Would you use rail?

4. We cannot use rail. We don’t go near any rail facilities for our jobs and our equipment won’t fit on rail.

7. We use rail but it is not a significant part of our operations.

3. Ninety-three percent of truck traffic in the area “terminals” here.

10. Ben White to 290 is the worst part of the area for us. We would like to know how much of that traffic is local.

2. An HOV lane would get a lot of that local traffic.

3. Could TERP funds be used to offer incentives for trucks? What about using ramp metering?

Moderator: So there has to be a “pot” of options. But what about expansion of I-35?

4. I-35 is part of the business. Our big problem/concern is safety. We deal with a lot of different problems. All of the on-ramps, for example, cause a problem. Trucks have to slow down for vehicles getting on the roadway and then it takes a while for them to get going again. 130 would be a great alternative as it is wide open and has fewer on-ramps. All of our axle weights are legal, but often our gross weight puts us over the limit.

3. There need to be studies to show what the added maintenance cost would be for trucks on 130. This would allow businesses to make decisions in support or opposition of allowing trucks on the facility.

2. I-35 is maxed out in terms of expansion. It will be cheaper to “go out on dirt” as opposed to elevating. Bond restrictions on 130 should be reevaluated.

13. 130 will eventually be developed due to the lack of development restrictions.

8. But 130 has no access roads. Hopefully it will stay that way.

2. Once public infrastructure is placed in the area, such as water and wastewater, development will occur.

10. Developers in the county direct development. Development and utilities follow each other. This does not occur in urban areas.

11. State and local entities can do a better job of directing growth.

9. There were no incentives to grow out east, which is what the city wanted.

11. Problems have already been created in Buda and Kyle. Austin “never did utilities” and we are now trying to catch up.

12. I worked on the I-35 MIS study. Improvements such as adding a lane and HOV would not have significantly improved level of service.

13. There were certain areas that were “off limits” such as the State Cemetery but right of way was not as big of an issue.

2. 130 was just built. We need to look at how to utilize that and not at how to expand I-35. We might be able to get HOV on I-35.

Moderator: The public says that 130 doesn't help commuting, especially downtown trips.

11. There are not a lot people touching I-35, but lots on 183. HOV and multimodal solutions need to be explored.

2. But we can't do those things without getting trucks off of I-35.

10. But there are not as many trucks on I-35 during the peak.

13. There needs to be good ITS infrastructure. Travelers who might use 130 need to know how bad it is on I-35 going through Austin.

12. Those signs are there but are not being used. Seems expensive.

Moderator: We've discussed HOV lanes. What about HOT lanes?

8. That is what I was getting at before.

2. But we can't toll on I-35.

Moderator: There are programs for that.

13. If it takes 10 years to get it done then it is not much of a solution.

11. Removing truck traffic may be good, even though only 10 percent of traffic is trucks. This would reduce acceleration time and would require less road space.

2. I still think we need to get 130 “working and maximized.” Trucks are all over the place and getting them off the road would reduce idling time for all drivers.

3. Maybe the focus should be on maximizing 130 in the peak period and not just focus on trucks.

12. The signs at 45 and I-35 can be simple enough...they just need to say “congested.”

11. Origin and destination is an issue on 130. Not everyone is going all the way through.

8. The Texas Transportation Commission is trying to up the speed limit on 130 to 80 mph.

7. Not all trucks will go faster with a higher speed limit, such as HEB. We limit our speeds.

Moderator: So how should these fixes be paid for?

8. Raise gas taxes.

Moderator: Does everyone here know what they pay in gas taxes?

(Mostly yes.)

Moderator: So the solution is to raise the gas tax?

(Mostly yes.)

8. This assumes that there is the political will.

12. Why is raising the gas tax considered the “third rail” of Texas politics?

2. It is mostly due to “political imagery.”

Moderator: Does all money go to transportation?

(Group seems generally aware of diversions, specifically the 25% to transportation.)

Moderator: So you would be alright with an increase in the fuel tax but the increases would need to go to transportation?

8. Indexing should be done to avoid this problem in the future. The sales tax addresses this with its structure.

10. A substantial increase would help in other ways, such as by reducing trips and pollution. Infrastructure needs to be invested in.

3. There needs to be a lot of solutions.

7. Our approach is how to make money by lowering price and increasing volume. Perhaps we should look at 130 in this light.

10. 130 was supposed to be closer to Austin but it got moved out due to politics.

8. Allowing local option taxes is another option. Tolls should also be expanded.

3. Diversions should be ended.

8. Carona has said that diversions are a “smoke screen.” Other taxes would need to be increased for the offsets from the diversions. Diversions are not a big part of the total need.

2. The gas tax is not sustainable due to hybrids. Within 10 years the revenue stream will be declining. What about having a quasi-state agency, like the LCRA, that could generate a cash flow and revenue stream. This might allow for maintenance and expansion of infrastructure.

Moderator: How has the tolling situation in San Antonio been proceeding?

8. “Politics in that arena are dicey.”

Moderator: Perhaps the business community should help educate the public. In Jarrell we found a massive amount of misinformation permeating the group’s participants regarding toll roads.

12. Leaders have trouble grasping this, too. They don’t seem to recognize that a fuel tax increase is the best way to go.

9. Politics and getting reelected will not permit this. Politicians don’t want to raise taxes.

2. I am stunned to learn how little we actually pay for use.



9. What about expanding local alternatives (like 620 and 360) since most traffic is local.
8. Managed lanes are coming to Mopac with lots of other developments. What about VMT fees? These need to be discussed. We need to change the way we charge people and I like the idea.

Moderator: What do you all think about the concept?

(Not much disagreement.)

3. I personally pay a lot in tolls. Fuel taxes are negligible compared to that cost.

Moderator discusses concessions...

3. The only locally owned toll road is 183A. Would incorporating other toll facilities into CTRMA improve efficiency and address some of these problems? It would certainly increase the leveraging potential.

### **Closing Comments**

2. Regional planning is an issue. There are too many agencies. We are developing goals for regional planning.
9. Watson's bill dies quickly.
3. We need a "united front."
10. I'm surprised that local option does not generate more enthusiasm.

### **Dallas Business Listening Session: April 14, 2010**

#### In Attendance

Ft. Worth "Geotech" Company

Denton County

Tarrant County Judge's Office

DeSoto Printing Company

Mercantile Partners

University of North Texas

Ft. Worth Chamber of Commerce

Armstrong Development

- We are located in DeSoto, about a block off of I-35 E, and we have weathered the recent construction of I-35. I know that there is more construction coming and I live in Midlothian and the recent construction has made my commute easier. From what I have heard the new plans from TxDOT have more of a rural feel to them and are not representative of the growth that is going to occur in the area. I have seen the growth in congestion occur so I am very interested in seeing what kind of plans are being developed in this effort.
- There needs to be a focus on maximizing throughput and taking care of local access. There are a lot of vacant tracks along I-35 W in Ft. Worth and development is stagnant because of the congestion. It is difficult to attract occupants even within a few miles of

downtown because it is so difficult for people to get down there if they need to visit their clients. Ideally, the solution is to maximize throughput somehow, such as through expanding the lanes. And without local access, such as u-turns, you cut off all that development because people can't get to businesses. It is a twofold problem and you can't focus on one without the other.

- In the DeSoto area, the plan that came out to widen the road was focused more on the road itself and not the access, and the community said to go back to the drawing board. That pushed the project back 10 years but it was worth it. Improving the thoroughfare and the access (having an exit point just past one street so that you would have total access along that stretch and the entrance ramp that was just before the next intersection) was a great improvement.
- That is called an "X" ramp configuration and they are moving toward that in new development. If you remember back in the day they used diamond ramps but we are now back to x-ramps. In Denton County we have a lot of experience in these issues. We get in early and participate financially with the state in planning the projects. We are going to start working on I-35 W around the Tarrant County line. We get with all of the cities along the corridor and then go to the state with their issues. We can do this because we have an engineering firm on hand that can help with incorporating these issues into the plan.
- At 820 and 35 we had a local exit and entrance issue because of the interchange and a couple of exits were going to be eliminated. We suggested putting in new exits farther down and TxDOT had no interest in that.
- (Denton) But that is the Ft. Worth District. For the longest time they were in the "stone age" on mobility issues. But most of the trouble we have had has been from administration in Austin. The problem with I-35 isn't access and mobility. And it isn't coming up with the money. The problem with TxDOT and the State is that all of the delivery methods we can use for a project of this magnitude have either been taken away or are going to be taken away through legislative processes. We can design a road everyone wants and come up with the money but we can't deliver it. Right now the state does about \$4 billion statewide, not counting CDAs. We are currently pursuing pass-through financing but it is probably going to be taken away by the folks in Austin because there is some phobia about a private firm making a profit. But everyone makes a profit when roads are built. The issues are, with \$3 to \$4 billion in road projects a year statewide, you have one road from 635 to 380 that is over \$4 billion, and you have I-35 W that is another 4 billion, the funding scenario requires innovation. There is no courage to raise the fuel tax by the legislature. The feds will not help. They want us to

first study mitigating business impacts along the corridor. That is how they start putting their nose in this. They ask a question and the answer is to start promulgating regulatory processes. From the time you see cones go up on a road it could have been 16 to 20 that someone like us has been working on it and most of that time is eaten up with state and federal processes...making sure there aren't going to be any warblers affected and doing crap like environmental justice. And you are still seeing increases in congestion over that time. We need better project delivery, and I know TxDOT is trying, but they have never been good at working with the legislature. They need to let the locals use the chambers and local businesses to help out. Either help us or get out the way. The CDA has gotten a bad rap, but at every turn in the project whoever is working on it has profit built into their contract. There is value added at every transaction and profit is already in the system, but the legislature seems focused on the private sector not being able to make profit. We have had three CDAs up here and they all returned a profit of around 11 to 13%. When the North Texas Tollway Authority (NTTA) does a project they charge a 135 coverage ratio, and that is above what it costs to build the road. Fifteen to 35 is what is known as system risk, but we would call that profit. We expect 15 cents to come back on the dollar.

Moderator – But couldn't that be a requirement of the bond market?

- (Denton) It could be, but NTTA is actually at about 150 coverage ratio. My point is that everyone makes a profit. The difference between public and private, in a concession, is that if the revenue is not generated the developer is at risk. They go bankrupt if they don't generate the revenue and you still have the road. This happened in California. But the Texas legislature thinks it is bad for the private sector to make a profit on this risk and so they are taking away CDAs. So now all we have is pass-through financing (PTF), which means the state owns the risk. The state then asks the private sector what can be built for an assumed amount of revenue. But the state does not like risk Fund 6 funds, so they assume there will be less revenue, meaning that less roadway can be built. We were trying to get the commission to change their rules on PTF to be more like CDAs (to pay financing and coverage and to go out for longer times) but Nichols did not like that, so the commission let the comment period expire and now we are starting from scratch. This will affect those folks in DeSoto and south Tarrant County who cannot "self develop." Those who can develop, will. We in Denton are focused on 635 to 380 and from the Tarrant County line to Denton. The delivery tolls we have are going to innovate on 35 E and 35 W can be used corridor wide. In order to get anything done, you have to have a plan that everybody likes, you have to have one that carried the traffic, you have to have a financing scheme, and you have to have buy-in from the locals on that scheme. A CDA has several components. There is private finance and private debt. NTTA does not have equity; they are 100% debt. The private sector can bring equity to the table. When you have equity, you can get better debt coverage because you have "skin in the game." We (the county) have authority to incur debt, contract with private companies, and build facilities. So why do we need the state? Well we have to deal with the federal

government, and the people in the Grier building don't want us solving our own problems because they then become irrelevant. The county has a better bond rating than the state. We can take money and leverage it with private companies to reduce risk. But we have to go backward now to convince people that this isn't "alchemy" and have to convince the Grier building that we are not trying to supplant their usefulness, and we have to convince the federal government that we are consistent with their methods. If we can do as well as 121 was done, there is no reason this can't be done all the way between Laredo and OK.

Moderator – So you are saying that the current plans for 35 are fine; it is just the delivery method that is a problem?

- (Denton) We are bringing in our own engineering firm to develop the corridor plan for our area that is consistent with what the I-35 corridor coalition wants. TxDOT is doing the eastside, "the North Early," because it is not viable as a managed lanes facility. That part will come up just short of the confluence of 35 E&W. We know what the interchange will look like but we are not committing to building that. We are leaving that alone, but if we do a concession model it will be from 380 to 635 and will include the interchange but TxDOT has committed to doing the plans and funding, the short part from loop 288 to south of (inaudible). But what I am trying to say is that whatever innovation we do in Denton will work corridor wide and statewide. We believe that because of that we will have problems with TxDOT and the feds.
- I have had the opportunity to drive to Oklahoma several times and the need is clearly there. If there is one wreck traffic backs up. Between 635 and Denton it is bad.
- Talking about risk and profit... what are the assumptions on cost and what about inflation factors for cost? And how are the revenues estimated. Seems like you need to be very conservative so you are not building in a lot of "fat."
- The public sector has to be conservative and do the worst case scenario and will not move forward if there is substantial risk. Not so with the private sector. They are going to be more flexible with their assumptions in how they deliver the project. TxDOT had about 30 phases for the LBJ freeway. Cintra suggested it be dropped to five phases when they came because they don't make any money until it opens. I was told that on federal projects that cities within the corridor are eligible for 100 percent reimbursement on utility relocation. But that money goes through TxDOT in lump sums; all reimbursements statewide. But Austin does not give the areas all of the money they need for letting. Denton County is being asked to lend the region 57 million for the ROW on the LBJ freeway.

Moderator – Does everyone agree with all of this?

- I think it makes a lot of sense. It seems to me that this is a project that has three levels of interest: the metro areas, the state, and interstate. You also have to look at the projections of growth within 15 to 20 years—it is going to double. The roads won't be able to keep up, so there has to be a focus on mass transit. There is no political will for the gas tax, and I think there needs to be discipline to not spend the money we get on other things. There needs to be an “escalating element” in there that increases revenue and reduces driving.
- (Denton) I think I-35 E is as close as you are going to get to what the vision of the TTC was supposed to be. As part of the federal requirements we have other modes (rail) within the corridor. We are implementing the state's vision of the future for transportation but they won't raise the gas tax and help out.
- Somehow you need to form a coalition so that everyone is on the same page moving forward.
- I see no problems with what has been discussed.
- This all comes back to funding. If we had funding we would not be in this situation.
- (Denton) Not so. Our facility is just as much about managing demand.

Moderator – Does everyone know what managed lanes are?

- General - yes.
- It just seems that you can't talk about cross sections and all that without also discussing the funding situation. If we had unlimited funds you could build facilities with limited access that work to manage demand without tolling.
- (Denton) The state really did push what you are talking about in their managed lanes development but the way it was done it was worthless. It was not until Cintra came in that at-grade access and slip ramps were introduced and the public got on board. The funding pushes the facility design.
- But I think that funding is everything. These discussions would not be taking place if funding was not an issue. If you watch, there are already people asking him (Denton) for money.

Moderator – There are all sorts of areas that have had to step forward.

- (Denton) I'm not talking about stepping forward. We have fully funded our projects and it helps other regions but it is not altruistic. I am interested in what the public is saying because we have had extensive public input on I-35 E.

Moderator – So everyone is on board with the I-35 plans that are on the table?

- Well it is still in development.

Moderator –But everyone agrees something needs to be done, right?

- General – Yes.
- When the public is polled, do you ask about what their financial situation is? I imagine that who you are hearing from are people who think that it is their duty to look at these issues and feel it is their task to look forward on these issues.

Moderator – Question to chamber of commerce reps and schools: In terms of development, when you have people who are thinking of moving into the area, does the quality of life as affected by congestion influence their decisions?

- Yes. There is a reason you give helicopter tours on Saturdays, but now even Saturdays are bad. People from California that want to come here are saying we have a traffic problem.
- (UNT guy) I worked for Cap Metro for a while. I have been up here since 2003. What I have seen that is strange is that the reverse commute between Denton and Dallas is worse than the regular commute. The numbers are not huge but it is surprising. We are pushing for our students and commuters to live closer to where they work. Our rail will be finished late next year. Numbers will be small but there are concentrations here that will use it. We tell people to not bring their car to school and ride the bus. We are building a new stadium and I can see that in 10 years it will be a problem area. Where I-35 E & W come together is more important for us than getting back and forth to Dallas.
- (Denton) What we are doing is trying to partner with TxDOT and UNT to build pedestrian walkways. Denton County is earning 7 million a month in toll money.
- In Fort Worth we won't be able to attract businesses and they will get frustrated in the future. They are not so much frustrated now but they will be. We would like to move with rail.

Moderator – (Handout) So can you build your way out of congestion? Is transit a viable alternative?

- I have experience in this as I am called to visit our various franchises across the nation. We have a franchise in Chicago, and I took the blue line into town from the airport. At five o'clock that city shuts down, and everyone gets on the train. I got on the train, and the guy I was seeing had a nice house about an hour down the train and was close to the station. People would use that here.
- (Denton) What you have to keep in mind is the Metropolitan Statistical Area (MSA). The Chicago MSA is one fourth of the size of DFW, so it's a much larger scale and a much larger task.
- Well, it had a certain appeal. And it's not to say they didn't have highways there.
- (Denton) You can build a line mile for about \$5 million. You are talking twice that if not more for transit. We have 56 K cars that get off of 1171 and turn south on 35 in Lewisville. That's a lot of people.
- (UNT) Trains don't carry that many people. They are glitzy. I'm a bus guy. We increased ridership tenfold with a million dollar investment in vehicles.
- And I know people are trying to tie trains in with buses and integrate.
- (UNT) Well we will have a nice little train system with the DCA but you will have to utilize multiple different modes to get where you want to go. I think people are more likely to just use the bus and not have to switch modes.
- What makes rail so expensive? Seems like the rail is there.
- They are not the right kind of trains and railroads control the lines.

Moderator – Let's talk about highway expansion. Do you assume that all expansion will be managed?

- (Denton) We are adding both managed and GP.
- I have heard the expanded free capacity will never get built.

- (Denton) We know that in a few years the 18 lanes we are trying to build will be at capacity. But if you've got four managed lanes in there it cuts down on congestion and increases travel times. When you put in managed lanes, an auxiliary lane, and a functioning frontage system six GP lanes will carry a lot of traffic.
- Well I agree, but Tarrant County on the N Tarrant Expressway is coming back with four GP lanes and four ML.
- (Denton) The state has never been good at projecting future volumes. They are always under project. We built on 2499 and their 2010 projected volumes were current traffic in 1999.

Moderator – (Discusses public research we have done....transit....mileage fees....)

- Need to just index the fuel tax. Keep it simple. We have a system in place.
- But what about electric vehicles who are not paying anything.
- A lot of this relates to elected officials. They don't want new taxes (referring to mileage fees) being levied on their constituencies.

Moderator – Discusses mileage fees a little more.....Austin focus groups.

- I want to go back for a minute... We have one of the largest “urban knots” in the nation, but how many have access to transit? Maybe half? What does that say about our cars and our roads. We have been successful with a lot of piecemeal solutions here in this region. Other areas of the nation have had trouble, but we have at least been able to somewhat move forward. But to me, we lack an integrated plan that incorporates all modes. I think it is great that we are talking about rail in the I-35 corridor. We are going to have to raise the gas tax and we are probably going to have to do mileage fees. I just got back from Toronto, and they have a very old subway system. They also have streetcars and we were all over that city without having a car. I don't know if we are dense enough here to do that but we should start to approach solutions like that. We have tried for three legislative sessions to do local option and got slapped around for trying to find our own solutions. They are not going to have the guts at the legislature to do the things that need to be done. We are having delay after delay on finding solutions. When I started here there were no homes north of 820, but now it's jammed up there. So how are you going to resolve this without an integrated plan?

Moderator – Doesn't the long range plan address this?



- (Denton) It has to be fiscally constrained. The frustration I have is that the people who are supposed to be doing their job (TxDOT, FHWA, the legislature, EPA, others) are not doing their job and are keeping those of us who want to do our job from doing it.
- What is supposed to be the output of this effort here?

Moderator discussed the research effort.

- Where is Joe Citizen in all of this?

Moderator – We are doing those focus groups separately.

- My experience with TxDOT is that it takes up to four months to get a permit out of them for a driveway. We are talking about these mobility issues but it's pathetic that it takes so long for a driveway permit. All we wanted to do was to fix ruts from trucks entering our facility and pour some concrete. We submitted in December and did not hear back until April.
- We spent a quarter of a million dollars redesigning the Meacham Exit and the district finally accepted our design and then asked how we planned on paying for it.

(Moderator discusses trust issues with TxDOT.)

- You have the issues of diversions always coming up; the withholding of funds. Education is obviously going to be a huge issue.

Moderator – Who is going to do the education?

- We (chamber rep) are doing that. We do a “Budget 101” and have done so with healthcare issues. Things like that need to be done at the state and the federal level.
- Instead of cost per mile has this all been discussed in terms of cost per minute?
- (Denton) We do that at the COG. We take our maps from 1985 to current and show what the effect of congestion will be on travel times if funding is not received. But we all know the public is ignorant...so we are going to have ignorant people coming up with the plan. We have to find a way to get through the crap. In the meantime, somebody has to find a way to get these roads built, and what I need is for everyone to get out of my way. We have people getting killed on I-35 because it is a safety issue. Whenever the state tries to

solve its problems it's because of a federal lawsuit. But that is the only way the transportation problem is going to get solved...a federal lawsuit.

### **Closing Comments**

- I think people will take to transportation if you put it there. If transit is there they will use it. Buses are cheap. There is a new buzzword out there “active transportation.” It is basically walking and biking. Things like that can be done for cheap. The loneliest people in the world are driving around in their car, alone and angry.
- You guys (UNT) have done a good job. It takes some people 2 hours to get to our business park on other systems. You have to go pick people up and drive them around after that. Without a well set up system people are not going to ride it.
- We have to look at the sheer volume of SOV. We have to change that.
- Look at California. There was a lot of growth. As soon as there was an economic downturn they all came here. We can continue to ignore our problems but how much talking can we do? We need to get things done. It is up to a small group of people to do the right thing. We are really going to hurt from not making these decisions.
- (Denton) Redistricting is going to take the attention of the legislature, so this is not going to get solved. That is why I discuss delivery methods. We asked TxDOT that if we start tolling in our area we wanted an assurance that our funding would not be cut but TxDOT did cut our money and now they want us to fund everything ourselves.

## ***Waco Business Listening Session: September 30, 2010***

In attendance:

- 1: Representative of Hill Regional Hospital in Hillsborough, located right off of I-35
- 2: Panel Specialists, manufacturing, located right off of I-35,
- 3: Representative of Wilson Art, located off of I-35
- 4: Representative of Wilson Art
- 5: Representative of McLane Group, primarily logistics systems, lots of business with the army, also commutes a lot down 35
- 6: Lawyer, represents land owners and is also representing Wilson Art

Moderator: How does I-35 affect your business operations?

2. I have lived on I-35, in the Troy area, for most of my life. I have seen the growth. From a business standpoint we are affected by it. We are right on 35 and it is the best way to get north and south, as far as logistics goes it is great, shut downs from wrecks cause a lot of problems there are not a lot of ways to reroute traffic, if you get caught in a wreck you are there for several hours, incident management and a lack of alternate routes are among the biggest problems, we have a couple of incidents like this here recently.

1. We have had similar situations where employees who were supposed to be in at 8 did not get there until 11, it also reduces access to the hospital, when a wreck occurs on southbound 35 near the outlet mall, the ambulance cannot get on the interstate without going north to 77 and taking the entrance there to even get to the wreck, our emergency vehicles would use alternate routes but it takes a lot of time, with all of the accidents that are occurring, especially near Abbot on Friday and Saturday, you just don't want to be on the roads because there are numerous wrecks, it is an issue trying to get our vehicles on the roadway.

2. It is my understanding that it is partly the city's responsibility to aid in providing services for incidents on I-35, and when you are talking about a thoroughfare that has more people travelling through the city than the population of the city itself then that is an issue.

6. One of the concerns of the landowners we represent is access, there is a lack of frontage roads along the roadway as you cannot get around wrecks, capacity is also an issue as there are simply not enough lanes, entrance and exists ramps are too few and there are not enough of them, access roads also need to be longer.

2. I disagree somewhat. If you are overseas, and you are on the freeway, you are going through. We need a better frontage system so that you don't have to use the freeway as much.

6. I agree with that. If you are going locally and you have a way to avoid the interstate then that would be preferable.

3. It is 2 categories: there is access city to city and access in terms of exits and on-ramps (city to city), versus access within the city that happens to be on i-35, particularly where you have a lot of truck traffic like where you have on I-35. We have lots of distribution centers, and I-35 is our lifeline. Our service position is what puts us in the best position relative to competitors. We run

our own trucks and being able to get our trucks out is a big concern. Our trucks are going out all the time.

4. If our customers put in an order we can have it to them within one to three days, so delays really hurt us.

5. In our town (Temple) we have HEB and Wilson Art all on this loop that is a two lane road. There are lots of other businesses out there that are dispatching 24 hours a day. We changed to do nighttime shipping because we simply cannot afford to have trucks sitting on the roadway. We have to make 30 stops within a 12 hour period, and a lot of businesses cannot shift their times like we can. That kind of access is therefore critical and something has to be done with that loop before it becomes more of a mess. Also, there are simply not enough lanes between Temple and Waco and on Friday and weekends it is simply a parking lot. I have to take back roads like 317 to go around those choke points like Lorena and Hillsborough. These areas have to be addressed with either an alternate route (which was the plan earlier), but you have to be careful with construction because it makes it worse for a while.

3. We do team driving to account for hours of service requirements and traffic is making that worse because then we have two guys sitting on the road doing nothing.

Moderator- Did you have problems with receivers during this nighttime shift in deliveries?

5. It actually worked better for many of our receivers because they didn't have to conduct regular business while doing receiving. Fast food deliveries tend to be easier because they have "key" drops, where there are separate places where we can make drops without people having to be there. In Europe they do that a lot of that because cities are so congested and it is actually illegal to drive trucks into the center of the city because of congestion. We may be headed there.

Moderator – For those of you here whose businesses use trucks, do your trucks use toll roads? If so, who pays the tolls?

4. We do and the company pays for them.

2. Same here. Most of our trucks have TxTag.

5. Same for us.

Moderator – How does I-35 affect your employees?

1. We have a lot coming from north and south, but the big problem is for those coming from south. As I mentioned earlier, it doesn't happen all the time (incidents and delays) but it does happen. My issue is less than what would be seen with a shipping operation. Our employees have expressed concerns about the number of trucks on the roadway and how narrow it is. There are constantly safety concerns being expressed.

3. We have several Temple facilities and there is an informal network among employees set up where people will notify each other by text and e-mail about traffic conditions.

5. We have lots of ex military folks out of Harker Heights and they communicate with each other a lot about traffic conditions.

Moderator – So what about I-35 is good for you and your businesses? What is working?

5. I went into Austin a while back and the widening around Jarrel has really improved things. It was clear that that expansion has made a huge difference.

4. The entrance ramps in that area feel safer than the ones around Temple and Salado because these are a lot shorter.

1. The newer sections of the road are better just because of the pavement quality and things like that.

2. I-35 is the main artery for trade with Mexico and there is a lot of traffic moving down there that causes a lot of wear and tear, so it is good to have that expansion down there. We are going to need similar expansion.

Moderator –What are your thoughts on the truck lane restrictions north of Austin on I-35?

3. It is not an issue for our drivers in the context that there is plenty of capacity outside of those lanes.

2. A lot of trucks violate that restriction by passing because there are a lot of people driving in the outside lanes.

6. I saw it on my way up here. There is just not enough capacity.

Moderator -Are trucks the biggest problem on I-35?

1. Yes, I think they are.

3. If it is my family on the road then yes. They take up a lot of room and they can't accelerate and if something happens to one there is no room for error, especially given the capacity issues and the narrowness of I-35.

1. Sometimes you end up being side by side with a bunch of trucks because someone is in the left lane driving 45. It is very dangerous because they can't see you.

5. I think it is less of a problem. It is a problem with other drivers. People need to stay out of the left lane. It is for passing only. It is an enforcement issue. That is one of the major problems.

2. I have more difficulty with slow cars in the left lane over trucks. Also, there is a lot of debris on the highway that we have to dodge.

3. I want to clarify: trucks are not the issue in that they are unprofessional. It is just the physics of it. Lots of passenger vehicles don't know how to drive around trucks and it is just dangerous given the physics. It would be better for trucks to have "turf of their own."

Handout on population and traffic projections is given to participants

2. So... I was wrong. We have more people travel through the city in one day than what lives in the city itself.

Moderator – Is there anything on here that surprises you?

6. I'm surprised that Bell County gets worse even with the improvements going on. Same thing north of Waco, but others seem to stay the same. It seems like there is a lot of cost involved and it will get worse before it gets better.

2. Well everybody has to use it. There are no other routes. Belton and Temple are just right next to each other and it has all grown together and 35 is simply the route everyone takes.

3. What is an acceptable level of service for TxDOT?

Moderator - Level of Service (LOS) C is generally regarded as acceptable. (Moderator discusses LOS in more detail.)

3. There was an incident two weeks ago and the highway backed up on the northbound lanes and you could see police cars parked at intervals but you could never see the wreck. It made everything a parking lot.

2. I have heard complaints from the city that when there is an incident on 35 that they have to call people in who are off shift because they don't have enough people on hand to address the incident and still take care of the city.

Moderator-Do you agree with these projections?

5. I think they are too optimistic.

3. I agree.

2. I agree.

1. I agree.

5. I see no way that these values can be yellow.

Moderator – So how do we accommodate this future growth?

5. Technology needs to be used more effectively. You can use an iPhone to monitor traffic. If I, as a driver, had better access to traffic data I could start making plans early to take alternate routes. There ought to be a way to use the big boards on the side of the road to give real time information to drivers.

1. Yes. Let us know that there are going to be lane closures and such so that drivers can make plans.

Moderator - Do you pay attention to those signs?

2. Generally, yes.

Moderator - Have you seen the travel time signs in San Antonio?

5. Yes. I have seen them in Houston as well.

3. It prompts you to turn on the radio and to listen to the traffic information.

Moderator - But you said that the lack of alternate routes was a problem. How would traffic information help that?

1. Well, yes. The alternate routes you can find might take even longer.

2. The question is what is your use of the highway? I live in north Temple and often take the freeway and there are lots of entrances and exits for me to take. But it creates a problem if we have to use it like that and mixing with traffic heading into Austin or trucks that are on there.

Moderator – It seems like you are saying is that there is a problem with access. It is too hard to get around incidents but there is also too much access in terms of the freeway being used by everybody.

2. Yes. We need a better arterial system. We have had these same discussions in the rotary club. I am looking at this as a package deal. We need to fix a lot of things and you can't look at things individually. There are lots of things that need to be done to make fixes work. Lane restrictions don't work if the trucks have nowhere else to go. You (addressing 5) take 317 because that is the only other alternate but you are liable to run into a tractor there. When I-35 closes down all the traffic goes to 317.

Moderator - So, you can't limit access because there is not enough local capacity to support it?

2. Yes

1. Businesses probably would not want access limited anyway.

3. In a lot of small communities you have bypasses. I know as a business person though that you don't want bypasses.

Moderator - If there were another route that was a limited access facility, would it be worth it for you to move your company location so as to have better access?

2. That is too large of a question to answer.

Moderator – Well, at what point does I-35 become too expensive for you to use for your business?

3. It would have to be a considerable “delta.” We have a 13 acre facility that would need to be moved and I don't see it happening.

Moderator - What about expanding 35?

5. That is a good option.

ALL: Yes

Moderator - What would that expansion look like?

5. It has got to be six lanes through the city at a minimum. What they have done on the north and south end of Temple has to be done all the way through.

3. If you have segments that are improved it causes problems when that expansion ends. You are compressing four lanes into two.

5. Especially if they are successful at expanding the loop road that goes all the way around town. If you get those full four lanes running all the way through then that would solve a lot of problems..at least through Temple.

Moderator - What about right of way?

3. Well that will impact a lot of people.

Moderator - Is it worth it?

2. We need to get into some engineering, such as the deck in Austin.

1. Yes, like that.

6. From a personal standpoint I like the Austin deck. But I hear that it doesn't work and I always hear they are thinking about taking it out. When you get to the river it always gets bad, too.



2. And when you get o the split you don't know which one to take: the lower or the upper. I have been stuck on the upper deck for hours when there was an incident.

6. There are a lot of the problems with the lower deck. It is so dangerous.

Moderator – So we need to add more lanes on I-35?

1. Build out if the room is there.

3. The question for us is what is that going to look like? We stand to lose some facilities because of expansion.

2. You talk about loops... the retail business sector probably would not like that but you have to look at what you are using the roadway for. I think that no matter what you build there has to be a good frontage road system.

1. Loops can shut down the downtown areas. When you build a loop people start building around the loop.

2. Especially retail areas.

Moderator – But don't you think that cities along I-35 are established enough that?

3. I know that last year the City of Temple enacted some ordinances that addressed “architectural continuity” along the corridor. I think the plan was to make the thoroughfare nice and attractive, so it does not appear that they are planning on having that traffic taken away. No I have a question...this one graph talked about LOS in 2035 and projects being funded: The projects that would ultimately make I-35 look like it does south of Jarrell up through Troy and Waco... those are funded?

Moderator – Yes.

3. So, this map would assume that I-35 is six lanes all the way through with frontage roads. One of the things in Temple is the question of the overhead and whether you take that down. One thing that surprises me is that at the last meeting I went to on this they are talking about making this at grade level, and I asked how are they going to deal with construction during construction, and they said they had not figured that out. That concerns me.

5. I have heard that they are going to be doing high speed flyovers to and from I-35.

3. But you start getting this disconnect between funding and the loop development. Is this all being coordinated?

5. They are hoping to be able to divert a lot of the traffic to the west side of town.

Moderator – You heard they are going to be doing direct connects between I-35 and 363?

5. That has been discussed and it has been on charts I have seen.

(Moderator asks participants for clarification on the area being discussed.)

5. That is a four lane road until you get to 36, and then it goes down to two lanes.

2. When they did the planning the easement and so on was already there for four lanes.

3. The question then is timing. That really needs to be addressed before any work gets done to I-35 through the city.

5. If they can figure out how to get that loop completed traffic could be moved a lot more quickly.

Moderator – And then you could use traffic information to let people know about that route?

5. Exactly. But if you make everybody get off the interstate and then get on that road they are going to get stuck. It would be nice to get a flyover. I think once they finish the southbound work it will help a lot. I am kind of surprised that they are not doing that currently in other areas. They are working on that segment from Jarrell to Belton, making it six lanes all the way through and that is going to eliminate a lot of those issues. Except for the 190 interchange it will be clear but in Temple they are going to get stuck.

1. Are there plans to expand through Hillsborough?

Moderator – Yes (discusses plans in the area). So what about rail?

3. It is not significant to us. We use it for certain aspects of our raw materials, but it will not cause us to make strategic decisions.

Moderator - Is it worth investing in rail to get truck traffic off of I-35?

6. No.

3. A private concern has come in to switch the BNSF. This company moves cars to your facility which is often difficult. If they could improve the ability to get cars to our facility then that might be worthwhile. However, this assumes that you have rail access to your facility.

5. Rail would not be any good for us.

2. The issue for us is on the delivery side. We are delivering a lot of dorm furniture to colleges, so all our shipments are between May and August. Inbound is not that much of an issues as we have addressed many of those types of issues. It would have to be a full system upgrade for us to benefit.

Moderator – What about passenger rail? Would that help conditions on I-35?

5. I think it would require too much investment in infrastructure to make it work. We don't have the system to do what they do in Europe. It is a cultural thing and I don't see it happening in the next 30 years.

All in general agreement.

5. The problem is: what do I do once I get to where I am going?

Moderator -What about HOV lanes?

2. Enforcement would be the big issue. It could be great but you have to have a method for enforcing and maintaining it.

5. Express lanes would be better... just regular express lanes.

3. (Asks about moderator about HOV lanes)

Moderator discusses HOV and HOT lanes.

2. I agree with your (addressing number 5) comments about technology. I have seen in some areas where lanes change direction based on volume. I think that is something that could be done with the right technology. We should also be using technology for rerouting.

5. For the Temple area I don't see HOV making sense because employment is not concentrated anywhere.

2. I agree.

4. I would like to see an express lane where you could get on and go through urban areas.

Moderator – So what are you favored solutions?

1. 8 lanes all the way through, perhaps with some limited capacity. If you had six or fewer I would not limit capacity, though.

5. I agree.

3. I agree. We need to increase capacity in general.

5. We need to start acquiring ROW right now for future expansion.

Moderator – Let's talk about how to fund these improvements.

5. We need to stop sending money to Washington. What do we get back from Washington for every dollar paid?

(Moderator asks group about the fuel tax and their knowledge of it. Participants do not know the amount of the fuel tax. Moderator discusses fuel tax, the constitutionally mandated 25% to education, transportation funding and financing. )

2. Doesn't DPS get some of that money also? (referring to 25% to education)

5. Seems like the toll routes, like 130 in Austin, are a good solution, even though I hear that it is not working as well as they expected.

2. That is the gamble for me going into San Antonio. The route straight through takes shorter if traffic is fine, but it can be a lot longer if traffic is bad. 130 is reliable, though.

Moderator – What about express toll lanes?

5. How does that work in Houston? It seems like it would be a good idea.

(Moderator discusses the Katy Freeway in Houston and similar facilities.)

2. So they have all sorts of options? I think that is an important aspect.

Moderator – Would education work with regards to getting people to take surface roads as opposed to the highway?

2, 6, 3 – NO.

Moderator – Let's go back to funding. So how do we pay for all this?

1. I don't think I can figure it out.

Moderator – Well what are some options?

3. They tried the private thing and it didn't work. They had some PR issues. However, private money can be a powerful force. I just don't want it going through my area.

Moderator – How about raising the fuel tax?

2. It depends on what the federal government does. Are we going to be hit twice?

5. A lot of trucks never even stop here. Trucks coming in from Laredo and might make it though the state without ever gassing up here. They should be paying.

2. When the Panama Canal gets expanded, the port at Houston is going to get very busy. It will get worse around here, so yes, we should be capturing some of that. There are opportunities for taxation. I also think that there is an opportunity because Texans will support something if it is for Texas. There is a sense of pride, and Texans will pay more if they know it will benefit the state.

Moderator - What would be a reasonable increase?

2. I don't have enough information to make that decision. I mean what does a penny mean?

(Moderator discusses various highway construction costs and associated issues. Moderator clarifies some of the projects being discussed in the Temple area, as there is some confusion on the part of one participant (4) as to what is being done in the area.)

2. I don't think you would get a big gripe from businesses in the Temple area if you keep things somewhat the way they are, as people would still be getting off in the area and not just passing through.

5. I think it would be more valuable to complete loop roads as opposed to expanding 35. Developing alternate routes will be a better investment. I don't know if there is a cost differential but I think it would be a better investment to expand 35 from to 6 lanes and develop alternates rather than to just expand I-35 to 8 lanes.

Moderator – How much further would it be to take 363 around Temple as opposed to I-35?

5. It is about 5 miles.

3. If you totally bypassed, north to south, going straight through it would be about 2 to 4 miles.

5. The thinking is that if you go both directions you avoid the \$200 million flyovers and northbound traffic can be going on the east loop. The loop merges into 95 and there is nothing on the southeast corner down there.

(Moderator asks for clarification on the roadways being discussed.)

3. It meets I-35 in the same place as the northwest quadrant of the loop does. There are a lot of businesses that have encroached on that area, things like truck stops and such. What is the investment in flyovers in that area? You can't just leave 35 the way it is through Temple. You need some sort of investment there. Temple and Belton are growing, and you have to plan for that growth.

2. You're going to have to have some kind of alternate routes.

3. And who knows how the development is going to occur. In a few years a bypass might sense in other areas but where will you put it?

2. Was ROW purchased by the city for 2 lanes both way with frontage for the loop?

3. I think all of the ROW on the north side is there and in place.

2. That all goes back to the days of Ann Richards. They have been trying to get funding for that for a long time.

(Moderator discusses what the average driver pays in fuel taxes, etc...)

Moderator – Does what you are paying in fuel taxes seem reasonable? (Discusses other funding options.)

3. Yeah...(seems reasonable).

5. I don't think there will be one solution.

4. There will need to be a combination of solutions.

3. Can there be a guarantee that an increase in fuel taxes would go to transportation? I think that a lot of people would be more willing to support a fuel tax increase if it went to transportation

2. The local option got brought up and voted down, even though it was largely supported in the Dallas area.

3. People will be more supportive of increases in fees and taxes if they can see what they are going to be getting for their money.

6. I just don't think that there is anyone who will spearhead the effort. Nobody is going to take up the charge.

3. What is the opposition to local option?

2. It is just resistance to raising taxes.

3. And why keep earmarks as opposed to having local control? I guess I can see that earmarking benefits bigger cities, though...

5. In Europe nobody is in charge, so roads take forever to build because all of the local entities have control in their area. I can see why we need to have a little central coordination because nobody will want to pay for development in Houston if they don't live there.

### **Closing Comments**

1. Who funds the landscaping along overpasses? It is not being properly maintained in my area and they installed it wrong to begin with.

2. I agree with her. Is a lot of this even necessary? I think the state could do a better job of explaining things, like why they do certain things.

Moderator - If TxDOT told you your money would go to project X, would you believe them?

1, 2 - No, not really.

Moderator – Then how should TxDOT address this trust issues?

2. They need to do a media blitz and do lots of public education. I go back to Texas' sense of pride. They need to make it known that we are trying to take care of ourselves.

3. I can see having a transportation trust fund, but I then I see things like social security gets raided all the time.

***Laredo Business Listening Session: April 6, 2010***

Moderator: How do your businesses utilize I-35?

7. We own several warehouses along the corridor, so speed and safety are big issues. State and federal authorities don't understand the importance of the corridor. It is important to traffic from point a to point b. We should look to expand I-35 with perhaps more lanes and expand access roads. Truck traffic is coming back from the economic downturn, especially here in the past few weeks.

Moderator: Do you get congestion in the area?

7. Yes. There is new development and infrastructure at the World Trade Bridge that has helped things. The Texas Transportation Commission was trying to forego access roads but that was not popular as it limits access to farms and ranches.

8. I just made a delivery to Dallas and was worried about going through Austin but had no problems. Waco, however, was a problem. The inside lane truck restrictions helped and were a "big part" of making the trip manageable. I also live off of I-35 and at night it is "solid lights" down the highway from all of the trucks coming up from Mexico.

Moderator: What are your thoughts about a truck only lane?

7. That would likely get some result.

8. But then they would still be passing each other, which would cause problems.

7. There are problems from San Antonio through Waco, and adding a lane would likely get a lot accomplished. (Also, the Trans Texas Corridor is not very popular.)

8. The right of way is already there, so lanes should be added.

1. I support the idea of lane expansion. We are growing globally and it will keep expanding. Another facility would be expensive but an additional lane could work.

10. The Trans Texas Corridor is not supported by ranchers. The problem with adding lanes is the interchanges. You have to take property like businesses and cemeteries.

Moderator: So what should be done in the long term?

11. I-35 needs to be expanded but what are the downsides to this?

9. I have taken the 130 toll road before. "I love it."

8. San Antonio put a u-turn at 290 because people were making left hand turns, which was backing up traffic. The u-turn was a good fix. The biggest problem with the Trans Texas

Corridor was the taking of land to build something new when there is already lots of available right of way.

7. Loop-type roads are a good option so long as I-35 is not utilized for it. However, this causes ROW issues and land takings. It becomes a problem for land owners to donate land because land value goes up because of the new road but the landowner loses the ag exemption. There needs to be legislation to address this issue.

8. What about offering a tax abatement?

7. There needs to be 10 to 20 years of locked in value, unless use of the land has changed (such as putting in a gas station.) People are currently “disincentivized” to donate land.

Moderator – Do you have employees that are affected by congestion on I-35?

7. We have service crews that maintain the lines along I-35. When Loop 20 was constructed it was an actual loop but now it is all lights. That project has been going on for 10 years or more. The I-35/Loop 20 interchange should have already been done but it is now causing traffic problems.

Moderator – Why do you think these types of projects take so long?

7. I don’t know. Perhaps bureaucratic maneuvering resulting in all the money going to other places with more well connected people. I have had problems in Austin so that’s not to say that other areas don’t have problems, too.

3. We have employees that go up to Encinal and Cotulla occasionally, but it’s not really a commuting issue for us. TxDOT often has to coordinate with us on utility placement and they do things backward. For example, they extended 59 but did not do the overpass at that time.

1. It depends oftentimes on the equipment and trade authorities. We are not often affected by the corridor but we do support expansion.

10. The ranch community wants to know if the Trans Texas Corridor is dead. That is what we are concerned about. Also, our area has a lot of oil activity so there is a lot of new truck traffic.

8. I agree. There will be a lot of oil exploration in the Cotulla area.

Moderator – So how do you propose to deal with the increased truck traffic?

8. The feeder roads are already “breaking down.”

(Someone) Did the check point affect you? (to 1 and 8)

1. No, not really.

8. We move a lot of product in August and September. A lot of that goes to HEB. Time sensitivity varies.

Moderator – Is congestion a problem here? How about in the future?

10. It depends on Obama and his “amnesty” program. That is likely to make things worse.

8. We are time sensitive in the produce industry. There are a lot of agricultural products moving along I-35 that are time sensitive. For us it is very seasonal and it does affect traffic. It tends to be worse during harvest time.

(Moderator passes out segment information sheet.)



10. This shows that in the future there will be level of service (LOS) D in places where there is nothing, such as I-35 and LaSalle County Line. There is no place for traffic to get on that area, so I don't see why the LOS should be dropping in that area.

8. Yes. It should be green all the way down. There is no new traffic.

7. There may be areas where work is ongoing (and green) but in the future nothing is planned but it goes to yellow.

8. And why not just improve the road all the way down?

Moderator – That is a funding issue.

7. I would like to reiterate that people do not know how important this corridor is. Our leaders do not pay attention to Laredo. The improvements needed down here are not just for us. They would serve everyone.

Moderator – Are there any surprises in this or is there anything you disagree with? Have you all seen the population growth that is consistent with what is being shown here?

General “Yes”

9. Growth is coming from oil and gas. There have also been increases in tourism. However, it could “be all over” by 2023 because resources have been developed.

11. Roads need to be good but they shouldn't “break the back” of people in the area. Railroads and high speed rail could be good options but we need to be using I-35 more efficiently along with other existing ROW.

6. Yes. We need to make better use of medians and shoulders.

8. People have been saying this for a long time and TxDOT did not listen to them. It made people angry as the Trans Texas Corridor would have removed entire communities. We should look to make better use of existing facilities.

Moderator – So you think that needs can be addressed with existing resources and ROW through 2035?

Yes (6,8,10) explicitly, others nod in agreement.

Moderator – So what about the funding situation?

11. The state and federal government are in debt.

Moderator – How is transportation funded?

7. Not really sure but will say the gas tax. However, the money may go elsewhere. The Texas Transportation Commission makes a lot of these decisions and there are four to five members, appointed by the governor.

Moderator – How much is the gas tax?

6. Twenty cents per gallon, or that's what I heard it is.

11. And how much of that gets used on roads?

Moderator discusses funding.

6. So there's been no increase in the gas tax since 1991, but gas consumption has gone up. It seems that that should offset the declining revenue.

Moderator discusses effect of fuel efficiency on revenues.

10. "Taxes are taxes" and no matter what you call them that's the source that is available. Users should pay and we are all going to pay. Trucks also pay these taxes but the cost gets passed on to the consumer.

9. Why can't money from toll roads be used to address this?

Moderator explains pay-as-you-go financing and toll financing.

9. Once the bonds are paid off why can't the toll revenues go to other, non-toll facilities?

7. What about other fees like vehicle inspections and registrations? Couldn't these fees be increased? I pay \$50 to \$60 to register my vehicle and it doesn't seem that that has gone up recently. Just increase the registration fees and direct the money to highways. Also, counties should somehow manipulate their fees. Maybe that would take pressure off of the state.

11. Or what about some kind of EZ Tag type system that would use zip code information. A scanner would then be used to determine if drivers are not from the area and then charge them for use of the roadway system. It would be like a toll system that exempts locals.

Moderator – But doesn't this violate the "user pays" principle?

11. Maybe.

6. People around here will get several times under that type of system because they make a lot of short trips. You have to have a "buffer zone" where outside of that you are "using" the roadway and should be charged. Do that or simply subject locals to a lower fee.

Moderator – So going back to the gas tax... how much do you think you are paying per year? (No answers.) You are paying on average \$250. Does that surprise you?

3. Why has it not been increased? And why has TxDOT not gone to the legislature and asked for an increase?

7. It's because politicians want to be reelected.

11. We are taxed too much as it is.

7. What about ending this 25 percent diversion to education?

10. One hundred percent needs to go to roads. It's hiding an education fee in the gas tax. If we need money for roads the money should go to roads.

1. Where do customs duties go? In Mexico a large percentage goes to the state.

7. What about the federal fuel tax. Where does that money go?

Moderator discusses transportation apportionment and Texas as a "donor" state.

Moderator – So what about a 1 to 2 cent increase in the fuel tax that was dedicated to transportation?

(Not much support, if any..)

7. It's difficult to say. In the private sector you have to take money from other sources, so where will this come from? Politicians want to get reelected and don't want to make the hard decisions.

6. What taxes do fuel companies pay?

10. It will just be passed on to the consumer anyway, so it doesn't matter.

8. Where do truck fees go? And how can you make sure that money is going where it is needed.

#### CLOSING COMMENTS

10. We don't want the Trans Texas Corridor and I just don't trust the government.

7. TxDOT comes to public meetings and doesn't listen.

8. I agree. I was at those meetings.

1. There are a lot of goods coming through and going out of the country. This affects not just Texas. Therefore there needs to be more federal money invested here.

#### ***San Antonio Business Listening Session: April 30, 2010***

1. Zachry Construction — manage government relations.

2. Oversee used car lots; four are along I-35.

3. City council.

4. Barton Murrieta materials, operations.

5. Holt Caterpillar, move parts out of the warehouse in Waco.

6. Leukemia Foundation, 90 counties along the corridor.

7. ESI Unlimited consulting. Also government liaison for Team USA marketing company that distributes tires between New Braunfels and Seguin.

8. SAMCO, advocates for transportation funding.

9. Alamo RMA.

10. City of Selma, also represents Northeast Partnership for Development.

11. McCoy's building supply, handles real estate.

12. Regional Mobility Advocacy Coalition.

13. Charles English, English Consulting, especially concerned with 281, represents various businesses; really need to pay attention to 281 area.

#### Business use of I-35, how it affects business, employees

2. We have a lot of employees that live in New Braunfels (NB) and work in San Antonio (SA) stores and we have a lot of employees that live in SA and commute into SA. Coming from NB to SA (northbound)...those people have a long commute. But the folks heading from SA to NB do not have it that bad. The folks heading into SA from NB have really bad commutes and it is worse if there is a wreck; they are going to be late.

M - How do you handle lateness by your employees?

2. You can't do anything about it. And it adds an hour to their day... it affects quality of life.
12. I drive from Austin to San Marcos and I have noticed a lack of information, especially with regard to wrecks. It is easy to miss exits. We need to have information on conditions along I-35 prior to hitting 130 when coming north. I was in SA a couple of weeks ago and there was a wreck at a certain intersection... it was on the sign, but there was no other information provided.
6. We have people commuting on a regular basis up to Austin and we often have to spend non-profit money on hotel costs. I agree that there is a lack of information along the roadway. Perhaps one way to convey needed information would be to say that a wreck has occurred at mile marker "X."
8. I agree. If you are doing business in Austin and it is early in the day you often have to just make arrangements to stay there because traffic backs up at 6 in the morning. It affects a lot of people who have to do business in Austin.
7. Another thing to keep in mind is that real time information is good but a lot of the people on the roadway are not local. They will not know what the alternate routes are and so on. The location of wrecks alone does not do much good. Traffic does not affect my business much directly but there is a domino effect from businesses having to interact with each other.
9. We are worried about the degrading congestion levels and increases in wrecks. We also have to be aware of the new employees coming into the area, as most of them will be using I-35.
6. I-35 is a definite barrier for us. We have about 8 to 10 that run in different sections of 35 and if we are unfortunate enough to be there when there is a wreck it affects our delivery windows and affects the next day's deliveries. We run a shuttle type system where delays for trucks affect the other trucks on the schedule.
1. We typically build roads and we need to have heavy equipment delivered. That affects work schedules.
10. We sit at the confluence of three major highways here and there is a bottleneck at 410 and 1604. It is packed even on the weekends with cars going both north and south... five lanes in either direction completely blocked and it backs up to 3009. That has to be a priority. Yes, 130 will take some through traffic but with our growth the truck diversion will be offset by the new cars coming in. We are going to have 1600 new cars in Selma in the next year. There was a recommendation to restrict trucks to one lane and we need to clear accidents. Accidents cause onlooker delays. The use of signs to tell people to move over or take alternate routes would be beneficial.
11. Signs are good but maybe a dedicated AM station for traffic information might be better.
9. There is a "federally signed" station.
11. In the Kyle and Buda area there were no access roads and that caused real backups when there was an accident.
10. There also needs to be better coordination between the corridor committees and TxDOT. Everyone including the MPOs are having meetings on this.
13. There is a disconnect with TxDOT and the various planning agencies in working on these problems.

7. Everything we have talked about is an issue between personal vehicles and commercial vehicles. I have lived in Asia and NYC, and it seems to me that generally what you are looking for in a business perspective are solutions that offer mobility, flexibility and timeliness. We need to find new ways to separate all of this traffic in the future when there is an incident and we know that they are going to occur. We need to find ways to manage things so that everything does not shut down when there is an accident. It would be good to have viable alternatives, especially when traveling to other cities, so that you don't need your car. In Japan I could cross the island by walking, going to a subway, then a train, and then in reverse on the way back. I lived up in DC and NY and I drove 95 once while I lived there. It was easy to transition to other modes of travel and still do business. I had no excuses to not do so. With alternatives you don't have to mix with 18 wheelers. When I talk about alternatives what I am saying is that I am not even a part of the system when there is a breakdown. Most taxpayers are not going to fight money being spent on transportation so long as there is a "light at the end of the tunnel" and that there will be a solution. I get the freedom, but there are practical reasons to explore rail.

M - Who agrees?

8. I think it is a great goal but I have fought for rail funding at the legislature and there is a big gap between what we want to do and the available resources. It is a great goal but money is going to be the biggest issue. If the system is designed well people will use it. Look at DFW. We have to assume that pricing will be right and that the quality of the system is good. One problem is that you can only charge people about 20 percent of what it costs to operate.

10. Lone Star rail is working on a rail system and they are thinking 12 bucks from SA to Austin. We also have the 130 toll facility.

12. Rail is more than theory. Look at Lone Star rail: if UP would get off the line it would free things up. The reason a lot of towns out west and up north exist is because of the rail. A rail system in the area will dictate where development will occur.

Mod - Is rail going to help commuters?

12. It could.

2. But then how will they get to the office?

12. Well it will allow for development for other companies. Systems will develop.

2. We have millions and millions tied into our location. We are not going to move for rail.

7. His employees don't have to do a thing. Some other traffic being removed might still help him even if they are not using the facility. The money should not come from the government completely. We need to have buy in from the cities and those that will benefit from the rail development.

Mod - Sounds like you are talking about a lot of different types of systems: light rail, commuter, etc...it would all have to fit together.

3. On the idea of freight rail...I remember having a meeting with HEB and they were looking for freight rail options. They had a concept for the freight shuttle. Even something like that would help as HEB knows their numbers and they run all day. It would be a lot of vehicles.

10. I have noticed that we have a park and ride lot that is full. People are starting to get together. I did this back in the '40s when I was growing up. There are more people commuting in those

12-passenger vans. We also just opened up around 36th Street at the port of San Antonio and we have a lot of traffic coming in from Mexico; trucks will also be able to take 130.

M – What is the biggest problem with 35?

6. Bottlenecking. You can't go all the way through mainly due to volume, which is mainly cars.

13. Trucks, too.

2. It is a design issue as well. At 1604 there are bad on- and off-ramps. They cause congestion. There is always congestion through there.

11. It is frustrating to see ramps (northbound 183 at 35 for example) that are just opening and you know they are poorly designed.

7. A lot of that is caused by people just getting used to the new facility. If after a while it is still bad then yeah... it is a poor design. You have to look at who it was designed for.

8. I believe that with 410, 1604 and 281 (not the new, the old one) there were reasons that there were slow downs and as a result we had solutions that were not optimal. This happens all the time. The real problem is not the engineers but the people funding these projects. We have to acknowledge that.

7. People would rather talk about the problem. It becomes difficult to talk solutions because there is a funding issue. The reality is that I could care less about the funding issue for the purposes of this group.

12. The lack of options (routes and modes) and the lack of information about those options are the big problems on 35. If you don't know that you can spend \$5 to save 1.5 hours then it is not an option.

13. We also plan without consulting the people who will use the system. We need to have the people who will be benefiting on-board to go get funding and do the planning. We also need to get information out there like what (12) said.

2. What I would love to see in a perfect world is rail and an elevated highway for all through traffic (upper is for through traffic, lower is for local). The facility at Hilderbrand is great.

9. I agree. If we can separate trucks from passenger vehicles and buses, have different speed limits, have rail in the corridor...but then that sounds like the TTC. Talking about planning...we don't have a unified plan like Houston. We don't have a plan for the whole community.

M- Isn't that the MPO's job?

9. Not really. We have four modes all vying for their own money. Nobody is getting together, which increases the hope of getting more money.

HANDOUTS – Let's talk about solutions. You want alternate routes and modes....

10. We have a problem getting money, so let's consider what happens if we don't get money. When we have an accident out here the police do not move traffic. They need to keep it moving. And let's educate the people on ridesharing.

M – So build more park and ride lots?

13. Yes.

M – What about incentives for carpooling?

9. Yes, free rides for HOT.

7. These things are designed based on how people are going to use it. They are population specific. But the key incentive is time. These facilities are not being designed based on what people will do. What gets the people's attention? Time? People in New Jersey and NY will pay to save time. I am not saying that will work here but up there they were cognizant of what people's nature is.

13. We need to remain cognizant that non-attainment issues are here. The EPA has told us that we are close and they are going to be more aggressive and SA needs to have a plan.

M – Let's talk HOV. Are you taking a lane for that?

9. No. It is tough to take GP. It has to come along with an added capacity construction project. HOT lanes would be better as it is a benefit to have use of that lane for free. That type of project helps with attainment issues.

3. I think we have almost gotten the public into a reactionary situation. A lot of decision makers know growth is coming (look at "Brack"). That 410 N and I-35 north is way inadequate. We are going to be having new troops coming in; that interchange will be unbearable. And it relates to light rail. Light rail was shot down many years ago but now people think it is a good idea because conditions have changed. Right now people are just reacting to things.

Mod – It all goes back to information. All people know is that things are bad and it is someone's fault and it needs to be fixed.

7. We are talking about two types of information. There is information about road and traffic conditions and there is information about what the area is going to be like in 5 or 10 years.

13. You have a lot of truck traffic in that exchange. You have rest stops and warehousing and it is going to increase.

Mod – So what about separate lanes for trucks?

13. I have been working with "El Star" (?) about using freight tracks that are in the area.

7. I think what this touches on is about protected interests. Bill Gates said, and it relates to mobility, that if Santa Fe railroad in the 1800s would have realized that they were in the transportation business and not the railroad business then we would be flying Santa Fe Airlines. If I am John Q Public I think it is asinine that I do not have rail options here. They don't care about the fights between railroads and everyone over the rails. This handout is not a problem; it is a data element, you have to use the data or you get a problem later on. The public has trust issues because they have been burned even if the government is right. Interests need to come together in order to overcome trust issues.

12. Two things: population increase is coming so it seems that integrated solutions (rail, park and ride) will help determine where the growth occurs. Second: we have companies here who send trucks on I-35 but they haven't spoken about 35.

11. We have around 80 trucks. We are embracing more and more technology like GPS. Technology is a much cheaper and more immediate solution than rail. A lot of people are focusing on this but there is no silver bullet solution to this. One solution is getting the gas tax

back to paying for roads. There is also a problem with TxDOT caving to political pressure such as shoehorning ramps where they do not belong.

5. We would use alternate facilities if they were economically feasible but we have through stops. We have to make stops in Austin so 130 doesn't help us.

13. We are a military capitol...I have seen lots of caravans and are they being considered for these types of discussions?

9. They are not even required to let locals know about what they are doing.

11. Krusee said that we need to be charging people moving freight through Texas via Laredo. I would love to hear about some mechanisms for doing that.

7. But what are we charging for...wear and tear or are we charging as a deterrent?

M – A double-decker (DD) facility was mentioned...

2. Such as through towns...

M – Is there a need for some parallel facility?

1. There is a need but DD would be very expensive, way more than what the Trans Texas Corridor was going to be.

7. We need to address these issues based on what the needs are. Go out, where space is available, and go up or parallel when appropriate. People fight over changes to what they are used to. That is why tolling and usurping general purpose facilities for tolling are such big issues. Adding capacity gets an easier time of it publicity wise.

6. I was very impressed with Chicago's transportation system and they have very limited access through the city. They have opportunities for exits and entrances and they also have rail. The Chicago type system to me makes sense from SA to Denton.

8. I too spent a lot of time in Chicago. What you really have there on the 95 corridor is for many miles a combination of traditional highway with a parallel toll road with a transit system... often in the middle of the highway. And next to that is commuter rail. All of this is parallel. All of them are at maximum capacity but can you imagine if you had that here? That is why we support all modes. Chicago is a great example.

M – But are you not describing the TTC?

8. But what I'm talking about is not out in rural areas.

7. And it all evolved together.

M – So what do you do in downtown (DT) SA?

7. Depends on ROW.

9. I would suggest removing through traffic from the mix by building a nice expanded facility along 410. Leave DT SA to the locals. Or you could expand 1604.

12. Making 410 easier to use for trucks would be beneficial. It is too thin for truckers.

7. The reality is that it just shifts the problem from DT out to the bypass area.

12. NY has lots of modal options but it is not corridor style. You have alternatives.



M – So you want to expand capacity?

Yes.

13. All of the above. HOV, lane expansion, ....everything.

10. Are we looking at what we can do now? Separate traffic, have police move traffic during accidents (most important) and inform about ridesharing. We need to talk about cost savings of ridesharing. Employers can help with that. Different modes of transportation need to be looked at. The traffic we see in Selma is only going to go farther out into the rural areas. I know the MPO is looking to build inside 1604. But there are likely to be restrictions on that type of development.

M – Let’s talk about paying for all of this.

2. Quit diverting the gas tax.

M – Talks about fuel taxes...

7. It shocks me that our decision makers do not grasp this. Assessing on purchase price fixes that inflation problem. And yes, there are diversions but if you raise the gas tax by 10 cents today it could pay for everything that everyone has an idea on. And it would be cheaper than toll options to the consumer.

8. A lot of folks do not realize how much of that is tied into debt repayment. We are advancing transportation projects like a credit card. There is also not a lot of knowledge about maintenance expenditures. There is a huge investment requirement for maintenance. I love the 10 cent increase but it gets you another 2 billion and you need in the hundreds of billions. This would not fix problems even here in SA. That is only a piece of the solution.

(Most seem aware of 25% to education.)

M – What are the “other options”?

8. Need to look at phasing out diversions; mainly the legislative diversions and DPS. We also support local option taxes.

7. I think any one of those could work but it all comes down to having an overall plan. Without one it makes it tough to prioritize how things get spent.

M – Should you match your funding with the types of projects you are funding?

9. The public needs to know what is going on to identify the main problems. Then fill in the gaps. Congestion relates to safety and addressing congestion addresses safety. But you will never get enough money to fix everything.

M – So are you better off doing it piecemeal or doing it all at once?

7. You can’t confuse piecemeal with actually doing the plan.

12. I think that tax is a bad word. You would never be able to get that done. You need to convince people that the fuel tax is not a tax but a user fee.

M – What about paying by the mile?

12. Heavier vehicles do more damage and need to pay more. There are also too many opportunities to evade a tax like that.

7. But don't heavy vehicles already pay more at their registration? Doesn't that offset the damage they do?

12. And there are other mechanisms for funding for other alternatives, such as for rail you can get a TIF.

1. I think private equity needs to be considered for a lot of the large capital projects. It is not a one size fits all solution, but it is good for projects like the DFW Connector.

8. The problem is that that, private equity, is the first level of distrust with regard to the public acceptance.

2. Yeah, people always assume there is going to be a scandal.

1. The fee does not have to be set by the private entity. TxDOT sets many of the fees.

7. Things need to be addressed before hand; and people don't do so because they get lazy. I believe that it is our responsibility to educate, and I do that in open forums.

### Closing Comments

4. You have to figure out a way to pay for these things. We have not talked about conserving the resources that are there. I think that carpools and so on are a good and easy thing to do right now while we wait for other things to come up.

11. We have a lot of employees who come in their own vehicle because they often need to run errands. I believe that if we had a company car to use it might encourage carpooling.

3. There is a mistrust issue when you have three entities coming up with three different plans.

2. Yeah, I don't understand why we need all these bureaucracies. We didn't used to have all of this.

13. It's a result of lobbyists and consultants. And I think that it is a result of doings things piecemeal. That has to go. The good old boy program has failed. Grant programs get nicked and dimed to keep the funding coming and there is an attainment issue and we have spent the money foolishly and we need a plan.

6. The one thing we have not talked about is having more avenues to get people off of the road. I like to bike and there are not a lot of opportunities for that. I think all of these roads should have a shoulder and it is a cheap way of getting people off of the road. It doesn't have to be a bike lane.

12. I like the idea of an integrated plan but it needs to have all of the options on the table. There are a lot of real simple things that can be done right now. Park and ride, bike lanes... over time people will start to adopt these strategies. It removes cars.

11. We need to just make I-35 safer. I know that there are restrictions on small towns ticketing on 35...the disparity on speed on I-35 is bad and patrolling I-35 would really help.

6. Accidents on 35 are what really slow things down and there is no consistency on how accidents are handled. Minor accidents are handled like major accidents.

## **WORK REQUEST TWELVE: USE OF COPPER AND LEAD SLAG IN HIGHWAY CONSTRUCTION: LITERATURE SEARCH – MATERIALS USE AND CONSTRUCTION CONSIDERATIONS**

### **INTRODUCTION**

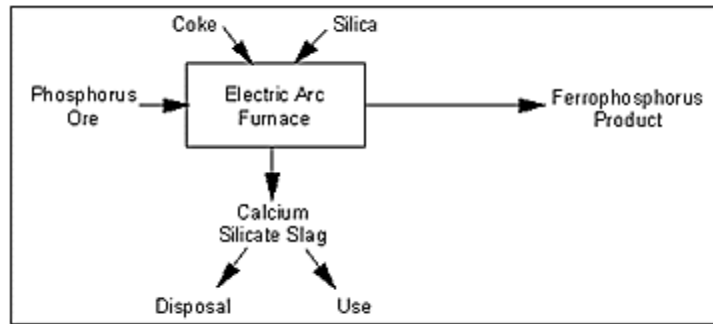
Copper and lead slags have been produced at the ASARCO facility shown in [Figure 19](#) since the turn of the century.



**Figure 19. ASARCO Plant in El Paso.**

Photo courtesy Special Collections UTEP Library: downloaded from NPR website [www.npr.org](http://www.npr.org) 2/4/10.

The slags are produced during the recovery and processing of nonferrous metal from natural ores ([Figure 20](#)). The slags are molten by-products of high temperature processes that are primarily used to separate the metal and nonmetal constituents contained in the bulk ore. When cooled, the molten slag converts to a rocklike or granular material.



**Figure 20. General Process Diagram for Copper and Lead Slag Production.**

In the mid-1980s, it was estimated that approximately 3.6 million metric tons (4 million tons) each of copper and phosphorus slag are produced each year in the United States, while the annual production of nickel, lead, and zinc slags is estimated to be in the range of 0.45 to 0.9 million metric tons (0.5 to 1.0 million tons)(1).

Most of the molten slag is dumped into a pit and simply allowed to air cool, solidifying under ambient conditions. Granulated slag is produced by using rapid water and air quenching that produces small, uniform particles. The cooling rate has a strong influence on the mineralogy and, consequently, the physical and cementitious properties of the nonferrous slags. Figure 21 shows examples of the sizes of the slag particles available at the ASARCO plant.



**Figure 21. Examples of the Range of Slag Particle Sizes at El Paso Plant.**

Environmental suitability is a major concern when considering using slag as highway construction materials in unbound applications such as granular base and backfill. Similar but lesser concerns exist when considering its use in bound applications such as hot mix asphalt concrete or hydraulic cement concrete layers. Materials from each source must be assessed for heavy metals content and leachability. The chemistry of typical slags is discussed in the next section of this report.

## CHEMICAL COMPOSITION OF COPPER AND LEAD SLAG

Table 21 shows the typical elemental compositions of copper and lead slag (4).

**Table 21. Typical Chemical Compositions of Nonferrous Slag, (%).**

| Element                        | Copper Slag | Lead Slag |
|--------------------------------|-------------|-----------|
| SiO <sub>2</sub>               | 36.6        | 35.0      |
| Al <sub>2</sub> O <sub>3</sub> | 8.1         | -         |
| Fe <sub>2</sub> O <sub>3</sub> | -           | -         |
| CaO                            | 2.0         | 22.2      |
| MgO                            | -           | -         |
| FeO                            | 35.3        | 28.7      |
| K <sub>2</sub> O               | -           | -         |
| F                              | -           | -         |
| MnO                            | -           | -         |
| P <sub>2</sub> O <sub>5</sub>  | -           | -         |
| Cu                             | 0.37        | -         |
| BaO                            | -           | -         |
| SO <sub>3</sub>                | -           | -         |
| Free CaO                       | -           | -         |
| S                              | 0.7         | 1.1       |
| PbO                            | -           | -         |

Table 21 shows composition of the major components of typical slag but does not present the heavy elements that can be present in concentrations in the parts per million (ppm) range. These are discussed in the next section.

### Heavy Metal Components of ASARCO Slag

Elements such as: arsenic (As), lead (Pb), zinc (Zn), beryllium (Be), cadmium (Cd), chromium (Cr), silver (Ag), and selenium (Se) are known to be present in slag, and these can be toxic to plants and animals if they get into the soil and groundwater.

It is the availability and leachability of these heavy metals that will govern the ability to use these materials in highway construction. Availability in this instance refers incidental human ingestion, dermal contact, and inhalation of particulates. Leachability is related to the phase and state of bonding within the slag. Elements partitioned into the silicates and oxides are much less mobile and will not readily leach. In order to properly characterize these phases, researchers must use the following techniques: X-ray diffraction (XRD), scanning electron microscopy (SEM/EDS), and electron microprobe (EPMA) analysis and synthetic precipitation leaching procedures. Appendix A describes these techniques.

Table 22 summarizes the heavy metal concentration data received from TxDOT. The data are from slag samples collected and tested in January 2010. All of the data have been converted to parts per million (ppm) or mg/kg to enable direct comparison of the data.

**Table 22. Heavy Metal Concentrations Measured in ASARCO Slag Samples.**

| EPA Method 6020 Analysis of ASARCO slag in Soil Matrix |                   |                 |
|--|-------------------|-----------------|
| Element  | Copper Slag (ppm) | Lead Slag (ppm) |
| Antimony   | 36.20             | 49.40           |
| Arsenic  | 265.00            | 663.00          |
| Barium   | 1380.00           | 626.00          |
| Beryllium  | 1.09              | 1.62            |
| Cadmium  | 14.80             | 59.70           |
| Chromium   | 9.16              | 11.30           |
| Copper   | 5310.00           | 6370.00         |
| Iron   | 10100.00          | 10100.00        |
| Lead   | 1620.00           | 1940.00         |
| Selenium   | 21.40             | 7.91            |
| Silver   | 10.70             | 23.60           |
| Zinc   | 15600.00          | 17200.00        |

Table 23 summarizes the heavy metal leachate concentration data derived from TxDOT slag samples taken and tested in January 2010. All of the data have been converted to ppm or mg/L to enable direct comparison of the data. The leachate results were obtained using a synthetic precipitation leaching procedure.

**Table 23. Heavy Metal Leachate Concentrations Derived from ASARCO Slag Samples.**

| Element   | Synthetic Precipitation Leaching Procedure Test Results by EPA Method 6020 |                 |
|-----------|--|-----------------|
|           | Copper Slag (PPM)  | Lead Slag (PPM) |
| Antimony  | 0.074  | 0.061           |
| Arsenic   | 0.050  | 0.010           |
| Barium    | 0.193  | 0.118           |
| Beryllium | 0.000  | 0.000           |
| Cadmium   | 0.003  | 0.064           |
| Chromium  | 0.009  | 0.000           |
| Copper    | 0.040  | 0.031           |
| Iron      | 0.200  | 0.150           |
| Lead      | 0.007  | 0.053           |
| Zinc      | 0.033  | 0.616           |

In addition, we obtained data from the Texas Commission on Environmental Quality (TCEQ) website concerning groundwater and surface water samples taken from the ASARCO site. Groundwater and surface water are contaminated at the site. Two separate sources have contributed to groundwater contamination at the ASARCO site. One source of contamination is attributed to two diesel releases from leaking petroleum storage tanks and the other source is from metals released from past plant smelter operations. The diesel and metal contaminated groundwater plumes are co-mingled. The primary Chemicals of Concern (COCs) in the groundwater are arsenic, lead, cadmium, and benzene. The most prevalent COC in the groundwater is arsenic. The groundwater plume is migrating westward toward the Rio Grande.

Based on surface water analytical data, the contaminated groundwater appears to have reached the Rio Grande. The latest surface water testing identified arsenic and antimony as the two primary COCs in the surface water.

## **DEPARTMENT MATERIAL SPECIFICATION 11000 TESTING**

TxDOT's Department Material Specification (DMS) 11000 governs the process for evaluating the environmental factors associated with non-hazardous recyclable materials (NRMs) not addressed in other Department specifications. The Department's goal is to use materials with environmental qualities that do not necessitate short-term or long-term management (i.e., worker protection, deed restrictions, tracking, monitoring, or special handling after the project life) in Department specification items.

As described above, TxDOT staff in January 2010 collected and tested unbound samples of copper slag and lead slag materials from the ASARCO site to determine if this material met criteria specified in DMS 11000. The results of these tests are shown in [Tables 22 and 23](#). The test results determined that the unbound copper and lead slag materials have environmental qualities that would likely present an increased risk to human health, the environment, or waters in the state when applied to the land or used in products that are applied to the land. Based on the DMS 11000 testing, the unbound slag should only be used in conjunction with short-term and long-term management controls and engineering controls that are designed to reduce the risk to human health, the environment, or waters in the state.

The primary chemicals of concern identified by the DMS 1100 testing were antimony, arsenic, cadmium, copper, lead, and zinc. Specifically the DMS 11000 slag testing determined the following:

- Total concentrations of antimony, arsenic, cadmium, copper, lead, and zinc in the slag each exceeded published risk based residential protective concentration levels for incidental ingestion, dermal contact, and inhalation of particulates.
- Leachate testing of the unbound slag determined that antimony, arsenic, cadmium, and lead each can leach out of the slag at concentrations that exceed known leachate levels from traditional Department aggregate materials.
- Leachate testing of the slag determined that antimony, arsenic, cadmium, and lead each can leach out of the slag at concentrations that exceed published risk based on protective concentration levels for drinking water.

Additional environmental testing is needed to determine if using the slag as a component in cementitious materials or asphaltic binders will reduce or eliminate the risks of incidental ingestion, dermal contact, inhalation of particulates, and leaching of metals.

The presence of heavy metals in the slag materials potentially precludes these materials from being used in unbound applications such as granular base or backfill. In fact, with the magnitude of the contamination it is difficult to justify considering the unbound slag materials for use in any application given the precautions required for worker protection, leachate mitigation, environmental contamination, liability, and associated costs. Each of these will have to be carefully evaluated and managed.

As will be described later in this report, the current remediation plan has classified materials on this site into Category I and Category II materials. Category I materials are those currently classified as problematic. The current plan is to bury these in a designated containment area. The materials with less risk associated with them will be encapsulated and covered with hot mix asphalt. There is potential for using these materials in on-site construction activities.

Critical steps in that determination will be to measure the leachate potential of these materials in a concrete or asphalt matrix. Methods of measuring leachates are discussed in the next section, and the test methods are described in [Appendix B](#).

## PHYSICAL ENGINEERING PROPERTIES OF COPPER AND LEAD SLAG

Little physical data are available on lead slag, but air-cooled and granulated copper slag have many favorable mechanical properties for use in highway construction. These include excellent soundness characteristics, good abrasion resistance, and hence good skid resistance and good stability due to high internal friction angle. [Table 24](#) shows typical values.

**Table 24. Typical Mechanical Properties of Nonferrous Slag (3).**

| Test   | Copper Slag |
|--|-------------|
| Los Angeles Abrasion Loss, %                           | 24.1        |
| Sodium Sulfate Soundness Loss, %                       | 0.90        |
| Angle of Internal Friction                             | 40 - 53     |
| Hardness (measured by Moh's scale of mineral hardness) | 6 - 7       |

Details of each material type are available at the following website: <http://www.tfhrc.gov/hnr20/recycle/waste/nfs1.htm>. The information from this site is summarized below.

### Copper Slag

- *Shape and Texture:* Air-cooled copper slag aggregates are black in color and typically have a glassy appearance. Granulated copper slag aggregates are similar to air-cooled copper slag aggregates but more vesicular.
- *Gradation:* Copper slag can be processed into coarse or fine aggregate. It should be crushed and screened to produce aggregate that satisfies the gradation requirements. Granulated copper slag can be blended with other suitable material as a fine aggregate.
- *Specific Gravity:* As a general rule, the specific gravity will vary with iron content, from a low of 2.8 to as high as 3.8.
- *Unit Weight:* Crushed air-cooled copper slag has a unit weight of 2800 to 3800 kg/m<sup>3</sup> (175 to 237 lb/ft<sup>3</sup>). The unit weight is somewhat higher than for conventional aggregates, resulting in increased density asphalt concrete (lower yield). Granulated



copper slag is more vesicular and therefore has a lower unit weight than air-cooled slag.

- *Absorption:* Air-cooled copper slag absorption is typically very low (0.1 to 0.5 percent). Granulated copper slag has a higher absorption than air-cooled slag.
- *Stability Characteristics:* The high angularity and friction angle (up to 53°) of copper slag aggregates contribute to excellent stability and load bearing capacity.
- *Wear Resistance:* The superior hardness and abrasion resistance of copper slag aggregates compared with most conventional aggregates contribute to good wear resistance.
- *Frictional Properties:* No specific data were identified.
- *Adhesion:* No specific data were identified, but low absorption values and the glassy nature of copper slag suggest that stripping might be a concern.
- *Soundness:* The excellent soundness exhibited by copper slag aggregate reflects good resistance to freeze-thaw exposure.

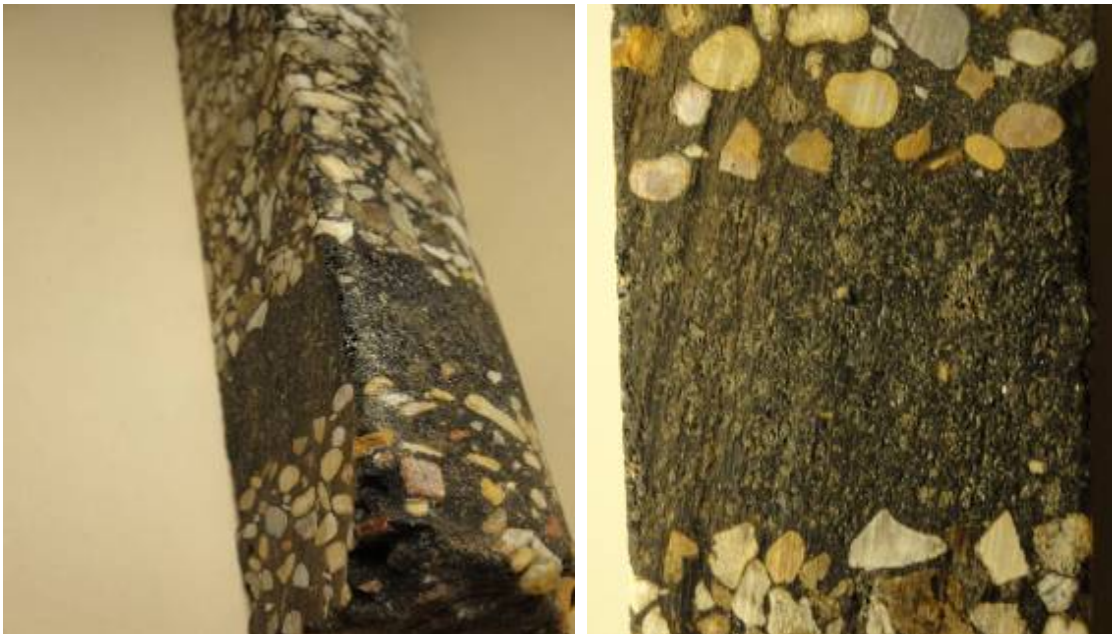
## **Lead Slag**

- *Shape and Texture:* Lead, lead-zinc, and zinc slags are black to red in color and have glassy, sharp, angular (cubical) particles.
- *Gradation:* No specific data were identified, but processing similar to that of copper slag would be expected.
- *Unit Weight:* The unit weight of granulated lead, lead-zinc, and zinc slags can vary from less than 2500 kg/m to as high as 3600 kg/m (156 to 225 lb/ft<sup>3</sup>).
- *Absorption:* No specific data are available on lead slag. However granulated lead slags tend to be porous, with absorptions up to about 5 percent. This could potentially be a problem.
- *Stability Characteristics:* Although no specific data were identified, it is anticipated that these slags would produce acceptable stability characteristics.
- *Wear Resistance:* Although no specific data were identified, it is anticipated that these slags would produce acceptable wear resistance characteristics.
- *Frictional Properties:* Although no specific data were identified, it is anticipated that these slags would produce acceptable frictional properties.
- *Adhesion:* Although no specific data were identified, it is anticipated that the glassy nature of slag suggests that stripping might be a concern.
- *Soundness:* Although no specific data were identified, it is anticipated that these slags would exhibit adequate soundness properties.

## APPLICATIONS OF COPPER AND LEAD SLAG IN HIGHWAY CONSTRUCTION

A literature search found the following points on slag applications:

- Recently this waste product has found use as an additive in Portland cement, as railroad ballast, or an additive for roofing shingles.
- One issue about slag preparation and processing is the toughness of the aggregates. Contractors complain about the wear and tear on all crushing and handling equipment.
- There are many applications of using slag in highway construction including ground granulated blast furnace slag (GGBFS), but this is mostly slag from the production of steel.
- Slag was widely used in hot mix asphalt (HMA) layers in East Texas in the 1960s and 1970s from the Alcoa plant in Rockdale. [Figure 22](#) shows a typical example. The very fine black layer is slag hot mix. This looks to have a gradation similar to TxDOT's current Crack Attenuating Mix (CAM) design, and this is a gritty mix, with good texture and no indication of any moisture damage.



**Figure 22. Slag in Old HMA Cores from the Bryan District.**

- A national slag association maintains a library of applications of slag and relevant specifications (<http://www.nationalslag.org/slagdocs.htm>). However, it deals mostly with traditional blast furnace slag and has little information on heavy metal issues.
- The best reference for slag applications in highways including copper and lead slag was developed by the Federal Highway Administration. Much useful information can be found at: <http://www.tfhr.gov/hnr20/recycle/waste/nfs1.htm>.

With reference to current and future potential slag applications in Texas, the following paragraphs describe standard specifications for possible inclusion of slag in TxDOT construction and maintenance activities.

### **Concrete (Item 360)**

Copper slag was used as a coarse aggregate (55 percent of coarse aggregate) in a section of continuously reinforced concrete pavement (CRCP) constructed outside of the district office in El Paso. The maximum aggregate size was 1.5 inches. After 12 years the pavement scores for this 7 mile section were in the 100s. There are no indications of any durability problems.

Magnesium has been reported to cause significant durability problems in hardened concrete. If this magnesium is present as MgO, then high concentrations in Portland cement will cause rapid volume increases and soundness problems, much the same as accelerated alkali-silica reaction (ASR) damage. However, if the magnesium is present in sulfate phases, then the sulfate can attack the concrete like typical sulfate attack. At this point we do not know how the magnesium is present in slag samples, but we know it is somewhat soluble because it is present in the water obtained from the site. The phase and concentrations of magnesium present in the ASARCO samples should be determined if the material is to be used in concrete materials.

Other potential problems with the use of the slag in concrete arise from the concentration of potassium and sodium; analyses of the copper slag show potassium levels ranging from 38 to 757 mg/L and sodium levels ranging from 124 to 1469 mg/L. Again, the researchers would like to stress the importance of knowing how these elements are partitioned in the slag samples so we can better gage the reactivity of these phases and the impact they would have on concrete constructed with this material. For example, if the alkali metals are present primarily in glass phases, then they could be released into the concrete more easily; glass becomes more soluble at high pH than silicate minerals.

In order to properly characterize these phases, the researchers recommend that testing of these materials be conducted using the following techniques: X-ray diffraction, scanning electron microscopy, and electron microprobe analysis. As described in [Appendix A](#), the equipment recommended is available at Texas A&M University and could be used to identify potential durability problems with using the slag in concrete.

A search of the literature found no reported performance problems using copper slag as either a cement replacement or as an aggregate in concrete. However results from Thailand (5) using lead slag reported lower compressive strength and substantially higher water absorption.

### **Hot Mix Asphalt (Item 341)**

In a 2009 survey no states reported using copper or lead slag in HMA. However, based on the material properties discussed above, there does not appear to be any reason why these aggregates would not make durable mixes.

As recommended by the FHWA in <http://www.tfhr.gov/hnr20/recycle/waste/nfs2.htm>:

Conventional asphalt mix design methods (e.g., Hveem, Strategic Highway Research Program [SHRP]) are applicable for the design of hot mix asphalt containing slag (particularly air-cooled phosphorus and copper slag) aggregates. No special procedures are required for

aggregate gradations. Both coarse and fine slag aggregates can be incorporated in hot mix asphalt, provided that the DOT's physical requirements are satisfied. No special provisions are required for nonferrous slag, and conventional hot mix specifications may be used. Blending with other suitable hot mix asphalt aggregates may be necessary to achieve gradation specifications compliance. Due to the difference in unit weights, mix designs are usually calculated on a volumetric basis.

### **Flexible Base (Item 247)**

The heavy metal contamination problem discussed earlier precludes this material from use in flexible bases. At this moment we will focus on applications in a bound and coated state (asphalt or concrete).

### **Chip Seals (Item 302)**

The El Paso District tried using the ASARCO slag material in a chip seal project in the mid-1980s. This was abandoned soon after starting because of windshield damage. The slag aggregates have such a high specific gravity that they caused numerous driver complaints. The material itself should easily pass the aggregate quality requirements but the weight issue precludes it from use in chip seals.

## **PROPOSED LABORATORY EVALUATION OF ASARCO MATERIAL**

Task 2 of this study calls for a laboratory evaluation of the materials at the ASARCO plant to determine their suitability for use in highway construction. The following steps are potential requirements in conducting that evaluation.

- A detailed review needs to be made of the TCEQ data on the test results and material classification from this site. The current material classified as Category I is scheduled to be buried in a containment cell. Based on the heavy metal concentration that material should not be considered for use in TxDOT projects.
- A large quantity of material is that which TCEQ classified as Category II materials. These should be considered for use in highway application. A survey should be conducted on the amount of this material, gradations, and potential applications. The laboratory staff in the El Paso District would be best to document and classify the existing Category II materials.
- The available Category II material's chemical components need to be identified in accordance with the requirements of DMS 11000.
- In all probability these components will exceed some of the limits of DMS 11000. At that time a decision needs to be made on whether to proceed with lab testing and potential highway construction.
- At that stage TxDOT Environmental Division needs to be consulted to develop a laboratory testing program that will ensure worker safety and minimize potential future liability to TxDOT.

- At this time it is proposed that only the applications of using this material in hydraulic cement concrete and hot mix asphalt concrete be considered.
- For the use of copper and lead slag in highway applications in concrete the material should be considered as an aggregate. Both materials have substantially less free lime than GGBFS (which is allowed in Item 421 as a partial cement replacement mitigation technique for alkali-silica reactivity). Therefore it is uncertain whether this material could be used to replace cement. The following steps are required to evaluate the potential for using both copper and lead slag as an aggregate:
  - Chemical analysis
    - To attempt to determine both the potential for durability problems (ASR type) and leaching problems the amount of potassium, magnesium, and sodium needs to be measured in both of the slags. In addition to this, whether the mineral is in the oxide or sulfide phase needs to be determined.
  - Item 360 testing
    - As already discussed, copper slag was used as a replacement for 50 percent of the coarse aggregate in concrete placed in the mid-1990s in El Paso. Laboratory testing should include both minimum compressive strength and flexural strength, comparing the virgin concrete with 25, 50, and 75 percent replacement with both copper and lead slag.
  - Water absorption testing
    - The water absorption of the raw aggregates and concrete cylinders needs to be measured. High water absorption can lead to major workability issues in the field and potentially lead to durability and freeze-thaw problems in the hardened concrete.
  - Leachate testing
    - As a final step because of the concern about heavy metal leaching from these products, TxDOT should modify and run a leachate test, which simulates worst case scenario. [Appendix B](#) of this report describes several leachate tests. They all involve passing de-ionized water through a column of material capturing the water passing through the materials and measuring the composition of the water. The simple 7 day test is recommended by TCEQ. To simulate the worst case scenario it is recommended that concrete cylinders be made cured for 28 days and then crushed. The crushed material will be tested in the leachate test.
- For the use of copper and lead slag in highway applications in hot mix asphalt the material should be considered as an aggregate. The following steps are required to evaluate the potential for using both copper and lead slag as an aggregate:
  - Item 341 testing
    - Both slags must be tested in accordance to [Tables 21, 22, and 6](#) in Item 341. It is not anticipated that any problems with requirements will be

found, as the slag is a very tough material. Based on the gradation, consideration should be given to including the slag in a Type D surface mix as either a coarse or a fine aggregate. Both copper and lead slags should be tested separately in the Hamburg Wheel tracking test, the indirect tensile test, and the Boil test. An experimental plan should be developed to consider 25, 50, and 75 percent replacement of both coarse and fine aggregates for both slag types.

- Mix design procedures
  - If the preliminary test results look satisfactory, then methodologies need to be developed to account for the high unit weight of the slag in the mix design process. Volumetric design will probably be required.
- Leachate testing
  - This is identical to the concern discussed above for concrete. To simulate the worst case scenario it is recommended that HMA be crushed as in a full depth rehabilitation operation. The crushed HMA can be blended with 50 percent virgin base materials and tested for leaching. The crushed material will be tested in the leachate test.
- Finished product will need to be tested to determine compliance with DMS 11000.
- Should the decision be made to construct field test sections containing these slag materials, monitor sites will need to be established to collect leachates that either run off the roadway or percolate through the pavement layers. [Appendix C](#) shows such a system using lysimeters.

## **CURRENT REMEDIATION ACTIVITIES PLANNED FOR THE ASARCO SITE**

Volumes of data can be found on the ASARCO case and the proposed remediation plan that will be implemented by the Custodial Remediation Trust. A summary of the proposed plan is presented below:

- Demolition of designated facility structures.
- Design, construction, and 50-year operation and maintenance of a ground water control system comprised of a 3000-ft slurry wall, ground water extraction well system, ground water treatment system, 800-ft deep injection well, and monitoring well abandonment.
- Capping total area comprising approximately 76 acres with asphalt, including 16 acres of designated Category II material.
- Design, construction, and placement of designated Category I material within an on-site waste containment cell.
- Installation and maintenance of perimeter fencing.
- TCEQ oversight, general maintenance, repairs, monitoring, and performance reporting on facility remedy in perpetuity.

A review of the proposed plan can be found in two expert reviews. In particular, the report by James Shih Hong Sher “Estimation of Costs to Perform Clean up at the ASARCO El Paso Smelter” can be found at the following website <http://www.tceq.state.tx.us/remediation/sites/asarco/asarco>. A second report by Mr. B. Costello concluded that the cleanup costs were “within a reasonable range.” Several major reports are available through this website providing the results of the years of detailed testing and the efforts to develop the comprehensive mitigation plan.

The \$52 million funding for this cleanup has been placed in a custodial account, and work is about to start on the cleanup itself. Status details and questions and answers about the cleanup can be found in the following website [www.recastingasarco.com](http://www.recastingasarco.com) (Figure 23). The final court-mandated order was issued in November 2009, and as of February 2010 this site is canvassing contractors who want to be considered in the bidding process to implement the proposed plan. It is hoped to have the final plan developed this year and implemented in the following 2 years.



**Figure 23. Website Developed for the ASARCO Clean Up.**

## **POSSIBLE TXDOT CONSTRUCTION THROUGH THE ASARCO SITE**

This cleanup process is under way and, based on the website information, events are moving fast. There is a “Building a Vision” grass roots effort supported by Senator Eliot Shapleigh to consider developmental opportunities for the site.

Based on similar cleanups already completed in Washington and Nebraska, substantial development of the area can be initiated once the cleanup is completed. The Qwest Convention Center was constructed on the site of ASARCO’s former lead refinery in Omaha, Nebraska. The EPA lauds the cleanup of the former ASARCO Tacoma Smelter site, stating that “ASARCO will also extend an existing path along the waterfront, design and construct the cap to support baseball fields or an amphitheater, and pave the remainder of the site to make way for new buildings. Cleanup and reuse activities have already begun.”

It is also possible that TxDOT could build a highway through the site, as construction projects through several other contaminated sites in Texas have been successfully completed. However, these past projects included large-scale reuse of contaminated materials as construction materials, which is being considered for the ASARCO site. As part of TxDOT’s decision-making process to determine whether the ASARCO slag can be incorporated into construction and whether a highway alignment can be successfully constructed on ASARCO property, worker protection, leachate mitigation, environmental contamination, liability, and costs associated with each will have to be carefully evaluated. As an example of potential cost, execution of the Soil Groundwater & Trash Management Plan (SGMP) for the SH 161 Project in Dallas (Landfill) for FY 2009 was approximately \$5.5 million. The affected section of the project is still under construction in FY 2010, so additional Soils and Ground Water Management Plan (SGMP) costs will be incurred before the project is completed.

Although not a comprehensive survey of public opinion, results from a January 2010 survey of the University of Texas – El Paso student government do not likely favor using the property as highway right of way. The results of the limited survey can be found at:

[http://www.recastingthesmelter.com/wp-content/themes/recastingasarco/downloads/UTEP\\_survey\\_1-28-2010.pdf](http://www.recastingthesmelter.com/wp-content/themes/recastingasarco/downloads/UTEP_survey_1-28-2010.pdf).

Should TxDOT wish to incorporate and start construction of a new highway alignment through this site prior to completion of the clean up, then there are several risks and challenges associated with this, namely:

- Drilling any type of foundation before a ground water extraction system is in place is problematic because extremely high levels of arsenic have been found in the existing ground water. The water table, because of the proximity to the Rio Grande River, is fairly shallow (reported to be 10 to 15 ft). TCEQ reports have also reported that some arsenic contamination has already reached the Rio Grande. Drilling deep foundation holes in this environment could cause other potential problems and make TxDOT liable for subsequent contamination.
- This entire remediation is approved by the U.S. District Court: Southern District of Texas, and modification to this plan will presumably need to be approved by the same court.

If the decision is made to proceed with either (a) construction of a highway through the facility and/or (b) using the materials from the facility as construction materials inside the facility, then



TxDOT's Environmental Division needs to become heavily involved with establishing the necessary environmental and engineering management plan. The Environmental Division has several documented cases where TxDOT construction has proceeded through sites where contaminated soils are present. In all cases the first step is to develop a Soils and Groundwater Management plan in accordance to the guidelines presented in Environmental Division Specification Item 221 ([Appendix D](#)). If the decision is made to process the materials for use as construction materials, then a worker safety and environment control plan must also be developed.

## **RECOMMENDATIONS AND FUTURE WORK NEEDED**

There are three main possibilities for TxDOT to participate in the cleanup of the ASARCO site in El Paso:

1. Allow for the use of the slag in highway construction projects away from the ASARCO site.
2. Realign the proposed location of the Border Highway West Extension project to run through the ASARCO site.
3. If running the highway through the ASARCO site, use the slag as part of the highway construction.

The following lists general work activities needed before the above possibilities can be pursued.

### **Possibility #1**

- Perform rigorous leachate testing on the recommended applications of concrete and hot mix asphaltic concrete, as per TxDOT specification DMS 11000.
- Perform additional environmental testing to assess potential future hazards when conducting maintenance, rehabilitation, or reconstruction activities.
- Perform standard material quality and mixture design testing.
- Develop and implement a tracking mechanism to track the location and usage of all material removed from the ASARCO site.
- Require potential concrete and hot mix material suppliers to obtain permits for the transportation and storage of all slag removed from the ASARCO site.
- Implement worker safety precautions to protect workers at all stages on construction.

### **Possibility #2**

- TxDOT would coordinate with the Texas Custodial Trust and their coordination with the public on the plan for development of the site.
- TxDOT would coordinate with TCEQ, EPA, and the U.S. District Court: Southern District of Texas, probably delaying the initial cleanup schedule.

- TxDOT would develop a Soil and Groundwater Management plan, which would include requirements for TxDOT monitoring in perpetuity.
- Modify standard construction practices (such as drilled shaft/piling construction, embankment and backfill construction, drainage details).
- Perform additional leachate testing to assess potential future hazards when conducting maintenance, rehabilitation, or reconstruction activities.
- Implement worker safety precautions to protect workers at all stages of construction.
- As the design for the current alignment, which skirts the ASARCO site, is 90 percent complete, redesigning for a new alignment would require additional engineering expense.

### **Possibility #3**

- All the issues of Possibility #2 would have to be satisfied.
- Perform standard material quality and mixture design testing.
- For the material to remain on site during construction, portable concrete or hot mix plants would be required as part of the construction contract.

It is a very real possibility that one or more of the above scenarios is possible, given the appropriate allocation of resources, including increased engineering costs for design and testing, legal fees, increased construction bid prices, the cost of the soils and groundwater management program, additional time for design, construction, and coordination with the Trust, the public, TCEQ, and the District Court, and the long-term commitment of resources for tracking and monitoring. Given that recent highway construction costs associated with a TxDOT Soil and Groundwater Management Plan is currently over \$5 million, it should be expected that implementing one or more of the above scenarios would cost far more than \$5 million. Development of a more precise estimate is outside the scope of this phase of the work performed by the authors.

### **REFERENCES**

- 1 Collins, R. J. and S. K. Ciesielski. Recycling and Use of Waste Materials and Byproducts in Highway Construction, National Cooperative Highway Research Program Synthesis of Highway Practice No. 199, Transportation Research Board, Washington, D.C., 1994.
- 2 JEGEL. Manitoba Slags, Deposits, Characterization, Modifications, Potential Utilization. Report prepared by John Emery Geotechnical Engineering Limited, Toronto, Ontario, 1986.
- 3 Hughes, M.L. and T.A. Haliburton, "Use of Zinc Smelter Waste as Highway Construction Material," Highway Research Record No.430, 1973, pp.16–25.
- 4 OECD Use of Waste materials and by products in Road Construction. Organization of Economic Co-operation and Development, Paris 1977.

- 5 Penpolcharoen M; "Utilization of Secondary Lead Slag as Construction Material,"  
Cement and Concrete Research, June 2005.



## APPENDIX A: ADVANCED TEST EQUIPMENT REQUIRED TO MEASURE CHEMICAL COMPOSITION OF SLAGS

The researchers have access to all equipment necessary to test the slag samples and determine their toxicity. [Figure 24](#) shows the Scanning Electron Microscope (SEM) located on the Texas A&M University campus. [Figure 25](#) shows the electron microprobe. [Figure 26](#) shows an image from a meteorite taken with the electron microprobe that can be used to determine how elements are bound in a sample. The X-ray diffractometer is not pictured, but it can tell the crystallinity of the different phases to help determine how immobile the heavy metals are in the slag.

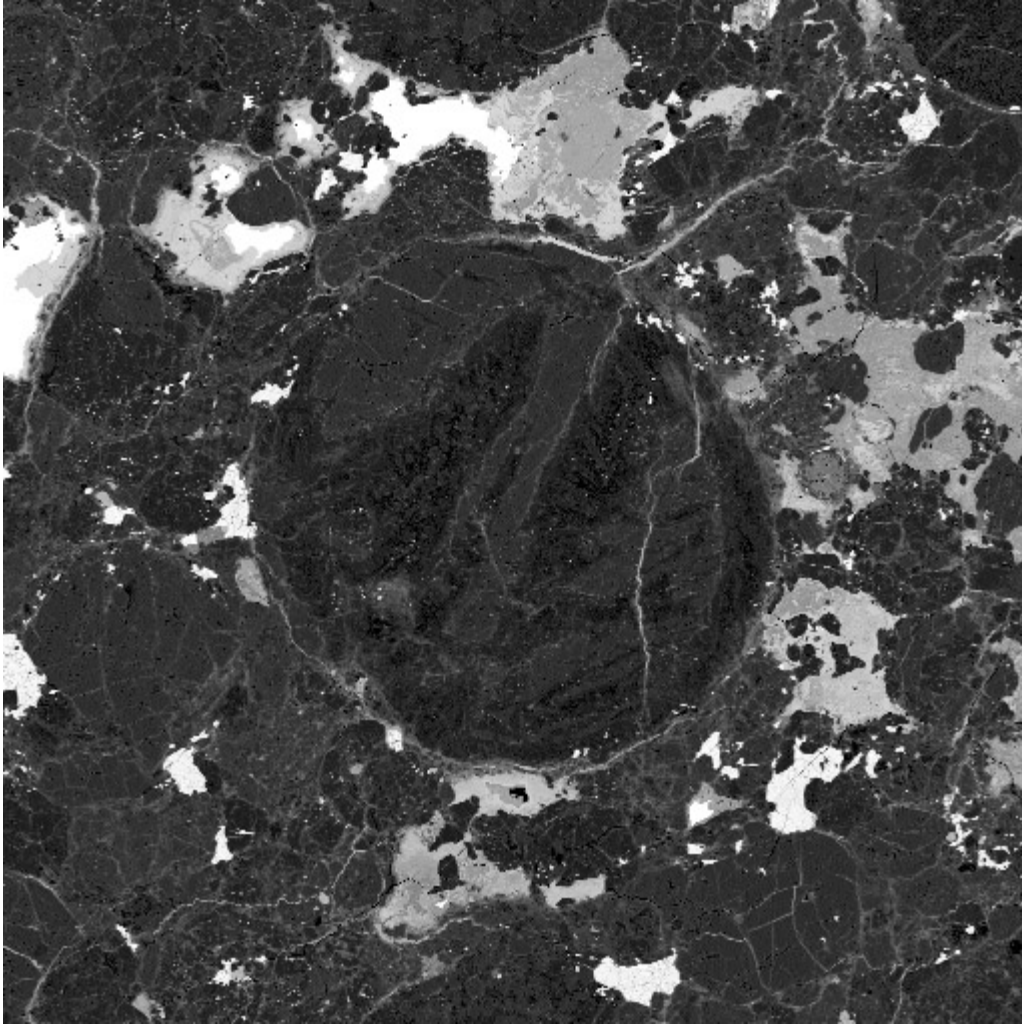


**Figure 24. JEOL 6400 Scanning Electron Microscope at Texas A&M University.**



**Figure 25. Cameca SX50 Electron Microprobe at Texas A&M University.**

Taken from [http://geoweb.tamu.edu/RRResearch/probe/%20Probe\\_WebPage.html](http://geoweb.tamu.edu/RRResearch/probe/%20Probe_WebPage.html)



**Figure 26. Backscattered Electron Image, Taken with The Electron Microprobe, Showing How Different Elements Are Bonded Together in a Meteorite.**

Image taken from [http://geoweb.tamu.edu/Rresearch/probe/%20Probe\\_WebPage.html](http://geoweb.tamu.edu/Rresearch/probe/%20Probe_WebPage.html)

## **APPENDIX B: RECOMMENDED LABORATORY LEACHATE TESTS**

Although slag has beneficial uses, there is some concern about its potential human and environmental hazards, since it may contain various levels of metals and other constituents. Several tests (batch and column) have been employed to simulate leaching from these materials in the field. Careful thought and planning must be used when choosing a leachate test because each has its own potential benefits and drawbacks.

Batch tests are usually low cost, easy to operate, carried out over relatively short periods of time (hours to days), and experimental conditions (e.g., pH) are relatively easy to control. However, batch tests sometimes are associated with arbitrary and high liquid: solid ratios (L/S), which is the ratio of extracting liquid to solid waste materials. Often such high L/S ratios will not exist under field conditions. Column tests, on the other hand, may be closer to field conditions, and the material under testing will largely dictate experimental conditions such as pH. Column tests can prove time consuming (tests over days and months), relatively costly, and be associated with problems such as channeling of materials along column walls and clogging ([Townsend et al., 2003](#)). Below are a few leachate tests that are currently used.

### **ASTM D3987-06 – Standard Test Method for Shake Extraction of Solid Waste with Water**

This is an agitated extraction test that is used to determine the mobility of inorganic constituents from waste material. A representative sample and reagent water (Type IV- ASTM D 1193) with a 20:1 liquid to solid ratio (L/S) is shaken on a rotary agitator for  $18 \pm 0.25$  hours at 30 rpm to rapidly produce leachate. The aqueous phase is subsequently separated and analyzed using the appropriate procedure and instrumentation. The intent is to produce leachate that is an estimate and not a representative of that which would be formed under field or site-specific conditions. The conditions used in the test (e.g., agitation rate, L/S) may not be suitable for extracting constituents from all forms of waste materials. As a result, it is explicitly stated that this method should not be the sole determining factor for engineering design ([ASTM, 2006a](#)).

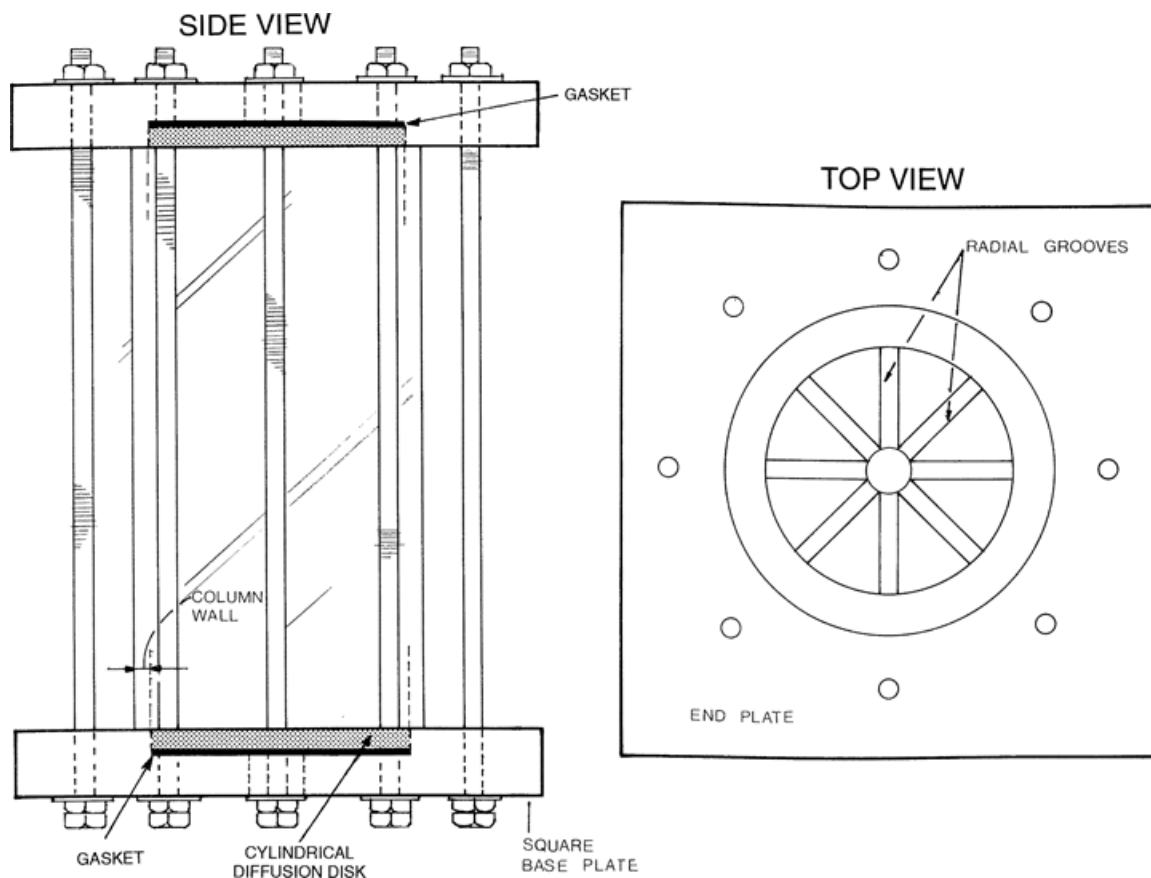
### **Texas Seven-Day Distilled Water Leachate Test**

This method, which is used by the TCEQ, is intended to be used on dry solid waste that does not contain any free liquid. A 250 g (dry weight) representative sample is first placed in a 1500 mL Erlenmeyer flask, 1 L of deionized or distilled water is added to it, and the material is mechanically stirred for 5 minutes. The mixture is allowed to stand for 7 days, after which the supernatant is passed through a 0.45  $\mu\text{m}$  filter and further subjected to the appropriate analysis.

### **ASTM Method D-4874 – Standard Test for Method for Leaching Solid Waste in a Column Apparatus**

This method uses a column apparatus ([Figure 27](#)) in which reagent water is continuously passed through a representative sample of the waste material in a saturated up-flow mode. The intent is that semi-volatiles and volatiles and the maximum amount of metal species will leach from the solid. The method was written in a manner such that the user can adjust the specific operating conditions to meet particular objectives. The results obtained from this method will depend on the characteristics of the solid waste being tested and the specific operating

conditions. As a result, the method explicitly states that it cannot be used as the only basis for engineering design of a disposal site (ASTM, 2006b).



**Figure 27. Column Apparatus (Adopted from ASTM D4874-06b).**

## References

ASTM, 2006. Standard Test Method for Shake Extraction of Solid Waste with Water. ASTM D3987-06a.

ASTM, 2006. Standard Test Method for Leaching Solid Waste in a Column Apparatus. ASTM D4874-06b.

Townsend, T; Jang, Y and Tolaymat, T., 2003. "A Guide to the Use of Leaching Tests in Solid Waste Management Decision Making," Florida Department of Environmental Protection, March 31, 2003.

\*Note\*. The Seven-Day Distilled Leachate Test is cited in 30 TAC§335.503 (relating to Waste Classification and Waste Coding Required); 30 TAC§ 335.505 (relating to Class 1 Waste Determination); 30 TAC§335.507 (relating to Class 3 Waste determination).



## APPENDIX C: RECOMMENDED FIELD LEACHATE TESTS WITH LYSIMETER

The lysimeter is a large catchment box typically 12 ft by 12 ft where the moisture entering the pavement and running through the base is captured for analysis in a large collection tanks (Figure 28).

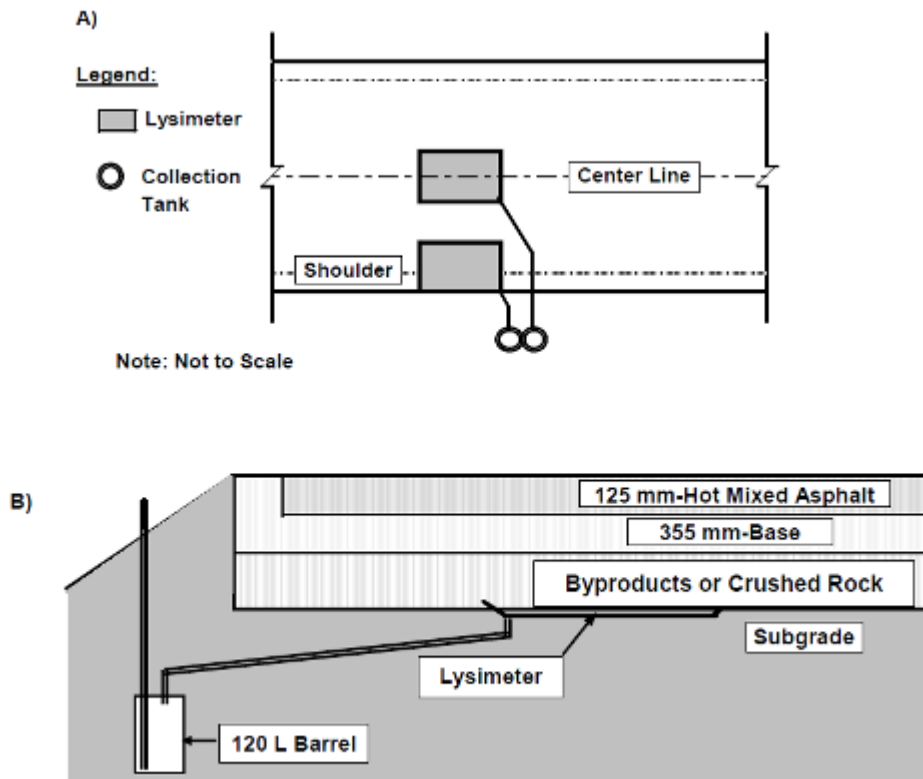


Figure 28. Field Site to Capture Leachates from Experimental Bases.

### References

Sauer, J., Benson, C., and Edil, T. "Metal leaching from highway test sections constructed with Industrial Byproducts." Geo Report 5-21, Department of Env Eng, University of Engineering University of Madison Wisconsin, Dec. 2005.



## **APPENDIX D: ITEM 221 SOIL AND GROUNDWATER MANAGEMENT PLAN(S)**

221.1 Description: The procedures required to create a Soil and Groundwater Management Plan (SGMP) for the mitigation of contaminated media related to TxDOT construction activities. If directed by the Statement of Work (SOW), the SGMP will become part of a special specification that will direct construction contractors on how to manage and dispose of contaminated media within a construction zone.

221.2 SGMP Style: The Engineer/Technical Expert shall utilize the following limitations/standards when preparing the SGMP:

- State the Contractor's requirements only once (other than as part of process flow charts) and do not include an executive summary;
- Do not give options (multiple methods) to the contractor in detailing how to manage each contaminated media;
- Prepare the plan as a directive, using imperative voice;
- Always capitalize CONTRACTOR, ENVIRONMENTAL SPECIALIST, or TxDOT when directing them to perform a task; and
- Utilize cost effective procedures and easily purchased products, as applicable.

221.3 Procedures: At a minimum, the Engineer/Technical Expert shall prepare the SGMP to include the following, unless otherwise outlined within the SOW.

221.3.1 SGMP Zone – Indicate the exact location on a depiction of the Project Plan Schematic and within the initial paragraph of the plan where the SGMP starts and ends using the construction project plan station numbers.

221.3.2 Contaminated Media Information – Summarize past studies performed on the subject site detailing:

- The chemicals-of-concern and their concentrations;
- The impacted media (surface soils, surface water, subsurface soils, sediment, groundwater, etc.);
- The known and/or suspected horizontal and vertical extent of the contaminated media; and
- The potential hazards/exposure impacts to construction workers.

221.3.3 Summary of potentially impacted construction improvements – Detail what part of the construction project will potentially be affected by the contaminated media (storm sewers, bridge piers, abutments, etc.)

221.3.4 Soil Management – The Engineer/Technical Expert shall evaluate methods to manage contaminated soils potentially impacting improvements within the SGMP zone. The Engineer/Technical Expert shall take into account costs and ease of construction (the least impact to normal construction methods while still providing effective management of contaminated soils). The SGMP shall include detailed written methodologies on managing the potentially contaminated soils within the SGMP zone. The Engineer/Technical Expert shall include the rules and regulations that govern the methodologies chosen.

221.3.5 Groundwater Management – The Engineer/Technical Expert shall evaluate methods to manage contaminated groundwater potentially impacting improvements within the SGMP zone. The Engineer shall take into account costs and ease of construction (methods with the least impact to normal construction while still providing effective management of contaminated groundwater). Different techniques for groundwater disposal may be used under this heading, but shall be based on a total gallon limit for the project, or as directed by the SOW. The SGMP shall include detailed written methodologies on managing potentially contaminated groundwater within the SGMP zone. The Engineer shall include the rules and regulations that govern the methodologies chosen.

221.3.6 Construction Materials – The Engineer shall evaluate all construction products proposed to be used within the SGMP zone for the following items listed below. The Engineer shall include a written description of the findings and/or alternatives within the SGMP, upon concurrence by ENV-PPA and the Point-of-Contact (POC) outlined within the SOW. If alternatives to the original design are recommended, then the Engineer shall supply plan details and specifications of the new product to be used to the POC and the ENV-PPA Project Manager.

- The Engineer shall evaluate all of the construction products proposed to be used within the SGMP contamination zone for their compatibility with the contaminated media. If the construction products proposed are not compatible, then the Engineer shall design an alternative product to be used. The alternative product shall be evaluated for cost, reliability/life cycle, ease of installation and use, and accessibility for procurement.
- The Engineer shall evaluate all potential multi-medial migration pathways that may be altered or created by constructing the improvements. This will include all vertical and horizontal pathways. Examples of horizontal pathways may be a graded drain through a groundwater plume or gasses migrating along a pipe chase. Examples of a vertical pathway may be a bridge pier installation through multiple confining layers. If the evaluation indicates a potential pathway issue, the Engineer shall design method(s) to prevent migration of any contamination or potentially contaminated media along or through the construction improvement.

221.3.7 Environmental Specialist – The Engineer/Technical Specialist shall detail the requirements for the Contractor to use an Environmental Specialist to manage the requirements outlined within the SGMP. The Engineer/Technical Expert shall include a bulleted list of duties that the Environmental Specialist will be required to perform including a time schedule to complete the activities. At a minimum, the following items shall be listed within this section as requirements for managing and using the Environmental Specialist.

- The contracted personnel used for the onsite Environmental Specialist shall be billed at a rate no greater than a Field Technician. The contracted rates shall be negotiated between the Contractor and TxDOT prior to work commencing on the project.
- The Environmental Specialist shall have at least two verifiable years performing the work outlined within the SGMP (preferred). The verifiable proof shall be reviewed and accepted by TxDOT prior to the work commencing on the project.
- The Environmental Specialist shall have the 40-hour Hazardous Waste Operation and Emergency Response (HAZWOPR) training.
- The Environmental Specialist shall be employed by a firm or organization that employs a professional(s) who holds a registration in one (1) or more of the following: Professional Engineer by the State of Texas, Registered Environmental Manager/Registered Environmental Professional by the National Registry of Environmental Professionals, Professional Geoscientist by the State of Texas, or a TCEQ-registered Corrective Action Project Manager (if applicable).

221.3.8 Revisions to the SGMP – The Engineer shall include a sub-heading within the SGMP that outlines the requirements to make corrections or updates to the SGMP.

221.3.9 The Engineer/Technical Expert shall include as an Attachment(s) separate process flow charts, one process per sheet, for each potentially contaminated media (soil, groundwater, atmospheric, etc.). Each process flow chart shall graphically depict the method for handling the specific contaminated media from discovery to final disposition (example: the steps and decisions that must be followed to handle contaminated soils).

221.4 Field Documentation and Reporting – The Engineer shall include a section within the SGMP that outlines the field documentation and reporting that is required to be submitted to TxDOT at the close of the project. At a minimum, the following field documentation and reporting should be included in the SGMP:

- SGMP Acceptance – Include an Attachment that provides for written documentation from the Contractor, Sub-Contractor(s), Environmental Specialist, and all personnel working within the SGMP zone to verify that they have read the SGMP and understand the contents. The initial SGMP Acceptance form shall be signed and dated prior to work commencing on the project. The SGMP Acceptance form is to be re-signed and delivered to TxDOT when changes to the plan or workers are made.
- Field logs and daily activities summaries – The Environmental Specialist shall submit daily activity summaries to the Contractor and TxDOT to verify work performed and time allocation (can be e-mailed). A field log shall be kept for the entire project and submitted to TxDOT at the end of the project by the Contractor.
- A SGMP final report shall be developed by the Environmental Specialist and submitted by the Contractor at the construction project completion. The final report shall contain, at a minimum:

- Daily field logs;
- All laboratory results with sample locations;
- All corrections and revisions to the SGMP;
- Disposal manifests;
- Personnel and company responsible for managing the SGMP, including names and certifications; and
- All other items related to the regulatory handling of the contaminated media, per the SGMP.

**WORK REQUEST THIRTEEN:  
INVESTIGATION OF PROBLEMS WITH RAMP BEARING  
ASSEMBLIES AND POSSIBLE SOLUTIONS AT THE PORT ARANSAS  
FERRY RAMPS**

**TASK 1 REPORT: RESEARCH AND INVESTIGATION**

During this task, we made a site visit to the Port Aransas Ferry and gathered information related to the performance of the ramp bearing assemblies and made measurements needed to install the instrumentation system. The data acquisition system needed for Task II was ordered. We met with both Port Aransas Ferry staff and TxDOT Bridge staff to gather information on their needs and begin gathering information on those needs.

We designed the data acquisition system to be installed on Ramp #1 on at the Port Aransas side landing. This ramp is heavily used and was convenient to access to electrical supply and fiber optic for internet connection to be used in the data acquisition. We made arrangements with the staff at the Corpus Christi District and the Ferry System to use their small portable building located between Ramps 1 and 2 to house the acquisition system. The Corpus Christi TxDOT staff installed the electrical supply and fiber optic connection needed.

We preassembled the wiring harness and data acquisition system with strain gages installed in the laboratory and tested the system for several days prior to the June installation in Port Aransas.

**TASK 2 REPORT: INSTALL INSTRUMENTATION AND MONITOR**

We gathered all needed materials and made arrangements with Ferry Operations to install the instrumentation within their schedule. TTI began installation of the acquisition system at Ramp #1 on the Port Aransas ferry landing on the week of June 15–18. After initial installation, we stayed on site for another 24 hours to monitor the data acquisition. We made arrangements with TxDOT to utilize TxDOT's internet access to remotely access the laptop that remained onsite that contained the acquisition software capable of making adjustments to data collected (frequency of sampling and what data written to the hard drive). This software allowed for the adjustment of excitation of input voltage and other variables for the strain gages of to adjust the data collected.

We made observations of the data being reported by the system during the next 10 days and determined the necessary triggers that would cause the software to write data to the hard drive of the laptop that would be useful and meaningful. After downtime for Hurricane Alex and a few attempts to collect meaningful data, we readjusted the triggers on July 8 and began collecting good data. We are still collecting data at this point to get at least 1 month of data as required in this task. We completed the month-long data collection effort in early August. The data acquisition system was removed in early October to make way for landing renovations, and we have finished analyzing the data to find the meaningful trends and results.

### **TASK 3 REPORT: RETRIEVE DATA**

We are gathering data directly through the internet so we do not need to make any trips onsite in Port Aransas to retrieve data. Data gathering has concluded.

### **TASK 4 TECHNICAL MEMORANDUM: ANALYZE DATA—RESEARCH ALTERNATE DESIGNS/DETAILS/SYSTEMS**

#### **Introduction**

##### *Objective*

The objective was to obtain field measurements of stringer longitudinal forces transmitted to ferry ramp support bearings.

##### *Background*

Several of the headwall bearing support assemblies for ramp stringers at the Port Aransas, TX, ferry have sustained damage in the form of fatigue cracking in welded connections. [Figure 29](#) shows a photograph of a cracked bearing assembly. Given the location and orientation of the cracks in the bearing assemblies, it is likely that longitudinal forces in the stringers are the cause of the damage.

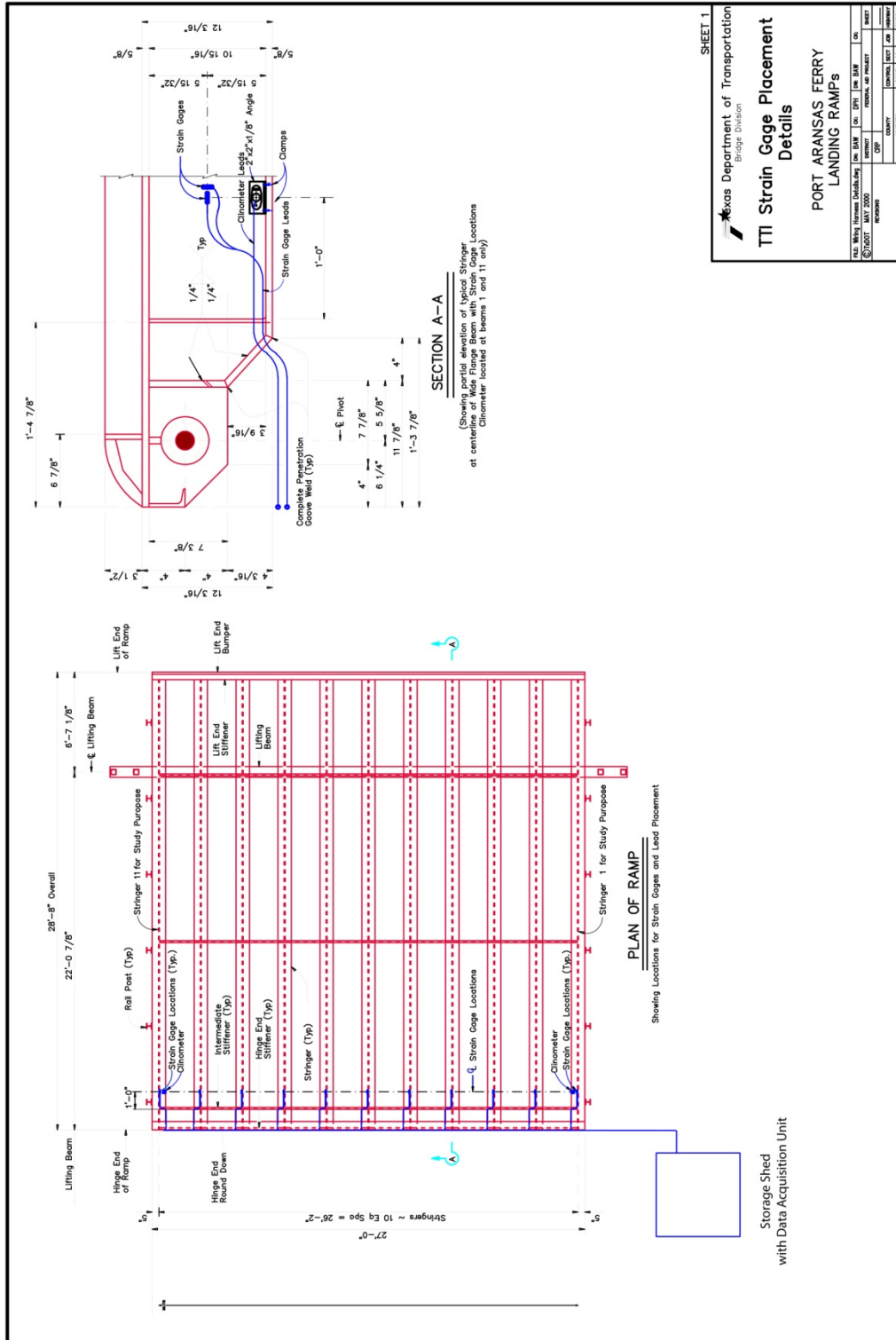


**Figure 29. Photograph of Cracked Bearing Assembly.**



### *Overview of Ramp*

A ferry ramp at Port Aransas serves two purposes. It is a bridge that vehicles cross to enter and leave the deck of a ferry boat, and it is also the mooring, or docking, device that holds a ferry boat in a proper and stable position relative to the headwall. [Figure 30](#) shows a drawing of the overall layout of a typical ramp at the Port Aransas facility. As shown in [Figure 30](#), the main structural system of a typical ramp comprises 11 longitudinal stringers each of which is supported at the headwall by a hinged bearing assembly; see [Figure 30](#) inset and [Figure 29](#). Near the other end of the ramp, the stringers are supported by a transverse beam that is suspended by cables that are wound around the drum of a winch. To raise and lower the ramp, thereby facilitating docking and undocking of a ferry boat, a technician operates an electric motor that drives the winch drum. When a boat is docked, the stringers are supported by a transverse beam that “hooks” over attachment points on the deck of the boat. When docked, vertical support of the ramp end is provided by the boat, with the cables on the winch in a slackened state.



**SHEET 1**

Texas Department of Transportation  
Bridge Division

**TTI Strain Gage Placement Details**

PORT ARKANSAS FERRY  
LANDING RAMP

|          |                   |          |       |
|----------|-------------------|----------|-------|
| DATE     | BY                | CHKD     | APP'D |
| 07/20/17 | WJG               | WJG      | WJG   |
| REV      | DESCRIPTION       | DATE     | BY    |
| 1        | ISSUED FOR PERMIT | 07/20/17 | WJG   |
| 2        | REVISED           | 07/20/17 | WJG   |

Figure 30. Structural Layout of Typical Ferry Ramp and Location of Instrumentation.

## *Loading of Ramp*

There are five cases of loading for a ramp at Port Aransas.

- Case 1: The ramp is suspended by the cables. In this case, the ramp is not holding a ferry in position, and no vehicles are crossing the ramp. Any transverse and longitudinal loads on the ramp are from self-weight only.
- Case 2: A ferry boat is in the process of docking. In this case longitudinal impact forces can be imposed on the ramp because of the momentum of the boat arriving at the ramp, wind and wave induced motion of the boat, and/or the thrust of the boat's engines that must be resisted to arrest the movement of the boat and permit attaching the ramp.
- Case 3: A ferry boat is docked at the ramp, the boat's engines are not providing thrust, and no vehicles are crossing the ramp. In this case, longitudinal forces can be imposed on the ramp because of wind and waves that cause the boat to move.
- Case 4: A ferry boat is docked at the ramp, and vehicles are crossing the ramp. In this case transverse forces are imposed on the ramp because of the weight of vehicles. In addition, longitudinal forces can be imposed on the ramp because the weight of the moving vehicles causes the boat to move, and also because wind and waves might be present that cause the boat to move.
- Case 5: A ferry boat is in the process of undocking. In this case longitudinal impact forces can be imposed on the ramp because of wind and wave induced boat movement and/or the thrust of the boat's engines that might engage before the ramp is fully released.

## **Experimental Procedures**

### *Overview of Experimental Program*

Because the damage apparent in [Figure 29](#) is most likely caused by longitudinal forces in the ramp, a system was designed and installed that could be used to infer the longitudinal forces in the stringers over a period of one month of normal operation of an active ramp. Specifically, strain gages were attached at the neutral axis of each stringer, near the headwall bearing, in an active ramp: see [Figure 30](#) inset. The gages were oriented to measure the axial strain in the stringers. Assuming elastic deformation of the stringers, the axial stress in the stringers was estimated by multiplying the measured axial strain by the elastic modulus of steel, 30,000 ksi. The axial force in the stringers was estimated by multiplying the axial stress by the cross sectional area of each stringer. A data acquisition system was assembled to collect data remotely during the month selected to observe the ramp.

### *Installation of Strain Measurement System*

Installation of the instrumentation required 8 steps as listed below. (Prior to installation, the sensors were preassembled and attached to their cables in the researcher's laboratory.)

- Step 1: Grating panels at the end of the ramp were removed to permit access to the ends of the stringer.

- Step 2: Paint and galvanization were ground away to expose bare metal at the measurement point for each stringer.
- Step 3: Strain gages were attached to each stringer.
- Step 4: Rust-resistant primer was applied to recover the exposed metal at the site of each sensor.
- Step 5: Rust-resistant paint was applied over the primer at the site of each sensor.
- Step 6: Cabling was routed to an out-building that housed the data acquisition system.
- Step 7: The instruments were connected to the data acquisition system.
- Step 8: The data acquisition system was initialized and brought online so that it could be accessed remotely.

Figures 31 through 42 are photographs illustrating the installation process.



**Figure 31. Photograph of Deck Panel Being Removed at End of Ramp.**



**Figure 32. Photograph of Instruments with Cables Attached Ready to be Installed.**



**Figure 33. Photograph of Positioning Marks at Each Sensor Location prior to Grinding.**



**Figure 34. Photograph of Sensor Locations after Grinding.**



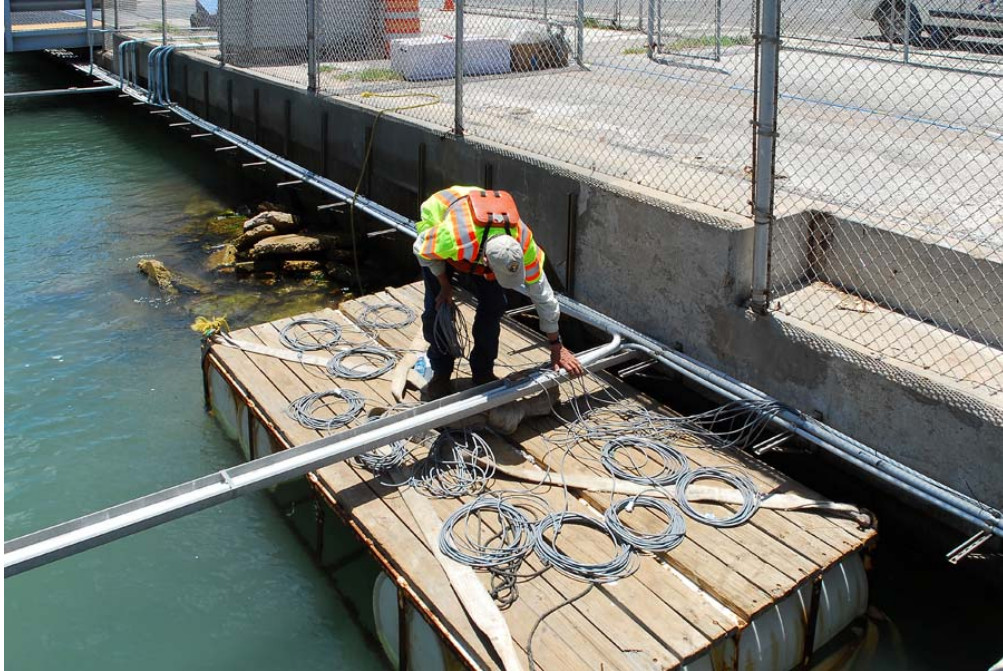
**Figure 35. Photograph of Typical Sensor as Installed.**



**Figure 36. Photograph of Sensor Installation after Priming and Painting.**



**Figure 37. Photograph of Stringer Ends after All Sensors Installed.**



**Figure 38. Photograph Showing Cable Being Bundled and Routed from Ramp to Out-Building.**



**Figure 39. Photograph Showing Cable Bundle Entering Out-Building.**





**Figure 40. Photograph Showing Data Acquisition System in Out-Building with All Sensors Installed and Operational.**



**Figure 41. Photograph of Deck Panel Being Replaced.**



**Figure 42. Photograph of Ramp at Completion of Sensor Installation.**

## **Experimental Results**

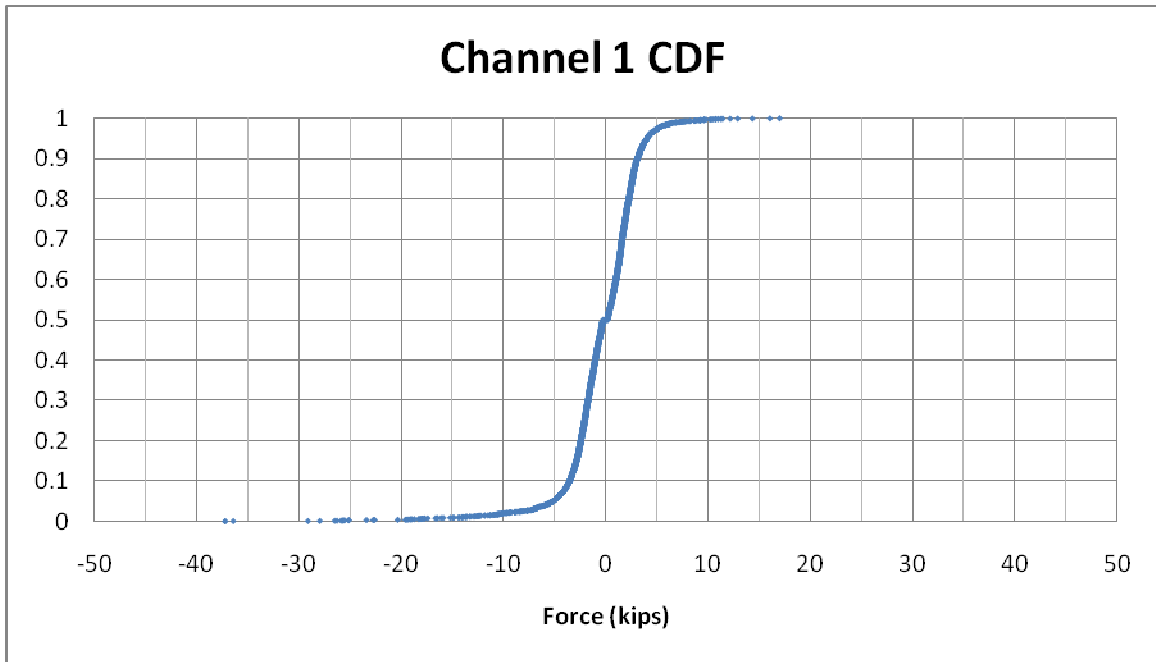
### *Explanation of Data Reduction*

The raw form of the experimental data comprises eleven channels of voltage signals generated by 120-Ohm strain gages arranged in a “poisson half-bridge” configuration: i.e., for each stringer, one active gage aligned with the axis of the stringer and a second perpendicular gage at the same location that deforms because of the Poisson strain. (Bridge completion resistors, also 120-Ohm, were installed as part of the data acquisition system.) The data acquisition system sampled these signals at a rate of 100 Hz, with a time skew of less than one micro-second between the first and last sampled channel, converted the analog signal to a digital signal, and recorded the signal to disk. A separate spreadsheet program was used to convert the digitized voltage signals into quantitative estimates of axial force as described in the procedures above.

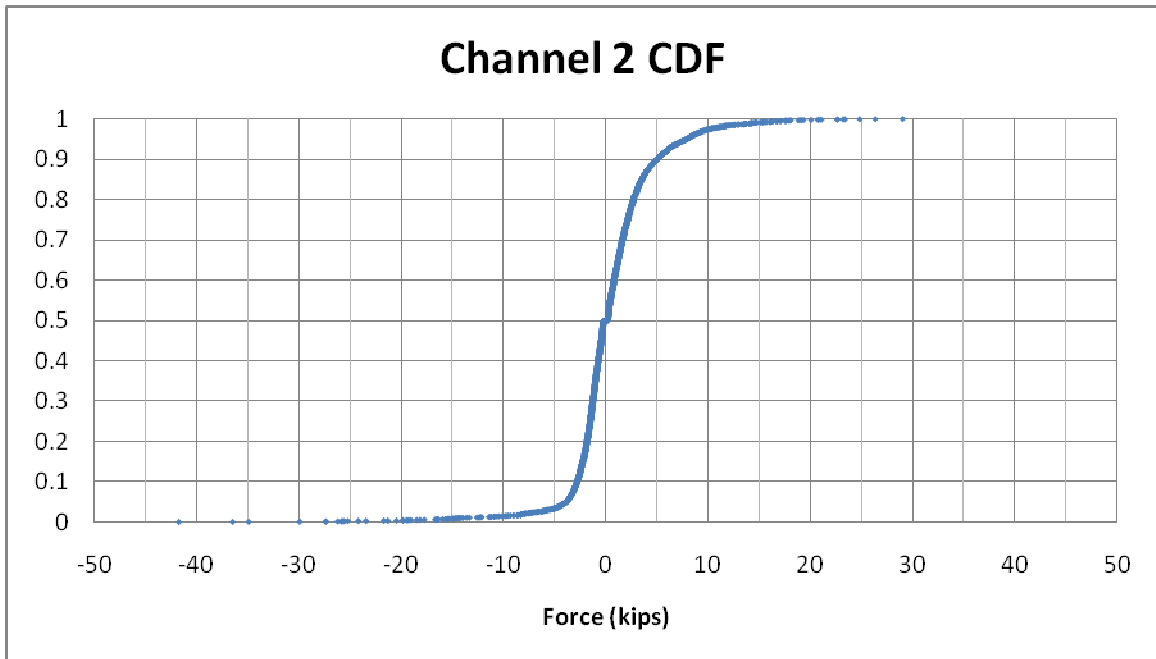
### *Presentation of Data*

The data from the measurements is presented in a form that preserves the essential stochastic characteristics of the data. Plots of the cumulative probability of stringer force are presented for each stringer below (Figures 43–53). The independent variable in these plots, the horizontal axis, represents the axial force in the stringer. The dependent variable, vertical axis, represents the percentile ranking of a given force value. Hence the force value with a ranking of 0.5 is the median force: i.e., 50 percent of the estimated forces were smaller than this value and

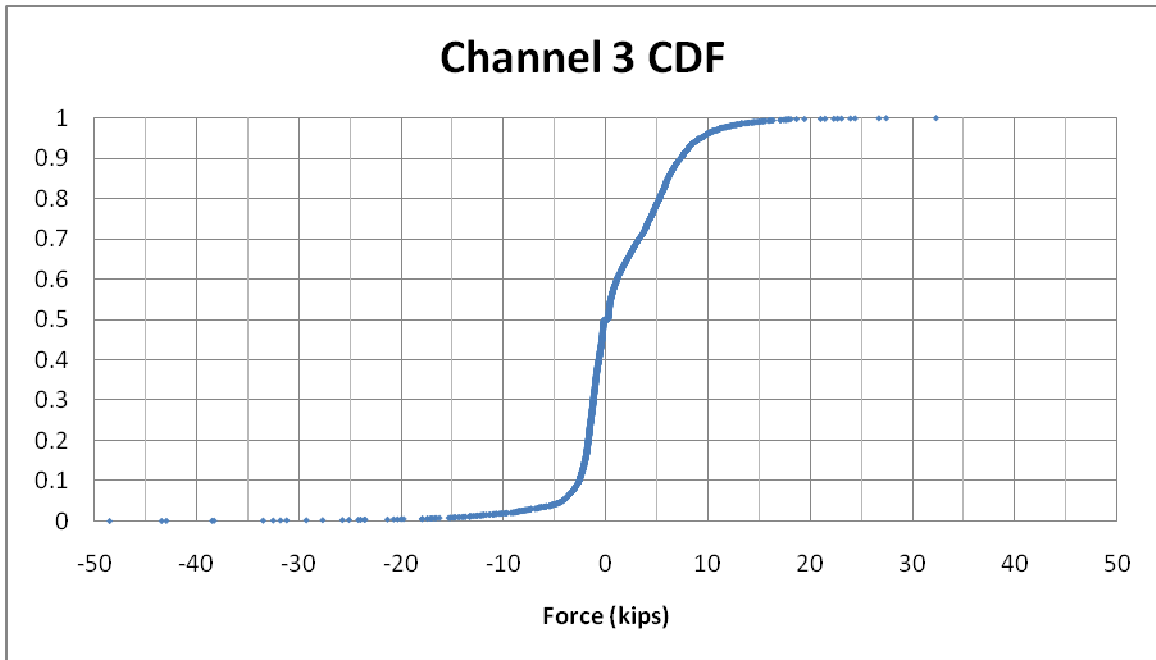
50 percent were larger. In addition to the plots of cumulative probability, [Table 25](#) presents a tabular summary of the force statistics for each stringer.



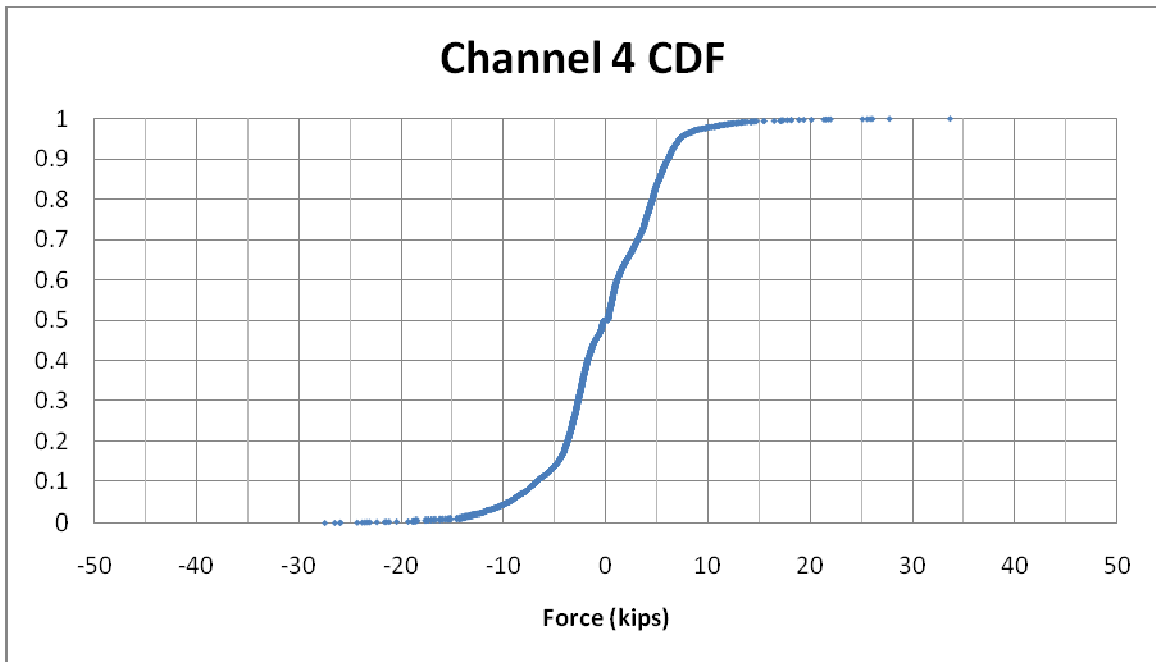
**Figure 43. Cumulative Distribution of Force in Stringer Number 1.**



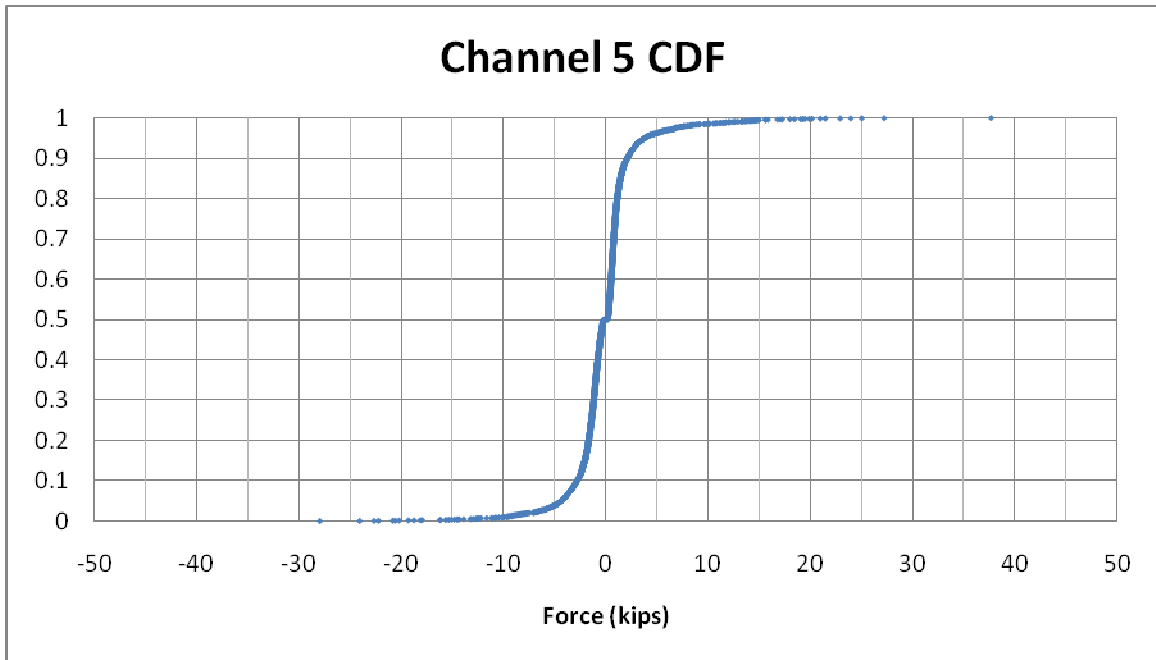
**Figure 44. Cumulative Distribution of Force in Stringer Number 2.**



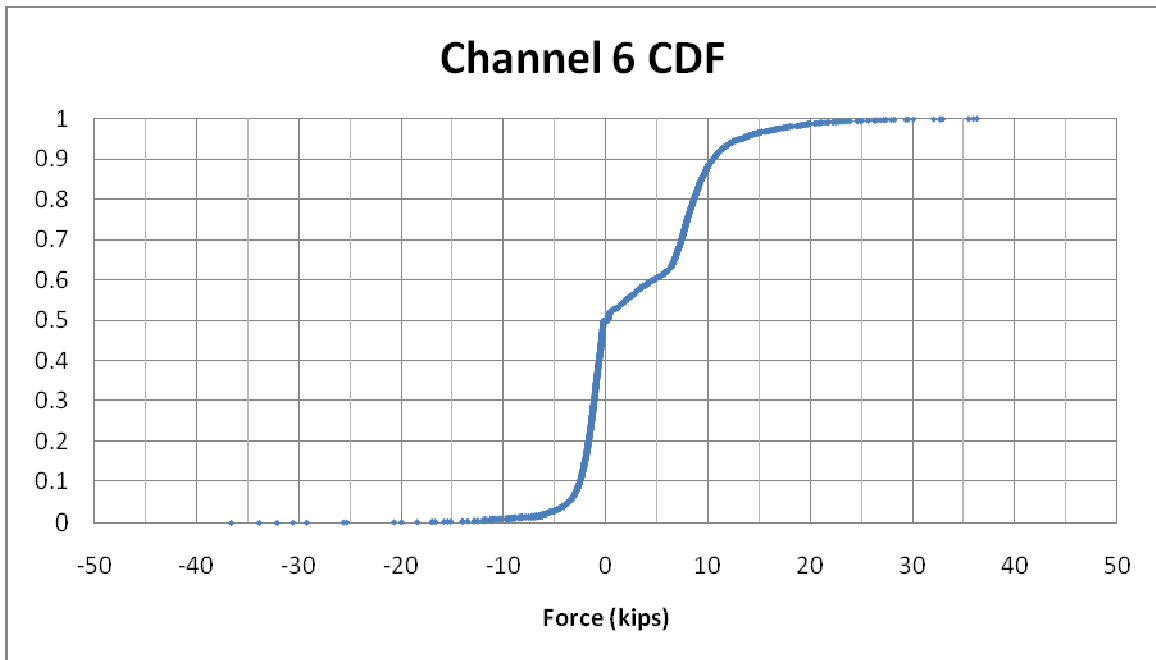
**Figure 45. Cumulative Distribution of Force in Stringer Number 3.**



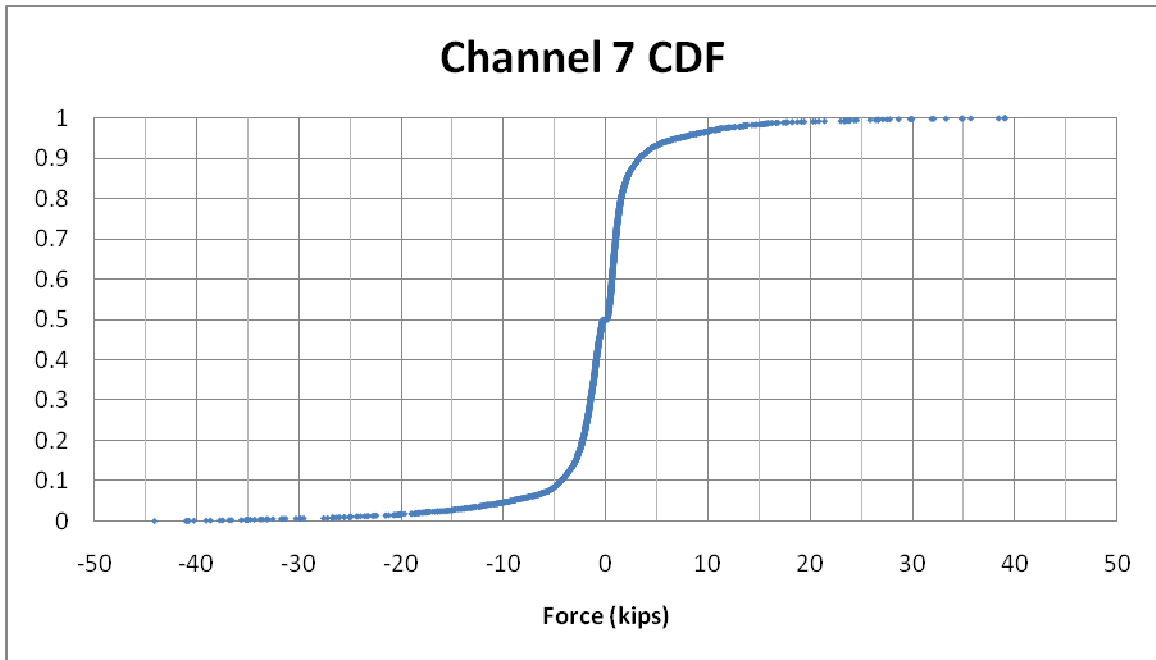
**Figure 46. Cumulative Distribution of Force in Stringer Number 4.**



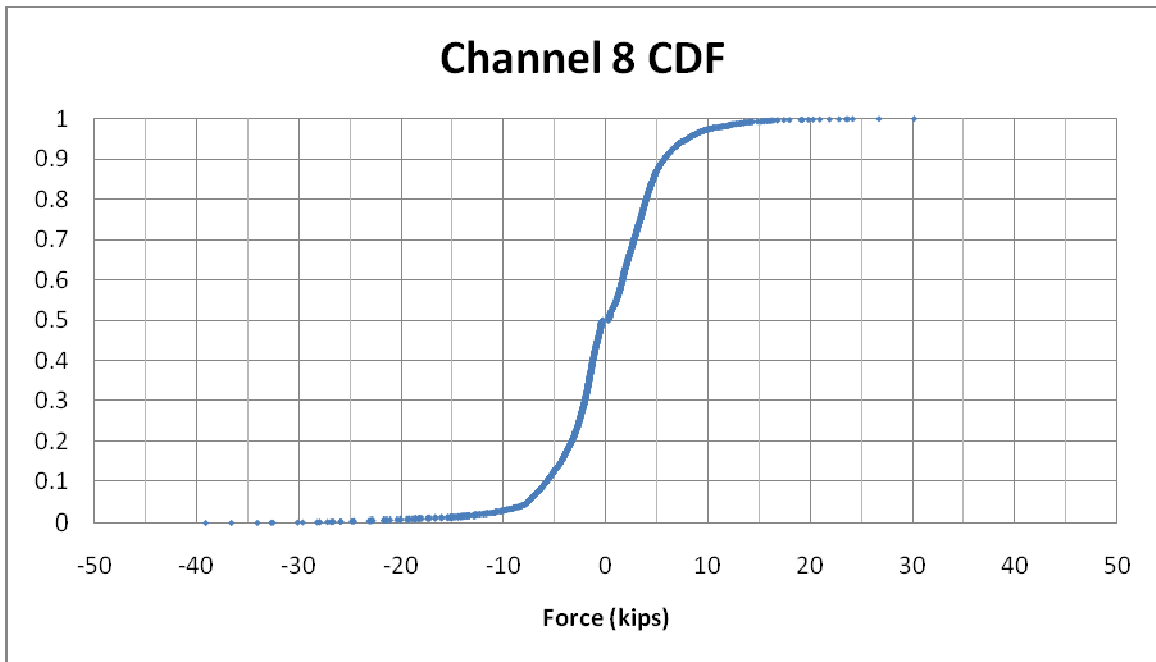
**Figure 47. Cumulative Distribution of Force in Stringer Number 5.**



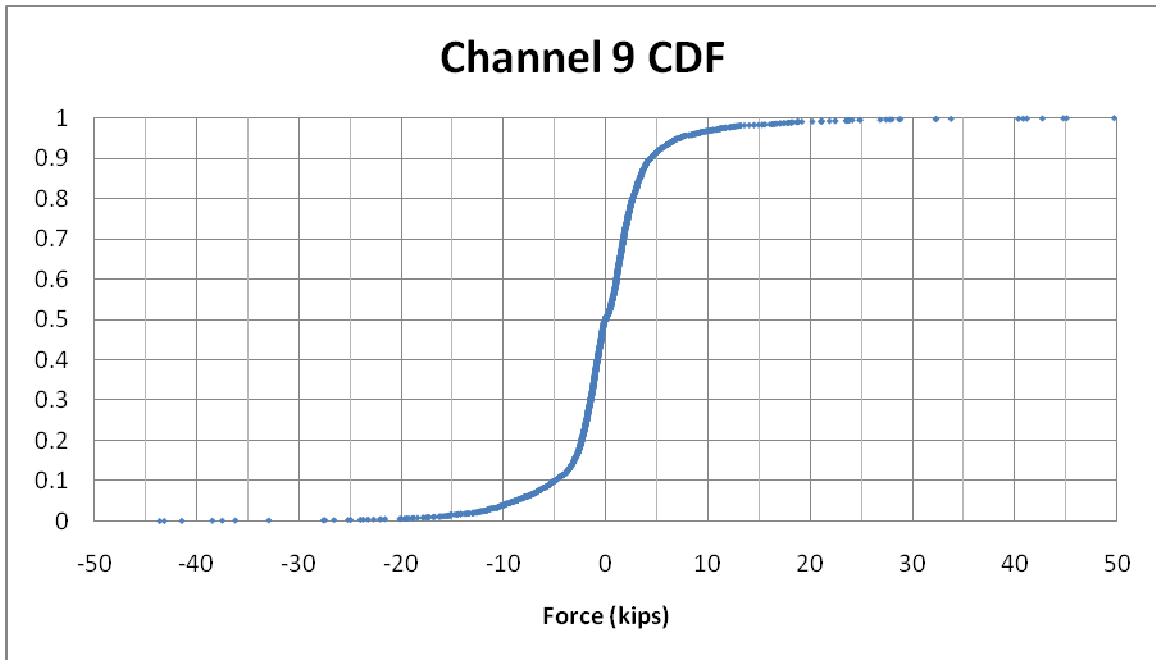
**Figure 48. Cumulative Distribution of Force in Stringer Number 6.**



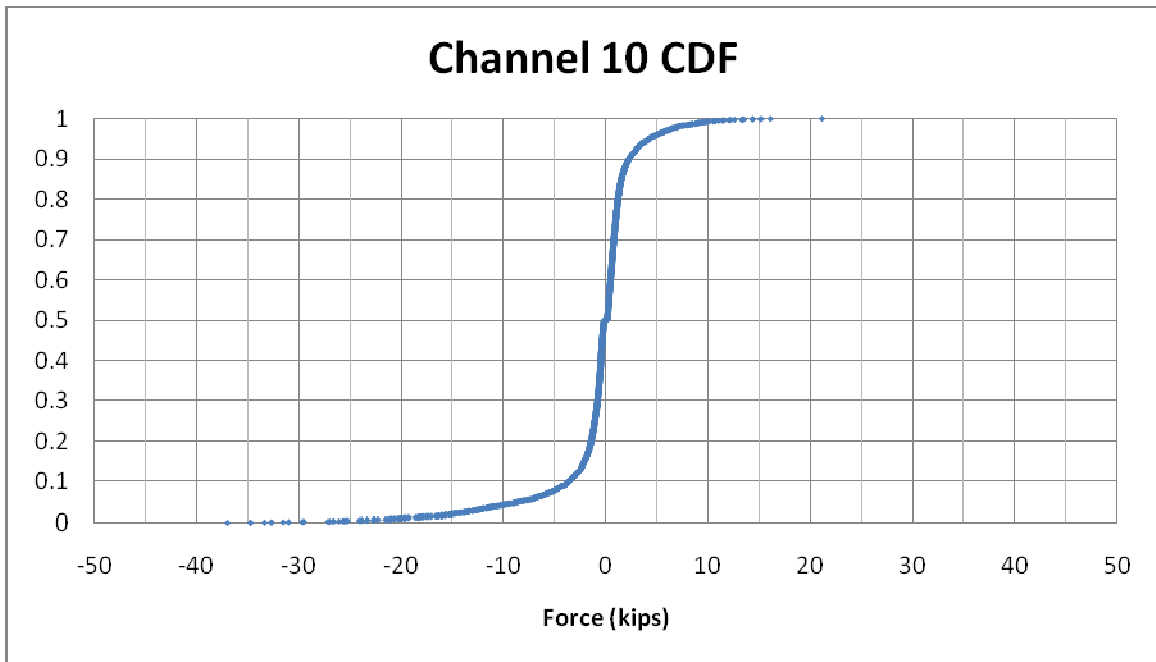
**Figure 49. Cumulative Distribution of Force in Stringer Number 7.**



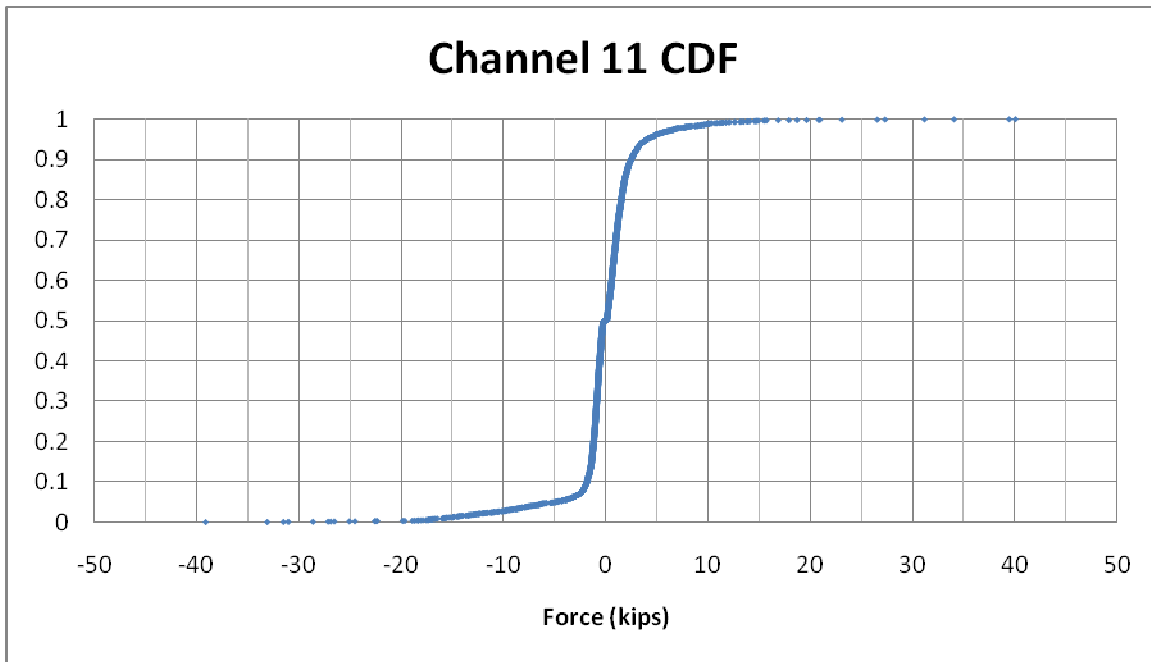
**Figure 50. Cumulative Distribution of Force in Stringer Number 8.**



**Figure 51. Cumulative Distribution of Force in Stringer Number 9.**



**Figure 52. Cumulative Distribution of Force in Stringer Number 10.**



**Figure 53. Cumulative Distribution of Force in Stringer Number 11.**

**Table 25. Statistical Summary of Stringer Forces.**

| Stringer | Mean  | Min    | Max   | 95% Interval |       | 99% Interval |       |
|----------|-------|--------|-------|--------------|-------|--------------|-------|
| 1        | -0.28 | -37.16 | 17.04 | -8.15        | 5.13  | -18.94       | 9.26  |
| 2        | 0.49  | -41.71 | 29.02 | -6.65        | 10.06 | -18.55       | 17.06 |
| 3        | 1.13  | -43.46 | 32.26 | -8.31        | 11.19 | -18.26       | 17.03 |
| 4        | -0.12 | -27.51 | 33.72 | -11.80       | 9.43  | -18.58       | 17.12 |
| 5        | -0.15 | -27.91 | 37.65 | -6.46        | 6.83  | -13.31       | 14.92 |
| 6        | 3.10  | -36.63 | 36.31 | -5.34        | 16.76 | -12.59       | 25.66 |
| 7        | -0.46 | -44.12 | 39.12 | -15.58       | 11.66 | -33.04       | 25.97 |
| 8        | 0.09  | -39.11 | 30.15 | -10.64       | 10.15 | -22.93       | 16.01 |
| 9        | 0.01  | -44.21 | 49.68 | -12.10       | 11.38 | -22.04       | 24.52 |
| 10       | -0.59 | -36.96 | 21.15 | -13.56       | 6.38  | -23.93       | 10.77 |
| 11       | -0.04 | -39.05 | 40.11 | -10.87       | 6.78  | -17.56       | 14.20 |

### Conclusions

- 1) Maximum stringer force magnitudes exceed 45 kips.
- 2) Forces within the 99<sup>th</sup> percentile range exceed 25 kips in magnitude.
- 3) Stringer forces are roughly balanced between being tensile and compressive displaying median values of nearly zero magnitude.
- 4) Strain measurements from this study indicate that the bearing assembly connections at the headwall of the ramp experience a fully-reversed fatigue loading involving force magnitudes in excess of 45 kips.



**Recommendations**

- 1) Look at possible design changes and modifications for the existing connections of the ramp assemblies to the landing that can accommodate an energy dissipation system such as a dashpot.
- 2) Or redesign and modify the existing connections from the ramp assembly to landing to accommodate the forces and stress reversal experienced by the connections.



# **WORK REQUEST FOURTEEN: ALTERNATIVE FUELS SCANNING PROJECT: ELECTRIC VEHICLE LITERATURE REVIEW SUMMARY**

## **INTRODUCTION**

### **Alternative Fuels Scanning Project Scan Summary**

Over 300 top-tier media market news articles have been reviewed in depth during this quarter. Since the inception of this project, Vocus—an online media monitoring service—has collected over 12,000 articles. A subset of 300 articles was chosen based on content and publication. The remaining articles collected were briefly scanned, as some include redundant information. Over 75 websites have been reviewed; a list of links will be made available on the blog in October. The Electric Vehicle (EV) Project website is monitored weekly, along with a selection of approximately 20 additional websites related to alternative fuel vehicles and alternative energy.

A review of Peer State electric and hybrid vehicle incentives was conducted and is included at the end of this report. A list of major participating stakeholders by region will be completed and posted to the blog in October.

### **Electric Vehicle Projects**

In the United States, new electric vehicle and technology projects seem to emerge monthly. On August 5, 2010, President Obama announced \$2.4 billion in grants, which were awarded to 48 projects across the United States under the American Recovery and Reinvestment Act. The projects awarded were selected through the competitive process under the Department of Energy. Expectations are that these key projects will accelerate the development of U.S. manufacturing capacity for batteries and electric drive components as well as the deployment of electric drive vehicles.

Go to: <http://bit.ly/aJeyeK> for all the information related to this award, including projects and locations.

### **Funding/Support**

- \$2.4 billion in grants, primarily funded by the U.S. Department of Energy. This is new funding, separate from The EV Project.
- Over 75 research and/or implementation projects across the United States since August 2009.
- The EV Project started with a \$99.5 million grant awarded by the Department of Energy and kicked off in October 2009. An additional \$15 million was added in June 2010.
- The *Electric Vehicle Initiative* (EVI) is a worldwide effort to implement electric vehicles. Countries actively participating include China, France, Germany, Japan, South Africa, Spain, Sweden, and the United States.

- China announced investing 100 billion yuan (\$14.7 billion U.S.) over next 10 years (2011–2020) with an annual production goal of 500,000 alternative fuel vehicles (AFVs) starting in 2011
- Great Britain, although not a member of the EVI, is implementing EV infrastructure as well.

### **Projections**

- Sales of hybrid and electric vehicles could top 3 million nationwide by 2015. *J.D. Powers and Associates.*
- 20 million electric vehicles are estimated worldwide by 2020. *International Energy Administration.*
- Ford Motor Company plans to introduce five new electric vehicle models by 2013. Ford also anticipates electric-hybrid vehicles (HEV), plug-in electric vehicles (PHEV), and battery-electric vehicles (BEV) will represent 2–5 percent of their global fleet by 2015, rising to 10–25 percent by 2020. *Ford Motor Company.*

### **Demonstration/Implementation Projects**

- The EV Project in the United States is the largest implementation project worldwide, installing over 15,000 charging stations in five states—including Texas.
- Charging stations are being installed, currently in few numbers, in parking garages and businesses for employees to plug in to. It is anticipated quick charge stations, offering an 80% capacity charge of an EV in 20–30 minutes, will be installed in convenient locations where people are stopping over for an hour such as a Starbucks, grocery stores, and malls. The downtown Austin Whole Foods Market has an EV charging station, one of the first installed in Texas.

### *Commercial*

- FedEx’s current fleet
  - 300 electric hybrids
  - 1,800+ worldwide
- UPS
  - Fleet of 250 electric hybrid delivery trucks
    - 25 are located in Stafford, Texas
- AT&T
  - Invests \$565 million for 15,000 alternative fuel vehicle fleet in 10 years

### *Consumer Use of Commercial Services*

- Taxis

- Taxis across the nation are converting to hybrid vehicles
- Rental Car Companies
  - Enterprise
    - Largest hybrid fleet
    - Available in cities across the United States including Austin, Dallas, and Houston
    - Rolling out 500 EVs in select markets

### *Government*

- Federal Government
  - United States Postal Service
    - Awarded \$2 billion to convert 20,000 vehicles to electric over 3 years, by 2013
- Municipalities, state agencies, and universities across the nation are designating minimum percent in their fleet purchases and identifying vehicles for conversion to liquefied natural gas (LNG), compressed natural gas (CNG), or other alternative fuels as applicable.

### *Consumer*

- The EV Project
  - Five states, 16 cities

### **Findings**

- Alternative Fuel Vehicles, including electric vehicles, are reaching the tipping point. Funding for research, infrastructure, and technology is abundant. Governments and industry, worldwide, are creating the market based on the need to develop alternative energy sources in advance, not based on consumer demand. Consumer demand is considered secondary, much like the old adage from the movie *Field of Dreams*, “If you build it, they will come,” and consumers are lining up to purchase according to primary electric and alternative fuel vehicle manufacturers Nissan, Chevrolet, and Ford.

### **Challenges**

- Among key challenges that prevent rapid market penetration of electric vehicles is:
  - lack of infrastructure,
    - at home at around town
  - range anxiety, and
  - cost;

- however, manufacturers of the vehicles provide incentives such as \$5000 rebates for installation of a home charging unit.

Future updates and summary reports will be delivered through an electronic format. The electronic blog platform will enable timely updates as well as providing information that is easily accessed and shared among members of the Alternative Fuel Scanning project.

The Alternative Fuel/Electric Vehicle Scan Blog at:  
<http://electricvehiclescanproject.wordpress.com/about/>

## **SUMMARY OF ELECTRIC VEHICLE USE STATUS**

Major corporations and individual investors seek to be at the forefront of what they see as the next major global and environmental investment—electric and alternative-fuel vehicles. Corporations like Intel, GM, Ford, MicroSoft, UPS, Nissan, and FedEx—to name a few—are leading the charge of President Barack Obama’s electric vehicle provisions in the federal fuel economy and emissions rules announced on April 1, 2010 (<http://www.epa.gov/oms/climate/regulations.htm>). The fuel economy rules, which set the U.S. auto industry standard at 35.5 miles per gallon (mpg) average by 2016, sent many automakers and industry leaders back to their plants to put their electric vehicle (EV) projects on the fast track. Automakers are investing in necessary facilities, and many plan to have at least one all-electric model on the road by 2011. Ford and Nissan are leading the way with models currently in production.

One of the challenges of EVs becoming mainstream is the lack of infrastructure. The U.S. Department of Energy announced on August 5, 2009, that the largest deployment plan in the world of EVs and EV infrastructure would be awarded to the Electric Transportation Engineering Corporation (eTec), a subsidiary of ECotality, Inc. The \$99.8 million grant, awarded on October 1, 2009, officially marked the launch of The EV Project (<http://theevproject.com>). According to The EV Project website, “eTec is partnering with Nissan North America to deploy up to 4,700 zero-emission electric vehicles, the Nissan LEAF and 11,210 charging systems to support them in strategic markets in five states: Arizona, California, Oregon, Tennessee, and Washington.”

The website goes on to explain that The EV Project will “collect and analyze data to characterize vehicle use in diverse topographic and climate conditions, evaluate the effectiveness of charge infrastructure and conduct trials of various revenue systems for commercial and public charge infrastructure. The ultimate goal of The EV Project is to take lessons learned from deployment of these first 4,700 EVs, and the charging infrastructure to support them, to enable the streamlined deployment of the next 5,000,000 EVs.”

The EV Project plans to deploy charging infrastructure in the following major population areas during summer 2010: Phoenix and Tucson, Arizona; San Diego, California; Portland, Eugene, and Corvallis, Oregon; Seattle, Washington; and Nashville, Knoxville, and Chattanooga, Tennessee. The Nissan LEAF will be available in fall of 2010 to consumers and fleets in those same areas.

## FOCUS REVIEW AREAS

As noted earlier in this report, the project team identified and categorized findings from the literature search into Focus Review Areas, which are listed below. The organization of the Alternative Fuel/Electric Vehicle Scan Blog will follow a similar category structure in which articles, news, and resources will be filed and easily accessed by review area. In addition, the articles will be tagged with keywords such as Smart Grid, commercial, consumer, charging station, emissions, SAE, repurposed vehicle, battery technology, and other relevant terms that will be identified as the project continues.

Focus Review Areas identified in the initial scan are as follows:

- Policy
- Infrastructure
  - Current research
  - Modes of recharge (plug-in, solar, charging station)
  - Current (e.g., Central Market in Austin charging station)
  - Planned
- Market projections published or available
- Planned and deployed demonstration projects
  - Consumer projects
  - Commercial projects
    - FedEx, UPS
  - Government projects
    - Federal
    - State
    - City
- Vehicle Performance
  - Vehicle statistics related to consumer and commercial markets
  - List of top vehicle manufacturers, consumer and commercial
  - Range
  - Speed, acceleration
  - Production estimates, timelines
  - Batteries
- Areas of implementation
  - UPS – 200 hybrid electric vehicles deployed in Austin, Houston, Philadelphia, Chicago, Washington D.C., Long Island, Minneapolis, and Louisville. Prior to

launch of the recent 200 deployed, UPS was operating 50 hybrid electric vehicles as delivery trucks in Atlanta, Dallas, Houston, and Phoenix.

- Market leader decisions, opinions and quotes
  - Vehicle industry
  - Market penetration predictions
  - Commercial vehicle industry
  - Oil industry
- Energy
  - DOE, other energy leaders to be identified
  - Current investments/partnerships in technologies
- Government initiatives, public/private organizations, partnerships (e.g., Microsoft/Ford partnership), private/university partnerships
- Infrastructure
- Committees and interest groups
  - Transportation Research Board (TRB)
  - Society of Automotive Engineers (SAE)
  - National Highway Traffic Safety Administration (NHTSA)
  - Public Utility Commission of Texas
    - Electric Vehicle (EV) Utility Stakeholder Group Workshop – May 12, 2010; TTI invited to attend
  - Identify other interest groups

## COMMON ACRONYMS

The following list defines acronyms used frequently in relationship to electric and electric/hybrid vehicles.

**EV:** An electric vehicle, a vehicle that runs on electricity stored onboard in a battery pack.

**FCEV:** A fuel-cell electric vehicle, a vehicle with electric motors powered by energy from a fuel cell rather than from a battery pack, though most FCEVs have small battery packs as a buffer for extra acceleration and to absorb energy during regenerative braking.

**HEV:** A hybrid-electric vehicle, a vehicle that combines an internal-combustion engine with an electric motor. There are many sub-types of HEVs; see other entries on this page with “HEV” or the word “hybrid” in them for examples.

**LEV:** Low-emission vehicle, a vehicle that produces an emissions level that meets the LEV standard defined in California Low-Emission Vehicle regulations.



**NEV:** A neighborhood electric vehicle, an electric vehicle with top speed limited to 20–25 mph that is legal in many states on streets with a posted speed limit of 25–35 mph or less.

**PHEV:** A plug-in hybrid, a hybrid that can be plugged in to recharge from a wall plug or other utility-provided electricity instead of generating all its electrical power onboard from gasoline. Such a vehicle can run using less gasoline than a non-plug-in hybrid, or even none at all, for much of a day’s driving. This attribute reduces petroleum use and pollution, at the cost of requiring provisions for external charging and a larger battery pack than an ordinary HEVs.

**SULEV:** Super-ultra-low-emission vehicle, an electric vehicle that produces emissions cleaner than the ULEV standard defined in California’s Low-Emission Vehicle regulations. SULEVs are the cleanest EVs short of a zero-emission vehicle.

**ULEV:** Ultra-low-emission vehicle, a vehicle that produces emissions cleaner than the LEV standard defined in California Low-Emission Vehicle regulations.

**ZEV:** Zero-emission vehicle, a vehicle that emits no tailpipe pollutants, such as a totally electric or fuel-cell vehicle.

## **TEXAS INCENTIVES**

*Source: alternative fuels and advanced vehicles data center*

### **Neighborhood Electric Vehicle (NEV) Access to Roadways**

NEVs are defined as vehicles that can attain a maximum speed of 20–25 mph and must comply with the safety standards in Title 49 of the Code of Federal Regulations, section 571.500. NEVs may only be used on roads that have a posted speed limit of 45 mph or less but may cross a road or street at an intersection where the road or street has a posted speed limit of more than 45 mph. A county, municipality, or the Texas Department of Transportation may prohibit the operation of a NEV on a street or highway if the governing body determines that the prohibition is necessary in the interest of safety. (Reference Senate Bill 129, 2009, and Texas Statutes, Transportation Code 551.301-551.303)

*Source: hybridcars.com*

- The City of Austin’s “Drive Clean--Park Free” program gives city-registered owners of hybrid vehicles that receive an EPA air pollution score of 8 or better a \$100 pre-paid parking cards to park in any of the city’s 3700 parking meters. Owners must submit an application to the city and receive a bumper sticker showing their participation in the program. Eligible vehicles must be purchased at certified dealerships within the Austin City Limits.
- The City of San Antonio allows owners of hybrid vehicles to park for free at street parking meters. A City ordinance, which took effect immediately after City Council approval on May 4, 2006, requires all owners wishing to take advantage of the 1-year pilot program to register their hybrid vehicles with the City’s Parking Division

located at 243 N. Center Street. Registered hybrid vehicle owners can park at any of the City's 2010 street parking meters without charge, including the pilot Pay & Display locations. All drivers must follow street parking meter rules such as parking for only the time allotted at the respective meter. For more information, call (210) 207-8266.

## **CALIFORNIA INCENTIVES**

*Source: alternative fuels and advanced vehicles data center*

### **Hybrid Electric Vehicle Purchase Vouchers**

Through the Hybrid Truck and Bus Voucher Incentive Project (HVIP), the California Air Resources Board provides vouchers to eligible fleets in order to reduce the incremental cost of qualified medium- and heavy-duty hybrid electric vehicles at the time of purchase. Vouchers are available on a first-come, first-served basis and range from \$10,000 to \$45,000. Only fleets that operate vehicles in California are eligible. Refer to the HVIP website for a list of qualified vehicles and other requirements.

### **Plug-In Hybrid and Zero-Emission Light-Duty Vehicle Rebates**

Rebates are available through the Clean Vehicle Rebate Project (CVRP) for the purchase or lease of qualified clean vehicles. The rebates offer up to \$5,000 for light-duty zero-emission and plug-in hybrid vehicles and up to \$20,000 for zero-emission commercial vehicles that are approved or certified by the California Air Resources Board (ARB) on a first-come, first-served basis. The rebates are available on a first-come, first-served basis to individuals, business owners, and government entities in California that purchase or lease new eligible vehicles on or after March 15, 2010. Eligible vehicles are electric drive cars, trucks, commercial medium- and heavy-duty vehicles, motorcycles, or neighborhood electric vehicles. Manufacturers of zero-emission vehicles must apply to ARB to have their vehicles included in CVRP. Refer to the CVRP website for a list of eligible vehicles and other requirements.

### **Alternative Fuel and Vehicle Research and Development Incentives**

The Alternative and Renewable Fuel and Vehicle Technology Program, established by Assembly Bill 118 and administered by the California Energy Commission, aims to increase the use of alternative and renewable fuels and innovative technologies. Grants and loans are available for projects that:

- develop and improve alternative and renewable low carbon fuels;
- optimize alternative and renewable fuels for existing and developing engine technologies;
- produce alternative and renewable low carbon fuels in California;
- decrease the overall impact of an alternative and renewable fuel's lifecycle carbon footprint and increase sustainability;
- expand fuel infrastructure, fueling stations, and equipment;

- improve light-, medium-, and heavy-duty vehicle technologies;
- retrofit medium- and heavy-duty on-road and non-road vehicle fleets;
- expand infrastructure connected with existing fleets, public transit, and transportation corridors; and
- establish workforce training programs, conduct public education and promotion, and create technology centers.

### **High Occupancy Vehicle (HOV) Lane Exemption**

Qualified compressed natural gas, hydrogen, electric, and hybrid electric vehicles (HEV) meeting specified California and federal emissions standards may use HOV lanes regardless of the number of occupants in the vehicle. Vehicles must be affixed with a Clean Air Vehicle sticker issued by the California Department of Motor Vehicles, which expire January 1, 2011. A limited number of Clean Air Vehicle stickers are available. Drivers of qualified HEVs registered to an address in the nine-county San Francisco Bay region must also obtain a Bay Area FasTrak account before using HOV lanes. For more information about qualified vehicles, see the California Air Resources Board Carpool Lane Use Stickers website (reference California Vehicle Code 5205.5 and 21655.9).

### **Alternative Fuel Vehicle (AFV) and Fueling Infrastructure Grants**

The Assembly Bill (AB) 2766 Motor Vehicle Registration Fee Program provides funding for projects that reduce air pollution from on- and off-road vehicles. Eligible projects include purchasing AFVs and developing alternative fueling infrastructure. Contact local air districts for more information about available grant funding and distribution from the AB 2766 Motor Vehicle Registration Fee Program (reference Health and Safety Code 44220 (b)).

### **Electric Vehicle (EV) Parking Incentive - Sacramento**

Sacramento offers free parking to individuals or small businesses certified by the city's Office of Small Business Development that own or lease EVs with an EV parking pass in designated downtown parking garages and surface lots. Free EV charging is also provided in several parking garages.

### **Alternative Fuel Vehicle (AFV) and Hybrid Electric Vehicle (HEV) Parking Incentive - Santa Monica**

The City of Santa Monica offers free meter parking for dedicated electric vehicles displaying the Zero-Emission Vehicle decal and compressed natural gas and HEVs displaying properly affixed California Clean Air Vehicle Decals. Vehicles may park free for the maximum time limit posted on the meter per trip.

### **Electric Vehicle (EV) Parking Incentive - Los Angeles Airport**

The Los Angeles Airport (LAX) offers free parking and charging for EVs in the lower/arrivals level of Parking Structures 1 and 6.

## **Alternative Fuel Vehicle (AFV) and Hybrid Electric Vehicle (AFV) Insurance Discount**

Farmers Insurance provides a discount of up to 10 percent on all major insurance coverage for HEV and AFV owners. To qualify, the automobile must be: (1) designed to use a dedicated alternative fuel as defined in the Energy Policy Act of 1992; or (2) an HEV. A complete Vehicle Identification Number is required to validate vehicle eligibility.

## **Electric Vehicle (EV) Charging Rate Reduction - SMUD**

The Sacramento Municipal Utility District (SMUD) offers a discounted rate of approximately 50 percent as compared to the regular residential rate for electricity used by residential customers to charge EVs. EV drivers must sign up for the appropriate residential time-of-use rate. SMUD also offers lower off-peak time-of-use rates for EV charging by commercial customers.

## **Electric Vehicle (EV) Charging Rate Reduction - LADWP**

The Los Angeles Department of Water and Power (LADWP) offers a discounted rate of \$0.025/kWh for electricity used to charge EVs during off-peak times. LADWP also provides guidance on EV infrastructure to help customers determine applications for EVs in their fleet operations, EV maintenance services, and training.

## **Electric Vehicle (EV) Charging Rate Reduction - SCE**

Southern California Edison (SCE) offers a discounted rate to customers for electricity used to charge EVs. Two rate schedules are available for EV charging during on- and off-peak hours.

## **Clean Vehicle Electricity Rate Reduction - PG&E**

Pacific Gas & Electric (PG&E) offers a discounted rate for electricity used to charge battery electric vehicles, plug-in hybrid electric vehicles, and natural gas vehicle home fueling appliances.

## **Electric Vehicle (EV) and Natural Gas Infrastructure Charging Rate Reduction - SDG&E**

San Diego Gas & Electric (SDG&E) offers discounted rates to customers for electricity used to charge EVs or qualified compressed natural gas fueling facilities. SDG&E's EV Time of Use (TOU) rate is available in three variations, all of which charge customers based on the time of day the energy is consumed. These TOU rates are non-tiered, and all SDG&E rates have four main components, notably the Residential Rate Tariff and the Electric Energy Commodity Rates. For more information about the rates and their components, see the SDG&E Electric Tariff website.

## **Low Emission Taxi Incentives - San Francisco**

The San Francisco Taxicab Commission has committed to reduce greenhouse gas emissions from the San Francisco taxi fleet by 20 percent by 2012, as compared to 1990 emissions levels. Under the Clean Taxi Program, companies may apply for a surcharge of up to

\$7.50 on any gate fee charged for the use of certain low emission vehicles. Additionally, grants of up to \$2,000 per vehicle may be available from the San Francisco County Transportation Authority toward the purchase of light-duty hybrid electric and compressed natural gas taxis.

### **Employee Vehicle Purchase Incentives - Riverside**

City of Riverside employees are eligible to receive a rebate toward the purchase of qualified natural gas or hybrid electric Advanced Technology Partial Zero-Emission Vehicles that are purchased from a City of Riverside automobile dealership. The rebate for a new qualified vehicle is worth up to \$2,000, or \$1,000 for a qualified used vehicle.

*Source: hybridcars.com*

- The Department of Motor Vehicles (DMV) is no longer accepting applications from drivers who own a Toyota Prius, Honda Civic, or older Honda Insight hybrids for carpool stickers. State law allowed the DMV to issue 85,000 stickers to certain hybrid drivers on a first-come, first-served basis. Spokesman Steve Haskins said that his agency had 700 applications over that level and no longer wanted motorists to send in an application. “We have no more stickers available to issue and any applications sent to DMV will likely not be successfully processed,” Haskins said. “Any unprocessed applications and checks will be returned as soon as the last of the stickers are mailed to customers.”
- California Gov. Arnold Schwarzenegger signed Assembly Bill 1500 on July 7, 2010, providing a perk that allows drivers of pure electric vehicles and cars running on compressed natural gas to drive solo in California carpool lanes until January 1, 2015. But the privilege was not extended to conventional hybrids. There is still a chance that SB 535 could pass, pushing the deadline for hybrids to July 1, 2011. Source: hybridcars.com.
- Rebates of up to \$5,000 per light-duty vehicle will be available for individuals and business owners who purchase or lease new eligible zero-emission or plug-in vehicles until the funding runs out. Plug-in hybrids qualify for rebates up to \$3,000 and electric motorcycles and neighborhood electric vehicles up to \$1,500. Certain zero-emission commercial vehicles are eligible for rebates up to \$20,000. Vehicles must be purchased or leased after official launch of the program on March 15, 2010.
- Sacramento offers free parking to individuals or small businesses certified by the city’s Office of Small Business Development that own or lease EVs with an EV parking pass in designated downtown parking garages and surface lots. Free EV charging is also provided in several parking garages.
- Many utilities offer discounted rates for residential vehicle charging during off-peak hours.
- Hybrid Car owners who have purchased their hybrids from **San Jose** dealers are exempt from local parking fees.
- On February 10, 2009, the **Los Angeles** City Council voted to end the free metered parking program for alternative fuel vehicles begun in 2002. The City of Los Angeles

Department of Transportation (LADOT) will begin citing alternative fuel vehicles parked at expired parking meters starting March 1, 2009.

- Alternative fuel, hybrid, or electric vehicle with decals are allowed by **Santa Monica** Municipal Code (3.16.120) to park in any metered parking space in the city without charge for the maximum amount of time allowed by that meter. Clean Air Vehicle decals are issued by the state.

## NEW YORK INCENTIVES

*Source: hybridcars.com*

- New York's Alternative Fuel (Clean Fuel) Vehicle Tax Incentive Program, which offered tax credits and a tax exemption for purchasing new hybrid electric vehicles (HEVs), has expired. In January 2006, Governor Pataki proposed new incentives. For more information, please contact the New York State Energy Research & Development Authority (NYSERDA) at 866- NYSERDA, via email at [info@nyserda.org](mailto:info@nyserda.org), or visit the website at [www.nyserda.org](http://www.nyserda.org).
- Clean Pass is a program allowing eligible low-emission, energy-efficient vehicles to use the 40-mile Long Island Expressway High Occupancy Vehicle (LIE/HOV) lanes. Clean Pass is a multi-agency pilot program partnering three New York State agencies, the State Department of Transportation (NYSDOT), the State Department of Motor Vehicles (DMV), and State Department of Environmental Conservation (DEC). The number to inquire about a Clean Pass sticker is (518) 486-9786, Option 7.
- Hybrid owners in Westchester County are allowed to park for free at two county-owned commuter lots. The cost of a monthly permit is usually \$75.00. For more information, contact County Legislator Martin Rogowski at [mlr1@westchestergov.com](mailto:mlr1@westchestergov.com).

## ILLINOIS INCENTIVES

*Source: alternative fuels and advanced vehicles data center.*

### High-Occupancy Toll Lane Access

Phase Two of the Illinois Tollway Congestion-Relief Program (PDF 840 KB) includes a Dedicated Green Lanes Plan that will provide access to qualified hybrid electric vehicles at premium prices. The conversion is scheduled to begin in 2010.

### Neighborhood Electric Vehicle (NEV) Access to Roadways

Neighborhood vehicles may only be operated on streets if authorized by the local government and posted speed limits are 35 miles per hour (mph) or less. Neighborhood vehicles are allowed to cross a road or street at an intersection where the road or street has a posted speed limit greater than 35 mph. Neighborhood vehicles are defined as self-propelled, electronically powered, four-wheeled motor vehicles (or a self-propelled, gasoline-powered four-wheeled

motor vehicle with an engine displacement under 1200 cubic centimeters) that are capable of attaining in 1 mile a speed of more than 20 mph but not more than 25 mph, and which conform to federal regulations under Title 49 of the Code of Federal Regulations, Part 571.500. (Reference 625 Illinois Compiled Statutes 5/11-1426.1)

*Source: hybridcars.com*

- Under its Green Rewards program, the Treasurer's Office has committed \$2 million in rebates to make high-mileage hybrid vehicles, which run on gasoline and electricity, more affordable. Illinois drivers are eligible for a \$1,000 rebate with the purchase of a new hybrid or other fuel efficient vehicle. Participating banks and credit unions agree to accept a discounted deposit rate from the state for 1 year in exchange for providing the \$1,000 rebates to Illinois residents. For more information: <http://www.treasurer.il.gov/cultivateillinois/greenrewards.aspx>.
- The Illinois Alternate Fuels Rebate Program (Rebate Program) provides rebates for 80 percent of the incremental cost of purchasing an AFV or converting a vehicle to operate on an alternative fuel. The maximum amount of each rebate is \$4,000. Eligible vehicles include natural gas, propane, and electric. Gasoline-electric hybrid vehicles are **not** eligible.

## **PENNSYLVANIA INCENTIVES**

*Source: alternative fuels and advanced vehicles data center.*

### **Alternative Fuel Vehicle (AFV), Hybrid Electric Vehicle (HEV), and Fueling Infrastructure Funding**

The Alternative Fuels Incentive Grant (AFIG) Program is administered by the Pennsylvania Department of Environmental Protection and provides financial assistance and information on alternative fuels, AFVs, HEVs, plug-in hybrid electric vehicles, anti-idling technologies that use alternatives to diesel fuel for heavy-duty trucks, and advanced vehicle technology research, development, and demonstration. Projects that result in product commercialization and the expansion of Pennsylvania companies will be favored in the selection process (reference Title 73 Pennsylvania Statutes 1647.3).

### **Plug-In Hybrid Electric Vehicle (PHEV) Promotion**

The Commonwealth of Pennsylvania urges auto manufacturers to develop and produce PHEVs for consumer use (reference House Resolution 106, 2007).

### **Alternative Fuels Tax**

A tax is imposed on alternative fuels used to propel vehicles of any kind on public highways. The rate of tax is determined on a gasoline gallon equivalent basis. The tax rates are posted in the Pennsylvania Bulletin (reference Title 75 Pennsylvania Statutes, Section 9004).

*Source: hybridcars.com*

- Pennsylvania's Department of Environmental Protection will offer an opportunity to Commonwealth residents to apply for a rebate to assist with the incremental cost for the purchase of a new hybrid, bi-fuel, dual-fuel, or dedicated alternative fuel vehicle. The rebate amount is \$500. The rebate will be offered as long as funds are available. Rebates will be offered on a "first-come, first-served" basis. Rebate applications shall be submitted no later than 6 months after the purchase.
- A press release issued by the Commonwealth of Pennsylvania on March 9, 2006: The program has been so successful, the state is expect to run out of rebate money sometime in April. DEP Secretary Kathleen A. McGinty said the commonwealth already has awarded more than \$1.3 million in rebates from the \$1.5 million allotted for the program for the 2005–06 fiscal year. Another \$1 million will become available for the fiscal year beginning July 1. Because buyers have 6 months from the time of the purchase to apply for the rebates, people buying hybrid electric and alternative fuel vehicles after the current funding runs out still will be able to apply for rebates when the programs reopens.

## **OHIO INCENTIVES**

*Source: alternative fuels and advanced vehicles data center.*

- No incentives listed regarding electric vehicles or electric plug-in hybrid vehicles.

## **MICHIGAN INCENTIVES**

*Source: alternative fuels and advanced vehicles data center.*

### **Advanced Vehicle Battery Manufacturer Tax Credits**

Manufacturers of traction battery packs for use in vehicles may be eligible for a tax credit from the Michigan Economic Growth Authority for tax years beginning on or after January 1, 2010, and ending before January 1, 2015. The amount of the credit is based on kilowatt hours of battery capacity. Qualified batteries must have a traction battery capacity of at least 4 kilowatt hours, be equipped with an electrical plug for charging purposes, and be installed in a new, qualified plug-in electric drive motor vehicle that qualifies for the federal tax credit specified in 26 U.S. Code 30D.

Beginning on or after January 1, 2012, a manufacturer may claim a tax credit of up to 75 percent of the qualified expenses for vehicle engineering to support battery integration, prototyping, and launching, so long as the expenses are incurred between January 1, 2009, and January 1, 2014. The same credit is available to a manufacturer that increases its engineering activities for advanced automotive battery technologies.

Taxpayers may also claim a tax credit equal to 50 percent of the capital investment expenses for the construction of an integrative cell manufacturing facility that includes anode and cathode manufacturing and cell assembly, if the project creates at least 300 new jobs in the



state. Taxpayers that have received federal loan guarantees may claim a credit equal to 25 percent of the capital investment expenses for the construction of a facility that will produce large-scale batteries and manufacture integrated power management, smart control, and storage systems, if the project creates at least 500 new jobs in the state.

### **Hybrid Electric Vehicle Research and Development Tax Credit**

A taxpayer engaged in research and development of a qualified hybrid system that has the primary purpose of propelling a motor vehicle may claim a tax credit under the Michigan Business Tax through December 31, 2015. This tax credit is equal to 3.9 percent of all wages, salaries, fees, bonuses, commissions, or other payments made in the taxable year on behalf of or for the benefit of employees for services performed in a qualified facility. The maximum amount of credit allowed for any one taxpayer is \$2 million per tax year.

### **Hybrid Transit Vehicle Promotion**

In an effort to promote best practices for public transportation services in Michigan, the Michigan Department of Transportation is directed to coordinate with the Michigan Economic Development Corporation to promote the transition of transit bus fleets to hybrid vehicles with improved fuel economy.

*Source: hybridcars.com*

- The City of Ferndale allows free parking at city meters for drivers of hybrids and other vehicles that average 30 miles per gallon or more in city driving. Owners of eligible automobiles must register and pay an annual fee in order to get a permit for the exemption. For more information: City Assessor at (248) 546-2372.

## **GEORGIA INCENTIVES**

*Source: alternative fuels and advanced vehicles data center.*

### **Zero-Emission Vehicle (ZEV) Tax Credit**

An income tax credit is available for 20 percent of the cost to purchase or lease a new ZEV, or \$5,000, whichever is less. For the purpose of this credit, a ZEV is defined as a motor vehicle that has zero tailpipe and evaporative emissions, including a pure electric vehicle. Low-speed vehicles do not qualify for this credit. Any portion of the credit not used in the year the ZEV is purchased or leased may be carried over for up to 5 years (reference Georgia Code 48-7-40.16).

### **Electric Vehicle Supply Equipment (EVSE) Tax Credit**

An eligible business enterprise may claim an income tax credit for the purchase or lease of qualified EVSE, provided the EVSE is located in the state. The amount of the credit is 10 percent of the cost of the EVSE or \$2,500, whichever is less.

Source: *hybridcars.com*

- Income tax credits for up to 20 percent of the cost of an electric car—maximum of \$5,000—or 10 percent (with a max of \$2,500) for a car conversion to use an “alternative fuel” including electricity.
- An income tax credit is available to any eligible business enterprise for the purchase or lease of each EV charger that is located in the state. The amount of the credit is 10 percent of the cost of the charger or \$2,500, whichever is less (reference Georgia Code 48-7-40.16).
- Contact: James Udi, Environmental Specialist, Georgia Environmental Protection Division, [james\\_udi@dnr.state.ga.us](mailto:james_udi@dnr.state.ga.us).
- Hybrid electric vehicles (HEVs) shall be authorized to use high-occupancy vehicle lanes, regardless of the number of passengers if the U.S. Congress or U.S. Department of Transportation approve such authorization through legislative or regulatory action (reference Georgia Code Section 32-9-4). The term “alternative fuel vehicle” is expanded to include HEVs. An HEV is defined as a motor vehicle which draws propulsion energy from onboard sources of stored energy, which include an internal combustion or heat engine using combustible fuel and a rechargeable energy storage system. HEVs must also meet federal Clean Air Act and California emissions standards and must have a fuel economy that is 1.5 times the Model Year 2002 EPA composite class average for the same vehicle class.

## **NORTH CAROLINA INCENTIVES**

Source: *alternative fuels and advanced vehicles data center*.

### **Alternative Fuel Vehicle (AFV) and Hybrid Electric Vehicle (HEV) Grants**

The Clean Fuel Advanced Technology (CFAT) project focuses on reducing transportation-related emissions in North Carolina’s non-attainment and maintenance counties for National Ambient Air Quality Standards. Projects that are adjacent to areas may also be eligible if emissions will be reduced in the eligible counties. The project is funded by the North Carolina Department of Transportation, State Energy Office, and the Division of Air Quality, and covers three broad areas: education and outreach, project funding, and recognition of exemplary activities. Although funding is not currently available, future financial support may be available for AFVs, fueling infrastructure, idle reduction technologies, heavy-duty HEVs, heavy-duty buses, and diesel retrofits.

### **Alternative Fuel and Alternative Fuel Vehicle (AFV) Fund**

The North Carolina State Energy Office administers an energy credit banking program, which enables the state to generate funds from the sale of Energy Policy Act of 1992 (EPAct) credits. The monies generated by the sale of EPAct credits are deposited into the Alternative Fuel Revolving Fund (Fund), which enables state agencies to offset the incremental costs of purchasing alternative fuel, developing fueling infrastructure, and purchasing AFVs. Funds are distributed to state departments, institutions, and agencies in proportion to the number of EPAct

credits generated by each. For the purposes of this program, the definition of alternative fuel includes 100 percent biodiesel (B100), biodiesel blends of at least 20 percent (B20), ethanol/gasoline blends consisting of at least 85 percent ethanol (E85), compressed natural gas, propane, and electricity, and includes hybrid electric vehicles. The Fund also covers additional projects approved by the Energy Policy Council (reference Senate Bill 457, 2009, and North Carolina General Statutes 143-58.4, 143-58.5, 143-341(8)i, and 136-28.13).

### **Alternative Fuel Vehicle (AFV) and Hybrid Electric Vehicle (HEV) Loans**

State and local government credit unions offer green vehicle loans to purchase new AFVs, HEVs, and qualified fuel-efficient vehicles. The loans are offered at a 1 percent interest rate discount as compared to traditional new vehicle loan rates.



## **WORK REQUEST FIFTEEN: EXAMINATION OF PORT ARANSAS FERRY OPERATIONS FOR THE CORPUS CHRISTI DISTRICT**

At the request of the Corpus Christi District of TxDOT, TTI performed an analysis of alternative means to control pre-boarding management for Port Aransas Ferry operations. This analysis represents the first stage of several analysis phases intended, in total, to provide results and associated recommendations for the complete storage, management, and traffic control of vehicles approaching and using the ferry system on both the City of Port Aransas (on Mustang Island) and on the mainland approach from Harbor Island.

### **CURRENT OPERATIONS**

The Port Aransas Ferry provides route continuity along SH 361 over the Corpus Christi Channel between Aransas Pass and Port Aransas (Figure 54). The ferry operates 24 hours a day, 7 days a week, weather permitting. Up to six ferry boats can operate at one time, depending on traffic demand. Five ramps/docks each exist on both the Harbor and Mustang Island sides of the channel; a sixth dock on the Mustang Island side is a maintenance and fueling station.

Each of the six existing ferry boats is of the same design and has four loading lanes designed to carry five vehicles each, for a total capacity of 20 vehicles. Realistically, the average vehicle loading is 16 to 18 vehicles, accounting for larger pickup trucks, vehicles pulling trailers, recreational vehicles, trucks, etc. Truck weight is limited to 80,000 lb; when such a vehicle is loaded it occupies one of the center two lanes and passenger vehicles are loaded on the other side of the ferry to balance the load. Vehicles are loaded on a first-come, first-served basis under normal operating conditions; however, when emergency vehicles or law enforcement responding to calls are approaching the ferry from either side the next available ferry is held to provide expedited service.

The highest traffic volume demands for the ferry occur during holiday weekends and during the summer vacation months. Signs are posted along ferry approaches (Figure 55) to provide users with an indication of distance to the ferry landing; when wait time is excessive traffic is encouraged to approach and depart Port Aransas using SH 361 to the southwest, following a route connecting to Park Road 22 and SH 358 through Corpus Christi (see Figure 56). Wait times can exceed 2 hours and queues can exceed 2 miles in total length during peak demand hours during the year.



**Figure 54. Port Aransas Ferry/SH 361 at Corpus Christi Channel.**  
(Source: Google™ Earth; accessed 8/19/2010)



**Figure 55. SH 361 Ferry Wait Signing along Harbor Island Approach.**



**Figure 56. Port Aransas Route Alternatives from I-37.**

## UPCOMING CHANGES

Several planned improvements are under way and being investigated for improving the efficiency of the Port Aransas Ferry system. The first of these changes is the addition of two new and larger ferry boats in everyday operation. Rather than carrying a maximum load of 20 passenger vehicles, the new boats will be able to carry a maximum of 28 passenger vehicles. In addition, the new boats will have a “pass-through” design with three lanes storing eight vehicles each and a side pull-out lane capable of storing four additional vehicles. All lanes will be side-by-side on the new ferry, whereas the existing ferry fleet has a center tower supporting the wheelhouse that splits the loading lanes into two left and two right lanes. The first of the two new ferry boats is expected to be in operation in December 2010; the second new boat will follow roughly 1 year later.

Another change being investigated for the ferry system is the addition of a more informative and broadly reaching traveler information system for ferry wait times. Currently, online images of the ferry landings are available through TxDOT and posted on the City of Port Aransas website at (<http://www.cityofportaransas.org/ferrycam.cfm>). Wait times and other status information can be found on the same website (<http://www.cityofportaransas.org/txdot/status.pdf>). System enhancements being considered include using roadside Bluetooth technology to monitor travel times through the ferry system in real time, calculate wait times from the travel time data, and post wait times on mobile device websites and roadside dynamic message signs at strategic locations along I-37.

## PREVIOUS STUDIES

Several previous studies have been performed on aspects of Port Aransas Ferry operation. The first such study was performed in 2001 and was intended to identify options for increasing ferry capacity. Options analyzed in detail included adding ferry ramps/docks (four regular use ramps/docks were found on each landing at that time), expanding the size and/or number of ferry boats in operation, and even more capital-intensive options including bridges and tunnels (1, 2).

A 2004 study was performed regarding ferry system rider's willingness to pay for either tolled operation of the Port Aransas ferry system or for priority boarding passes to "move to the head of the line" for ferry service (3). One of the most significant findings from this study with respect to priority boarding was a large majority of motorists indicating a willingness to pay \$1 for a ferry trip. However, most motorists indicated that they did not wish to pay a significant sum for an annual pass, nor did they wish for ferry operations to be tolled.

The most recent operations study occurred in 2005 (4) and was prompted by the passage of a new law in the 79th Texas legislative session that permitted priority boarding (and associated fee charges) as per Section 370.193 of the Texas Transportation Code. This study estimated queue lengths in both the standard and a hypothetical added priority boarding lane added along the approach to each ferry landing. Several simulation tools were used to produce reasonable estimates of queue lengths and impacts; however, since priority boarding was never enacted for the ferry system due to inadequate priority boarding pass purchases, the results and findings from this study were never used and/or validated.

## METHODOLOGY

The current investigation will make use of the VISSIM (5) traffic simulation model developed during previous studies of ferry operation (1, 4). The types of information observed in the field and incorporated into the ferry modeling include:

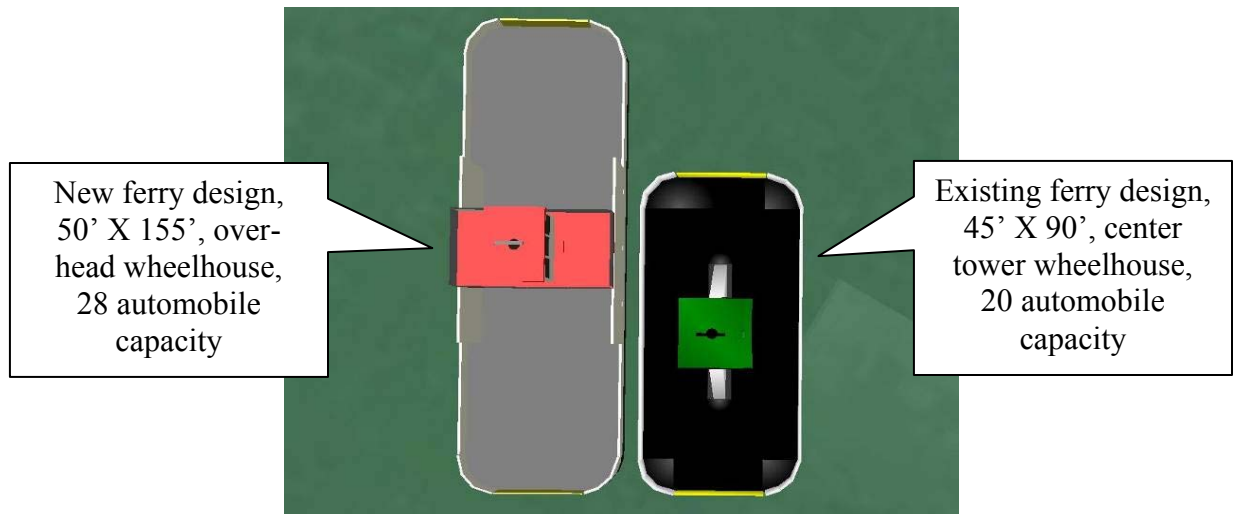
- ferry landing layouts,
- ferry operating/cycle times based on the number of ferries operating at any one time,
- distribution of loading times, ferry crossing times, and unloading times,
- distribution of number of vehicles using each ferry under different conditions,
- ferry operations practices, and
- traffic demand data (ferry captain's logs and roadway count data).

The above details, along with physical layout information for each ferry landing, were coded into the simulation model. During previous studies, only four ramps/docks existed at each ferry landing. An additional ramp and approach ramp loading/unloading path were coded onto the landing on each side of the channel to simulate current conditions. In addition, the new ferry boat was coded into the model so that realistic operations simulation could be performed and demonstrated in both 2-D and 3-D models (Figures 58 and 59). A special feature within VISSIM is the ability to custom-code traffic control using a built-in program known as VAP. In this case, VAP was used along with detectors and signals on the roadways and ferry crossings to completely replicate the control and operating environment of the Port Aransas ferry. Figure 57



contains a flowchart guide to the control logic governing traffic loading into the pre-boarding lanes for each ramp, the release of these vehicle onto a ferry, ferry transfer across the channel, and vehicle unloading.





**Figure 58. Old and New Ferry Boat Designs (as Modeled in VISSIM).**

Figure 59 contains a 3-D image of VISSIM, which includes the specially designed ferries that replicate the ferry boats used in current operation and the new ferry that will be brought online in December 2010. In versions of the VISSIM model used for previous studies (1, 4), the basic control logic merely counted the average number of vehicles allowed into the pre-boarding/staging area for each ferry loading ramp. The updated version of this logic accounts for the length of each vehicle to calculate the number of vehicles allowed into the pre-boarding storage lanes for each ramp; these changes were made to more realistically account for the effect trucks have on ferry loading/unloading and to properly load the new, larger boats.



**Figure 59. VISSIM Representation of Port Aransas Ferry Operations.**

Up-to-date ferry captain's logs of ferry operation during the Memorial Day Weekend, 2010, were provided by TxDOT Port Aransas ferry operations staff and used to update log data

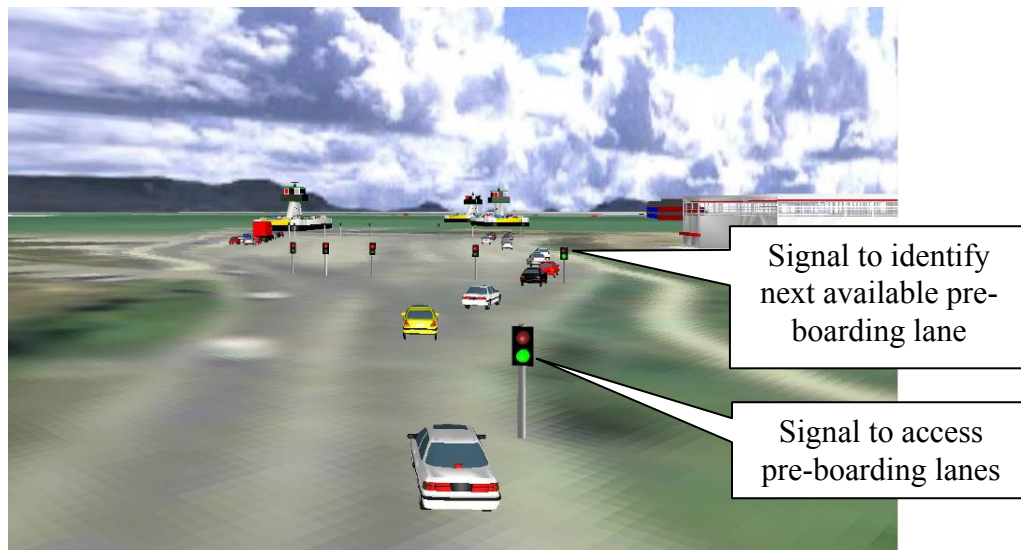
from the year 2000 and 2005 that were used in previous studies (1, 4). Current videos of ferry operations, also supplied by TxDOT staff, were used to verify model operation.

### OPTIONAL CONTROL STRATEGIES

Two control/traffic management options were developed in VISSIM. The first option is an emulation of current operations within the VISSIM model, where traffic loading management of vehicles into the staging lanes for each ramp is accomplished by traffic director/manager staff. The second option demonstrates the management of traffic approaching each landing and entering each staging lane/ramp using semi-automated traffic signals in lieu of human traffic directors. Figure 60 provides visualizations of each scenario.



a) Existing, Manual Control and Traffic Direction for Pre-Boarding



b) Potential, Signal Control and Traffic Direction for Pre-Boarding

**Figure 60. Port Aransas Ferry Operation Scenarios in VISSIM (Harbor Island Approach).**

## RESULTS

Two operational alternatives analyzed using the VISSIM ferry system model were the basic capacity of the ferry system using the existing fleet of 20-vehicle ferries and a modified fleet where one of the existing ferries is replaced by the new, 28-vehicle ferry boat. Traffic loading conditions for the analysis were based on the ferry captain's logs and estimated queue lengths on the ferry approaches for the Memorial Day Weekend, 2010. The specific time of day modeled represented the average peak demand condition from 11 a.m. to 3 p.m. on May 29 and May 30.

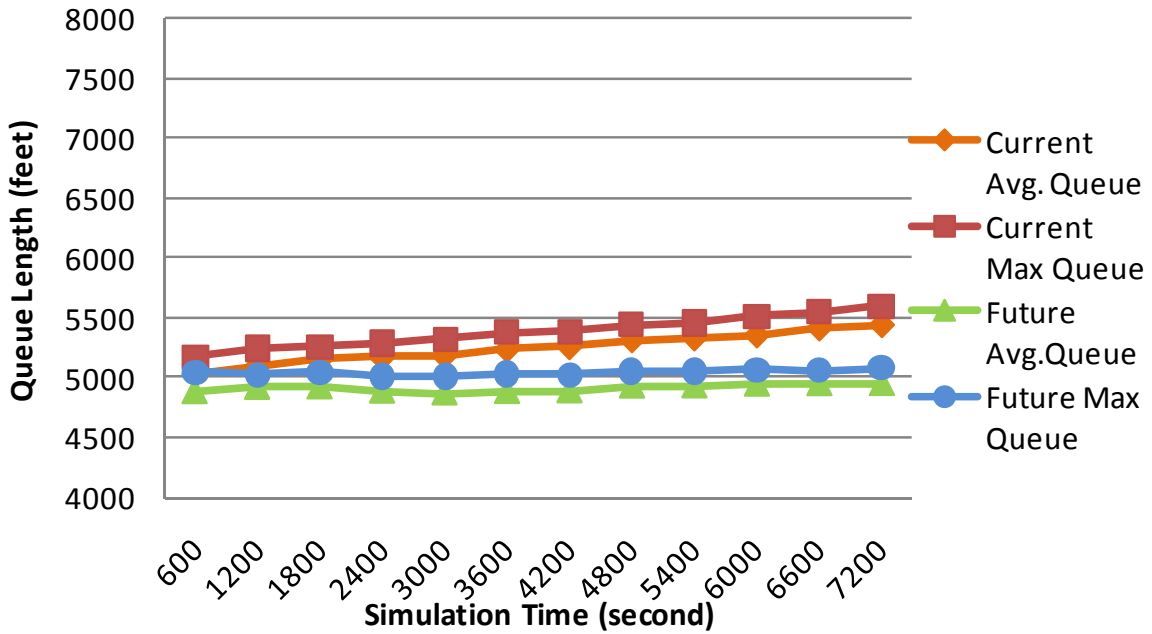
In order to more accurately reflect the impact of the new ferry boat on operations, the model factored in an increased loading time for the new ferries, since the new ferry is expected to carry between 22 and 24 vehicles as its average load compared with a 16 to 18 vehicle average load for the existing ferry boats. The loading time factored into the model was modified for the new ferry in proportion to the increase in vehicle load (i.e., 35 percent).

Table 26 contains the performance measures extracted from the VISSIM model for operations with the existing/older and modified ferry fleets. The results show a 3.5 percent increase in ferry traffic volume which, when translated into total wait time, results in a 9.3 percent reduction in total vehicle delay. Average delay for a vehicle making a trip using the ferry system dropped by about 3 minutes, or 8 percent.

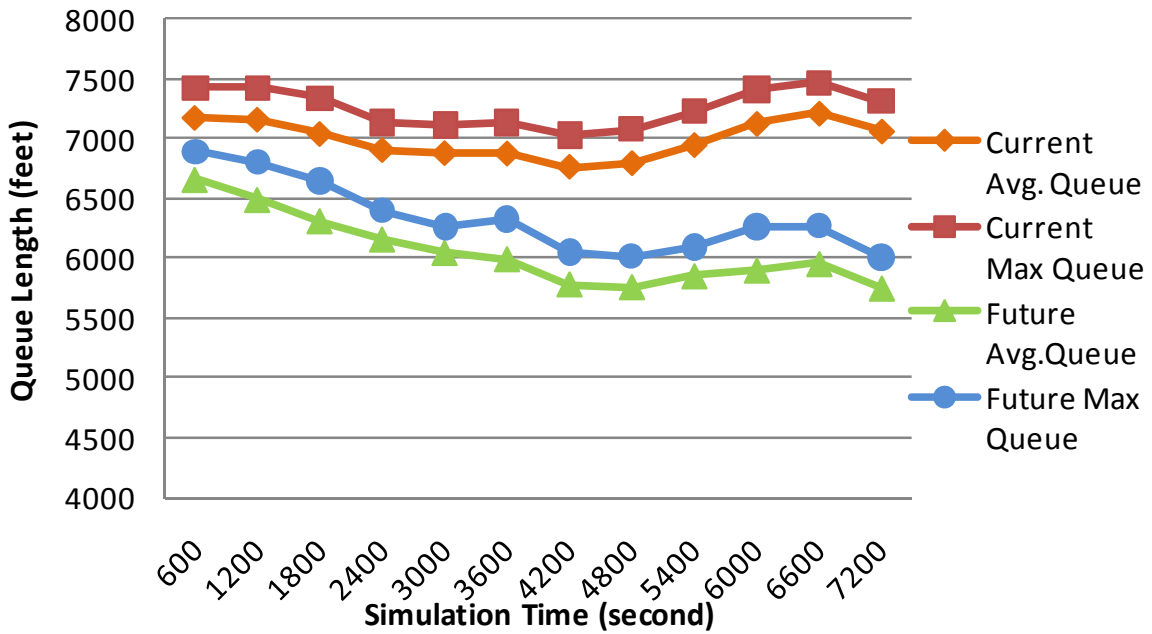
**Table 26. Port Aransas Ferry Operations with Existing and Modified Fleets (2-Hour Analysis).**

| <b>Performance Measure</b>   | <b>Current Fleet<br/>(Six 20-vehicle ferries)</b> | <b>Modified Fleet<br/>(Five 20-vehicle ferries and<br/>One 28-vehicle ferry)</b> |
|--|---|--|
| Vehicles Reaching Port Aransas<br>(number of vehicles in 2 hours)  | 722   | 746  |
| Vehicles Reaching Harbor Island<br>(number of vehicles in 2 hours) | 643   | 667  |
| Average Delay per Vehicle<br>(seconds/hours)                       | 2227 / 0.62                                       | 2049 / 0.57  |
| Total Vehicle Delay<br>(hours)                                     | 1305  | 1184   |

Figure 61 provides an indication of the queuing behavior over time on each ferry approach for the average peak hours during Memorial Day weekend simulated conditions. The lower volume approach during this time period, northbound at Port Aransas, shows a building queue during the high-volume loading conditions of the peak 2 hours. This queue reaches a length of about 1 mile for the existing fleet of smaller ferries and continues to slowly increase with increasing demand. For the modified/future fleet with the larger ferry, the queue is stable at a length of just under 1 mile. On the higher-volume Harbor Island southbound approach to the ferry, queue lengths are again higher for the existing ferry fleet, with a queue length of around 1.4 miles. With the modified fleet, however, the queue length actually decreases from roughly 1.25 miles to 1.1 miles despite having the same volume/demand during the peak 2-hour period.



a) Port Aransas Ferry Approach



b) Harbor Island Ferry Approach

Figure 61. Peak Hour Queue Length Comparisons – Existing and Modified Ferry Fleet.

## REFERENCES

1. Barricklow, P., S. Venglar and R. Henk. *Operational Analysis of Ferry Planning Scenarios*. By the Texas Transportation Institute for the Texas Department of Transportation, Corpus Christi District, August 2001 (revised May 2005).
2. *Port Aransas SH 361/Ship Channel Intersection Analysis*. By the Port Aransas Ferry Operations Working Group for the Texas Department of Transportation, Corpus Christi District, October 2002.
3. Jorgensen, D., P. Rhoades and W. Sherman. *Stated Preferences and Willingness-to-Pay: A Survey of Riders on the Port Aransas Ferry System Port Aransas, Texas*. By the Social Sciences Research Center, College of Arts and Humanities, Texas A&M University – Corpus Christi for the Texas Department of Transportation, Corpus Christi District, February 26, 2004.
4. Venglar, S. and C. Ghigiu. *Impacts of Priority Boarding on Queuing at the Port Aransas Ferry*. By the Texas Transportation Institute for the Texas Department of Transportation, Corpus Christi District, August 2005.
5. Verkehr in Städten - SIMulationsmodell (VISSIM), version 5.20. PTV Planung Transport Verkehr AG, Karlsruhe, Germany, distributed in the US by PTV America, Portland, Oregon.





**WORK REQUEST SIXTEEN:  
SUPPORT FOR PREPARATION OF PAPER AND ABSTRACT ON  
“REDUCING GREEN HOUSE GAS EMISSIONS IN ASPHALT PAVING  
OPERATIONS”**

**ABSTRACT FROM GREEN STREETS AND HIGHWAY CONFERENCE, NOVEMBER  
14–17, 2010, DENVER COLORADO**

TxDOT has undertaken major research and development efforts to implement technologies that reduce the consumption of energy, conserve natural resources, and reduce greenhouse gas emissions as well as lower production and life cycle costs. These specific technologies are associated with the production and placement of asphalt paving materials and include the use of reclaimed asphalt pavement (RAP), reclaimed asphalt shingles (RAS), and warm mix asphalt (WMA). Greenhouse gas emissions reductions associated with the use of these technologies are presented in this report.

Emission reduction information for this report is defined in terms of carbon dioxide equivalents (CO<sub>2</sub>eq). The potential reductions for each technology are defined as:

- an 8.5 percent reduction when the utilizing 20 percent RAP in hot mix asphalt;
- a 7.2 percent reduction with the use of 5 percent RAS in hot mix asphalt; and
- a 10.1 percent reduction when placing WMA as compared to traditional hot mix asphalt.

Combinations of technologies yield even greater reductions. For example, the use of 15 percent RAP with 5 percent RAS in a warm mix asphalt operation can provide an emission savings slightly less than 25 percent, as compared to conventional hot mix asphalt.

Based on historical TxDOT asphalt mixture tonnage information, the 2010 construction season is expected to produce a reduction of approximately 20,500 tons of CO<sub>2</sub>eq, or 3.8 percent, using these new technologies, as compared to using conventional hot mix asphalt. These savings are equivalent to the CO<sub>2</sub>eq produced from 2,100,000 gallons of fuel consumed or providing electricity to over 2,400 homes for one year. The potential for further emissions reductions is dependent upon full implementation of these technologies and could produce an annual savings of up to 113,000 tons of CO<sub>2</sub>eq, or 21 percent, within the next decade, as compared to conventional hot mix asphalt.

The use of RAP, RAS, and WMA will substantially reduce CO<sub>2</sub>eq emissions caused by the production and placement of asphalt mixtures in highway construction projects. The increased use of these technologies is presently allowed in current TxDOT specifications, and implementation continues at a rapid rate. TxDOT’s experience illustrates the benefits of an aggressive implementation of new technologies to address the environmental concerns facing the highway transportation industry.

## **REDUCING GREEN HOUSE GAS EMISSION IN ASPHALT PAVING OPERATIONS**

### **Introduction**

TxDOT continues to build, rehabilitate, maintain, and operate the backbone of the highway transportation system in the state of Texas. These assets are a very important contributor to the economic well being of the state of Texas and its citizens.

TxDOT recognizes that it must continue to build, rehabilitate, maintain, and operate the highway system with an ever-increasing awareness of its impacts on the environment. The Department has undertaken major research and development efforts to implement technologies that not only reduce our use of natural resources, including asphalt binders and aggregates, but also reduce the energy consumption associated with the performance of these operations. These implemented technologies can reduce carbon dioxide (CO<sub>2</sub>) emissions and lower the production costs of these operations. Materials conservation, energy reduction, CO<sub>2</sub> reduction, and cost savings are all possible with these technologies—all while providing transportation facilities of equal or improved life cycles.

This briefing document provides information on CO<sub>2</sub> emissions associated with the use of asphalt-bound paving materials (asphalt concrete or hot mix asphalt). CO<sub>2</sub> is one of the gases that trap heat in the atmosphere—typically referred to as “greenhouse gases.” Some of the new technologies that are being implemented statewide by TxDOT to reduce energy consumption and the amount of CO<sub>2</sub> emitted by the Department’s highway construction activities include the use of reclaimed asphalt pavement (RAP), warm mix asphalt (WMA), and reclaimed asphalt shingles (RAS). Briefing documents defining materials conservation, energy reduction, and cost savings resulting from Department research, development, and implementation efforts will be provided at a later date.

### **Background**

As indicated above, CO<sub>2</sub> emission reductions are possible with the use of the three technologies listed above. These technologies are briefly discussed below, followed by additional background information that defines the basis for the calculations associated with CO<sub>2</sub> reductions.

### **Reclaimed Asphalt Pavement**

TxDOT is using increased quantities of RAP in hot mix asphalt and warm mix asphalt in Texas. Rather than disposing of RAP in landfills and utilizing RAP on unsurfaced roadways and in base course materials, TxDOT specifications allow RAP use as a partial replacement for new or virgin asphalt binder and aggregate in new hot mix and warm mix asphalt. In addition, technology improvements and new specifications changes now allow higher quantities of RAP in our mixtures. TxDOT contractors, at their own option, are using increased quantities of RAP due to economic incentives based on decreasing materials costs, resource conservation, and energy reductions.

## Warm Mix Asphalt

New specification changes also allow contractors to use warm mix asphalt technology, at their option. This relatively new technology reduces the temperature at which hot mix asphalt is produced and placed by 30–75°F. It has been quickly adopted by contractors throughout the state. These reduced production temperatures not only reduce CO<sub>2</sub> emissions but also reduce energy consumption associated with mixture production and provide an improved environment for workers—both at the mix plant and at the paver. Currently nine different warm mix asphalt technologies are approved for use by TxDOT.

## Reclaimed Asphalt Shingles

Presently, most shingle waste material is discarded in landfills. Reclaimed asphalt shingles are obtained from shingle manufacturing plants as plant waste or re-roofing operations commonly known as “tear-offs.” Shingles contain relatively large quantities of asphalt binders that can be recycled and used in hot mix asphalt and warm mix asphalt as a replacement for virgin asphalt binder. Recent TxDOT specification changes also allow the use of reclaimed asphalt shingles in hot mix and warm mix asphalt paving materials.

## Source of Emission Data

In this briefing document, three primary references form the basis for CO<sub>2</sub> emission data from the production and placement of various paving materials (1, 2, 3). Colas, an international construction materials company, has published the most complete summary available on CO<sub>2</sub> emissions from paving operations (1). The Canadian government developed a document defining methodologies to reduce energy associated with highway construction and maintenance operations (2). The third reference was developed by Granite Construction, a United States based transportation construction company (3). Granite’s report was recently presented at the Transportation Research Board Annual Meeting. The calculations contained in this briefing document are based on representative values for CO<sub>2</sub> generation from these three sources.

Information on quantities of materials produced and utilized for TxDOT projects was obtained from the Department’s SiteManager project database (4) and from the Construction Division’s Flexible Pavements Branch (5).

## Basis of Calculations

Carbon dioxide equivalent (CO<sub>2</sub>eq) is the most commonly used parameter to indicate the warming potential of various greenhouse gases as compared to CO<sub>2</sub>. A U.S. Environmental Protection Agency mathematical model was used to calculate CO<sub>2</sub>eq (6). The gases included in this model are CO<sub>2</sub>, methane, nitrous oxide, hydrofluorocarbons, perfluorocarbons, and sulfur hexafluoride.

We used references 1–3 to define the gases associated with various construction, rehabilitation, and maintenance operations. The data in these references are based on the “complete” production operations, including extraction and production of raw materials and production of the paving mixtures as shown below:

- extraction and production of asphalt binders and additives;

- extraction and production of aggregates;
- haul of asphalt binder, additives, and aggregates from production source to asphalt mixing plant;
- production of asphalt bound mixtures;
- transportation of mixture to the placement site on the highway; and
- placement and compaction of the mixture.

## Emission Reductions

As stated previously, this briefing document presents information defining the potential for CO<sub>2</sub> emission reductions associated with the use of RAP, WMA, and RAS technologies. These technologies have been a focus of research, development, and implementation efforts by TxDOT over the last few years. Information is presented in terms of technology-based reductions and annual TxDOT reductions.

### *Technology-Based Reductions*

Tables 27–29 summarize the CO<sub>2</sub>eq reduction possible with the use of the use of the various materials and technologies as compared to standard hot mix asphalt. Table 27 shows CO<sub>2</sub>eq emission data (pounds of CO<sub>2</sub>eq per ton of mixture) for standard hot mix asphalt and hot mix asphalt containing RAP and RAS. Note the table shows a percent reduction in CO<sub>2</sub>eq based on hot mix asphalt as the base material. A reduction in CO<sub>2</sub>eq of 8.5 percent is possible with the use of 20 percent RAP; a reduction of 7.2 percent is possible with the use of 5 percent RAS.

**Table 27. Recycled Materials Strategies.**

| Paving Strategy | Lb. of CO <sub>2</sub> eq/Ton of Mix | % Reduction from HMA |
|-----------------|--------------------------------------|----------------------|
| HMA             | 108.6                                | --                   |
| HMA 10% RAP     | 104.2                                | 4.1                  |
| HMA 20% RAP     | 99.4                                 | 8.5                  |
| HMA 40% RAP     | 90.4                                 | 16.8                 |
| HMA 3% RAS      | 102.8                                | 5.3                  |
| HMA 5% RAS      | 100.8                                | 7.2                  |

Table 28 shows representative values for CO<sub>2</sub>eq emission data for WMA technologies and percent reductions from standard hot mix asphalt. TxDOT currently approves the use of nine different WMA technologies, categorized as either chemical additives or plant modifications for water injection (foaming). The chemical additives as a group show slightly lower CO<sub>2</sub>eq reductions as compared to the foaming techniques due to the manufacture and distribution of the chemical additives. It should be noted, however, that larger reductions in temperatures can be achieved with the use of chemical additives as compared to the foaming systems. Production facility optimization is a critical factor for energy and CO<sub>2</sub> emission reductions.

**Table 28. Warm Mix Asphalt Strategies.**

| <b>Paving Strategy</b>      | <b>Lb. of CO<sub>2</sub>eq / Ton of Mix</b> | <b>% Reduction from HMA</b> |
|-----------------------------|---|-----------------------------|
| HMA                         | 108.6                                       | --                          |
| WMA – Additive              | 98.6  | 9.2                         |
| WMA – Foam H <sub>2</sub> O | 97.6  | 10.1                        |

Table 29 indicates that larger reductions in emissions are possible when a combination of these technologies is utilized. For example, a combination of 20 percent RAP utilization with WMA technology can reduce CO<sub>2</sub>eq by nearly 20 percent as compared to conventional hot mix asphalt. An aggressive use of WMA technology with 15 percent RAP and 5 percent RAS can result in a savings of nearly 25 percent as compared to conventional hot mix asphalt.

**Table 29. Combined Strategies.**

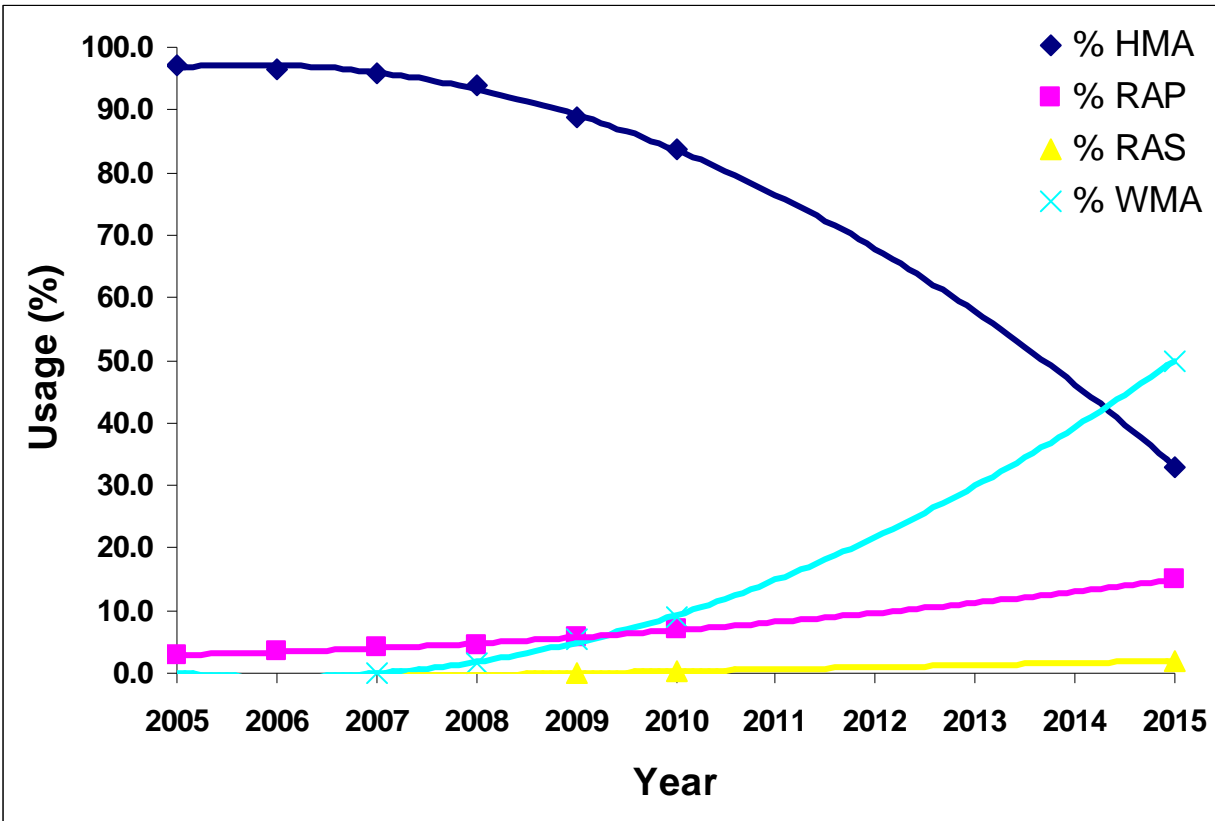
| <b>Paving Strategy</b> | <b>Lb. of CO<sub>2</sub>eq / Ton of Mix</b> | <b>% Reduction from HMA</b> |
|------------------------|---|-----------------------------|
| HMA                    | 108.6                                       | --                          |
| WMA 20% RAP            | 87.4  | 19.5                        |
| WMA 15% RAP 5% RAS     | 83.0  | 23.6                        |

*Annual TxDOT Reductions*

TxDOT research, development, and implementation programs have resulted in an increased utilization of RAP and WMA over the last several years. The use of RAS in TxDOT operations is in its infancy. Table 30 and Figure 62 contain historic data that indicate the utilization of RAP, WMA, and RAS since 2005 and estimates the quantities for 2010 and 2015. Note that Table 30 contains a column of information identified as All Mixes – HMA equivalent. This is the total tonnage of asphalt mixture produced for the year shown, but also the amount of hot mix asphalt that would be produced in that year if RAP, WMA, and RAS were not utilized. RAP and RAS replace the use of virgin or new asphalt binder and aggregate in hot mix asphalt, and WMA is produced at a lower temperature than hot mix asphalt. So the total of hot mix asphalt, RAP, WMA, and RAS will be the All Mixes – HMA equivalent column shown on Table 30.

**Table 30. Historic and Future Estimated Quantities (Tons).**

| Year    | HMA        | WMA       | RAP       | RAS     | All Mixes<br>-<br>HMA<br>equivalent |
|---------|------------|-----------|-----------|---------|-------------------------------------|
| FY 2005 | 10,369,259 | --        | 309,158   | --      | 10,678,417                          |
| FY 2006 | 12,366,568 | --        | 440,958   | --      | 12,807,525                          |
| FY 2007 | 11,465,803 | 1,200     | 488,261   | --      | 11,955,263                          |
| FY 2008 | 10,044,956 | 166,660   | 466,755   | --      | 10,678,371                          |
| FY 2009 | 8,162,198  | 497,410   | 534,827   | --      | 9,194,435                           |
| 2010    | 8,370,000  | 900,000   | 700,000   | 30,000  | 10,000,000                          |
| 2015    | 3,300,000  | 5,000,000 | 1,500,000 | 200,000 | 10,000,000                          |



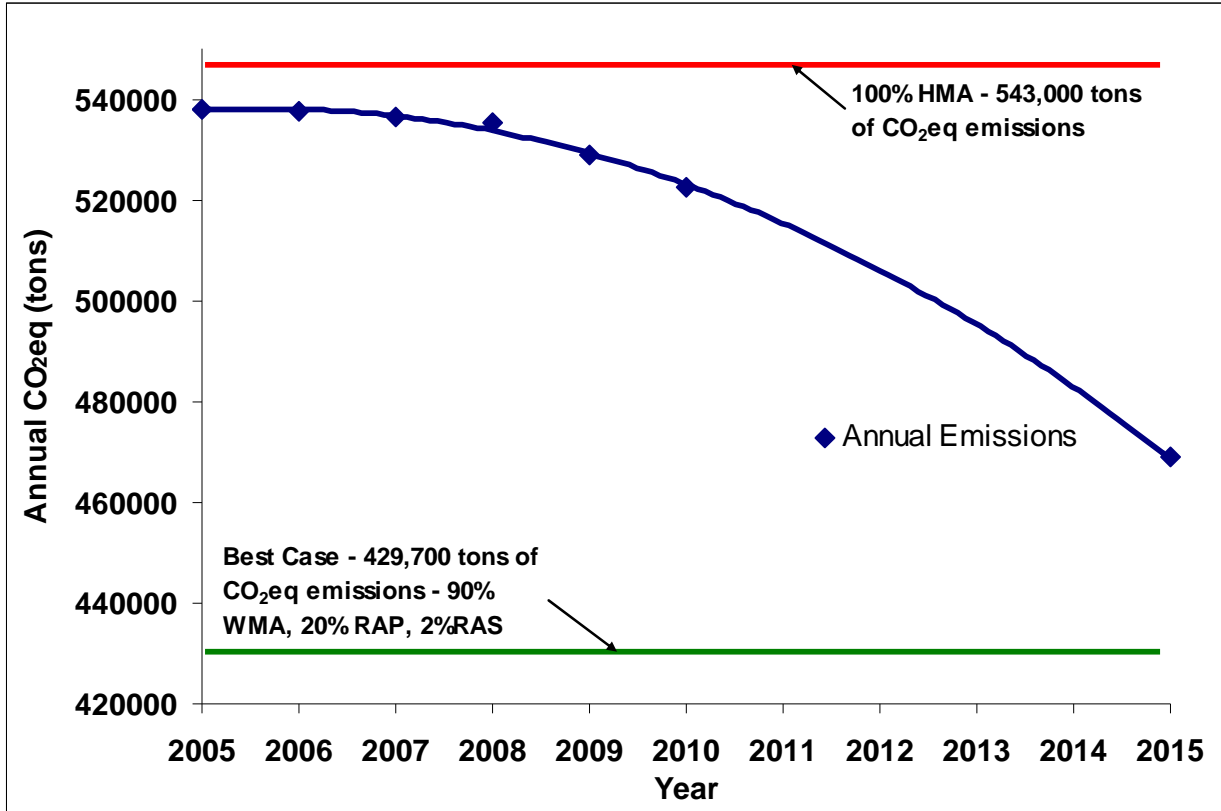
**Figure 62. Effect of Technologies on Hot Mix Asphalt Used, Percent.**

Table 31 and Figure 63 show the CO<sub>2</sub>eq reductions associated with the use of these technologies anticipated in the 2010 and 2015 construction seasons. Estimated tonnages are shown for each technology as well as the combination of all technologies. Overall reductions are based on comparisons with the use of 100 percent hot mix asphalt and a base annual mix production of 10,000,000 tons. For example, in 2010 an overall reduction in CO<sub>2</sub>eq resulting from these technologies is expected to be 20,647 tons, or 3.8 percent, as compared to the use of conventional hot mix asphalt.

**Table 31. Carbon Dioxide Reductions.**

| Year     | Materials     |               |               |               | Totals     |                    |                     |                  |
|----------|---------------|---------------|---------------|---------------|------------|--------------------|---------------------|------------------|
|          | HMA<br>(tons) | WMA<br>(tons) | RAP<br>(tons) | RAS<br>(tons) | Mix        | CO <sub>2</sub> eq | Reduction           | Reduction        |
|          |               |               |               |               | (tons)     | (tons)             | (tons) <sup>1</sup> | (%) <sup>1</sup> |
| Baseline | 10,000,000    | 0             | 0             | 0             | 10,000,000 | 543,000            | --                  | --               |
| 2010     | 8,370,000     | 900,000       | 700,000       | 30,000        | 10,000,000 | 522,353            | 20,647              | 3.8              |
| 2015     | 3,300,000     | 5,000,000     | 1,500,000     | 200,000       | 10,000,000 | 468,830            | 74,170              | 13.7             |

1. From Baseline—based on 10,000,000 tons of hot mix asphalt



**Figure 63. Effect of Technologies on Annual CO<sub>2</sub>eq Emissions.**

Figure 63 shows the annual CO<sub>2</sub>eq emissions and the overall reduction by the increased use of RAP, WMA, and RAS. This trend is expected to continue, as the estimated tonnages for 2010 and 2015 shown in Table 32 provide an even greater reduction in CO<sub>2</sub>eq emissions. Looking even further ahead, while availability and technology constraints may limit the use of RAP and RAS, the potential of WMA use could drastically increase over the next decade. A best case scenario shown in Figure 63 estimates 429,700 tons of emissions—a reduction of 113,300 tons, or 20.9 percent—and utilizes 90 percent WMA, 20 percent RAP, and 2 percent RAS.

We can convert the amount of CO<sub>2</sub>eq reduction associated with the use of these technologies in highway construction, rehabilitation, and maintenance into equivalent savings for commonly used consumer identifiable items such as gallons of gasoline, barrels of crude oil, electricity used in homes, and coal used to fire power plants. Table 32 shows these conversions.

For example, the savings expected in 2010 is equivalent to saving 2,106,934 gallons of fuel, which would be transported by 250 trucks. These savings also amount to 43,560 barrels of crude oil or 97.8 railcars of coal. These savings are also equivalent to the electricity supplied to 2433 homes for 1 year.

**Table 32. Carbon Dioxide Equivalencies.**

| Year | Reduced CO <sub>2</sub> eq (tons) <sup>1</sup> | Equivalent Reductions                      |                         |                         |  |                           | Tanker Trucks of Gas Consumed |
|------|--|--|-------------------------|-------------------------|--|---------------------------|-------------------------------|
|      |  | Vehicles Removed from Roadway for One Year | Gallons of Gas Consumed | Barrels of Oil Consumed | Homes Supplied with Electricity for One Year | Railcars of Coal Consumed |                               |
| 2010 | 20,647   | 3,581                                      | 2,106,934               | 43,560                  | 2,433  | 97.8                      | 250                           |
| 2015 | 74,170   | 12,865                                     | 7,568,716               | 156,479                 | 8,738  | 351                       | 898                           |

1. From Baseline—based on 10,000,000 tons of hot mix asphalt

### Future Directions

The use of reclaimed asphalt pavement, warm mix asphalt, and the recycling of asphalt shingles will substantially reduce CO<sub>2</sub>eq emissions caused by the production and placement of asphalt mixtures in highway construction projects. The use of these technologies is presently allowed in current TxDOT specifications, and their implementation continues at a rapid rate. Implementation of these technologies and others that are in the research and development stage will provide additional benefits to the citizens of the state. These technologies must be clearly understood, easily applied, and cost effective in order for TxDOT and the contracting community to work together to fully realize their benefits. Continued specification development and industry training are critical if these estimates are to be realized.

This briefing document presents information relative to CO<sub>2</sub>eq potential savings associated with these technologies. Additional research is needed to illustrate the material conservation, energy of construction, greenhouse gas and air pollutant emission reductions, and cost savings associated with these technologies and other possible technologies for TxDOT operations. Calculations should be developed not only for the initial use of these technologies but also for savings associated with the entire life cycle of the pavement.

Other areas in need of briefing documents include the savings associated with providing smooth roads to the driving public as well as determining these types of savings on a more global basis. The amount of CO<sub>2</sub>eq generation associated with the construction, rehabilitation, maintenance, and operation of highway systems is relatively small—usually less than 2 percent of the total CO<sub>2</sub>eq generated by automobiles, trucks, and buses that use the facilities.

TxDOT will continue to aggressively pursue technologies that are environmentally responsible. RAP, RAS, and WMA are three of the technologies that have been rapidly implemented.

### References

1. Chappat, M. and Julian Bilal, “The Environmental Road of the Future, Life Cycle Analysis,” Colas Group, 2003.



2. "Road Rehabilitation Energy Reduction Guide for Canadian Road Builders," Natural Resources Canada in collaboration with the Canadian Construction Association, 2005.
3. Robinette, Christopher and Jon A. Epps, "Energy, Emissions, Material Conservation and Prices Associated with Construction, Rehabilitation and Material Alternatives for Flexible Pavement," to be published by the Transportation Research Board (presented at the 2010 Annual Meeting of the Transportation Research Board, 2010).
4. Site Manager Reference.
5. Flexible Pavements CST Reference.
6. "Green House Gas Equivalencies Calculator," United States Environmental Protection Agency, (<http://www.epa.gov/cleanenergy/energy-resources/calculator.html>).



# **WORK REQUEST SEVENTEEN: ASSIST WITH APPLICATION FOR FEDERAL RAILROAD ADMINISTRATION HSIPR PROGRAM**

## **HOUSTON TO BEAUMONT/LOUISIANA STATE LINE CORRIDOR**

### **Introduction**

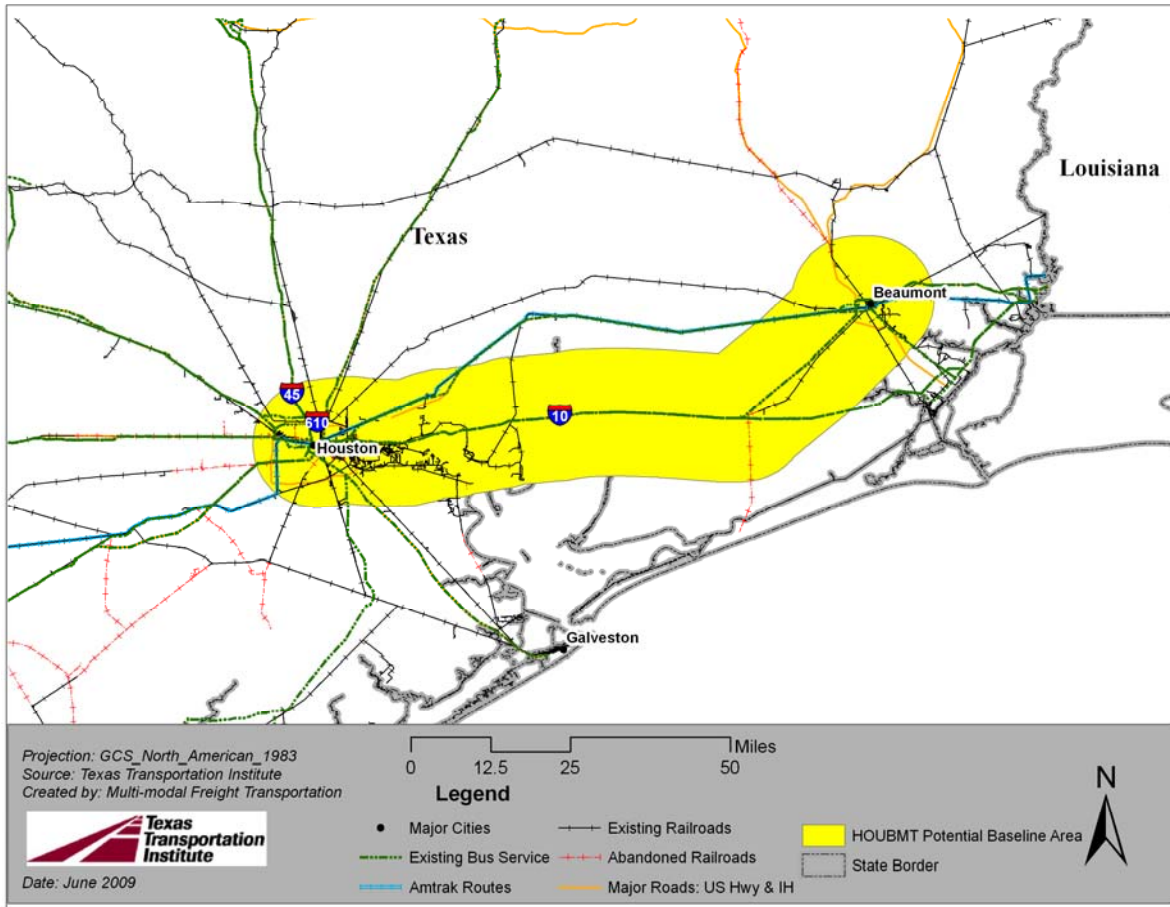
TTI recently completed TxDOT Research Project 0-5930 *Potential for Development of a Rail/Express Bus Intercity Transit System in Texas*. The study examined 18 intercity corridors within the state to determine current capacity for intercity travel by road, air, and rail. The study looked at population and employment projections for the state to 2040 and used the 2035 Federal Highway Administration (FHWA) Freight Analysis Framework (FAF) projected traffic levels to estimate segment-by-segment volume to capacity (V/C) ratios along existing roadway corridors. Project 0-5930 examined only longer-distance, intercity corridors and provided data on potential average rail travel times for corridors only up to higher speed rail (HrSR) speeds. The existing bus and rail transit systems connecting to each potential corridor were documented, as were a variety of demographic data along each route.

The Houston-Beaumont/Louisiana State Line Corridor was one of the potential routes examined since it is a part of the federally designated Gulf Coast High Speed Rail Corridor (Figure 64). Previous studies such as the November 2004 TxDOT-sponsored *Gulf Coast High-Speed Rail Corridor Evaluation: Houston to Echo, Texas High-Speed Rail Corridor Phased Implementation Plan* performed by Carter-Burgess and the 1998 Southern Rapid Rail Transit Commission-sponsored *Gulf Coast High Speed Rail Corridor, Phase II Report* performed by Morrison Knudsen Corporation have also looked at implementation of high speed rail (HSR) in this corridor.

The summary below contains information extracted from the final report for Project 0-5930, which is currently in-press at TxDOT, and some additional research added under a short-term research contract associated with development of the current High-Speed Intercity Passenger Rail (HSIPR) proposals. Information on HSR speeds has been added to tables for each corridor. Note that while some data elements include information for the entire region up to the Louisiana border (population, employment, etc.) because it is within the same Metropolitan Core-Based Statistical Area (CBSA) as Beaumont, some of the other corridor-based calculations were only for the Houston to Beaumont segment and do not include the approximately 30-mile segment extending from Beaumont eastward to the Louisiana border near Echo, Texas.

### **Houston to Beaumont Corridor Data Elements**

Project 0-5930 evaluated the corridor between Houston and Beaumont and identified existing transportation infrastructure along the route. The multi-criteria evaluation ranked this corridor 6<sup>th</sup> out of 18 evaluated corridors. The two heavily populated end points and highway travel demand enhanced the corridor's evaluation score. However, the short corridor length lessened its appeal for intercity passenger rail. Connections to the larger Gulf Coast Corridor were not taken into account in Project 0-5930 and would also improve the ranking of this corridor, if included, as they are for the current HSIPR application.



**Figure 64. Houston to Beaumont Corridor - Potential Baseline Area.**

The Houston-Sugar Land-Baytown and Beaumont-Port Arthur Core Based Statistical Areas (CBSAs) adjoin each other, with the Beaumont-Port Arthur CBSA stretching to the Texas-Louisiana border (Table 33).

**Table 33. Corridor Population Distribution and Estimated Travel Times at Various Average Speeds.**

| CBSA         | Population |           | Distance |            | Travel Time (hours:minutes) |        |         |         |         |
|--------------|------------|-----------|----------|------------|-----------------------------|--------|---------|---------|---------|
|              | 2000       | 2040      | Segment  | Cumulative | 60 mph                      | 80 mph | 110 mph | 150 mph | 200 mph |
| Houston      | 4,715,400  | 8,400,100 | 0        | 0          | 0:00                        | 0:00   | 0:00    | 0:00    | 0:00    |
| Beaumont     | 385,100    | 455,500   | 85       | 85         | 1:25                        | 1:04   | 0:46    | 0:34    | 0:25    |
| TX-LA border | 0          | 0         | 25       | 110        | 1:50                        | 1:23   | 1:00    | 0:44    | 0:33    |

*Market Potential Elements (Table 34):*

- Population, Economic Activity, and Special Generators:
  - Core Based Statistical Areas
    - Houston-Sugar Land-Baytown (Metropolitan)
    - Beaumont-Port Arthur (Metropolitan)
  - Population, Employment, and University Enrollment

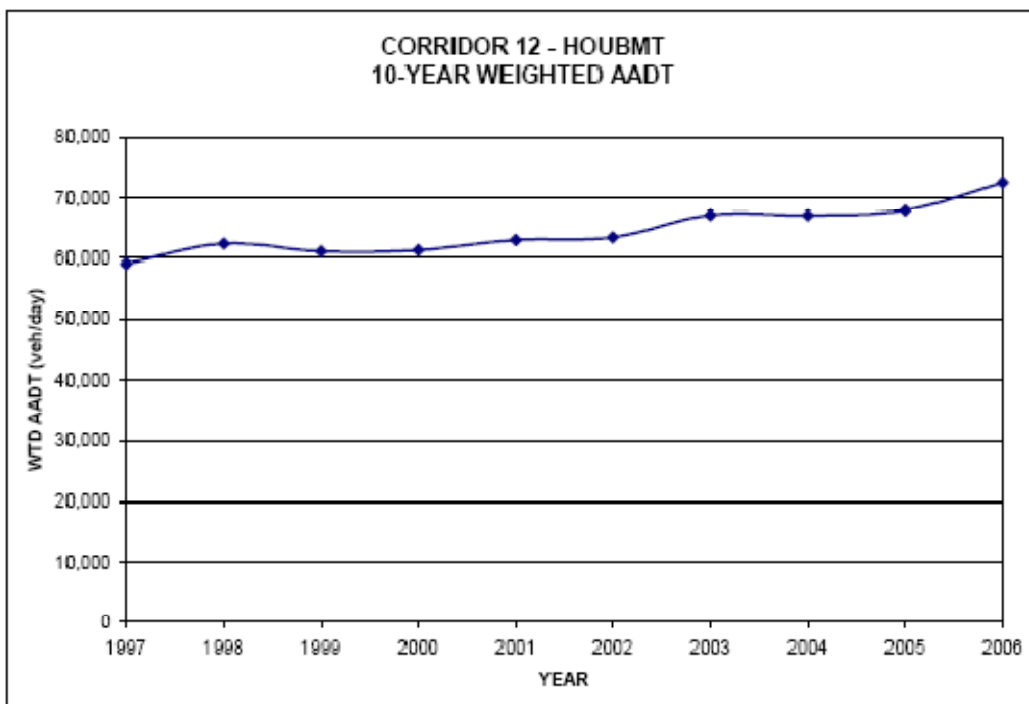
**Table 34. Market Potential Elements from Project 0-5930.**

| Data Element  | Houston to Beaumont |
|---|---------------------|
| Population (2000)   | 5,100,497           |
| Population per Mile (2000)*                               | 58,626              |
| Population (2040)   | 8,855,679           |
| Population per Miles (2040)*                              | 101,789             |
| Population - Over 65 (2000)                               | 418,258             |
| Population - Over 65 (2040)                               | 1,560,385           |
| No. of Employees (2005)                                   | 2,127,555           |
| No. of Employer Establishments (2005)                     | 122,516             |
| Total Public or Private University Enrollment (Fall 2006) | 105,779             |
| *Calculation using corridor length = 87 miles             |                     |

- Highway Travel Elements (Table 35, Figure 65):

**Table 35. Selected Highway Travel Elements from Project 0-5930.**

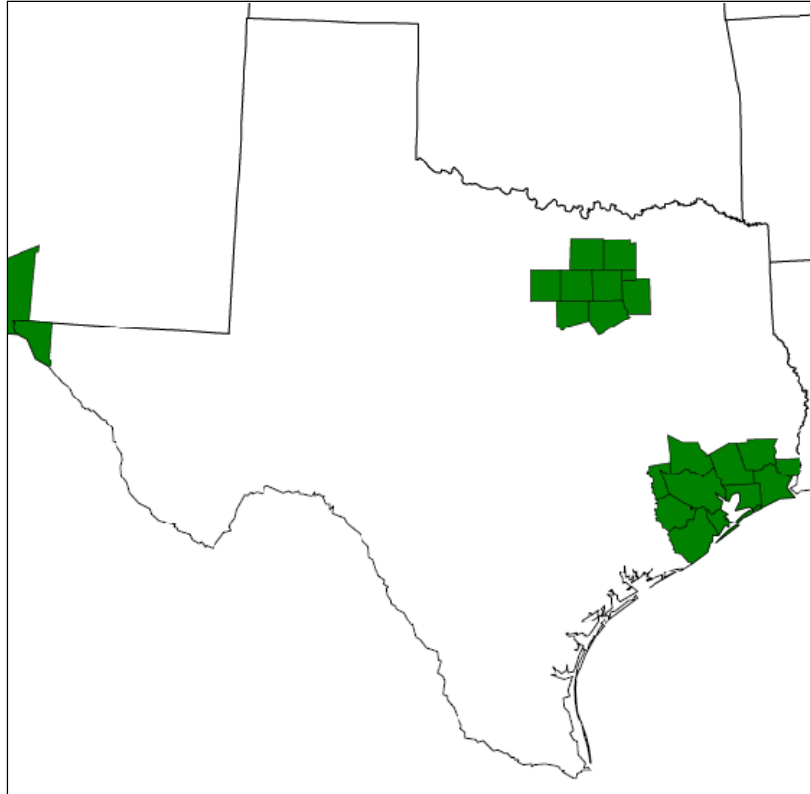
| Data Element   | Houston to Beaumont     |
|--|-------------------------|
| Average Corridor AADT, vehicles per day (2006)             | 72,525 vehicles per day |
| Projected AADT, vehicles per day (2035 FAF)                | 141,082                 |
| % Annual Growth in Average Corridor AADT (1997–2006)       | 2.27%                   |
| Weighted Average Volume-to-Capacity Ratio (2002)           | 0.69                    |
| Weighted Average Volume-to-Capacity Ratio (2035 projected) | 1.47                    |
| Weighted Average % Trucks (2002)                           | 17.79%                  |
| Weighted Average % Trucks (2035 projected)                 | 17.7%                   |



**Figure 65. Houston-Beaumont 10-Year Weighted AADT Trend (1996–2006).**

*Environmental Quality:*

- Air Quality Conformity:
  - As of January 6, 2010, the eight counties in the Houston area (Brazoria, Chambers, Fort Bend, Galveston, Harris, Liberty, Montgomery, and Waller) are designated as severe nonattainment for 8-Hr Ozone by the U.S. Environmental Protection Agency (EPA). In addition, the three counties in the Beaumont area (Hardin, Jefferson, and Orange) are designated as moderate nonattainment for 8-Hr ozone, as shown in Figure 66.



**Figure 66. Texas Counties Designated “Nonattainment” for Clean Air Act’s National Ambient Air Quality Standards (NAAQS).**

**Houston Area Non-Attainment:**

|               |            |   |
|---------------|------------|---|
| Brazoria Co   | 8-Hr Ozone | Houston-Galveston-Brazoria, TX - Severe |
| Chambers Co   | 8-Hr Ozone | Houston-Galveston-Brazoria, TX - Severe |
| Fort Bend Co  | 8-Hr Ozone | Houston-Galveston-Brazoria, TX - Severe |
| Galveston Co  | 8-Hr Ozone | Houston-Galveston-Brazoria, TX - Severe |
| Harris Co     | 8-Hr Ozone | Houston-Galveston-Brazoria, TX - Severe |
| Liberty Co    | 8-Hr Ozone | Houston-Galveston-Brazoria, TX - Severe |
| Montgomery Co | 8-Hr Ozone | Houston-Galveston-Brazoria, TX - Severe |
| Waller Co     | 8-Hr Ozone | Houston-Galveston-Brazoria, TX - Severe |

**Beaumont Area Non-Attainment:**

|              |            |                                     |
|--------------|------------|-------------------------------------|
| Hardin Co    | 8-Hr Ozone | Beaumont-Port Arthur, TX - Moderate |
| Jefferson Co | 8-Hr Ozone | Beaumont-Port Arthur, TX - Moderate |
| Orange Co    | 8-Hr Ozone | Beaumont-Port Arthur, TX - Moderate |

*Passenger Rail, Bus Transit, Air Services, and Freight Rail:*

- **Existing Passenger Rail Services:**
  - Current intercity rail service:





- Connect Transportation
- Fort Bend County Transit
- The District (Brazos Transit)
- Beaumont Municipal Transit
- Port Arthur Transit
- South East Texas Transit (SETT Rural Transit)
- Orange County Transportation (OCT, Holiday Transit Service)
- **Existing Air Service:**
  - Commercial airports:
    - Beaumont/Port Author (BPT)
    - Houston: Houston Hobby Airport (HOU), George Bush Intercontinental Airport (IAH)
  - Air travel demand for Corridor: Houston to Beaumont ([Table 36](#))

**Table 36. Air Travel Demand for Corridor Houston-Beaumont from 1996 to 2008.**

| Year  | Number of Flights | Number of Passengers | Number of Seats | Load Factor |
|---|-------------------|----------------------|-----------------|-------------|
| 1996  | 4,086             | 68,890               | 141,093         | 0.49        |
| 2008  | 3,378             | 55,688               | 116,419         | 0.48        |
| 1996–2008<br>(Average Annual<br>percent change) | -1.33%            | -1.47%               | -1.35%          | -0.16%      |

- In 2006, the average number of scheduled flights per day on the corridor between the two cities was nine flights/day.
- From 1996–2006, the total number of airline trips (in persons/mile) between Houston and Beaumont within this corridor decreased by 14.77 percent.
- City-pair market distance:
  - Beaumont BPT to/from Houston IAH is 79 miles, resulting in a smaller air market and higher potential for rail alternative to automobile travel.
- Air travel demand:
  - Houston Hobby and George Bush Intercontinental airports are among the seven busiest airports in Texas that will have greatly increased enplanements according to the Federal Aviation Administration’s (FAA’s) Terminal Area Forecast.
- **Existing Freight Rail Operations:**
  - Freight rail lines
    - Two parallel Union Pacific (UP)-owned lines between Houston and Beaumont – the Beaumont Subdivision and the Lafayette Subdivision

- The Amtrak Sunset Limited follows the Lafayette Subdivision, which closely parallels I-10
- *National Rail Freight Infrastructure Capacity and Investment Study* (2008) indicated for the Lafayette Subdivision:
  - Current: 25–50 trains per day
  - Future: 100–200 trains per day
- *National Transportation Atlas Database* (2007 version) indicated traffic for the Lafayette Subdivision:
  - 20–39.9 MGTM/Mi

## **HOUSTON TO AUSTIN CORRIDOR PLUS NEW ANALYSIS TO INCLUDE COLLEGE STATION/BRYAN IN CORRIDOR ANALYSIS**

### **Introduction**

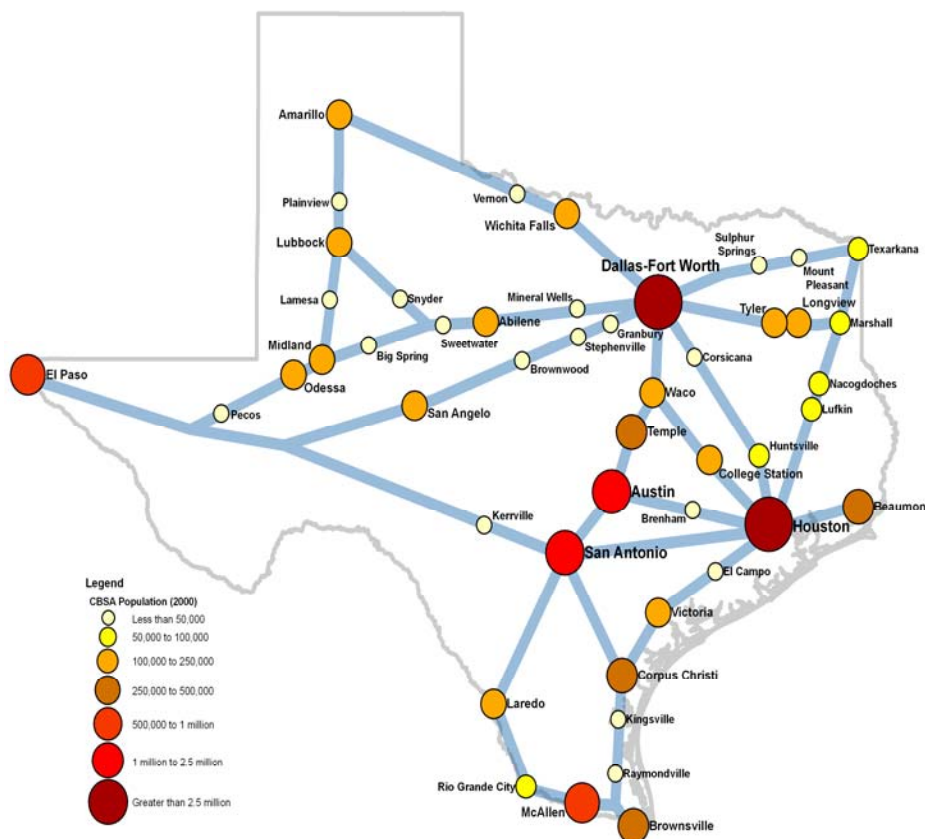
Texas has undergone a quiet transformation over the past several decades, passing New York in population to become the second most populous state in the United States behind only California. While much larger than the other two states, the population of Texas is concentrated largely within in the eastern half of the state—along and east of the I-35 corridor. Texas contains three of the United States’ top 10 urban areas by population—Dallas-Fort Worth, Houston, and San Antonio—all located within 200–300 miles of one another. The city of Austin, also over a million in population, is located on the I-35 corridor and serves as the state’s capital, attracting both business and government travelers. Texas sits at the crossroads, in the middle of the continent, astride trade and travel corridors connecting both north and south North American Free Trade Agreement (NAFTA) traffic and the east and west flow of goods from Asia to the eastern United States.

The State of Texas has long been a leader in provision of quality transportation infrastructure for its citizens. Along with its federal funding partners, the state has built the most expansive highway system of any state, with over 79,000 lane-miles. Texas has also benefitted from an excellent air transportation system that has steadily grown in use as urban airports in Dallas-Fort Worth and Houston have become national and international hubs. Airports in other Texas urban areas have grown to meet the intercity and regional travel demand that is not met by the highway system and as feeders to the hub airports for interstate travel. Over time, Texan’s urban and suburban work and travel patterns have shifted, becoming longer and more frequent. Interconnectivity between urban areas throughout the state has grown in importance as centers of both housing and commercial activity have spread along existing transportation routes.

The state’s burgeoning population and its rapid transition from a rural to an urban state have strained elements of the existing transportation system. Meeting the need for new intercity transportation capacity will require new financing and operational methods to provide the required infrastructure for continued economic growth and quality of life. High-performance intercity passenger rail systems must be considered as a part of the solution to meeting this challenge. A well-designed intercity rail system with coordinated transit connections in urban

areas served by it could improve performance of the existing highway and air transportation systems, allowing each mode—highway, air, and rail—to operate more effectively.

Figure 67 demonstrates the relative size of and distances between Texas’ population centers and the relative distance between these centers within the state of Texas along the corridors identified and studied by TTI during TxDOT Project 0-5930. The close proximity and growth in the major urban centers shows in the Texas Urban Triangle area including Dallas-Fort Worth, Houston, San Antonio, and Austin. The Houston to Austin Corridor connects two of Texas’ major urban centers, both of which are rapidly growing. The Austin and San Antonio urban areas are also connected north-south by the I-35 corridor, which is the subject of another HSIPR feasibility study application being filed in this round. Previous passenger rail studies along the proposed study corridor include regional intercity rail/commuter rail studies in both the Austin and Houston areas. The College-Station/Bryan CBSA is just north of the US 290 corridor and could be an intermediate route stop along the corridor.



**Figure 67. Relative Size and Distance of Texas Population Centers along Project 0-5930 Study Corridors.**

### Houston to Austin Corridor Overview

The Houston-Austin Corridor was considered in the 0-5930 study as one of the most direct routes to connect Houston, the United States’ fourth largest city, which is the current terminus of the federally designated Gulf Coast High Speed Rail Corridor, with the large

population centers of Austin and San Antonio in South Central Texas. Corridors connecting Houston to both San Antonio and Austin directly were ranked roughly equally (at numbers 5 and 6, respectively) in the Project 0-5930 analysis of statewide corridors. The number 1 and 2 ranked corridors are the subject of additional HSIPR study requests in this round of applications. The corridors that ranked 3 and 4 were long-distance corridors connecting the massive north Texas Dallas-Fort Worth (DFW) urban area to El Paso in west Texas via Abilene along I-20/I-10 and to Lubbock along I-20 and US 84. While these corridors ranked higher in total population that could be served, their length and relatively low population-per-mile combined with their potential rail service times of well over 3–4 hours, at even the highest HSR speeds, put them outside the current scope of study for HrSR and HSR routes and likely to remain more attractive for air travel.

The east-west Austin-Houston Corridor has several apparent potential advantages over the San Antonio-Houston Corridor related to existing public ownership of a rail corridor on its western third, an abandoned rail right-of-way that could be redeveloped in its middle third, and an existing private freight rail corridor on its eastern third into the city of Houston over which the private rail company owner has expressed willingness to cooperate with passenger rail feasibility studies. An existing U.S. highway, US 290, also runs the length of the corridor parallel to the railroad and could potentially share ROW with an HrSR or HSR system. This corridor feature is especially important in the abandoned rail segment of the corridor described more fully in the section on existing freight rail below.

Table 37 shows that the population of the Houston CBSA is expected to almost double to over 8.4 million people by 2040 according to numbers provided by the Texas State Demographer. The Austin CBSA population is expected to more than double to over 2.6 million people during the same period. Table 37 also shows the estimated travel times at various average travel speeds over the approximately 165-mile long corridor. A high-speed train traveling at an average speed of 110 mph could travel the corridor in 1.5 hours and at 200 mph could travel the length of the corridor in approximately 49 minutes. Selecting the appropriate speed and technology options would be a major focus of the proposed feasibility study. Table 38 shows alternative travel times and populations for a routing through College Station using existing highway distances for analysis.

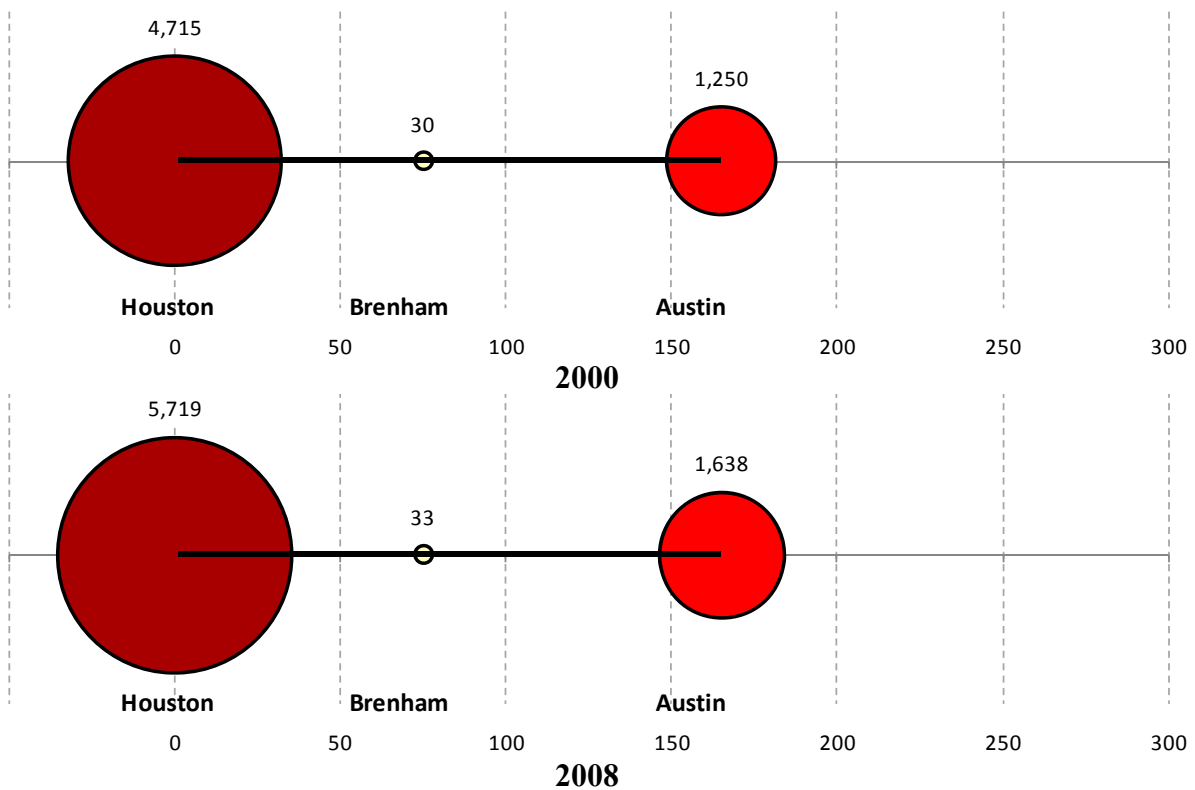
**Table 37. Houston to Austin CBSA Populations, Distances, and Estimated Travel Times.**

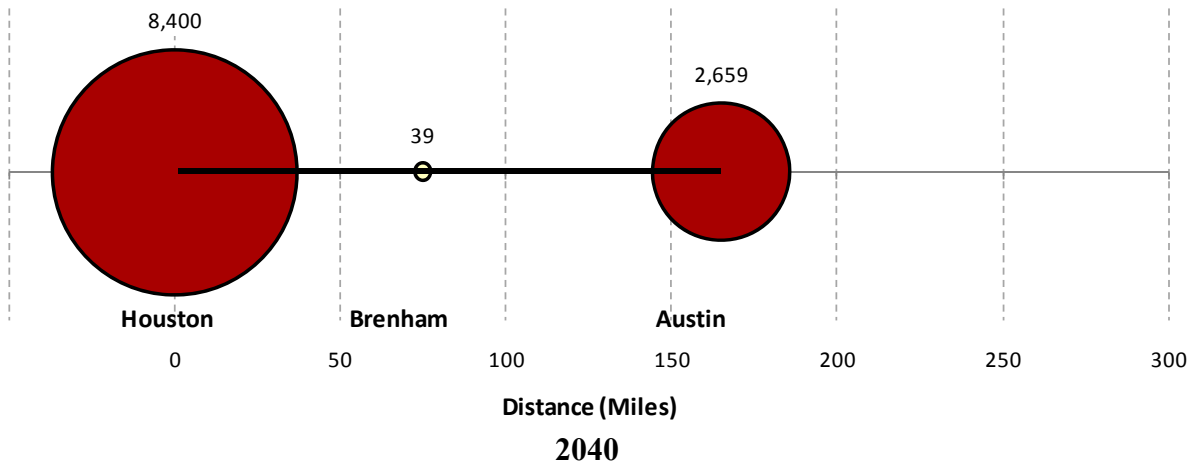
| CBSA    | Population |           |           | Distance |            | Travel Time (hours:minutes) |        |         |         |         |
|---------|------------|-----------|-----------|----------|------------|-----------------------------|--------|---------|---------|---------|
|         | 2000       | 2008      | 2040      | Segment  | Cumulative | 60 mph                      | 80 mph | 110 mph | 150 mph | 200 mph |
| Houston | 4,715,400  | 5,718,678 | 8,400,100 | 0        | 0          | 0:00                        | 0:00   | 0:00    | 0:00    | 0:00    |
| Brenham | 30,400     | 32,601    | 39,500    | 75       | 75         | 1:15                        | 0:56   | 0:40    | 0:30    | 0:22    |
| Austin  | 1,249,800  | 1,637,936 | 2,658,500 | 90       | 165        | 2:45                        | 2:03   | 1:30    | 1:06    | 0:49    |

**Table 38. Houston to Austin via College Station CBSA Populations, Distances, and Estimated Travel Times.**

| CBSA            | Population |           |           | Distance |            | Travel Time (hours:minutes) |        |         |         |         |
|-----------------|------------|-----------|-----------|----------|------------|-----------------------------|--------|---------|---------|---------|
|                 | 2000       | 2008      | 2040      | Segment  | Cumulative | 60 mph                      | 80 mph | 110 mph | 150 mph | 200 mph |
| Houston         | 4,715,400  | 5,718,700 | 8,400,100 | 0        | 0          | 0:00                        | 0:00   | 0:00    | 0:00    | 0:00    |
| College Station | 184,900    | 208,400   | 267,700   | 95       | 95         | 1:35                        | 1:11   | 0:51    | 0:38    | 0:28    |
| Austin          | 1,249,800  | 1,637,900 | 2,658,500 | 105      | 200        | 3:20                        | 2:30   | 1:49    | 1:20    | 1:00    |

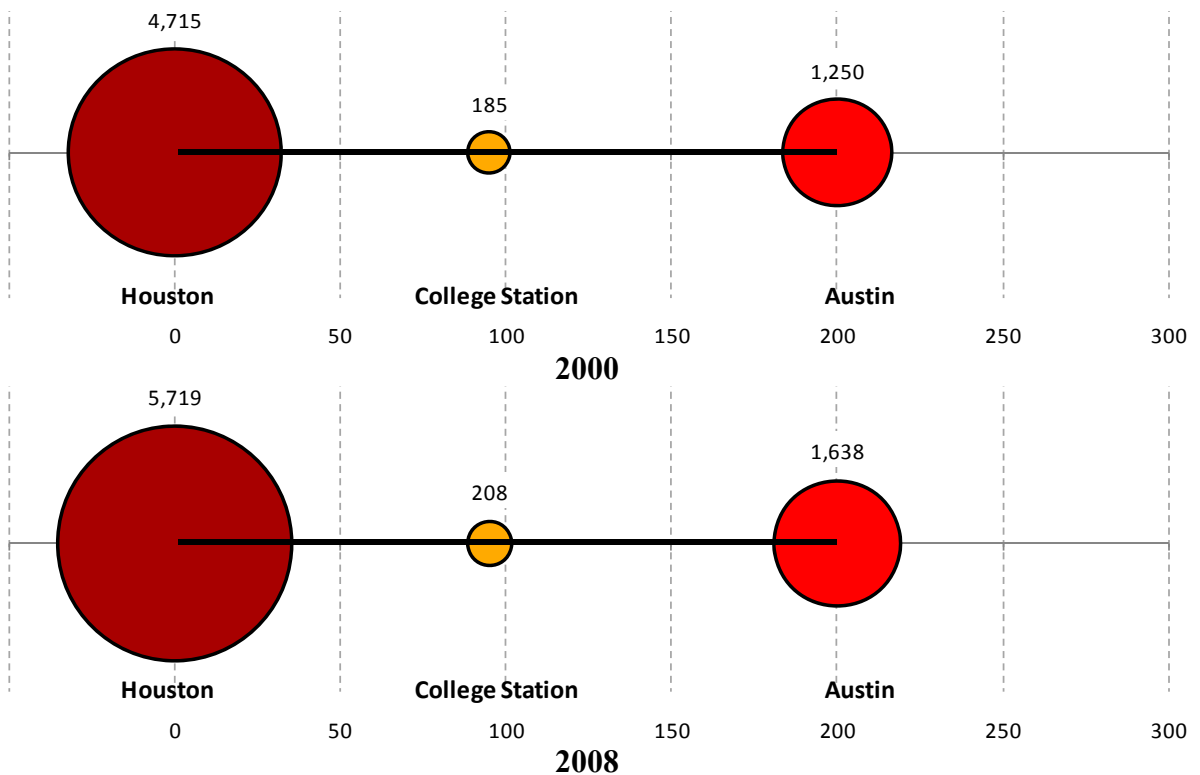
Figure 68 provides a view of the CBSA populations along the Houston to Austin Corridor, along with a demonstration of the distance between these urban centers. The corridor is approximately 165 miles in length with a total of three CBSAs, two metropolitan and one micropolitan. According to the 2000 Census, the Houston CBSA contained over 4.7 million people; the Austin CBSA contained over 1.2 million people; and the Brenham CBSA contained 30,000 people. Figure 68 also shows the census population estimates for 2008 and projected population for 2040 according to the Texas State Demographer.

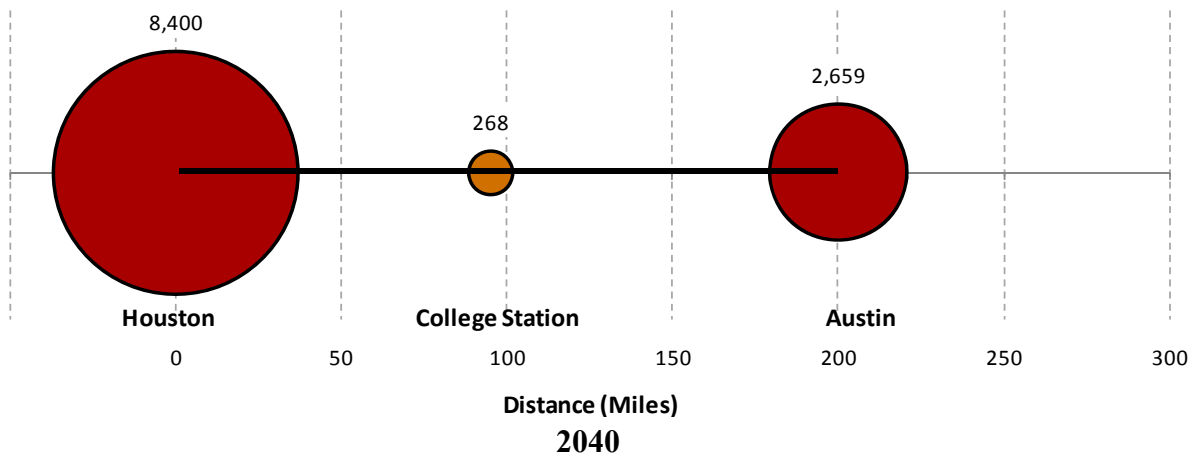




**Figure 68. Houston to Austin Corridor Population and Distance in 2000, 2008 Estimates, and Projected 2040 (Population in Thousands).**

Figure 69 provides a similar view of relative population center size and distance with routing through College Station. The corridor would be approximately 200 miles in length with a total of three metropolitan CBSAs. According to the 2000 Census, the Houston CBSA contained over 4.7 million people; and the Austin CBSA contained over 1.2 million people. Figure 69 also shows the census population estimates for 2008 and projected population for 2040 according to the Texas State Demographer.





**Figure 69. Houston to Austin Corridor Population and Distance in 2000, 2008 Estimates, and Projected 2040 (Population in Thousands).**

### Market Potential

This section demonstrates several demographic and roadway travel statistics for the Houston to Austin Corridor in order to exhibit the relative need for rail in the corridor. Projected population numbers are based on estimates developed by the Texas State Demographer, while the roadway information comes from the TxDOT’s Road–Highway Inventory Network (RHINO) database and the FHWA Freight Analysis Framework database.

#### *Population, Economic Activity, and Special Generators*

The Houston to Austin Corridor along US 290 has two major metropolitan CBSAs for end points and also passes through the Brenham micropolitan CBSA and, if routed through College Station/Bryan connects three metropolitan CBSAs. The total population along the US 290 corridor CBSAs is 5.9 million people, as measured in 2000, and is expected to reach 11.0 million people by 2040, as shown in [Table 39](#). Most of the growth is anticipated in the two urban centers at the ends of the corridor; however slower, but still substantial, growth is projected to occur at smaller intermediate urban locations. The population per mile is expected to almost double from 36,782 people per mile along the corridor in 2000 to 68,086 people per mile in 2040 for the primary US 290 corridor.

A noticeable trend along the corridor is the growth in the expected population over 65 years of age. In 2000, the percentage of the total corridor population over 65 years of age was 7.7 percent, while in 2040 that percentage is expected to be increase to 18.3 percent of the total corridor population. While similar growth trends for this age group are anticipated on other Texas corridors, this growth rate represents an important potential market segment for rail ridership in the Houston to Austin Corridor.

Over 150,000 employment establishments along the corridor in 2005 employed over 2.5 million persons. The number and nature of employment growth that could be served by a HrSR or HSR service would be an important part of the analysis undertaken by this study. The Austin and Houston areas are also home to major university systems such as the University of

Texas at Austin and the University of Houston. If the College Station route is chosen, Texas A&M University would also be linked by the corridor. Several additional smaller public and private universities and colleges also lie along the corridor. The total higher education enrollment for the corridor in 2006 was 173,438 students not including Texas A&M, which would add 45,000 to 50,000 additional students.

**Table 39. Houston to Austin Demographic Data from TxDOT Project 0-5930.**

| Data Element  | Houston to Austin |
|---|-------------------|
| Population  |                   |
| 2000  | 5,995,543         |
| 2040  | 11,098,155        |
| Population per Mile*                                      |                   |
| 2000  | 36,782            |
| 2040  | 68,086            |
| Population – Over 65 Years of Age                         |                   |
| 2000  | 463,114           |
| 2040  | 2,031,180         |
| Employment  |                   |
| No. of Employees (2005)                                   | 2,593,949         |
| No. of Employer Establishments (2005)                     | 151,395           |
| Total Public or Private University Enrollment (Fall 2006) | 173,438           |

\*Calculation using corridor length = 163 miles

*Corridor Travel Patterns: Commercial Air Carrier Service*

The existing commercial airports within the Houston to Austin Corridor include Austin-Bergstrom International Airport (AUS), Easterwood Airport (CLL), Houston’s William P. Hobby Airport (HOU), and Houston George Bush Intercontinental Airport (IAH). The air service market distance between HOU and AUS is 148 miles, between CLL and IAH is 74 miles, and between IAH and AUS is 140 miles. In 2006, the total number of air trips between Houston and Austin was 217,520, which is a 6.9 percent decrease compared to 1996. Between 1996 and 2008, specific indices for the air travel demand for Houston to Austin Corridor are shown in [Table 40](#).

**Table 40. Air Travel Demand for Corridor Houston-Austin from 1996 to 2008.**

| Year                           | Number of Flights | Number of Passengers | Number of Seats | Load Factor |
|--------------------------------|-------------------|----------------------|-----------------|-------------|
| 1996                           | 15,439            | 1,176,925            | 1,942,879       | 0.61        |
| 2008                           | 12,032            | 1,128,924            | 1,652,443       | 0.68        |
| 1996–2008<br>(Annual % change) | –1.70%            | –0.31%               | –1.15%          | 0.98%       |

Air carrier data for the Houston-Austin Corridor in the original intercity corridor evaluation in Project 0-5930 did not include College Station Easterwood Airport (CLL). Including 2008 air passenger activity at CLL, 16,606 flights traversed the Houston-Austin Corridor, carrying 1,185,437 passengers with a load factor of 0.67.



In 2006, the average number of scheduled flights per day on the corridor between Houston and Austin was 35 flights per day. Houston to College Station averaged approximately 45 flights per day. In Texas, nearly 71 million passengers were enplaned in 2007, and the number is expected to grow to more than 104 million per year by 2025. Houston George Bush Intercontinental and Houston’s William P. Hobby airports are among the four biggest airports in Texas that along with Dallas/Fort Worth International and Dallas Love Field accounted for 81 percent of total enplanements in 2007.

*Corridor Travel Patterns: Highway*

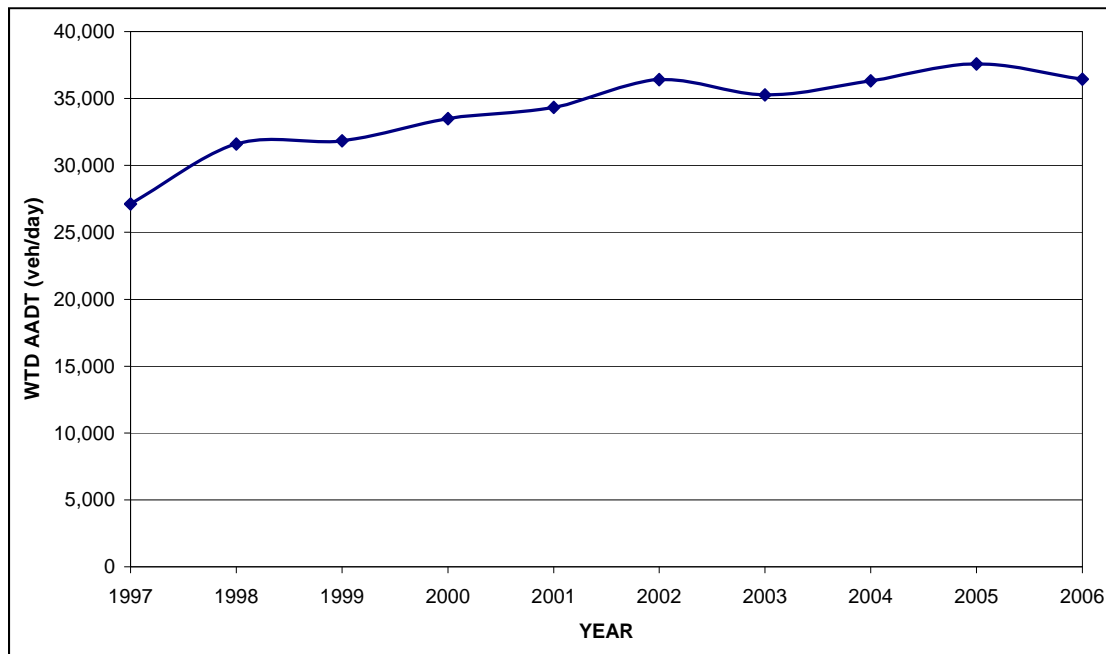
The heavily traveled US 290 route carried over 36,000 vehicles per day in 2006, as a result of a 3.44 percent annual growth between 1997 and 2006 as shown in [Table 41](#). [Figure 70](#) demonstrates the 10-year growth in traffic for the Houston to Austin Corridor. The projected average annual daily traffic (AADT) levels, derived from the FHWA FAF database, are expected to reach over 109,000 vehicles per day in 2035—an almost three-fold increase.

The overall weighted average V/C ratio for the corridor in 2002 was 0.60, with a 1.0 representing a roadway at capacity. The sections located in or near Austin and Houston are the most traveled, while the vast majority of the corridor located in rural areas. The 2035 projected V/C ratio worsens to an expected value of 1.68. This is shown in the 2002 and 2035 estimated corridor average speed over the corridor on US 290 dropping from 52 mph in 2002 to only 29 mph in 2035 based on these numbers. Finally, the percent trucks along the corridor was 10.95 percent in 2002 and is forecast to increase slightly to 11.25 percent in 2035. Since the AADT is forecast to almost triple, the number of trucks will do the same in order to maintain the same relative percentage.

[Table 41](#) shows the highway travel statistics, and [Figure 70](#) shows the 10-year weighted AADT trend.

**Table 41. Houston to Austin Highway Travel Patterns via US 290.**

| <b>Data Element</b>   | <b>DFW to Houston</b>                               |
|---|---|
| % Annual Growth in Average Corridor AADT (1997–2006)            | 3.44%   |
| Average Corridor AADT<br>2006<br>2035 (FAF forecast)            | 36,441 vehicles per day<br>109,037 vehicles per day |
| Average Volume-to-Capacity Ratio<br>2002<br>2035 (FAF forecast) | 0.60<br>1.68  |
| Average Speed<br>2002<br>2035 (FAF forecast)                    | 52 mph<br>29 mph                                    |
| Average % Trucks<br>2002<br>2035 (FAF forecast)                 | 10.95%<br>11.25%                                    |



**Figure 70. Houston to Austin via US 290 10-Year Weighted AADT, 1997–2006.**

## Environmental Quality

### *Currently Designated Nonattainment Areas in Texas for All Criteria Pollutants*

As of January 6, 2010, the eight counties in the Houston area (Brazoria, Chambers, Fort Bend, Galveston, Harris, Liberty, Montgomery, and Waller) are designated as severe nonattainment for 8-Hr Ozone by the EPA. In central Texas, the Austin-Round Rock area and the San Antonio area signed Early Action Compact (EAC) agreements with the EPA in 2004 to avoid being designated non-attainment areas. The Austin-Round Rock area demonstrated attainment in 2004 and San Antonio did so in 2008. The two areas engage in continuous efforts to maintain air quality conformity while the threat of not achieving it is always looming, especially in light of significant urban growth. EPA proposals to change the defined limits for measuring various pollutants also put the Austin area at risk of entering non-attainment. [Figure 66](#) shows the Texas non-attainment areas.

## Passenger Rail, Bus Transit, Air Services, and Freight Rail

The following sections summarize the existing transit and freight rail services and routes in the study corridor area.

### *Existing Intercity Passenger Rail Service*

No existing passenger rail service is currently available directly on this corridor. The Amtrak Sunset provides service between Houston and San Antonio three days a week, and the Texas Eagle serves Austin daily on a north-south route between San Antonio and Chicago, Illinois. Capital Metro began its Austin Commuter Rail Red Line service in March 2010 serving

Austin and several smaller suburbs north of the city. Several studies have been completed in the last decade regarding development of commuter rail service over a roughly 100-mile corridor between Austin and San Antonio. More recent studies have examined commuter rail possibilities on both the east end of the proposed study corridor and along US 290 between Hempstead, Texas, and Houston. These projects are in various stages of development. This route could potentially serve as a heavily used hurricane evacuation route for the Houston area, as Austin is designated as a primary evacuation area for the Houston population when threatened by tropical weather systems.

### *Existing Bus Service*

Greyhound Lines, Inc. runs one bus daily between Houston and Prairie View, Texas—approximately 40 miles on the western end of the corridor. The Kerrville Bus Company provides interlined service with Greyhound four times daily between Houston and Austin on US 290 and one time daily linking Houston and Austin via I-10 and US 71 (rather than US 290). Arrow Trailways of Texas runs an indirect route one time daily over parts of the proposed study corridor. It serves one trip per day both between Waco and Killeen and between Killeen and Houston.

### *Intermodal Facilities*

Intermodal facilities include passenger train stations, bus stops/stations, transit centers, and other facilities that could potentially become intermodal facilities if market demands and development allows. On the Houston to Austin Corridor, specific facilities are as follows:

- Austin Greyhound station,
- Austin Amtrak station,
- Bryan Greyhound station,
- CARTS Central Terminal in Austin,
- Houston Amtrak thruway bus station,
- Houston Greyhound station,
- Round Rock CARTS intermodal facility, and
- Planned or proposed: Houston Northern intermodal facility.

### *Transit Agencies*

The corridor of Houston to Austin goes through two planning regions. There are seven existing transit agencies connecting to the corridor, namely:

- Capital Metropolitan Transit Authority - Austin, Texas (Capital Metro),
- Capital Area Rural Transportation System (CARTS),
- Gulf Coast Center's Connect Transportation,
- Fort Bend County Transit,

- Metropolitan Transit Authority of Harris County Houston Texas (METRO), and
- The District (Brazos Transit).

*Existing Freight Rail Operations*

There is no existing direct freight rail line between Houston and Austin. There are two relatively direct existing freight rail routes between Houston and Austin. Both involve utilizing the Burlington Northern Santa Fe (BNSF) rail line to Sealy, Texas, from Houston. At Sealy, the UP line from Sealy to Smithville and Lockhart would be traversed. At Lockhart, trains can go either north to Taylor then southwesterly to Austin or continue west from Lockhart to San Marcos, then north to Austin. Table 42 represents the current train volumes provided by the Class I railroads and as determined through various freight rail mobility studies conducted by TxDOT. Future train volumes per rail line segment are based on a 3 percent annualized growth rate.

**Table 42. Freight Rail Segment Density and Rail Volumes.**

| Segment              | Current Volume (trains per day) | Projected 2035 Volume (trains per day) | Growth (trains per day) | Percent Growth | Segment Density (MGTM/Mi) |
|----------------------|---------------------------------|--|-------------------------|----------------|---------------------------|
| Houston to Sealy     | 30-35                           | 75-85                                  | 45-50                   | 140-150        | 50-55                     |
| Sealy to Smithville  | 10-15                           | 30-40                                  | 20-25                   | 150-200        | 20-25                     |
| Smithville to Taylor | 5-10                            | 20-30                                  | 15-20                   | 200-300        | 5-10                      |
| Taylor to Austin     | 25-30                           | 60-75                                  | 35-45                   | 140-150        | 30-35                     |

Table 43 shows the current (2007) and future (2035) levels-of-service along the existing freight rail corridor as stated in the *National Rail Freight Infrastructure Capacity and Investment Study (2007)*.

**Table 43. Current and Future Levels-of-Service (Houston to Austin).**

| Segment          | Current LOS | Future LOS - Unimproved | Future LOS - Improved |
|------------------|-------------|-------------------------|-----------------------|
| Houston to Sealy | D           | F                       | A, B, C               |
| Sealy to Taylor  | A, B, C     | E                       | A, B, C               |
| Taylor to Austin | A, B, C     | F                       | A, B, C               |

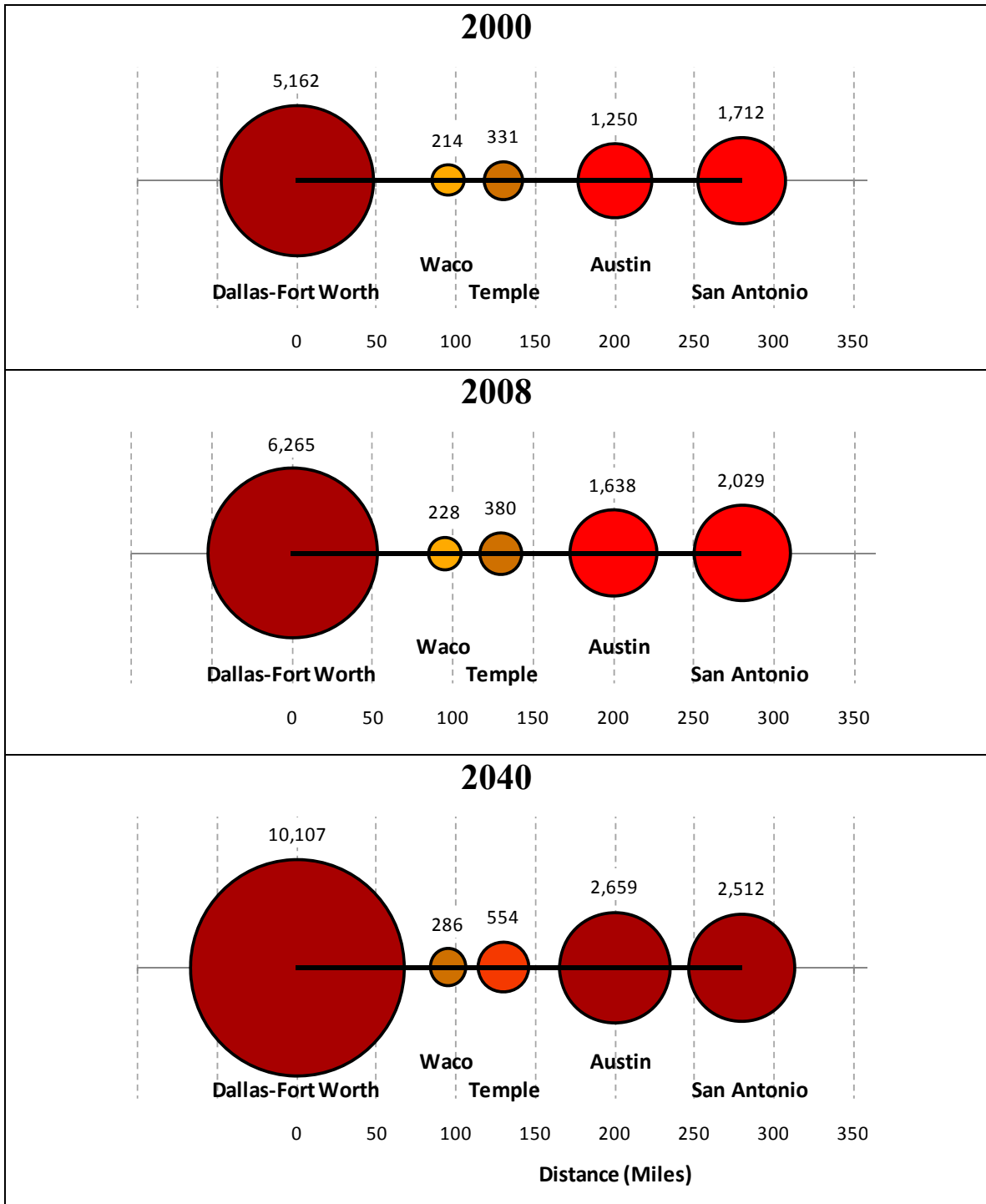
On the proposed study corridor linking Houston and Austin, several current and former freight rail segments exist. The Capital Metropolitan Transportation Authority (Capital Metro) in Austin owns a rail line that travels parallel to US 290 from Llano, Texas (west of Austin), to Giddings, Texas, approximately 50 miles east of the city. Capital Metro acquired the line from the City of Austin and has recently begun operating commuter rail service over segments of the line within the urban core. A 2008 study by Capital Metro recommended future development of another commuter rail line along this segment as far as Elgin, Texas; however, significant investment would be required to bring the tracks in this segment into repair for any type of passenger rail service.

Between Giddings and Hempstead, Texas, is approximately 50 miles of abandoned railroad corridor where the tracks have been removed and the ROW has reverted largely to adjacent landowners. Segments between Hempstead and Brenham, Texas, were abandoned in 1961 and 1962, while the segment between Brenham and Giddings was abandoned in 1979. From Hempstead into Houston, Union Pacific Railroad owns and operates its Eureka Subdivision parallel to US 290. UP has expressed willingness to explore commuter rail service in this corridor during past studies by both TxDOT and the Houston-Galveston MPO, but HrSR and/or HSR may not be compatible with their freight operations in this corridor. A study is needed to make that determination and to consider other possible entry routes into the Houston urban area.

## **DALLAS TO SAN ANTONIO AND SAN ANTONIO TO BROWNSVILLE VIA LAREDO CORRIDOR OVERVIEW**

Figure 71 shows of the CBSA populations along the Dallas-Fort Worth to San Antonio Corridor, along with a demonstration of the distance between these urban centers. The corridor is approximately 280 miles in length with a total of five CBSAs, all of which are categorized as metropolitan. According to the 2000 Federal Census, over 5.1 million people resided in the Dallas-Fort Worth-Arlington CBSA, while the populations of both the Austin-Round Rock and San Antonio CBSAs exceed 1.2 and 1.7 million, respectively. The Waco and Killeen-Temple-Fort Hood CBSAs added over 500,000 combined population to the corridor.

In addition to the 2000 population figures, Figure 71 contains the 2008 population estimates and the expected 2040 population for all five CBSAs along the corridor as forecast by the Texas State Demographer. The major urban centers along the corridor are expected to experience significant population growth by 2040, with the Dallas-Fort Worth-Arlington CBSA expecting to almost double to over 10 million people in 2040. The Austin-Round Rock CBSA is expected to surpass the San Antonio CBSA to over 2.6 million people in 2040. The San Antonio CBSA is expected to grow to 2.5 million, while the Waco and Killeen-Temple-Fort Hood CBSAs are expected to grow to over 286,000 and 554,000, respectively. The Corsicana and Huntsville CBSAs are expected to reach 70,900 and 77,800, respectively, by 2040.



**Figure 71. Dallas to San Antonio Corridor Population Distribution (Population in Thousands).**

Table 44 shows the distance between the urban areas along the corridor and estimated travel time at a variety of average passenger rail speeds along the entire corridor.

**Table 44. Dallas-Fort Worth to San Antonio CBSA Population, Distances, and Estimated Travel Times.**

| CBSA        | Population |           |            | Distance |            | Travel Time (hours:minutes) |        |         |         |         |
|-------------|------------|-----------|------------|----------|------------|-----------------------------|--------|---------|---------|---------|
|             | 2000       | 2008      | 2040       | Segment  | Cumulative | 60 mph                      | 80 mph | 110 mph | 150 mph | 200 mph |
| DFW         | 5,161,500  | 6,265,000 | 10,106,800 | 0        | 0          | 0:00                        | 0:00   | 0:00    | 0:00    | 0:00    |
| Waco        | 213,500    | 228,500   | 285,500    | 95       | 95         | 1:35                        | 1:11   | 0:51    | 0:38    | 0:28    |
| Temple      | 330,700    | 379,800   | 553,700    | 35       | 130        | 2:10                        | 1:37   | 1:10    | 0:52    | 0:39    |
| Austin      | 1,249,800  | 1,637,900 | 2,658,500  | 70       | 200        | 3:20                        | 2:30   | 1:49    | 1:20    | 1:00    |
| San Antonio | 1,711,700  | 2,028,800 | 2,512,000  | 80       | 280        | 4:40                        | 3:30   | 2:32    | 1:52    | 1:24    |

### Market Potential

The market potential of a high-speed intercity passenger rail corridor can be measured by the proposed corridor’s population, density, economic activity, and travel patterns. This section reports several demographics and travel activity statistics for the Dallas-Fort Worth to San Antonio Corridor. Projected population numbers are presented by the Texas State Demographer, while the roadway information comes from the TxDOT Road–Highway Inventory Network (RHINO) database and FHWA Freight Analysis Framework database.

#### *Population, Economic Activity, and Special Generators*

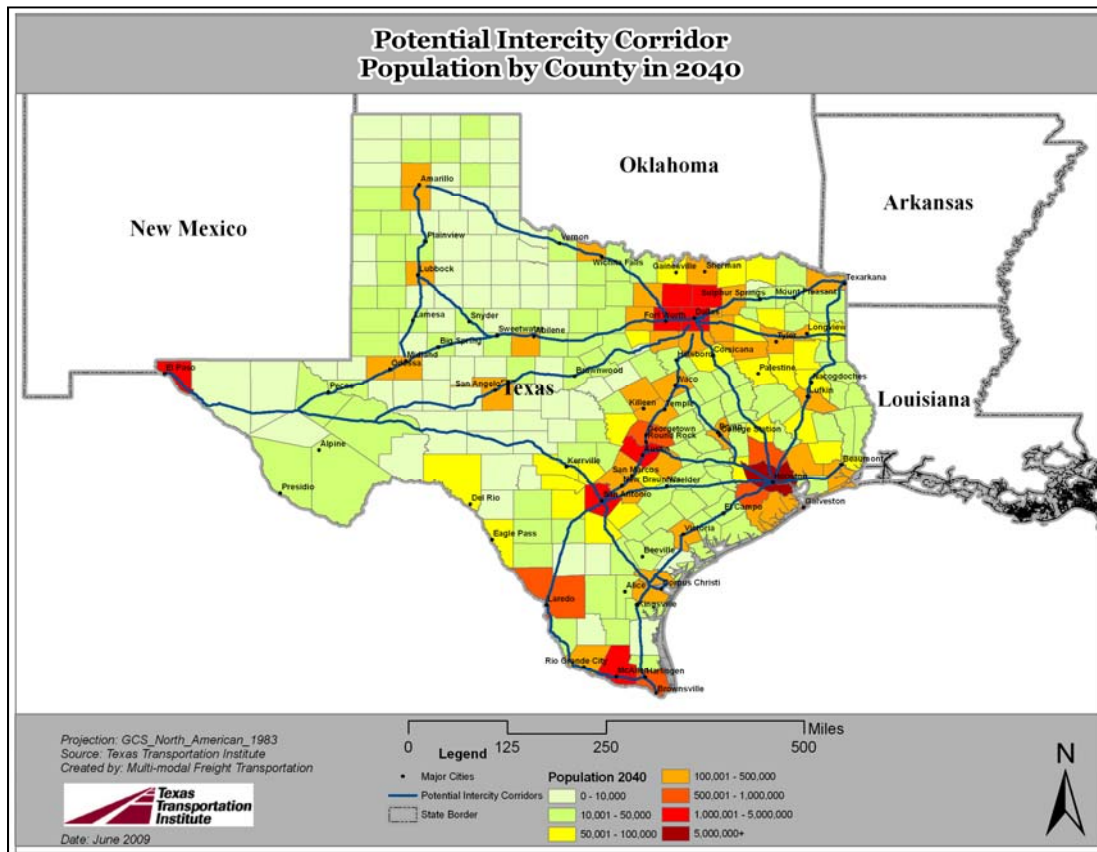
The Dallas-Fort Worth to San Antonio Corridor is the most densely populated and fastest growing corridor in Texas. The combined corridor population was approximately 8.6 million people in 2000 and is projected to reach over 16 million by 2040, as shown in [Table 45](#). The population numbers translate to a 2000 population per mile value of 32,461 but are expected to almost double to 60,361 people per mile along the corridor by 2040. [Figure 72](#) shows the high population levels along the I-35 corridor between the Texas-Oklahoma border and San Antonio.

A larger portion of the population along the I-35 corridor in 2040 is expected to consist of individuals over 65 years of age. In 2000, the percentage of population was in this demographic category was 8.5 percent, but that is expected to rise to 18.6 percent (or over 3 million people) by 2040. [Table 45](#) also shows that there were over 3.9 million employees along the corridor working at 219,000 establishments based on 2005 figures. Finally, the combined higher education enrollment at institutions along the route exceeded 280,000 in 2006. Collectively, these three traveler groups—the elderly, business persons, and college students—comprise a large potential market for high-speed intercity passenger rail service in this corridor.

**Table 45. Dallas-Fort Worth to San Antonio Demographics.**

| Data Element  | DFW to San Antonio |
|---|--------------------|
| Population  |                    |
| 2000  | 8,667,241          |
| 2040  | 16,116,530         |
| Population per Mile*                                      |                    |
| 2000  | 32,461             |
| 2040  | 60,361             |
| Population - Over 65                                      |                    |
| 2000  | 737,059            |
| 2040  | 3,001,173          |
| Employment  |                    |
| No. of Employees (2005)                                   | 3,908,853          |
| No. of Employer Establishments (2005)                     | 219,844            |
| Total Public or Private University Enrollment (Fall 2006) | 280,359            |

\*Calculation using corridor length = 267 miles



**Figure 72. Texas Population by County, 2040.**



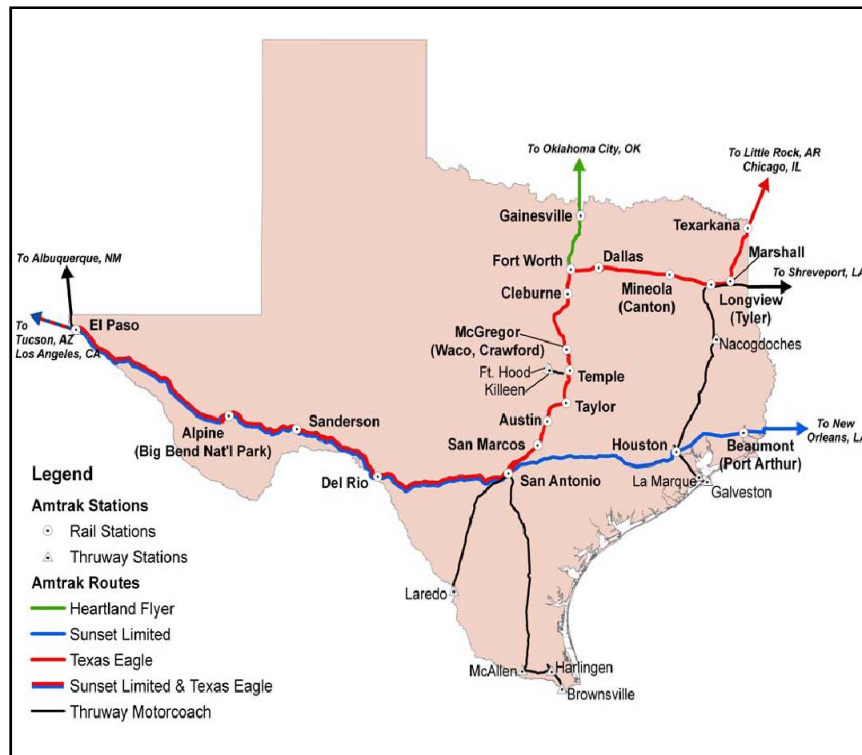
Following I-35 north from Dallas-Fort Worth to the Texas-Oklahoma border would travel primarily through Cooke County, Texas, which is a designated micropolitan CBSA, named the Gainesville CBSA. Although not included in the original 0-5930 research project, considering the Gainesville CBSA as part of the combined Dallas-Fort Worth CBSA adds the following demographic data, as presented in [Table 46](#).

**Table 46. Gainesville CBSA Demographics.**

| <b>Data Element</b>                   | <b>DFW to San Antonio</b> |
|---------------------------------------|---------------------------|
| Population                            |                           |
| 2000                                  | 36,363                    |
| 2040                                  | 46,490                    |
| Population - Over 65                  |                           |
| 2000                                  | 5,415                     |
| 2040                                  | 10,427                    |
| Employment                            |                           |
| No. of Employees (2005)               | 10,682                    |
| No. of Employer Establishments (2005) | 870                       |

*Corridor Travel Patterns: Intercity Passenger Rail*

[Figure 73](#) shows the Amtrak intercity passenger rail routes in Texas, which includes the two routes that serve the corridor, the *Heartland Flyer* and the *Texas Eagle*. The *Heartland Flyer* line operates between Fort Worth and Oklahoma City, Oklahoma, once daily in each direction with southbound in the morning and returning northbound in the evening. The *Texas Eagle* operates daily between Chicago, Illinois, and San Antonio, and 3 days per week between Chicago and Los Angeles in conjunction with the *Sunset Limited*. Stations west of San Antonio are served on the same schedule as the *Sunset Limited*. Amtrak Thruway Motorcoach connections are provided to Ft. Hood and Killeen via Temple as well as to Brownsville and Laredo via San Antonio. In addition to the Amtrak services shown in [Figure 73](#), the Trinity Railway Express and Austin Commuter Rail systems provide intercity rail service between Dallas and Fort Worth and Austin and several northern suburbs, respectively. For over a decade, efforts have been under way to develop a commuter rail system between Austin and San Antonio on or alongside the UP freight line connecting the two cities.



**Figure 73. Amtrak Routes and Stations in Texas.**

Table 47 displays the 3-year ridership totals for the three Amtrak routes in Texas—the *Heartland Flyer*, the *Sunset Limited*, and the *Texas Eagle*. Note that the annual ridership totals are reported for the federal fiscal year (FFY), which starts October 1. Ridership on the *Heartland Flyer* in FFY 2009 was approximately 10 percent less than FFY 2008, reflecting a general nationwide trend of lower Amtrak ridership in FFY 2009 due to the economic recession impacting travel patterns. However, ridership on the two Amtrak long-distance routes in Texas, the *Sunset Limited* and the *Texas Eagle*, were opposite of the national trend, with ridership gains realized in FFY 2009 compared with FFY 2008. All three Texas routes realized ridership gains in FFY 2009 as compared to FFY 2007.

**Table 47. Amtrak Texas Routes Ridership, FFY 2007–2009.**

| Route           | Ridership |          |          | Percent Change |              |
|-----------------|-----------|----------|----------|----------------|--------------|
|                 | FFY 2009  | FFY 2008 | FFY 2007 | vs. FFY 2008   | vs. FFY 2007 |
| Heartland Flyer | 73,564    | 80,892   | 68,246   | -9.1           | +7.8         |
| Sunset Limited  | 78,775    | 71,719   | 63,336   | +9.8           | +24.4        |
| Texas Eagle     | 260,467   | 251,518  | 218,321  | +3.6           | +19.3        |

Table 48 displays the total ridership activity for Amtrak stations along the corridor for FFY 2007, 2008, and 2009. Ridership activity at a given station consists of the count of passengers boarding trains at the station plus the count of passengers alighting trains at the station. During FFY 2009, almost 325,000 passengers connected to Amtrak trains at stations along the corridor, a slight decrease from FFY 2008 but a 20 percent increase from FFY 2007.

Passenger activity at corridor stations in Texas increased slightly in FFY 2009 (as compared with FFY 2008) and increased 24 percent compared with FFY 2007.

**Table 48. Corridor Amtrak Stations – Boardings and Alightings, FFY 2007–2009.**

| Station                   | Ridership             |                       |                       | Percent Change     |                     |
|---------------------------|-----------------------|-----------------------|-----------------------|--------------------|---------------------|
|                           | FFY 2009              | FFY 2008              | FFY 2007              | vs. FFY 2008       | vs. FFY 2007        |
| <b>Oklahoma</b>           |                       |                       |                       |                    |                     |
| Ardmore                   | 9,094                 | 8,607                 | 9,642                 | +5.7               | -5.7                |
| Norman                    | 12,573                | 13,414                | 11,033                | -6.3               | +14.0               |
| Oklahoma City             | 48,434                | 55,015                | 43,293                | -12.0              | +11.9               |
| Pauls Valley              | 5,393                 | 5,942                 | 6,357                 | -9.2               | -15.2               |
| Purcell                   | 2,073                 | 2,086                 | 2,801                 | -0.6               | -26.0               |
| <i>Oklahoma Total</i>     | <i>68,473</i>         | <i>76,457</i>         | <i>63,484</i>         | <i>-10.4</i>       | <i>+7.9</i>         |
| <b>Texas</b>              |                       |                       |                       |                    |                     |
| Austin                    | 25,404                | 23,829                | 19,388                | +6.6               | +31.0               |
| Cleburne                  | 2,455                 | 2,135                 | 1,831                 | +15.0              | +34.1               |
| Dallas                    | 39,592                | 35,860                | 27,374                | +10.4              | +44.6               |
| Fort Worth                | 104,107               | 109,012               | 85,069                | -4.5               | +22.4               |
| Gainesville               | 8,018                 | 9,249                 | 9,589                 | -13.3              | -16.4               |
| McGregor                  | 4,238                 | 3,141                 | 2,382                 | +34.9              | +77.9               |
| San Antonio               | 48,804                | 48,151                | 40,908                | +1.4               | +19.3               |
| San Marcos                | 4,339                 | 3,741                 | 3,084                 | +16.0              | +40.7               |
| Taylor                    | 3,908                 | 3,981                 | 3,464                 | -1.8               | +12.8               |
| Temple                    | 15,163                | 12,914                | 13,349                | +17.4              | +13.6               |
| <i>Texas Total</i>        | <i>256,028</i>        | <i>252,013</i>        | <i>206,438</i>        | <i>+1.6</i>        | <i>+24.0</i>        |
| <b><i>Grand Total</i></b> | <b><i>324,501</i></b> | <b><i>328,470</i></b> | <b><i>269,922</i></b> | <b><i>-1.2</i></b> | <b><i>+20.2</i></b> |

Table 49 reports the five largest city pairs by Amtrak ridership in the corridor for the time period between September 2006 and August 2007. A vast majority of the intercity passenger rail travel patterns flow along the *Heartland Flyer* route endpoints, with more than 35,000 passengers along this segment of the corridor.

**Table 49. Five Largest Amtrak Intercity Passenger City-Pairs with at Least One Endpoint in Texas for the Period September 2006–August 2007.**

| Train                  | Station Codes | Station Names                       | Ridership |
|------------------------|---------------|-------------------------------------|-----------|
| <i>Heartland Flyer</i> | FTW-OKC       | Fort Worth, TX - Oklahoma City, OK  | 35,663    |
| <i>Heartland Flyer</i> | FTW-NOR       | Fort Worth, TX - Norman, OK         | 7,924     |
| <i>Texas Eagle</i>     | FTW-SAS       | Fort Worth, TX - San Antonio, TX    | 7,192     |
| <i>Texas Eagle</i>     | AUS-FTW       | Austin, TX - Fort Worth, TX         | 5,721     |
| <i>Heartland Flyer</i> | GLE-OKC       | Gainesville, TX - Oklahoma City, OK | 3,675     |

*Corridor Travel Patterns: Commercial Air Carrier Service*

The existing commercial airports within the Dallas-Fort Worth to San Antonio Corridor include Dallas/Fort Worth International (DFW), Dallas Love Field (DAL), Waco Regional Airport (ACT), Killeen-Fort Hood Robert Gray AAF (GRK), Austin-Bergstrom International Airport (AUS), and San Antonio International Airport (SAT). While not specifically included in the 0-5930 project corridor evaluation, the airport in Oklahoma City, the Oklahoma City Will Rogers World Airport (OKC), is included in the scope of the proposed high-speed rail corridor. The longest corridor air market distance is between SAT and OKC, at just over 400 miles. The air travel distance between the two DFW-region airports and SAT is approximately 250 miles. In 2006, the total number of air trips between Dallas/Fort Worth and San Antonio was 1,407,110, which is a 1.24 percent decrease compared to 1996. Between 1996 and 2008, specific indices for the air travel demand for Dallas/Fort Worth to San Antonio Corridor are shown in [Table 50](#).

**Table 50. Air Travel Demand for Corridor Dallas/Fort Worth – San Antonio from 1996 to 2008 (Not Including DFW-OKC).**

| Year                                 | Number of Flights | Number of Passengers | Number of Seats | Load Factor |
|--------------------------------------|-------------------|----------------------|-----------------|-------------|
| 1996                                 | 66,155            | 4,779,512            | 7,016,205       | 0.68        |
| 2008                                 | 52,473            | 4,476,962            | 6,031,329       | 0.74        |
| 1996–2008<br>(Annual percent change) | –1.59%            | –0.49%               | –1.08%          | 0.69%       |

In 2006, the average number of scheduled flights on the corridor between Dallas/Fort Worth and San Antonio was 155 flights per day. In Texas, nearly 71 million passengers were enplaned in 2007, and the number is expected to grow more than 104 million per year by 2025. Adding estimated air travel activity from OKC to the activity at the other corridor airports, the 2008 traffic patterns total 69,249 flight operations and 5,780,839 passengers carried. Also, it is estimated from 2008 air traffic data that approximately 14 percent of all commercial air carrier flight operations at corridor airports were operating between two airports in the corridor. Development of a high-speed intercity passenger rail system may reduce this percentage by diverting corridor trips from air to high-speed rail, which would in turn increase capacity and operational efficiency at corridor airports.

*Corridor Travel Patterns: Highway*

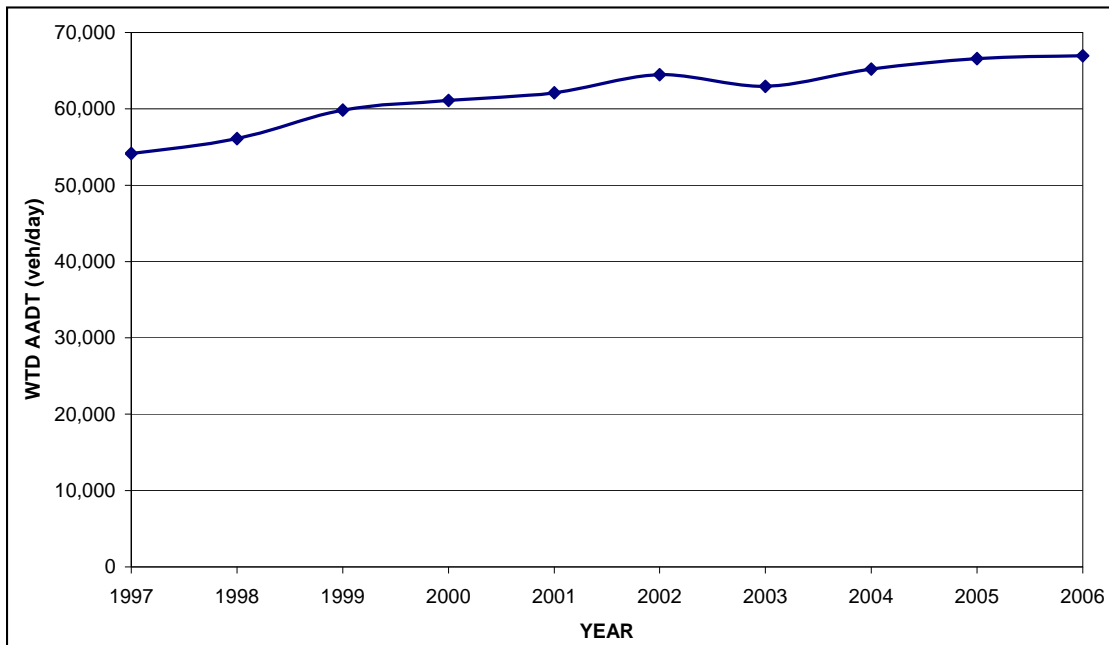
I-35 is one of the busiest highways in the United States. The major urban centers experience high levels of passenger traffic, not only internally but also between urban areas. I-35 is also a vital link for international trade with Mexico, bringing goods from Mexico into the Midwestern United States or to the industrial centers of the U.S. East Coast. The highway is the major transportation method along this corridor, and TxDOT has spent millions of dollars over the past several decades widening and improving safety for its entire length within the state.

[Table 51](#) shows the highway travel statistics. Traffic levels on I-35 between Dallas-Fort Worth and San Antonio grew 2.9 percent annually on a weighted average basis between 1997 and 2006 as shown in [Figure 74](#). The levels are expected to grow from 88,000 in 2006 to over 178,000 vehicles per day in 2035 as shown in [Table 51](#). The overall corridor volume-to-capacity ratio in 2002 was 0.80, with a 1.0 representing a roadway at capacity. The 2035 projected V/C

ratio worsens to an expected value of 1.90. This is shown in the 2002 and 2035 estimated average speed over the corridor dropping from 55 mph in 2002 to 15 mph in 2035. The percentage of trucks along the corridor is expected to remain relatively steady to 2035. Figure 74 shows the trend line for growth in AADT from 1997 to 2006.

**Table 51. Dallas-Fort Worth to San Antonio Highway Travel Patterns.**

| Data Element   | DFW to San Antonio       |
|--|--------------------------|
| % Annual Growth in Average Corridor AADT (1997–2006) | 2.91%                    |
| Average Corridor AADT                                |                          |
| 2006   | 88,153 vehicles per day  |
| 2035   | 178,452 vehicles per day |
| Average Volume-to-Capacity Ratio                     |                          |
| 2002   | 0.80                     |
| 2035   | 1.90                     |
| Average Speed  |                          |
| 2002   | 55 mph                   |
| 2035   | 15 mph                   |
| Average % Trucks                                     |                          |
| 2002   | 16.1%                    |
| 2035   | 16.8%                    |



**Figure 74. Dallas-Fort Worth to San Antonio 10-Year Weighted AADT Trend.**

## **Environmental Quality**

### *Currently Designated Nonattainment Areas in Texas for All Criteria Pollutants*

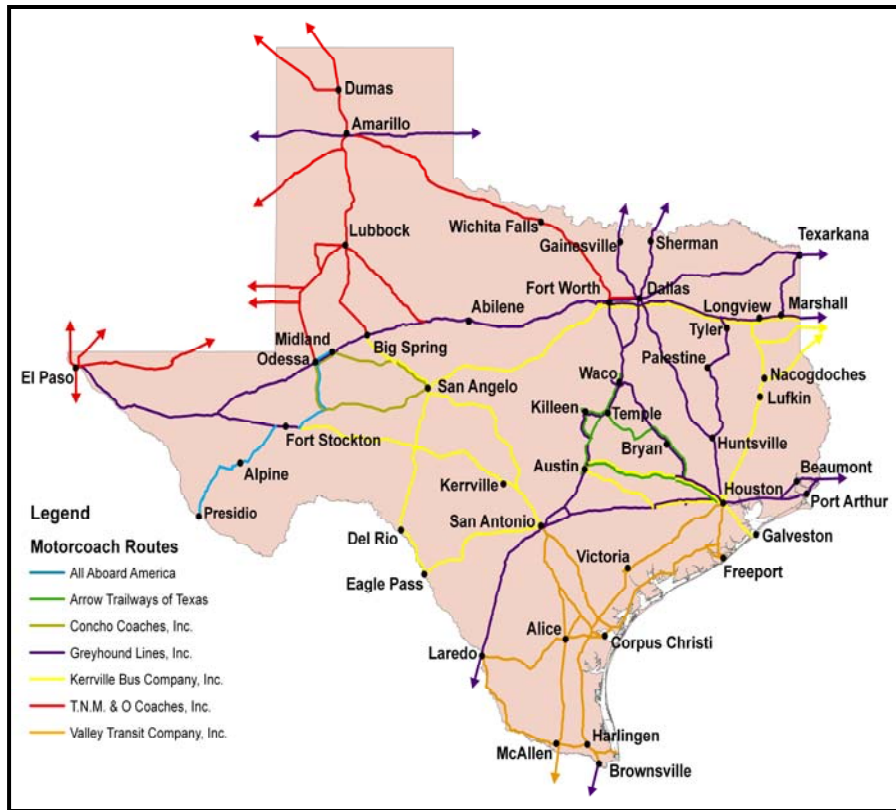
As of January 6, 2010, the nine counties in the Dallas/Fort Worth area (Collin, Dallas, Denton, Ellis, Johnson, Kaufman, Parker, Rockwall, and Tarrant) are designated as moderate nonattainment for 8-Hr Ozone by the EPA. [Figure 66](#) shows a map of these counties along with other non-attainment areas in the state. In central Texas, the Austin-Round Rock area and the San Antonio area signed EAC agreements with the EPA in 2004 to avoid being designated non-attainment areas. The Austin-Round Rock area demonstrated attainment in 2004 and San Antonio did so in 2008 and, as a result, they were not designated as non-attainment. These two areas engage in continuous efforts to maintain air quality conformity while the threat of not achieving it is always looming, especially in light of significant urban growth that is currently taking place and expected to continue in the coming decades. EPA proposals to change the defined limits for measuring various pollutants also put the Austin and San Antonio areas at risk of entering non-attainment status in future EPA designations.

### **Existing Bus Transit, Intermodal Facilities, and Freight Rail**

The following sections summarize the existing transit and freight rail services and routes in the study corridor area.

#### *Existing Bus Service*

Greyhound serves cities along this corridor eight times daily. Greyhound makes several stops in the Dallas-Fort Worth vicinity, including Union Station (where it interfaces with the Trinity Railway Express commuter rail, the DART Light Rail system, and Amtrak's Texas Eagle route) and three additional stops in Dallas and two stops in Fort Worth including the Fort Worth Intermodal Station (where it interfaces with both the Amtrak Heartland Flyer and Texas Eagle routes and with the Trinity Railway Express commuter rail). The Kerrville Bus Company also provides intercity interlined service with Greyhound line one time daily from Fort Worth to San Antonio. Another interlined service with Greyhound line is provided by Americanos USA LLC, which runs 10 times daily along the length of the corridor. [Figure 75](#) shows a map of intercity bus service routes operating in Texas. A listing of the Greyhound stations appears in the following section regarding intermodal facilities.



**Figure 75. Intercity Bus Service in Texas.**

*Intermodal Facilities*

Intermodal facilities include passenger train stations, bus stops/stations, transit centers, and other facilities that could potentially become intermodal facilities if market demand and development allows. On the Dallas/Fort Worth to San Antonio Corridor, there are 26 Greyhound stations/stops and 13 Amtrak stations, as well as others. Specific names are as follows:

*Greyhound Stations/Stop (B)*

- |                          |             |
|--------------------------|-------------|
| Arlington                | Garland     |
| Austin                   | Greenville  |
| Bastrop                  | Lewisville  |
| Carrollton               | Mesquite    |
| Corsicana                | Richardson  |
| Dallas                   | Round Rock  |
| Dallas Westmoreland      | San Antonio |
| Dallas South Park & Ride | San Marcos  |
| Dallas West (B)          | Sherman     |

|                      |                                 |
|----------------------|---------------------------------|
| Denton Travel Center | Stephenville                    |
| Dublin Stop          | Terrell                         |
| Fort Worth           | Waxahachie                      |
| Gainesville          | Weatherford Pilot Travel Center |

**Amtrak Stations**

|   |                                     |
|---|-------------------------------------|
| Austin Central Terminal                     | Temple Amtrak station               |
| Cleburne Intermodal Terminal                | Taylor Amtrak station               |
| Dallas Union Station                        | Killeen Arrow Trailways bus station |
| Fort Worth Intermodal Transportation Center | San Marcos intermodal station       |
| McGregor Amtrak station                     | San Antonio Amtrak station          |
|   | Gainesville Amtrak station          |

**Others:**

- Kerrville intermodal facility
- Waco Intermodal Transit Center

*Transit Agencies*

The corridor from Dallas/Fort Worth to San Antonio travels through six planning regions in the state of Texas and contains 14 existing transit agencies. They are namely:

|   |                                      |
|---|--------------------------------------|
| Alamo Area Regional Transit               | Heart of Texas Council of Government |
| Capital Metro (Austin)                    | Rural Transit                        |
| Capital Area Rural Transit System (CARTS) | Hill Country Transit                 |
| Cletran Transportation (Cleburne)         | TAPS Public Transit                  |
| Collin County Area Regional Transit       | The T (Fort Worth)                   |
| Dallas Area Rapid Transit (DART)          | VIA Transit (San Antonio)            |
| Denton County Transportation Authority    | Waco Transit                         |
|   | Waco Streak                          |

*Existing Freight Rail Operations*

Two existing freight rail line routes run parallel to I-35 between DFW and San Antonio. [Table 52](#) shows these potential rail routes. Route Option 1 has three UP-owned segments: from DFW to Waco, from Waco to Austin, and from Austin to San Antonio. Route Option 2 also has



three segments; the first segment from DFW to Temple is owned by BNSF, and the remaining two from Temple to Austin and from Austin to San Antonio are properties of UP.

**Table 52. Freight Rail Segment Ownership.**

| Segment Detail                             | General Description of Rail Lines | Segment RR |
|--|-----------------------------------|------------|
| <b>DFW to San Antonio (I-35), Option 1</b> |                                   |            |
| DFW to Waco                                | Parallels I-35                    | UP         |
| Waco to Austin                             | Parallels I-35                    | UP         |
| Austin to San Antonio                      | Parallels I-35                    | UP         |
| <b>DFW to San Antonio (I-35), Option 2</b> |                                   |            |
| DFW to Temple                              | Parallels I-35                    | BNSF       |
| Temple to Austin                           | Parallels I-35                    | UP         |
| Austin to San Antonio                      | Parallels I-35                    | UP         |

Table 53 represents the current train volumes provided by the Class I railroads and as determined through various freight rail mobility studies conducted by TxDOT. Future train volumes per rail line segment are based on a 3 percent annualized growth rate.

**Table 53. Segment Density and Rail Volumes (Dallas to San Antonio).**

| Segment                                    | Current Volume<br>(trains per day) | Future Volume*<br>(trains per day) | Growth<br>(trains per day) | Percent<br>Growth | Segment<br>Density<br>(MGTM/<br>Mi) |
|--|------------------------------------|------------------------------------|----------------------------|-------------------|-------------------------------------|
| <b>DFW to San Antonio (I-35), Option 1</b> |                                    |                                    |                            |                   |                                     |
| DFW to Waco***                             | 45-50                              | 95-110                             | 55-60                      | 120               | 60-70                               |
| Waco to Temple                             | 7-12                               | 15-25                              | 8-13                       | 100               | 10-15                               |
| Temple to Taylor                           | 5-10                               | 20-30                              | 15-20                      | 200-300           | 10-15                               |
| Taylor to San<br>Marcos                    | 25-30                              | 60-75                              | 35-45                      | 140-150           | 30-35                               |
| San Marcos to San<br>Antonio               | 35-40                              | 85-95                              | 50-55                      | 130-140           | 25-40 ML1<br>25-30 ML2              |
| <b>DFW to San Antonio (I-35), Option 2</b> |                                    |                                    |                            |                   |                                     |
| DFW to Temple                              | 25-30                              | 60-75                              | 35-45                      | 140-150           | 50-70**                             |
| DFW to Waco                                | 45-50                              | 110-120                            | 65-70                      | 140               | 60-70***                            |
| Waco to Temple                             | 7-12                               | 15-25                              | 8-13                       | 100               | 10-15***                            |
| Temple to Taylor                           | 5-10                               | 20-30                              | 15-20                      | 200-300           | 10-15                               |
| Taylor to San<br>Marcos                    | 25-30                              | 60-75                              | 35-45                      | 140-150           | 30-35                               |
| San Marcos to San<br>Antonio               | 35-40                              | 85-95                              | 50-55                      | 130-140           | 25-40 ML1<br>25-30 ML2              |

\*as of year 2035, excluding passenger trains

\*\* on BNSF rail lines

\*\*\* on UPRR rail lines

Table 54 represents the current (2007) and future (2035) levels-of-service as indicated by the *National Rail Freight Infrastructure Capacity and Investment Study (2007)*.

**Table 54. Current and Future Levels-of-Service (Dallas to San Antonio).**

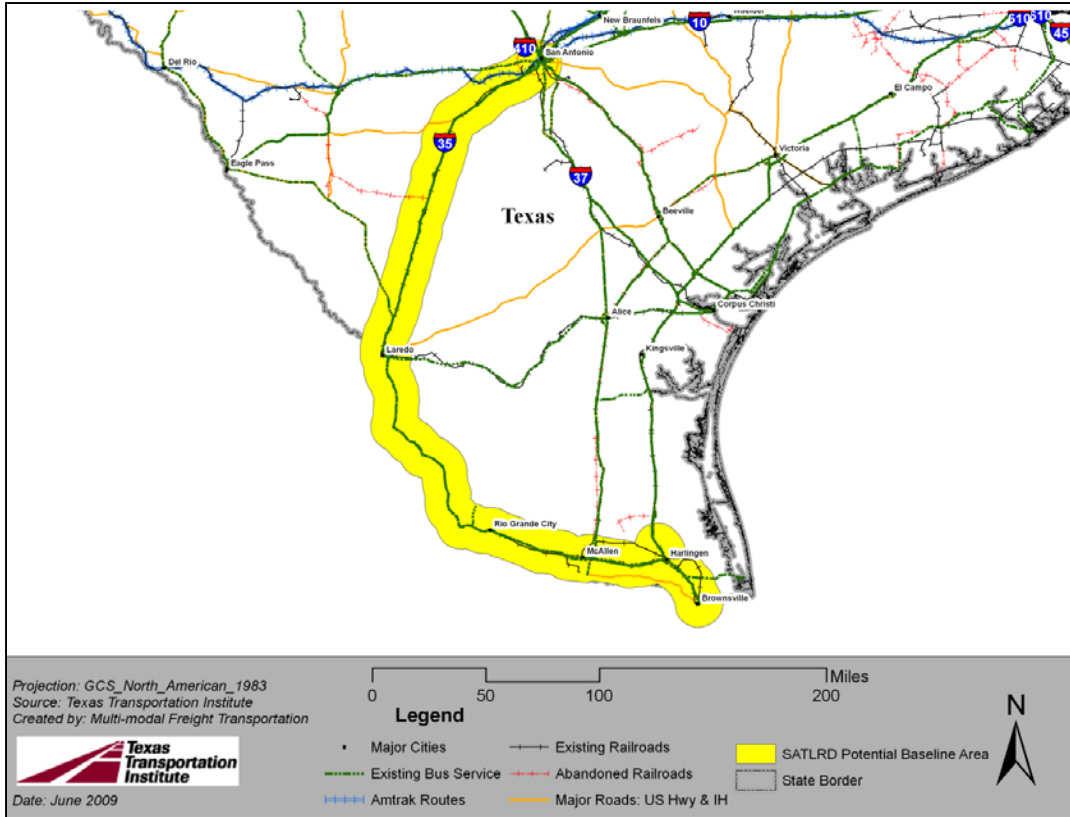
| Segment Detail        | Segment RR | Current LOS | Future LOS - Unimproved | Future LOS – Improved |
|-----------------------|------------|-------------|-------------------------|-----------------------|
| DFW to Waco           | UP         | A, B, C     | E                       | A, B, C               |
| Waco to Austin        | UP         | A, B, C     | F                       | A, B, C               |
| Austin to San Antonio | UP         | D           | F                       | A, B, C               |
| DFW to Temple         | BNSF       | A, B, C     | D                       | A, B, C               |
| Temple to Austin      | UP         | A, B, C     | F                       | A, B, C               |
| Austin to San Antonio | UP         | D           | F                       | A, B, C               |

### **SAN ANTONIO TO BROWNSVILLE VIA LAREDO**

Two route options between San Antonio and the population centers in the lower Rio Grande Valley of the state were examined in TxDOT Project 0-5930. Each is described below in a separate section.

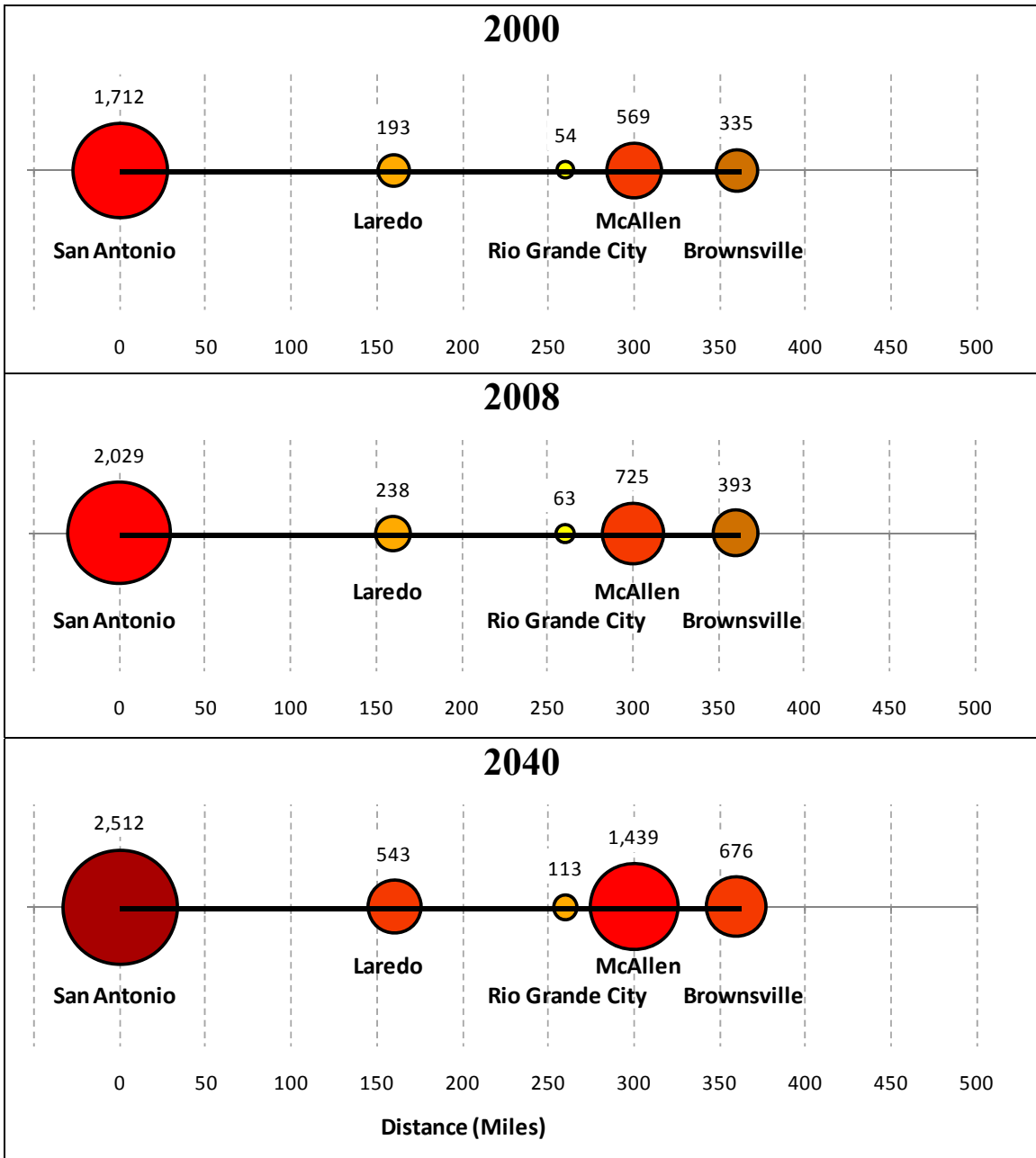
#### **Corridor Overview**

From San Antonio, there are several routes along which to travel to Brownsville. One route travels south from San Antonio along I-35 to Laredo and then along US 83 south through McAllen, Harlingen, and Brownsville. This route captures the major growing urban areas on the Texas-Mexico border. However, no freight rail line exists between Laredo and Rio Grande City, a distance of approximately 100 miles. Figure 76 shows the San Antonio to Brownsville via Laredo Corridor examined in research Project 0-5930.



**Figure 76. San Antonio to Brownsville via Laredo Corridor Map.**

Including the San Antonio CBSA, this corridor captures the Laredo metropolitan CBSA, Rio Grande City-Roma micropolitan CBSA, McAllen-Edinburg-Mission metropolitan CBSA, and Brownsville-Harlingen metropolitan CBSA. [Figure 77](#) provides a view of the CBSA populations along the San Antonio to Brownsville via Laredo Corridor, along with the relative distance between these urban centers.



**Figure 77. San Antonio to Brownsville via Laredo Corridor Population Distribution (Population in Thousands).**

The corridor is approximately 360 miles in length, with the segment between San Antonio and Laredo making up 160 miles and the segment between Laredo and Rio Grande City making up 100 miles. The portion of the corridor between McAllen and Brownsville is fairly close together with several major urban areas.

Both [Figure 77](#) and [Table 55](#) provide the 2000 and 2040 populations of the corridor CBSAs, along with the distances between the urban areas. The San Antonio CBSA is expected to grow from 1.7 million people in 2000 to 2.5 million people in 2040. A tremendous level of

growth is expected for the McAllen-Edinburg-Mission CBSA, with projections of an increase from 569,000 in 2000 to over 1.4 million by 2040. [Table 55](#) also includes estimated travel times based on an average trip speed. Averaging 60 mph the entire trip takes 6 hours, compared to 1 hour, 48 minutes, at 200 mph.

**Table 55. San Antonio to Brownsville via Laredo CBSA Population, Distances, and Estimated Travel Times.**

| CBSA            | Population |           |           | Distance |            | Travel Time (hours:minutes) |        |         |         |         |
|-----------------|------------|-----------|-----------|----------|------------|-----------------------------|--------|---------|---------|---------|
|                 | 2000       | 2008      | 2040      | Segment  | Cumulative | 60 mph                      | 80 mph | 110 mph | 150 mph | 200 mph |
| San Antonio     | 1,711,700  | 2,028,800 | 2,512,000 | 0        | 0          | 0:00                        | 0:00   | 0:00    | 0:00    | 0:00    |
| Laredo          | 193,100    | 238,300   | 542,600   | 160      | 160        | 2:40                        | 2:00   | 1:27    | 1:04    | 0:48    |
| Rio Grande City | 53,600     | 62,600    | 112,700   | 100      | 260        | 4:20                        | 3:15   | 2:21    | 1:44    | 1:18    |
| McAllen         | 569,500    | 725,000   | 1,439,500 | 40       | 300        | 5:00                        | 3:45   | 2:43    | 2:00    | 1:30    |
| Brownsville     | 335,200    | 393,400   | 675,700   | 60       | 360        | 6:00                        | 4:30   | 3:16    | 2:24    | 1:48    |

### Market Potential

This section lists several demographic and roadway travel statistics for the San Antonio to Brownsville via Laredo Corridor. Projected population numbers are presented by the Texas State Demographer, while the roadway information comes from the TxDOT Road–Highway Inventory Network (RHiNo) database and FHWA Freight Analysis Framework database.

#### *Population, Economic Activity, and Special Generators*

The combined population of the five CBSAs was over 2.8 million in 2000 and is expected to grow to over 5.2 million by 2040 as shown in [Table 56](#). Using a corridor length of 349 miles, the population per mile in 2000 was 8,203 people, while that value is expected to grow to over 15,000 by 2040. Additionally, the portion of the population over 65 years of age is expected to grow from 296,645 in 2000 to 858,473 people by 2040. This indicates that the portion of persons older than 65 years of age will increase from 10.3 percent in 2000 to 16.2 percent by 2040. Along the corridor there were an estimated 59,605 establishments that employed over 975,000 people in 2005. Finally, the total higher education enrollment in 2006 was 73,451 students.

**Table 56. San Antonio to Brownsville via Laredo Demographics.**

| <b>Data Element</b>                                       | <b>San Antonio to Brownsville</b> |
|---|-----------------------------------|
| Population  |                                   |
| 2000  | 2,863,107                         |
| 2040  | 5,282,527                         |
| Population per Mile*                                      |                                   |
| 2000  | 8,203                             |
| 2040  | 15,136                            |
| Population - Over 65                                      |                                   |
| 2000  | 296,645                           |
| 2040  | 858,473                           |
| Employment  |                                   |
| No. of Employees (2005)                                   | 975,101                           |
| No. of Employer Establishments (2005)                     | 59,605                            |
| Total Public or Private University Enrollment (Fall 2006) | 73,451                            |

\*Calculation using corridor length = 349 miles

*Corridor Travel Patterns: Intercity Passenger Rail*

No existing passenger rail service is available on this corridor. Commuter rail is being planned for the lower Rio Grande Valley.

*Corridor Travel Patterns: Commercial Air Carrier Service*

The existing commercial airports within the San Antonio to Brownsville via Laredo Corridor include San Antonio International Airport (SAT), Laredo International Airport (LRD), McAllen/Miller International Airport (MFE), Harlingen-Valley Airport (HRL), and Brownsville/South Padre Island Airport (BRO). The air service market distance between SAT and BRO is 233 miles, and between BRO and Dallas/DFW is 482 miles. In 2006, the total number of air trips between San Antonio and Brownsville via Laredo was 77,410, which is a 3.24 percent decrease compared to 1996 figures. Between 1996 and 2008, specific indices for the air travel demand for the San Antonio to Brownsville via Laredo Corridor are shown in [Table 57](#).

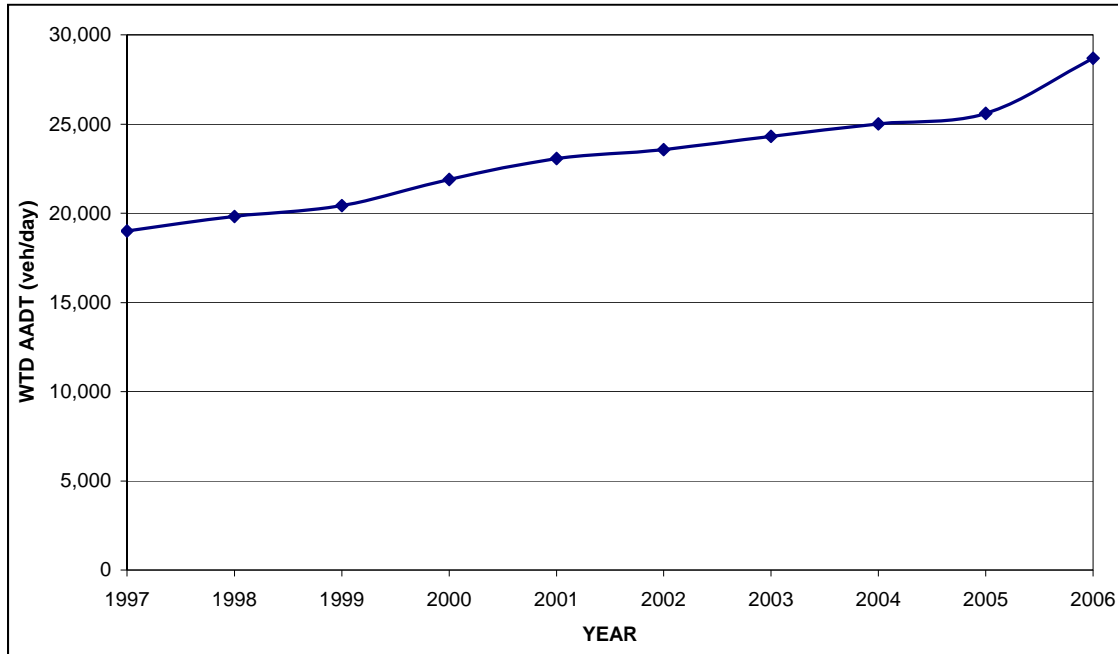
**Table 57. Air Travel Demand for Corridor San Antonio to Brownsville from 1996 to 2008.**

| <i>Year</i>                          | <i>Number of Flights</i> | <i>Number of Passengers</i> | <i>Number of Seats</i> | <i>Load Factor</i> |
|--------------------------------------|--------------------------|-----------------------------|------------------------|--------------------|
| 1996                                 | 1,453                    | 125,663                     | 186,552                | 0.67               |
| 2008                                 | 1,331                    | 107,729                     | 175,228                | 0.61               |
| 1996–2008<br>(Annual percent change) | –0.65%                   | –1.10%                      | –0.47%                 | –0.67%             |

In 2006, the average number of scheduled flights per day on the corridor between San Antonio and Brownsville is three flights per day.

*Corridor Travel Patterns: Highway*

Figure 78 shows the 10-year growth in the AADT for the entire corridor. The annual growth between 1997 and 2000 was 5.10 percent, as shown in Table 58. In 2006 the overall corridor AADT was 28,689 vehicles per day, with the expected 2035 value to reach over 60,500 vehicles per day.



**Figure 78. San Antonio to Brownsville via Laredo 10-Year Weighted AADT, 1997–2006.**

Table 58 shows the highway travel statistics. The overall volume-to-capacity ratio along the roadway corridors in 2002 was 0.44, with a 1.0 representing a roadway at capacity. The 2035 projected V/C ratio worsens to an expected value of 1.05. As the corridor exceeds the available capacity, the average speed for the corridor is expected to decrease from 53 mph in 2002 to 37 mph in 2035. Finally, trucks are expected to become a larger portion of the traffic stream, increasing from 14.28 percent in 2002 to 15.45 percent by 2035.

**Table 58. San Antonio to Brownsville via Laredo Highway Travel Patterns.**

| <b>Data Element</b>                                  | <b>San Antonio to Brownsville</b>                  |
|--|--|
| % Annual Growth in Average Corridor AADT (1997–2006) | 5.10%  |
| Average Corridor AADT<br>2006<br>2035                | 28,689 vehicles per day<br>60,529 vehicles per day |
| Average Volume-to-Capacity Ratio<br>2002<br>2035     | 0.44<br>1.05                                       |
| Average Speed<br>2002<br>2035                        | 53 mph<br>37 mph                                   |
| Average % Trucks<br>2002<br>2035                     | 14.28%<br>15.45%                                   |

**Existing Bus Transit, Intermodal Facilities, and Freight Rail**

The following sections summarize the existing transit and freight rail services and routes in the study corridor area.

*Existing Bus Service*

An Amtrak Thruway Connector bus runs once daily connecting Laredo and San Antonio and one time daily from Brownsville to San Antonio via Harlingen and McAllen.

*Intermodal Facilities*

Intermodal facilities include passenger train stations, bus stops/stations, transit centers and other facilities that could potentially become intermodal facilities if market demands and development allows. On the San Antonio to Brownsville via Laredo Corridor, specific facilities are as follows:

- |                                   |                                   |
|-----------------------------------|-----------------------------------|
| Kerrville intermodal facility     | Rio Grande City Greyhound station |
| Del Rio Multimodal Transit Center | Laredo Greyhound station          |
| Harlingen Greyhound station       | San Antonio Amtrak station        |
| McKinney Greyhound station        | San Antonio Greyhound station     |

The San Antonio West Side Multimodal Center has been proposed to be another intermodal center in this corridor.



*Transit Agencies*

The San Antonio to Brownsville via Laredo Corridor goes through four planning regions in Texas. There are in total 12 existing transit agencies along the corridor, namely:

|  |                             |
|--|-----------------------------|
| Alamo Area Regional Transit                      | McAllen Express             |
| Brownsville Urban Transit                        | Rainbow Lines               |
| Capital Area Rural Transportation System (CARTS) | Rio Metro                   |
| El Metro Transit                                 | Rio Transit                 |
| El Aguila Rural Transportation                   | The Wave-South Padre Island |
| Harlingen Express                                | VIA Metropolitan Transit    |

*Existing Freight Rail Operations*

There is one existing Union Pacific-owned freight rail line parallel to I-35 within the corridor between San Antonio and Laredo. No rail service exists between Laredo and the Rio Grande Valley area, where service is provided by shortline rail companies. [Table 59](#) represents the current train volumes provided by the Class I railroads and as determined through various freight rail mobility studies conducted by TxDOT. Future train volumes per rail line segment are based on a 3 percent annualized growth rate.

**Table 59. Segment Density and Rail Volumes (San Antonio to Brownsville).**

| Segment               | Current Volume (trains per day) | Future Volume* (trains per day) | Growth (trains per day) | Percent Growth | Segment Density (MGTM/Mi) |
|-----------------------|---------------------------------|---------------------------------|-------------------------|----------------|---------------------------|
| San Antonio to Laredo | 15-25                           | 40-60                           | 25-35                   | 140-170        | 30-35                     |
| Laredo to Brownsville | No freight rail service         |                                 |                         |                |                           |

\*by year of 2035

[Table 60](#) represents the current (2007) and future (2035) levels-of-service as indicated by the *National Rail Freight Infrastructure Capacity and Investment Study (2007)*.

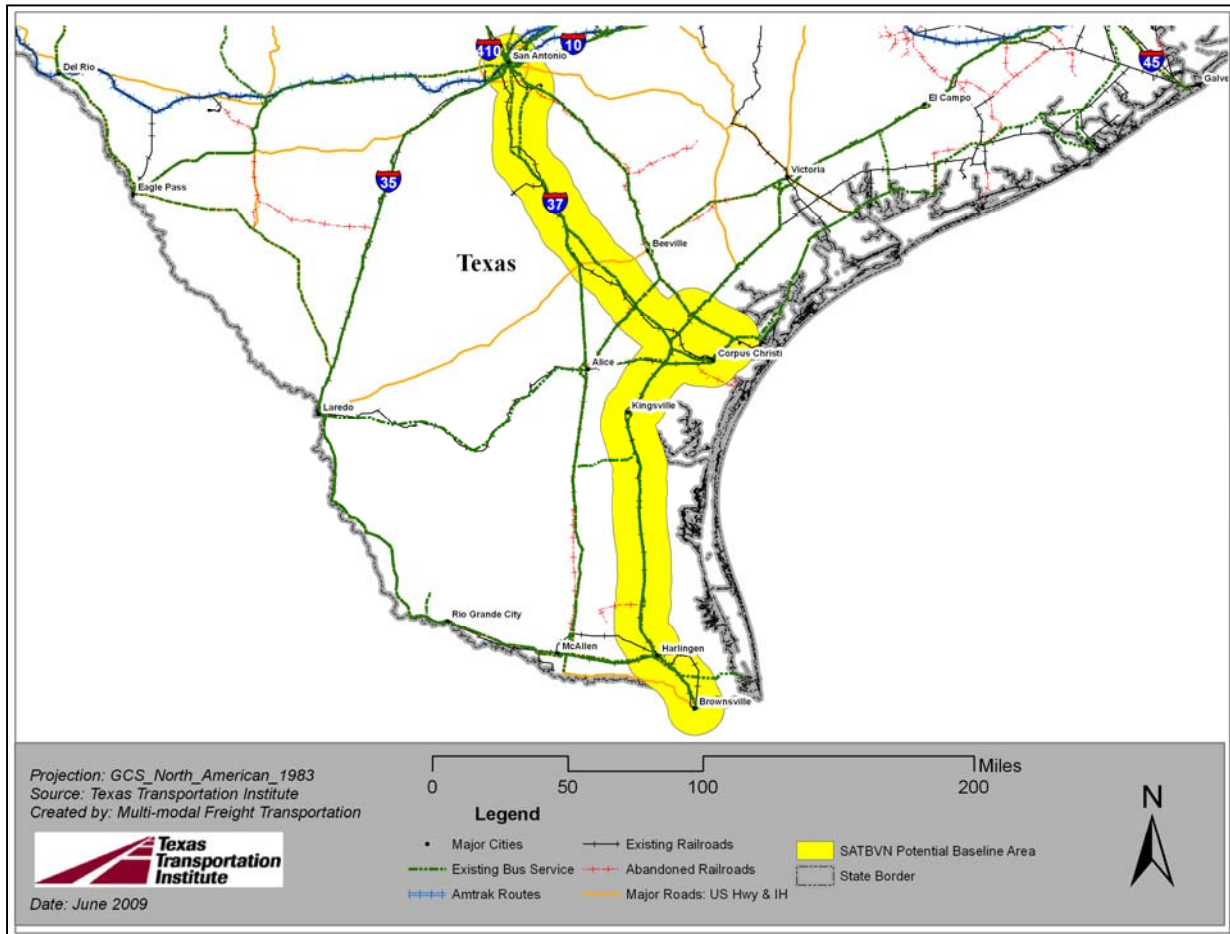
**Table 60. Current and Future Levels-of-Service (San Antonio to Brownsville).**

| Segment               | Current LOS             | Future LOS - Unimproved | Future LOS - Improved |
|-----------------------|-------------------------|-------------------------|-----------------------|
| San Antonio to Laredo | A, B, C                 | F                       | A, B, C               |
| Laredo to Brownsville | No freight rail service |                         |                       |

# SAN ANTONIO TO BROWNSVILLE VIA CORPUS CHRISTI

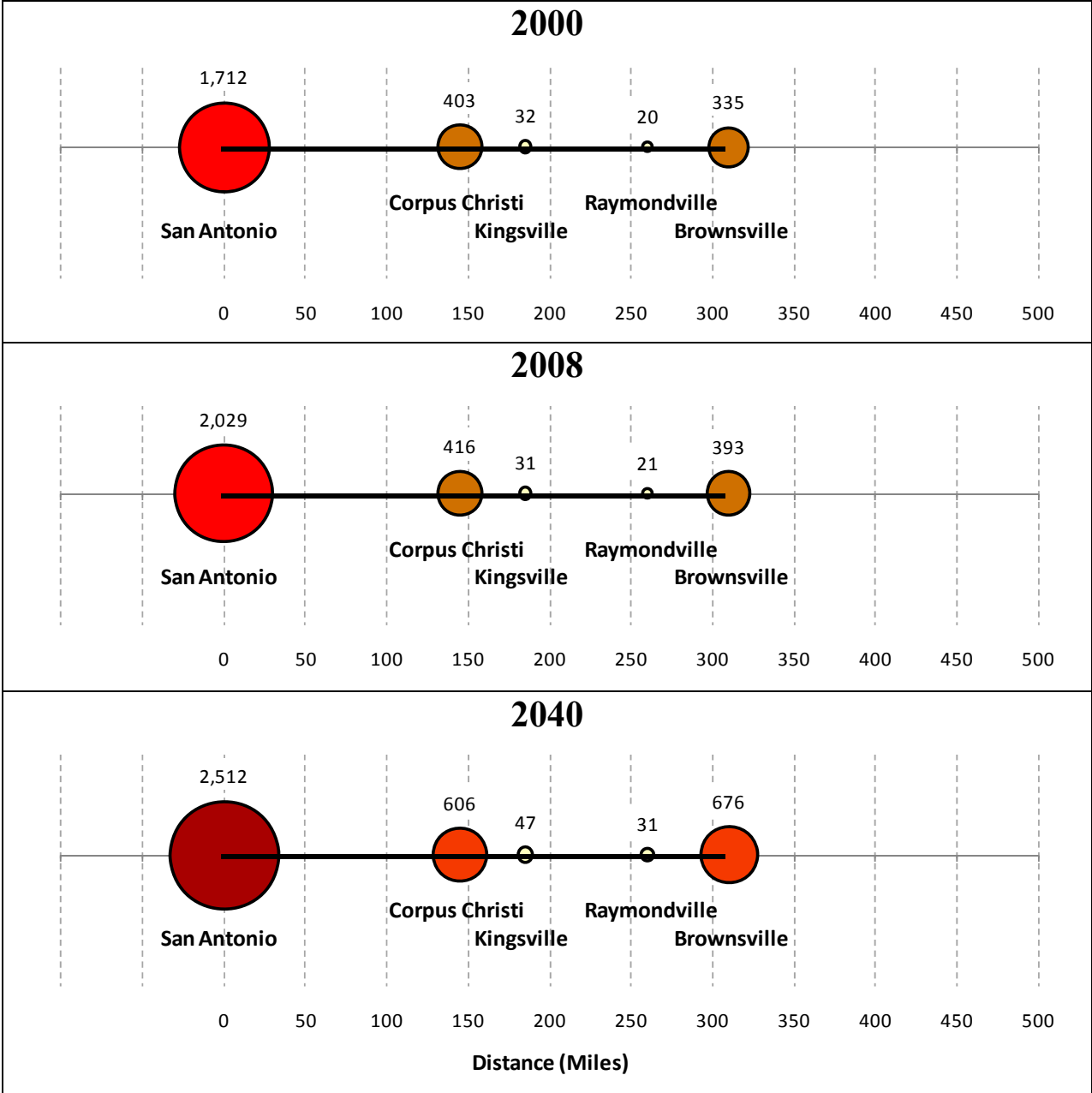
## Corridor Overview

From San Antonio, there are several routes in which to travel to Brownsville. Another route investigated as part of research Project 0-5930 travels south from San Antonio along I-37 to Corpus Christi and US 77 south through Harlingen and Brownsville. This route captures the port city of Corpus Christi but does not directly capture the growing areas of McAllen and Edinburg to the west of Brownsville. Figure 79 shows the San Antonio to Brownsville via Corpus Christi Corridor examined in Project 0-5930.



**Figure 79. San Antonio to Brownsville via Corpus Christi.**

Including the San Antonio CBSA, this corridor captures the Corpus Christi metropolitan CBSA, Kingsville micropolitan CBSA, Raymondville micropolitan CBSA, and Brownsville-Harlingen metropolitan CBSA. Figure 80 shows the CBSA populations along the San Antonio to Brownsville via Corpus Christi Corridor, along with a view of the relative distance between these urban centers.



**Figure 80. San Antonio to Brownsville via Corpus Christi (Population in Thousands).**

The corridor is approximately 300 miles in length, with the segment between San Antonio and Corpus Christi making up 145 miles. The separations between the other areas are 40, 75, and 50 miles, as shown in [Table 61](#).

Both [Figure 80](#) and [Table 61](#) provide the 2000, 2008, and 2040 populations of the corridor CBSAs, along with the distances between the urban areas. The San Antonio CBSA is expected to grow from 1.7 million people in 2000 to 2.5 million people by 2040. The Brownsville-Harlingen CBSA is expected to almost double, from 335,200 in 2000 to over 675,000 by 2040.

**Table 61. San Antonio to Brownsville via Corpus Christi CBSA Population, Distances, and Estimated Travel Times.**

| CBSA           | Population |           |           | Distance |            | Travel Time (hours:minutes) |        |         |         |         |
|----------------|------------|-----------|-----------|----------|------------|-----------------------------|--------|---------|---------|---------|
|                | 2000       | 2008      | 2040      | Segment  | Cumulative | 60 mph                      | 80 mph | 110 mph | 150 mph | 200 mph |
| San Antonio    | 1,711,700  | 2,028,832 | 2,512,000 | 0        | 0          | 0:00                        | 0:00   | 0:00    | 0:00    | 0:00    |
| Corpus Christi | 403,300    | 415,882   | 606,100   | 145      | 145        | 2:25                        | 1:48   | 1:19    | 0:58    | 0:43    |
| Kingsville     | 32,000     | 30,978    | 47,400    | 40       | 185        | 3:05                        | 2:18   | 1:40    | 1:14    | 0:55    |
| Raymondville   | 20,100     | 20,975    | 30,500    | 75       | 260        | 4:20                        | 3:15   | 2:21    | 1:44    | 1:18    |
| Brownsville    | 335,200    | 393,355   | 675,700   | 50       | 310        | 5:10                        | 3:52   | 2:49    | 2:04    | 1:33    |

**Market Potential**

This section demonstrates several demographic and roadway travel statistics for the San Antonio to Brownsville via Corpus Christi Corridor. Projected population numbers are presented by the Texas State Demographer, while the roadway information comes from the TxDOT Road–Highway Inventory Network (RHiNo) database and FHWA Freight Analysis Framework database.

*Population, Economic Activity, and Special Generators*

The combined population of the five CBSAs was over 2.5 million in 2000 and is expected to grow to over 3.8 million by 2040 as shown in [Table 62](#). Using a corridor length of 280 miles, the population per mile in 2000 was 8,936 people. That value is expected to grow to an average over 13,000 per mile by 2040. Additionally, the portion of the population over 65 years of age is expected to grow from 274,508 in 2000 to 703,433 people by 2040. The portion of persons older than 65 years of age will increase from 10.9 percent in 2000 to 18.1 percent by 2040. Along the corridor there were an estimated 55,162 establishments that employed over 904,126 people in 2005.

**Table 62. San Antonio to Brownsville via Corpus Christi Demographics.**

| Data Element  | San Antonio to Brownsville |
|---|----------------------------|
| Population  |                            |
| 2000  | 2,502,255                  |
| 2040  | 3,871,808                  |
| Population per Mile*                                      |                            |
| 2000  | 8,936                      |
| 2040  | 13,827                     |
| Population - Over 65                                      |                            |
| 2000  | 274,508                    |
| 2040  | 703,433                    |
| Employment  |                            |
| No. of Employees (2005)                                   | 904,126                    |
| No. of Employer Establishments (2005)                     | 55,162                     |
| Total Public or Private University Enrollment (Fall 2006) | 65,965                     |

\*Calculation using corridor length = 280 miles

*Corridor Travel Patterns: Intercity Passenger Rail*

No existing passenger rail service is available on this corridor. Commuter rail is being studied in the Lower Rio Grande Valley area to connect the large population centers.

*Corridor Travel Patterns: Commercial Air Carrier Service*

Existing commercial airports within the San Antonio to Brownsville via Corpus Christi Corridor include San Antonio International Airport (SAT), Corpus Christi Airport (CRP), Harlingen-Valley Airport (HRL), and Brownsville/South Padre Island Airport (BRO). Air service market distance between San Antonio and BRO is 233 miles, between Brownsville and Dallas/DFW is 482 miles, and between Corpus Christi and Dallas/DFW is 354 miles. In 2006, the total number of air trips between San Antonio and Brownsville via Corpus Christi is 74,620, a 2.61 percent decrease compared to 1996. [Table 63](#) shows specific indices for air travel demand for the corridor between San Antonio and Brownsville via Corpus Christi between 1996 and 2008.

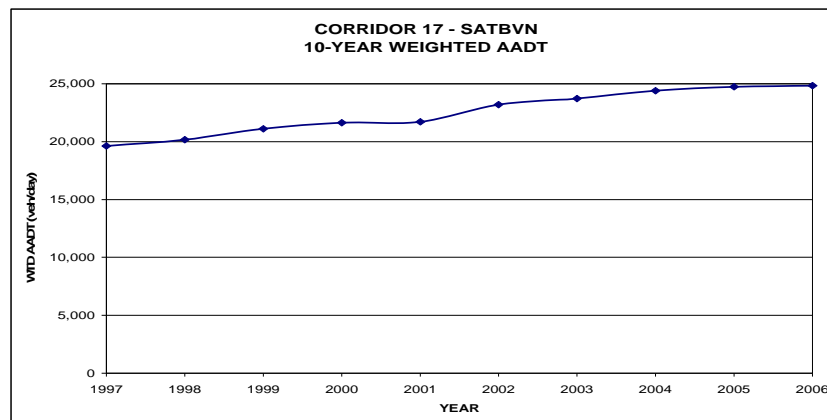
**Table 63. Air Travel Demand for Corridor from 1996 to 2008.**

| Year                                 | Number of Flights | Number of Passengers | Number of Seats | Load Factor |
|--------------------------------------|-------------------|----------------------|-----------------|-------------|
| 1996                                 | 1,825             | 131,327              | 210,115         | 0.67        |
| 2008                                 | 1,331             | 107,729              | 175,228         | 0.61        |
| 1996–2008<br>(Annual percent change) | -2.08%            | -1.38%               | -1.28%          | -0.13%      |

In 2006, the average number of scheduled flights per day on the corridor between San Antonio and Brownsville via Laredo is three flights per day.

*Corridor Travel Patterns: Highway*

[Figure 81](#) shows the 10-year growth in the AADT for the entire corridor. The annual growth between 1997 and 2000 was 2.65 percent, as shown in [Table 64](#). In 2006 the overall corridor AADT was 24,829 vehicles per day, with the expected 2035 value to reach over 49,173 vehicles per day.



**Figure 81. San Antonio to Brownsville via Corpus Christi 10-Year Weighted AADT, 1997–2006.**

Table 64 shows the highway travel statistics for this corridor route. The overall volume-to-capacity ratio in 2002 was 0.46, with a 1.0 representing a roadway at capacity. The 2035 projected V/C ratio weighted over the corridor worsens to an expected value of 1.00. As the corridor approaches the available capacity, the average speed for the corridor is expected to decrease from 58 mph in 2002 to 45 mph in 2035. Finally, trucks are expected to remain slightly under 14 percent of the traffic mix.

**Table 64. San Antonio to Brownsville via Corpus Christi Highway Travel Patterns.**

| <b>Data Element</b>                                  | <b>San Antonio to Brownsville</b> |
|--|-----------------------------------|
| % Annual Growth in Average Corridor AADT (1997–2006) | 2.65%                             |
| Average Corridor AADT                                |                                   |
| 2006   | 24,829 vehicles per day           |
| 2035   | 49,173 vehicles per day           |
| Average Volume-to-Capacity Ratio                     |                                   |
| 2002   | 0.46                              |
| 2035   | 1.00                              |
| Average Speed  |                                   |
| 2002   | 58 mph                            |
| 2035   | 45 mph                            |
| Average % Trucks                                     |                                   |
| 2002   | 13.6%                             |
| 2035   | 13.9%                             |

### **Passenger Rail, Bus Transit, Air Services, and Freight Rail**

The following sections summarize the existing transit and freight rail services and routes in the study corridor area.

#### *Existing Bus Service*

An Amtrak Thruway Connector bus runs one time daily from Brownsville to San Antonio via Harlingen and McAllen. Valley Transit Company, a Greyhound subsidiary in the United States that serves the Texas-Mexico border area, provides bus service to San Antonio in this corridor two times daily and one time daily via Alice and McAllen.

#### *Intermodal Facilities*

Intermodal facilities include passenger train stations, bus stops/stations, transit centers, and other facilities that could potentially become intermodal facilities if market demands and development allows. On the San Antonio to Brownsville via Corpus Christi Corridor, specific facilities are as follows:

- |                                  |                              |
|----------------------------------|------------------------------|
| Brownsville Greyhound station    | Kingsville Greyhound station |
| Corpus Christi Greyhound station | San Antonio Amtrak station   |

Harlingen Greyhound station  
 Kerrville intermodal facility

San Antonio Greyhound station

The San Antonio West Side Multimodal Center has been proposed to be another intermodal center in this corridor.

*Transit Agencies*

The San Antonio to Brownsville via Corpus Christi Corridor goes through three planning regions in Texas. There are in total 15 existing transit agencies along the corridor, namely:

|  |   |
|--|---|
| Alamo Area Regional Transit                          | McAllen Express   |
| Bee Community Action Agency<br>(BCAA)                | Rainbow Lines<br>Rio Metro  |
| Brownsville Urban Transit                            | Rio Transit   |
| Capital Area Rural Transportation<br>System (CARTS)  | Rural Economic Assistance League (REAL)<br>The B (Corpus Christi) |
| Corpus Christi Regional Transit<br>Authority (CCRTA) | The Wave-South Padre Island<br>VIA Metropolitan Transit           |
| Harlingen Express                                    |   |
| Kleberg County Human Services<br>(KCHS)              |   |

*Existing Freight Rail Operations*

There are two existing Union Pacific-owned freight rail lines within the corridor: San Antonio to Corpus Christi and Corpus Christi to Brownsville. The former rail line runs parallel to I-37 and the latter parallel to US 77. [Table 65](#) represents the current and future train volumes per rail line segment according to the *National Rail Freight Infrastructure Capacity and Investment Study* (2007) along with the estimated rail line density, noted from the *2007 National Transportation Atlas Database (NTAD)*.

**Table 65. Segment Density and Rail Volumes.**

| Segment                          | Current Volume<br>(trains per day) | Future<br>Volume*<br>(trains per<br>day) | Growth<br>(trains per<br>day) | Percent<br>Growth | Segment<br>Density<br>(MGTM/Mi) |
|----------------------------------|------------------------------------|--|-------------------------------|-------------------|---------------------------------|
| San Antonio to<br>Corpus Christi | 5-10                               | 20-30                                    | 15-20                         | 200-300           | 10-15                           |
| Corpus Christi<br>to Brownsville | 4-8                                | 8-16                                     | 4-8                           | 100-200           | 5-10                            |

\*by year of 2035

Table 66 represents the current (2007) and future (2035) levels-of-service as indicated by the *National Rail Freight Infrastructure Capacity and Investment Study (2007)*.

**Table 66. Current and Future Levels-of-Service (San Antonio to Brownsville).**

| Segment                       | Current LOS               | Future LOS - Unimproved | Future LOS - Improved |
|-------------------------------|---------------------------|-------------------------|-----------------------|
| San Antonio to Corpus Christi | Not included in AAR study |                         |                       |
| Corpus Christi to Brownsville | D                         | F                       | A, B, C               |

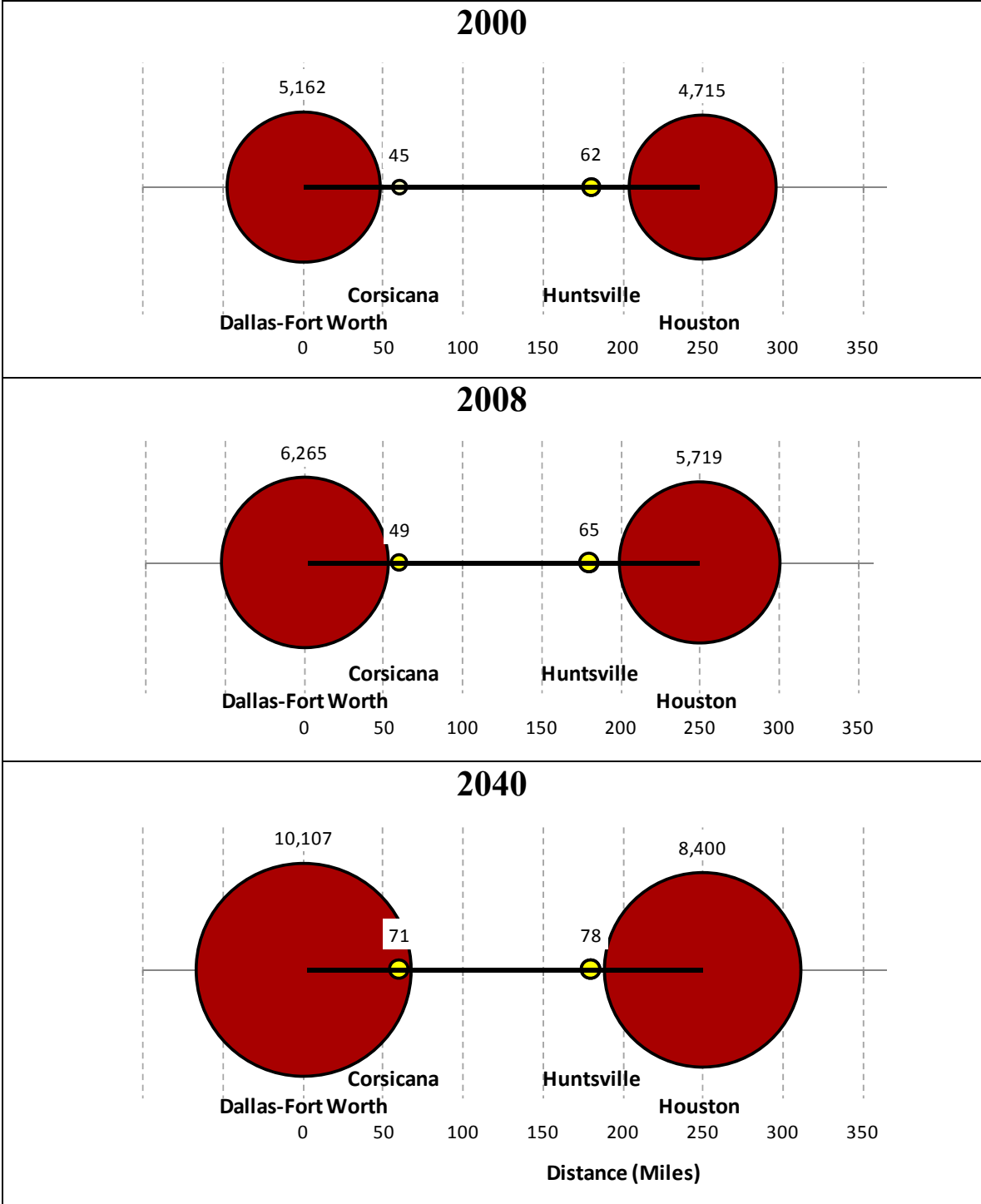
## DALLAS-FORT WORTH TO HOUSTON CORRIDOR OVERVIEW

This section includes a compilation of data and statistics developed during TxDOT Project 0-5930 for the Dallas-Fort Worth to Houston Corridor. The corridor selected for study generally followed the route of I-45, which directly connects the two major urban areas. As discussed in the previous section, however, additional route options that might incorporate additional urban areas along the route and the associated ridership must also be considered. The following paragraphs discuss the direct I-45-based corridor. Following this discussion, the additional option of another optional route from Houston via College Station and Waco to Dallas-Fort Worth is discussed.

Figure 82 provides a view of the CBSA populations along the Dallas-Fort Worth to Houston I-45 Corridor, along with a showing the relative distance between the urban centers. The corridor is approximately 250 miles in length with a total of four CBSAs: two classified as metropolitan and two as micropolitan. According to the 2000 Federal Census, over 5.1 million people resided in the Dallas-Fort Worth-Arlington CBSA, while the population of the Houston-Sugar Land-Baytown CBSA exceeded 4.7 million people. The two micropolitan CBSAs along the route are Corsicana, with a 2000 population of approximately 45,000, and Huntsville, with a 2000 population of 61,800.

In addition to the 2000 population, Figure 82 contains the 2008 census estimates and the expected 2040 population for all four CBSAs in the corridor based on projections by the Texas State Demographer. The Dallas-Fort Worth-Arlington CBSA is expected to almost double to over 10 million people by 2040. The Houston-Sugar Land-Baytown CBSA is also expected to grow significantly, from 4.7 to 8.4 million in 2040. The Corsicana and Huntsville CBSA are expected to reach 70,900 and 77,800, respectively, in 2040.





**Figure 82. Dallas-Fort Worth to Houston Corridor Population and Distance (Population in Thousands).**

Table 67 shows the distance between the urban areas along the corridor and estimated travel time between urban areas for a variety of average rail operational speeds along the corridor based on a direct alignment paralleling I-45.

**Table 67. Dallas-Fort Worth to Houston CBSA Population, Distances, and Estimated Travel Times.**

| CBSA       | Population |           |            | Distance |            | Travel Time (hours:minutes) |        |         |         |         |
|------------|------------|-----------|------------|----------|------------|-----------------------------|--------|---------|---------|---------|
|            | 2000       | 2008      | 2040       | Segment  | Cumulative | 60 mph                      | 80 mph | 110 mph | 150 mph | 200 mph |
| DFW        | 5,161,500  | 6,265,000 | 10,106,800 | 0        | 0          | 0:00                        | 0:00   | 0:00    | 0:00    | 0:00    |
| Corsicana  | 45,100     | 49,300    | 70,900     | 60       | 60         | 1:00                        | 0:45   | 0:32    | 0:24    | 0:18    |
| Huntsville | 61,800     | 64,600    | 77,800     | 120      | 180        | 3:00                        | 2:15   | 1:38    | 1:12    | 0:54    |
| Houston    | 4,715,400  | 5,718,700 | 8,400,100  | 70       | 250        | 4:10                        | 3:07   | 2:16    | 1:40    | 1:15    |

**Market Potential**

This section exhibits several demographic and roadway travel statistics for the DFW to Houston Corridor. Projected population numbers are presented by the Texas State Demographer, while the roadway information comes from the TxDOT TxDOT’s Road–Highway Inventory Network (RHiNo) database and FHWA Freight Analysis Framework database.

*Population, Economic Activity, and Special Generators:*

The Dallas-Fort Worth to Houston Corridor had a total population in the corridor CBSAs of 9.9 million in 2000. The population level is expected to reach over 18.6 million people by 2040 as shown in [Table 68](#). The average population per mile is expected to greatly increase from 39,618 in 2000 to 74,030 by 2040. Considerable growth is also expected in the segment of the population 65 years of age and older. [Table 68](#) shows that in 2000 the percentage of the total corridor population over 65 years of age was 7.8 percent, while in 2040 that percentage is expected to increase to 17.8 percent of the total corridor population.

The corridor maintained in 2005 approximately 251,000 employer establishments that employed over 4.5 million persons in 2005. Finally, the total higher education enrollment in 2006 was over 233,000 students, as shown in [Table 68](#).

**Table 68. Dallas-Fort Worth to Houston Demographics.**

| Data Element  | DFW to Houston |
|---|----------------|
| Population  |                |
| 2000  | 9,983,833      |
| 2040  | 18,655,657     |
| Population per Mile*                                      |                |
| 2000  | 39,618         |
| 2040  | 74,030         |
| Population - Over 65                                      |                |
| 2000  | 785,672        |
| 2040  | 3,321,769      |
| Employment  |                |
| No. of Employees (2005)                                   | 4,503,956      |
| No. of Employer Establishments (2005)                     | 251,274        |
| Total Public or Private University Enrollment (Fall 2006) | 233,169        |

\*Calculation using corridor length = 252 miles

*Corridor Travel Patterns: Commercial Air Carrier Service*

The existing commercial airports within the Dallas/Fort Worth to Houston Corridor include Dallas/Fort Worth International (DFW), Dallas Love Field (DAL), Easterwood Airport (CLL) in College Station, Houston’s William P. Hobby Airport (HOU), and Houston George Bush Intercontinental Airport (IAH). [Table 69](#) represents the market distance between airport pairs within the corridor.

**Table 69. Intrastate Passenger Air Service City-Pair Market Distance.**

| <b>Airport A</b> | <b>Airport B</b> | <b>Market Distance<br/>(Statute Miles)</b> |
|------------------|------------------|--|
| DFW              | HOU              | 247  |
| DFW              | IAH              | 224  |
| DAL              | HOU              | 239  |
| DAL              | IAH              | 217  |
| DFW              | CLL              | 164  |
| IAH              | CLL              | 74   |

In 2006, the total number of air trips between Dallas/Fort Worth airports and Houston airports was 1,643,640, which is a 2.45 percent decrease when compared to 1996. Between 1996 and 2008, specific indices for the air travel demand for Corridor Dallas/Fort Worth to Houston are shown in [Table 70](#).

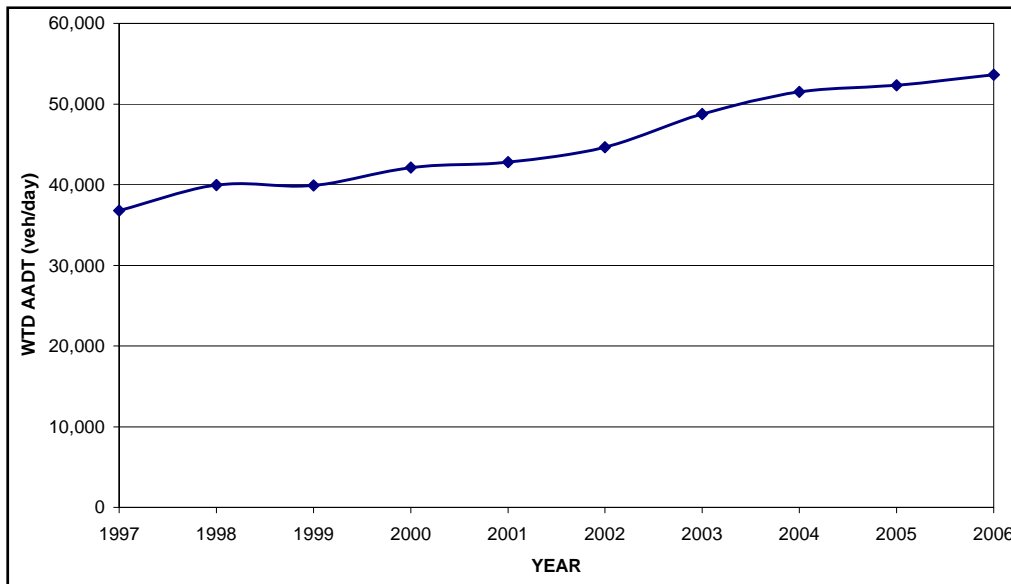
**Table 70. Air Travel Demand for Corridor Dallas/Fort Worth to Houston from 1996 to 2008.**

| <b>Year</b>                          | <b>Number of<br/>Flights</b> | <b>Number of<br/>Passengers</b> | <b>Number of<br/>Seats</b> | <b>Load Factor</b> |
|--------------------------------------|------------------------------|---------------------------------|----------------------------|--------------------|
| 1996                                 | 68,265                       | 4,328,035                       | 6,822,809                  | 0.63               |
| 2008                                 | 43,007                       | 3,021,462                       | 4,295,927                  | 0.70               |
| 1996–2008<br>(Annual percent change) | –2.85%                       | –2.32%                          | –2.85%                     | 0.84               |

In 2006, the average number of scheduled flights on the corridor between Dallas/Fort Worth and Houston is 130 flights per day. In Texas, nearly 71 million passengers were enplaned in 2007 and the number is expected to grow more than 104 million per year by 2025 according to FAA projections. Houston George Bush Intercontinental (IAH), Houston’s William P. Hobby (HOU), Dallas/Fort Worth International (DFW), and Dallas Love Field (DAL) are the four busiest airports in Texas and accounted for 81 percent of the total enplanements in the state in 2007.

*Corridor Travel Patterns: Highway*

The most direct highway route between the Houston area and Dallas-Fort Worth is along I-45. This corridor experienced a weighted corridor-average AADT increase of 4.57 percent each year between 1997 and 2006, with the 2006 AADT being 53,634 vehicles per day. [Figure 83](#) shows the 10-year weighted AADT trend. The projected average AADT levels are expected to reach over 106,000 vehicles per day over the corridor, as shown in [Table 71](#).



**Figure 83. Dallas-Fort Worth to Houston 10-Year Weighted AADT, 1997–2006.**

The overall I-45 corridor volume-to-capacity ratio in 2002 was 0.60, with a 1.0 representing a roadway at capacity. The 2035 projected V/C ratio worsens to an expected value of 1.28. This is shown in the 2002 and 2035 estimated average speed over the corridor dropping from 59 mph in 2002 to 39 mph in 2035. Finally, the number of trucks will increase along with the traffic growth in the corridor; however, the percentage of trucks along the corridor is expected to remain approximately the same at 19–20 percent in 2035. Table 71 shows the highway travel statistics.

**Table 71. Dallas-Fort Worth to Houston Highway Travel Patterns.**

| Data Element   | DFW to Houston           |
|--|--------------------------|
| % Annual Growth in Average Corridor AADT (1997–2006) | 4.57%                    |
| Average Corridor AADT                                |                          |
| 2006   | 53,634 vehicles per day  |
| 2035   | 106,475 vehicles per day |
| Average Volume-to-Capacity Ratio                     |                          |
| 2002   | 0.60                     |
| 2035   | 1.28                     |
| Average Speed  |                          |
| 2002   | 59 mph                   |
| 2035   | 39 mph                   |
| Average % Trucks                                     |                          |
| 2002   | 19.29%                   |
| 2035   | 20.12%                   |

## **Environmental Quality**

### *Currently Designated Nonattainment Areas in Texas for All Criteria Pollutants*

As of January 6, 2010, the nine counties in the Dallas/Fort Worth area (Collin, Dallas, Denton, Ellis, Johnson, Kaufman, Parker, Rockwall, and Tarrant) are designated as moderate nonattainment for 8-Hr Ozone by the EPA. In addition the eight counties in the Houston area (Brazoria, Chambers, Fort Bend, Galveston, Harris, Liberty, Montgomery, and Waller) are designated as severe nonattainment for 8-Hr Ozone by the EPA. [Figure 66](#) contains a map of these counties.

## **Passenger Rail, Bus Transit, Intermodal Services, and Freight Rail**

The following sections summarize the existing transit and freight rail services and routes in the study corridor area. These are for the I-45 corridor only. (A description of the adjacent corridor via College Station and Waco appears in a later section.)

### *Existing Intercity Passenger Rail Service*

No direct existing passenger rail service is available on the DFW-Houston Corridor despite the heavy travel between the two cities. Amtrak service between the two regions was discontinued in the mid-1990s.

### *Existing Bus Service*

Greyhound provides intercity bus service eight times daily between Dallas and Houston, five times daily from Fort Worth to Houston, and six times daily from Houston to Fort Worth.

### *Intermodal Facilities*

Intermodal facilities include passenger train stations, bus stops/stations, transit centers, and other facilities that could potentially become intermodal facilities if market demands and development allows. On the Dallas/Fort Worth to Houston Corridor, specific facilities are as follows:

|   |                             |
|---|-----------------------------|
| Dallas Union Station                        | Corsicana Greyhound station |
| Fort Worth Intermodal Transportation Center | Houston Amtrak station      |
|   | Houston Greyhound stations  |
| Cleburne intermodal terminal                |                             |

## **Transit Agencies**

|                                  |                               |
|----------------------------------|-------------------------------|
| Dallas Area Rapid Transit (DART) | The District (Brazos Transit) |
| The T (Fort Worth)               | METRO (Harris County)         |
| Denton County Transportation     | METRORail                     |

Authority  
 Cletran (Cleburne)  
 Collin County Area Regional Transit

Connect Transportation (Texas City)  
 Fort Bend County Transit

*Existing Freight Rail Operations*

Several existing freight rail routes travel between Dallas-Fort Worth and Houston. None of the existing freight rail routes directly follow I-45 south of Corsicana into Houston. North of Corsicana a UP line goes to Dallas, while a BNSF line goes to Fort Worth. Table 72 provides the segment listings for four existing route options between Dallas-Fort Worth and Houston, along with the adjacent roadway and rail owner. The shortest path would be a combination of the UP line from Dallas to Corsicana, and then the BNSF line from Corsicana to Houston. One item to note is that the UP utilizes relatively parallel routes to maintain specific directional operations. So based on operations, UP may use one route for northbound traffic, while utilizing a different route for southbound traffic. This would need to be taken into account in studying potential addition of passenger rail along these lines.

**Table 72. Freight Rail Lines Associated with Study Corridors – General Segment Description.**

| Segment Detail                  | General Description of Rail Lines and Adjacent Roadways | Segment RR |
|---------------------------------|---|------------|
| <b>DFW to Houston, Option 1</b> |   |            |
| DFW to Waco                     | Parallels I-35  | UP         |
| Waco to Navasota                | Parallels TX 6  | UP         |
| Navasota to Houston             | Parallels US 290  | UP         |
| <b>DFW to Houston, Option 2</b> |   |            |
| DFW to Waco                     | Parallels US 287 until Corsicana                        | UP         |
| Waco to Hearne                  | Predominantly parallels TX 6                            | UP         |
| Hearne to Navasota              | Parallels TX 6  | UP         |
| Navasota to Houston             | Parallels US 290  | UP         |
| <b>DFW to Houston, Option 3</b> |   |            |
| DFW to Temple                   | Parallels I-35  | BNSF       |
| Temple to Sealy                 | Predominantly parallels TX 6                            | BNSF       |
| Sealy to Houston                | Parallels TX 36   | BNSF       |
| <b>DFW to Houston, Option 4</b> |   |            |
| DFW to Corsicana                | Parallels US 287  | BNSF       |
| Corsicana to Houston            | Parallels I-45  | BNSF       |

Based on information obtained from the Class I freight railroads, as well as freight rail mobility studies conducted by TxDOT, the existing rail line segments between Dallas-Fort Worth and Houston experience an average of approximately 45–50 MGTM/Mi of freight each year as shown in Table 73. Additionally, Table 73 provides current and expected train volumes on select rail segments, based on a projected annualized growth rate of 3 percent. Several secondary rail lines in Texas were not examined in this analysis and are not included in Table 73.

These levels, presented in [Table 73](#), indicate significant growth is expected on many of the existing freight rail line segments between Dallas-Fort Worth and Houston by 2035.

**Table 73. Freight Rail Lines Associated with Study Corridors – Segment Density and Volumes.**

| Segment Detail                  | Segment RR | Segment Density (MGTM/Mi) | Current Volume (trains per day) | Future Volume* (trains per day) | Growth (trains per day) | Percent Growth |
|---------------------------------|------------|---------------------------|---------------------------------|---------------------------------|-------------------------|----------------|
| <b>DFW to Houston, Option 1</b> |            |                           |                                 |                                 |                         |                |
| DFW to Waco                     | UP         | 60-70                     | 45-50                           | 110-120                         | 65-70                   | 140            |
| Waco to Navasota                | UP         | 30-55                     | 20-40                           | 50-95                           | 30-55                   | 130-150        |
| Navasota to Houston             | UP         | 30-35                     | 15-20                           | 40-50                           | 25-30                   | 100-200        |
| <b>DFW to Houston, Option 2</b> |            |                           |                                 |                                 |                         |                |
| DFW to Waco                     | UP         | 60-70                     | 45-50                           | 110-120                         | 65-70                   | 140            |
| Waco to Hearne                  | UP         | 30-55                     | 35-40                           | 85-95                           | 50-55                   | 130-150        |
| Hearne to Navasota              | UP         | 30-35                     | 20-25                           | 50-60                           | 30-35                   | 140-150        |
| Navasota to Houston             | UP         | 30-35                     | 15-20                           | 40-50                           | 25-30                   | 100-200        |
| <b>DFW to Houston, Option 3</b> |            |                           |                                 |                                 |                         |                |
| DFW to Temple                   | BNSF       | 50-70                     | 20-30                           | 40-75                           | 20-45                   | 100-150        |
| Temple to Sealy                 | BNSF       | 60-90                     | 30-35                           | 75-85                           | 45-50                   | 150            |
| Sealy to Houston                | BNSF       | 50-55                     | 30-35                           | 75-85                           | 45-50                   | 150            |
| <b>DFW to Houston, Option 4</b> |            |                           |                                 |                                 |                         |                |
| DFW to Corsicana                | BNSF       | 10-20                     | 5-10                            | 20-30                           | 15-20                   | 100-200        |
| Corsicana to Houston            | BNSF       | 15-20                     | 5-10                            | 20-30                           | 15-20                   | 100-200        |

\*by year of 2035, excluding passenger trains

Based on current and forecast train levels and available capacity, the *National Rail Freight Infrastructure Capacity and Investment Study* (2007) presented a level-of-service (LOS) estimate for these routes. It is estimated that several of these line segments will experience LOS 'D' (approaching theoretical capacity) or worse in 2035 unless significant infrastructure improvements are undertaken. [Table 74](#) shows the current and projected LOS for the possible routes as identified in the 2007 capacity and investment study.

**Table 74. Freight Rail Lines Associated with Study Corridors – Current and Future Levels-of-Service.**

| Segment Detail                  | Segment RR | Current LOS        | Future LOS - Unimproved | Future LOS - Improved |
|---------------------------------|------------|--------------------|-------------------------|-----------------------|
| <b>DFW to Houston, Option 1</b> |            |                    |                         |                       |
| DFW to Waco                     | UP         | A, B, C            | D                       | A, B, C               |
| Waco to Navasota                | UP         | A, B, C            | F                       | A, B, C               |
| Navasota to Houston             | UP         | A, B, C            | A, B, C                 | A, B, C               |
| <b>DFW to Houston, Option 2</b> |            |                    |                         |                       |
| DFW to Waco                     | UP         | A, B, C            | E                       | A, B, C               |
| Waco to Hearne                  | UP         | A, B, C            | A, B, C                 | A, B, C               |
| Hearne to Navasota              | UP         | A, B, C            | F                       | A, B, C               |
| Navasota to Houston             | UP         | A, B, C            | A, B, C                 | A, B, C               |
| <b>DFW to Houston, Option 3</b> |            |                    |                         |                       |
| DFW to Temple                   | BNSF       | A, B, C            | D                       | A, B, C               |
| Temple to Sealy                 | BNSF       | A, B, C            | F                       | A, B, C               |
| Sealy to Houston                | BNSF       | D                  | F                       | A, B, C               |
| <b>DFW to Houston, Option 4</b> |            |                    |                         |                       |
| DFW to Corsicana                | BNSF       | Not in 2007 study. | Not in 2007 study.      | Not in 2007 study.    |
| Corsicana to Houston            | BNSF       | Not in 2007 study. | Not in 2007 study.      | Not in 2007 study.    |

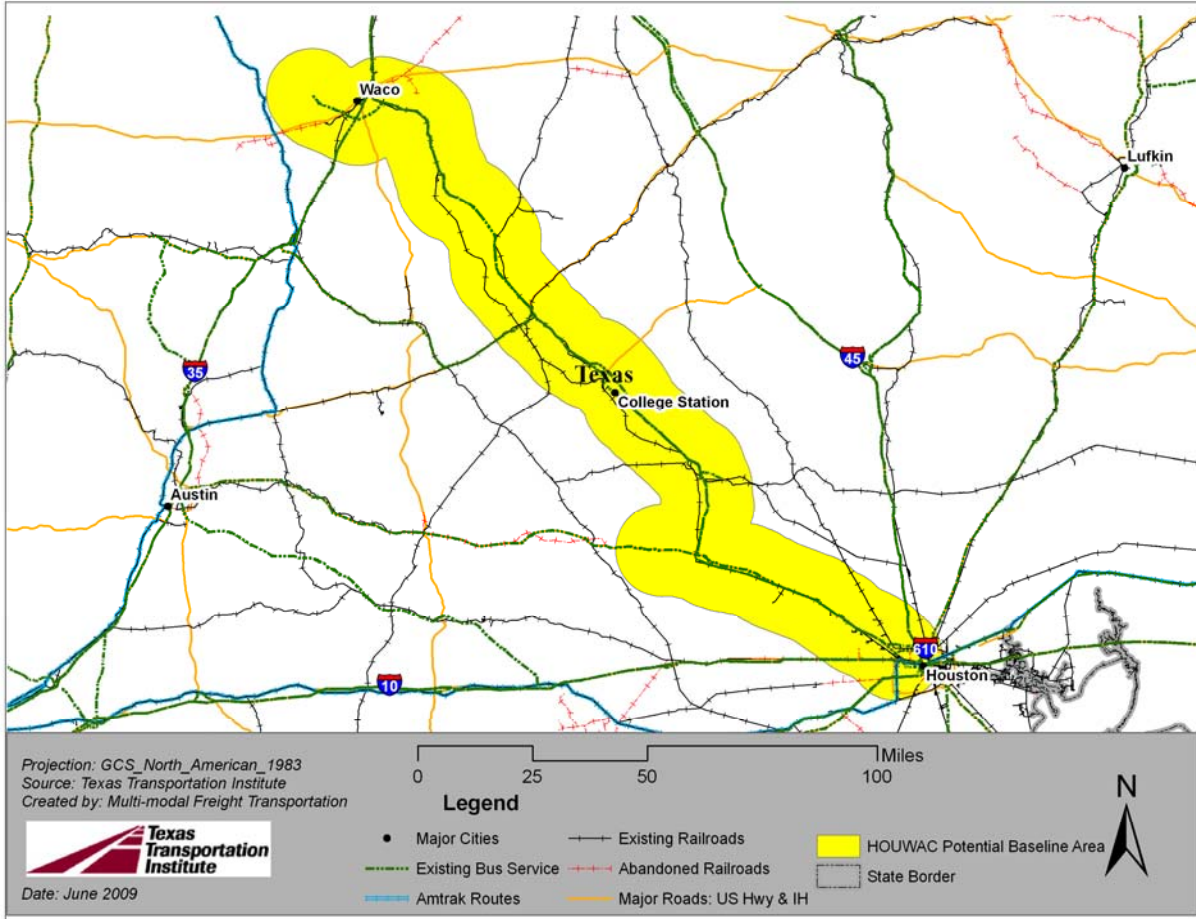
The following pages describe data from the adjacent Houston to Waco via College Station Corridor examined in Project 0-5930.

## **HOUSTON TO DALLAS VIA COLLEGE STATION/BRYAN AND WACO CORRIDOR OPTION**

### **Corridor Overview**

The Houston to Waco Corridor examined in Project 0-5930 traverses US 290 between Houston and Hempstead and then Texas Highway 6 (TX 6) from Hempstead to Waco, where it passes through the College Station-Bryan metropolitan CBSA as shown in [Figure 84](#). The Waco CBSA is also classified as a metropolitan CBSA. From Waco, the corridor could extend north along the I-35 corridor to reach Dallas-Fort Worth. The I-35 Corridor is the subject of another HSIPR application. Connecting to another existing corridor could potentially minimize the length of the overall Texas high-speed rail network and reduce construction and operational costs.

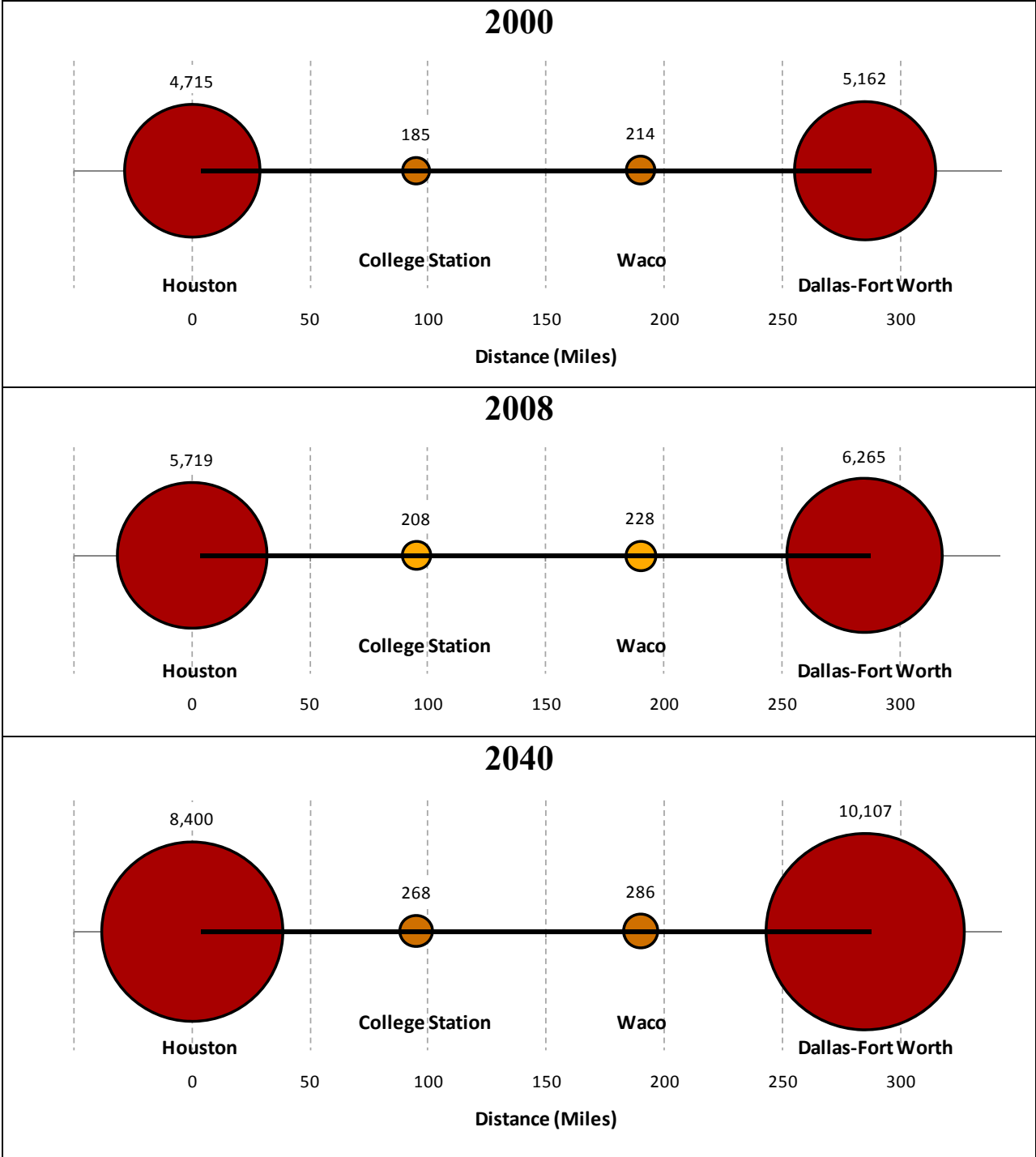




**Figure 84. Houston to Waco Corridor Map.**

Figure 85 provides a view of the CBSA populations along the Houston to College Station to Waco to Dallas Corridor, along with a demonstration of the distance between these urban centers. The corridor is approximately 285 miles in length, with the Houston-Sugar Land-Baytown CBSA providing the majority of the population for the corridor. However, the corridor stretches to the Waco CBSA, which is located on the heavily utilized I-35 corridor and north along it to Dallas-Fort Worth.

In 2000, the Houston-Sugar Land-Baytown CBSA population exceeded 4.7 million people. As is seen in Figure 85, that population level is expected to grow to 8.4 million people by 2040. The College Station-Bryan and Waco CBSAs are expected to grow from 185,000 to 268,000 and 214,000 to 286,000, respectively. While these smaller CBSAs growth rate is relatively slow compared with that of Houston or Dallas, they are much larger and, due to their historic educational and medical facilities, much more likely to generate further development potential than the intermediate urban areas along the I-45 corridor between Dallas-Fort Worth and Houston.



**Figure 85. Houston to Waco Corridor Population Distribution.**

Additionally, [Table 75](#) shows the distance between the urban areas along the corridor and estimated travel time along the entire corridor.

**Table 75. Houston to Waco to Dallas-Fort Worth CBSA Population, Distances, and Estimated Travel Times.**

| CBSA            | Population |           |            | Distance |            | Travel Time (hours:minutes) |        |         |         |         |
|-----------------|------------|-----------|------------|----------|------------|-----------------------------|--------|---------|---------|---------|
|                 | 2000       | 2008      | 2040       | Segment  | Cumulative | 60 mph                      | 80 mph | 110 mph | 150 mph | 200 mph |
| Houston         | 4,715,400  | 5,718,700 | 8,400,100  | 0        | 0          | 0:00                        | 0:00   | 0:00    | 0:00    | 0:00    |
| College Station | 184,900    | 208,400   | 267,700    | 95       | 95         | 1:35                        | 1:11   | 0:51    | 0:38    | 0:28    |
| Waco            | 213,500    | 228,500   | 285,500    | 95       | 190        | 3:10                        | 2:22   | 1:43    | 1:16    | 0:57    |
| DFW             | 5,161,500  | 6,265,000 | 10,106,800 | 95       | 285        | 4:45                        | 3:33   | 2:35    | 1:54    | 1:25    |

### Market Potential

This section demonstrates several demographic and roadway travel statistics for the Houston to Dallas-Fort Worth via College Station/Bryan and Waco Corridor. Projected population numbers are presented by the Texas State Demographer, while the roadway information comes from the TxDOT Road-Highway Inventory Network (RHINO) database and FHWA Freight Analysis Framework database.

#### *Population, Economic Activity, and Special Generators*

The Houston to Dallas-Fort Worth via College Station/Bryan and Waco Corridor maintained a total population in the corridor CBSAs of 5.1 million in 2000. The population level is expected to reach over 8.9 million people in 2040 as shown in [Table 76](#). The population per mile is expected to greatly increase from 36,053 people per mile in 2000 to 66,877 people per mile in 2040. Considerable growth is expected in the population 65 years of age and older, as seen in [Table 76](#). The corridor maintained in 2005 approximately 258,621 employer establishments that employed over 4.6 million persons in 2005. Finally, the total higher education enrollment in 2006 was 146,702 students for the Waco to Houston segment studied in Project 0-5930, as shown in [Table 76](#).

**Table 76. Houston to Dallas via College Station and Waco Demographics.**

| Data Element  | Houston to Waco |
|---|-----------------|
| Population  |                 |
| 2000  | 10,275,353      |
| 2040  | 19,060,210      |
| Population per Mile*                                      |                 |
| 2000  | 36,053          |
| 2040  | 66,877          |
| Population - Over 65                                      |                 |
| 2000  | 816,698         |
| 2040  | 3,385,731       |
| Employment  |                 |
| No. of Employees (2005)                                   | 4,625,297       |
| No. of Employer Establishments (2005)                     | 258,621         |
| Total Public or Private University Enrollment (Fall 2006) | 146,702**       |

\*Calculation using corridor length = 285 miles

\*\*Houston to Waco Corridor numbers only. Does not include DFW-Waco segment which was not part of Project 0-5930 study for this corridor.

*Corridor Travel Patterns: Commercial Air Carrier Service*

The existing commercial airports within the Houston to Dallas/Fort Worth via Waco Corridor include Dallas/Fort Worth International (DFW), Dallas Love Field (DAL), Easterwood Airport (CLL), Houston’s William P. Hobby Airport (HOU), and Houston George Bush Intercontinental Airport (IAH). [Table 77](#) represents the market distance between airport pairs within the corridor.

**Table 77. Intrastate Passenger Air Service City-Pair Market Distance.**

| Airport A | Airport B | Market Distance (Statute Miles) |
|-----------|-----------|---------------------------------|
| DFW       | HOU       | 247                             |
| DFW       | IAH       | 224                             |
| DAL       | HOU       | 239                             |
| DAL       | IAH       | 217                             |
| DFW       | CLL       | 164                             |
| IAH       | CLL       | 74                              |

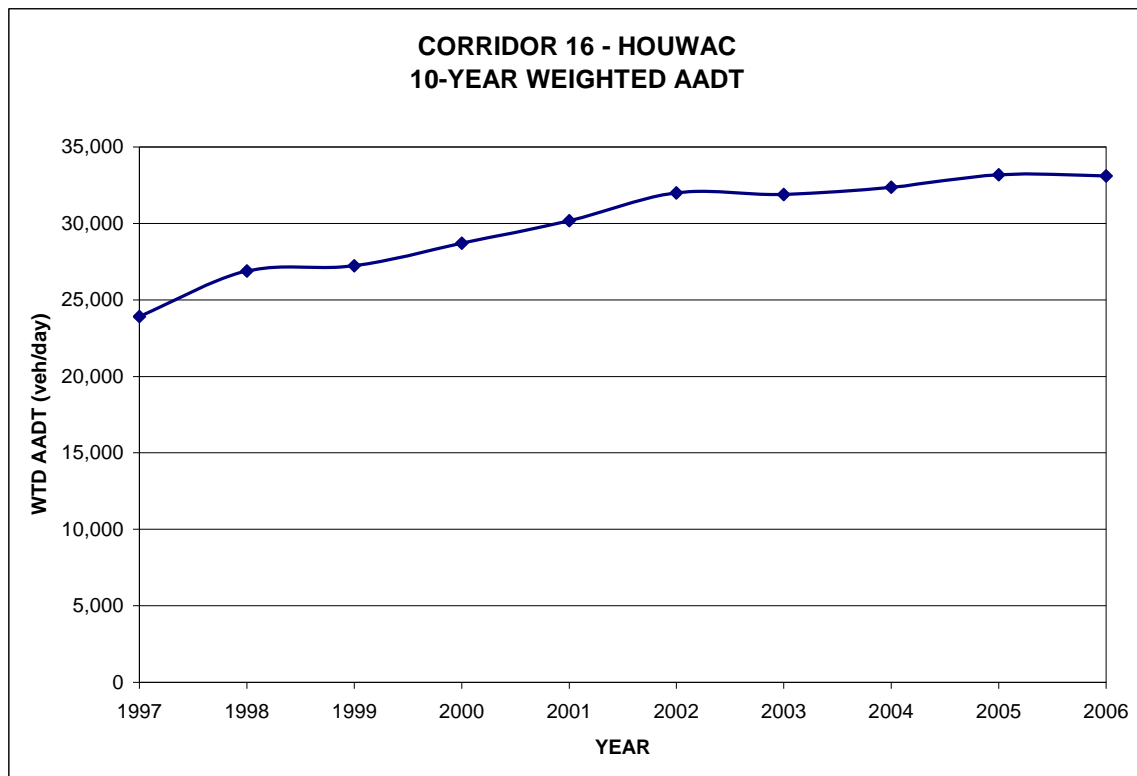
In 2006, the total number of air trips between Houston and Waco was 2,070, which is a 21.56 percent decrease compared to 1996. Between 1996 and 2008, specific indices for the air travel demand for Corridor Houston to Waco are shown in [Table 78](#).

**Table 78. Air Travel Demand for Corridor Houston-Waco from 1996 to 2008.**

| Year                                 | Number of Flights | Number of Passengers | Number of Seats | Load Factor |
|--------------------------------------|-------------------|----------------------|-----------------|-------------|
| 1996                                 | 6,295             | 67,618               | 157,106         | 0.43        |
| 2008                                 | 7,617             | 130,893              | 260,464         | 0.50        |
| 1996–2008<br>(Annual percent change) | 1.62%             | 7.20%                | 5.06%           | 1.29        |

*Corridor Travel Patterns: Highway*

The corridor segment between Houston and Waco experienced an annual increase in AADT of 3.85 percent between 1997 and 2006. Figure 86 shows the 10-year weighted AADT growth trend for this area. The projected AADT levels for the entire corridor are expected to reach over 92,000 vehicles per day along this corridor, as shown in Table 79.



**Figure 86. Corridor 16 – HOUWAC – 10-Year AADT.**

The Houston to Waco segment weighted corridor volume-to-capacity ratio in 2002 was 0.65, with a 1.0 representing a roadway at capacity. The 2035 projected V/C ratio worsens to an expected value of 1.71. This is shown in the 2002 and 2035 average speed over the corridor dropping from 44 mph in 2002 to 27 mph in 2035. Finally, the percent of trucks along the corridor is expected to remain consistent at 11–12 percent of overall traffic to 2035. Table 79 shows the highway travel statistics for the Houston to Waco segment prior to intersecting with the I-35 corridor as studied in Project 0-5930.

**Table 79. Houston to Waco Highway Travel Patterns.**

| <b>Data Element</b>                                  | <b>Houston to Waco</b>                             |
|--|--|
| % Annual Growth in Average Corridor AADT (1997–2006) | 3.85%  |
| Average Corridor AADT<br>2006<br>2035                | 33,112 vehicles per day<br>92,762 vehicles per day |
| Average Volume-to-Capacity Ratio<br>2002<br>2035     | 0.65<br>1.71                                       |
| Average Speed<br>2002<br>2035                        | 44 mph<br>27 mph                                   |
| Average % Trucks<br>2002<br>2035                     | 11.5%<br>11.9%                                     |

**Existing Passenger Rail, Bus Transit, Air Services, and Freight Rail**

The following sections summarize the existing transit and freight rail services and routes in the Houston to Dallas Fort Worth via Waco Corridor area. These services overlap in several cases with those described previously for the I-45 direct corridor.

*Existing Passenger Rail Service*

No existing passenger rail service is available on this corridor. Previous Amtrak routes between Dallas-Fort Worth and Houston served the College Station area before being discontinued in the mid-1990s.

*Existing Bus Service*

In this corridor, Greyhound provides intercity bus service two times daily between Dallas and Houston via Waco and Bryan/College Station and one time daily between Fort Worth and Houston via Waco and Bryan/College Station. The Kerrville Bus Company provides interlined service with Greyhound once daily from Houston to Waco via Austin.

*Intermodal Facilities*

Intermodal facilities include passenger train stations, bus stops/stations, transit centers, and other facilities that could potentially become intermodal facilities if market demands and development allows. In the Houston to Dallas/Fort Worth via Waco Corridor, specific facilities are as follows:

- |                                   |                              |
|-----------------------------------|------------------------------|
| Arlington Greyhound station       | Hearne Greyhound Station     |
| Bryan Greyhound station           | Hillsboro Greyhound bus stop |
| Corsicana Greyhound station       | Houston Amtrak station       |
| Dallas AAU Westmoreland Greyhound | Houston Greyhound stations   |

|   |                                |
|---|--------------------------------|
| station                                     | Navasota Greyhound station     |
| Dallas Union Station                        | Prairie View Greyhound station |
| Dallas South Park Greyhound station         | Waco Intermodal Transit Center |
| Fort Worth AAU                              | Waco Greyhound station         |
| Fort Worth Greyhound station                | Waxahachie Greyhound station   |
| Fort Worth Intermodal Transportation Center |                                |

A new Houston Northern Intermodal Facility has been planned/proposed to be established in the corridor.

*Transit Agencies*

The corridor of Houston to Dallas/Fort Worth via Waco goes through four planning regions. There are nine existing transit agencies along the corridor, namely:

|   |                               |
|---|-------------------------------|
| Connect Transportation (Texas City)                                   | The District (Brazos Transit) |
| Dallas Area Rapid Transit (DART)                                      | The T (Fort Worth)            |
| Fort Bend County Transit  | Waco Streak                   |
| Heart of Texas Council of Governments (HOTCOG) Rural Transit          | Waco Transit                  |
| Metropolitan Transit Authority of Harris County Houston Texas (METRO) |                               |

*Existing Freight Rail Operations*

Two existing Union Pacific-owned freight rail lines run within the Houston to Waco Corridor: Houston to Navasota via Hempstead, and Navasota to Waco. The former rail line parallels US 290 and turns north just east of Brenham, where it predominantly parallels TX 6. The latter runs parallel to TX 6. [Table 80](#) represents the current train volumes as obtained from the freight railroad operators and various freight movement mobility studies conducted by TxDOT, and future train volumes per rail line segment based on an annualized growth rate of 3 percent.

**Table 80. Segment Density and Rail Volumes (Houston to Waco).**

| Segment             | Current Volume (trains per day) | Future Volume* (trains per day) | Growth (trains per day) | Percent Growth | Segment Density (MGTM/Mi) |
|---------------------|---------------------------------|---------------------------------|-------------------------|----------------|---------------------------|
| Houston to Navasota | 5–10                            | 20–30                           | 15–20                   | 100–200        | 5–10                      |
| Navasota to Waco    | 15–20                           | 40–50                           | 25–30                   | 100–150        | 30–35                     |

\*by year of 2035, excludes passenger rail

Based on these current and forecast train levels and available capacity, the *National Rail Freight Infrastructure Capacity and Investment Study* (2007) presented an LOS estimate for these corridors. It is estimated that several of these line segments will experience LOS ‘D’ (approaching theoretical capacity) or worse in 2035 unless significant infrastructure improvements are undertaken. [Table 74](#) shows the current and projected LOS for the possible routes as identified in the 2007 *Capacity and Investment Study*.

## REFERENCES

- National Rail Freight Infrastructure Capacity and Investment Study* (2007)  
*Capacity and Investment Study* (2007)
- TxDOT Research Project 0-5930 *Potential for Development of a Rail/Express Bus Intercity Transit System in Texas*
- Carter-Burgess *Gulf Coast High-Speed Rail Corridor Evaluation: Houston to Echo, Texas High-Speed Rail Corridor Phased Implementation Plan* (2004)
- Morrison Knudsen Corporation *Gulf Coast High Speed Rail Corridor, Phase II Report* (1998)
- National Rail Freight Infrastructure Capacity and Investment Study* (2008)
- National Transportation Atlas Database* (2007)