

Project 0-4588
Seminar: 0-4588-P2
Effect of Voids in Grouted, Post-Tensioned
Concrete Bridge Construction

Texas Department of Transportation, Austin, Texas
February 26, 2009



TxDOT Program Coordinator: Brian Merrill and Randy Cox
TxDOT Project Directors: German Claros, Maxine Jacoby, & Jaime Sanchez
TxDOT Project Advisors: Brian Merrill, Kenny Ozuna, Tom Rummel,
Dean Van Landuyt, Steve Strmiska, and Keith Ramsey



TAMU / TTI Researchers: David Trejo (RS), Mary Beth Hueste (Co-RS),
Paolo Gardoni, Ken Reinschmidt, and Stefan Hurllebaus



Student Researchers: Radhakrishna Pillai, Seok Been Im, Suresh Kataria,
Michael Gamble, and Thanh Tat Ngo

Outline



- Research motivation
- Research objectives
- Research methods and findings
- Conclusions and recommendations

Research motivation

- Voids have been found in the ducts of post-tensioned (PT), segmental, concrete bridges
- Corrosion of strands has been identified in the ducts with voids



PT ducts inside a typical segmental box girder



Voids inside PT ducts



Corroded strands inside PT ducts with voids

- These conditions raised the following questions:
 - What are the critical parameters affecting void formation, strand corrosion, and repair grout performance?
 - What is the impact of strand corrosion on the structural reliability of PT bridges?
 - Do PT bridges need to be repaired?
 - If repairs are needed, how should the repairs be performed to economically maintain the required safety and performance?

Outline

- Research motivation
- Research objectives
- Research methods and findings
- Conclusions and recommendations



Research objectives

1. Assess environmental conditions at PT bridge locations in Texas
2. Identify critical environmental, void, and stress parameters affecting corrosion and tension capacity of PT strands
3. Develop methods to detect and assess the void, water, and corrosion conditions in PT systems
4. Assess the structural reliability of PT bridges during their service life and when exposed to various environmental and tendon conditions
5. Identify critical material parameters affecting void fillability of PT grouts and, if needed, recommend modifications to PT grout specifications
6. Develop a repair grouting procedure



Outline

- Research motivation
- Research objectives
- Research methods and findings
 1. Environmental conditions in PT bridge locations
 2. Corrosion and tension capacity behavior of PT strands
 3. Structural reliability of PT bridges
 4. Inspection of PT systems to detect voids, water, and strand corrosion conditions
 5. Repair grout characteristics and repair grouting procedures
- Conclusions and recommendations

Outline

- Research motivation
- Research objectives
- Research methods and findings
 1. Environmental conditions in PT bridge locations
 2. Corrosion and tension capacity behavior of PT strands
 3. Structural reliability of PT bridges
 4. Inspection of PT systems to detect voids, water, and strand corrosion conditions
 5. Repair grout characteristics and repair grouting procedures
- Conclusions and recommendations

Environmental conditions in PT bridge locations

Northern, eastern, and coastal regions in Texas have potentially moderate to severe environmental conditions for PT bridges

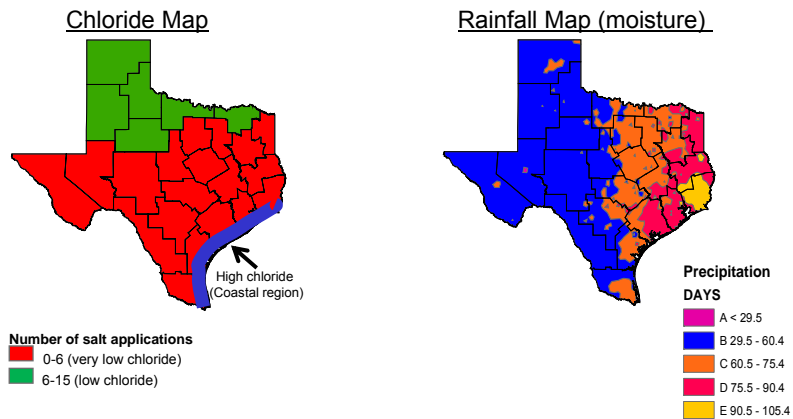



Major PT bridges are located in potentially severe environmental conditions

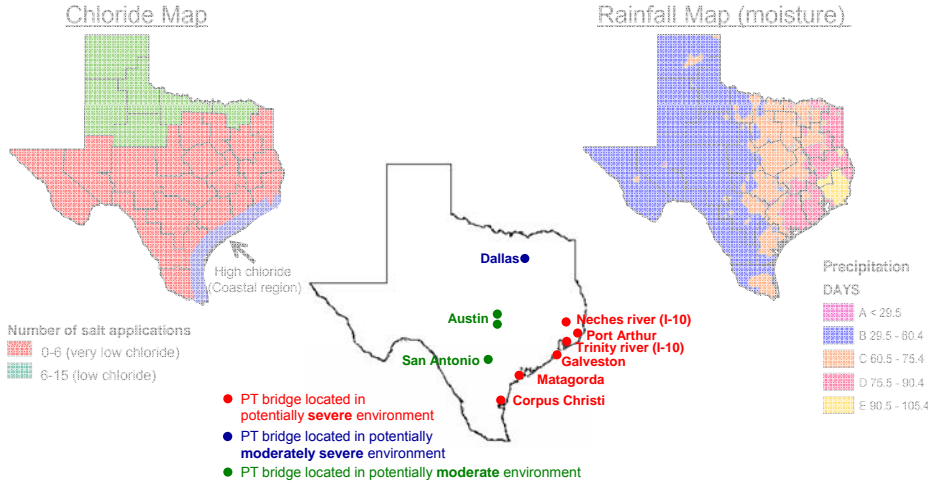

- Six out of ten PT bridges are located in a potentially severe environment
- One PT bridge is located in a potentially moderately severe environment
- The remaining three PT bridges are located in a potentially moderate environment



The rate of corrosion and tension capacity loss of strands vary depending on the exposure conditions

- Strand exposure conditions are affected by the presence of voids and tendon damage
- The rate of corrosion and the tension capacity loss of the strands increase as the severity of the exposure conditions increase

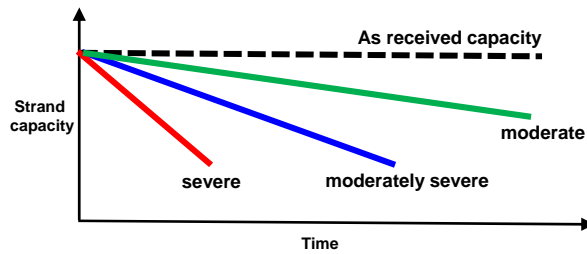

A conceptual schematic showing the capacity loss of strands

Outline

- Research motivation
- Research objectives
- Research methods and findings
 1. Environmental conditions in PT bridge locations
 2. Corrosion and tension capacity behavior of PT strands
 3. Structural reliability of PT bridges
 4. Inspection of PT systems to detect voids, water, and strand corrosion conditions
 5. Repair grout characteristics and repair grouting procedures
- Conclusions and recommendations

Corrosion and tension capacity behavior of PT strands

The environmental and tendon conditions can potentially influence the corrosion and tension capacity of PT strands

- **Environmental conditions** are relative humidity, temperature, and the presence of water and/or chlorides inside the tendons

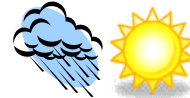



The environmental and tendon conditions can potentially influence the corrosion and tension capacity of PT strands

- **Environmental conditions** are relative humidity, temperature, and the presence of water and/or chlorides inside the tendons
- **Tendon conditions** are the presence of voids in PT systems and stress on PT strands



The environmental and tendon conditions can potentially influence the corrosion and tension capacity of PT strands

- **Environmental conditions** are relative humidity, temperature, and the presence of water and/or chlorides inside the tendons
- **Tendon conditions** are the presence of voids in PT systems and stress on PT strands
- **Exposure time** is also an influencing factor

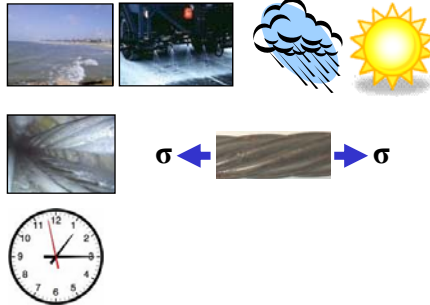



The exposure and tendon conditions can potentially influence the corrosion and tension capacity of PT strands

- **Exposure conditions** are relative humidity, temperature, and the presence of water and/or chlorides inside the tendons
- **Tendon conditions** are the presence of voids in PT systems and stress on PT strands
- **Exposure time** is also an influencing factor
- However, the nature and degree of influence of these factors on corrosion and tension capacity of PT strands is unknown

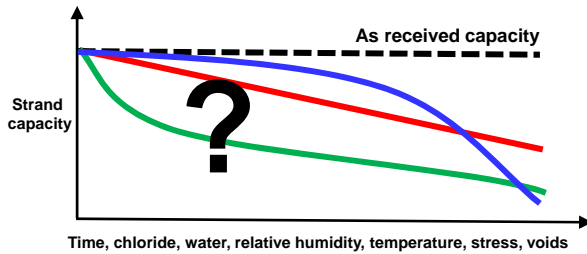

• Electrochemical characteristics of PT systems under various exposure conditions were assessed

• Models for the tension capacity of strands (as a function of exposure and tendon conditions and time) were developed



An experimental program to assess corrosion and tension capacity behavior of PT systems was conducted

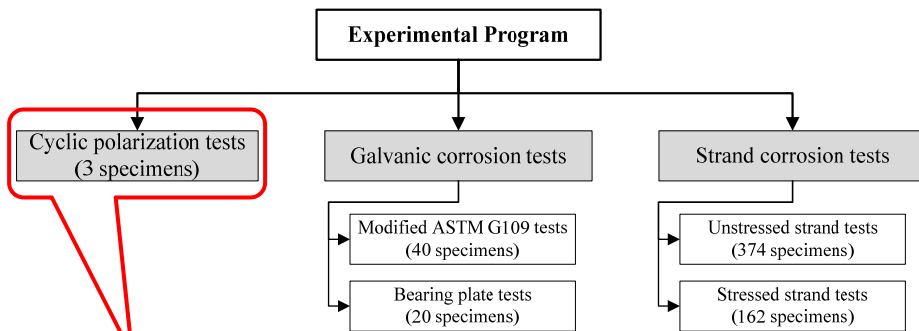

The objective was to determine the corrosion characteristics of prestressing steel when immersed in simulated pore solutions with different chloride concentrations



Cyclic polarization tests indicated that the presence of chlorides significantly influences the electrochemical behavior of strands

- The cyclic polarization test setup is shown below

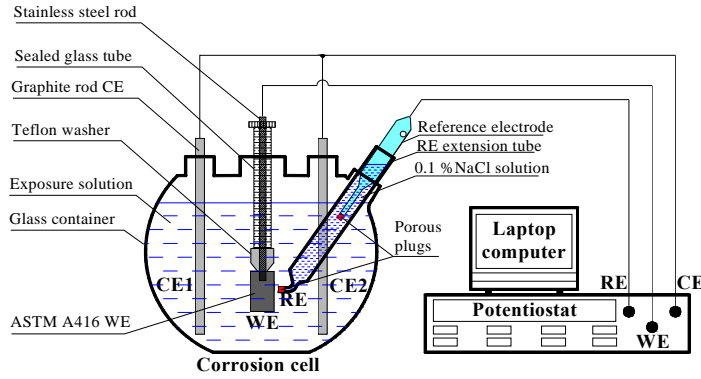

Notes
 CE - Counter electrode (Graphite rod)
 RE - Reference electrode (Saturated Calomel electrode with 0.241 V vs SHE)
 WE - Working electrode (ASTM A416 steel wire)

Test setup for cyclic polarization test (not to scale)



Cyclic polarization tests indicated that the presence of chlorides significantly influences the electrochemical behavior of strands

- As the chloride concentration increases, the breakdown potential, E_b , decreases and the passivation potential, E_{pp} , increases.
- Negative and positive hysteresis were observed with 0 and 1.8% chloride solutions, respectively.

- The passive region decreases as the chloride concentration increases
- The presence of chlorides can cause an increase of ~ 3 orders of magnitude in the corrosion rate
- Repassivation does not occur when chlorides are present

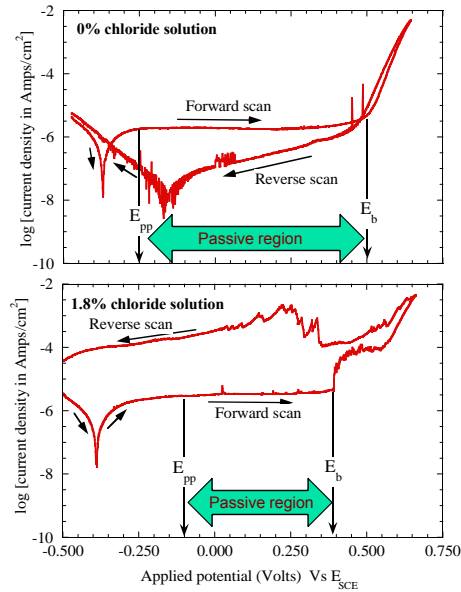

An experimental program to assess corrosion and tension capacity behavior of PT systems was conducted

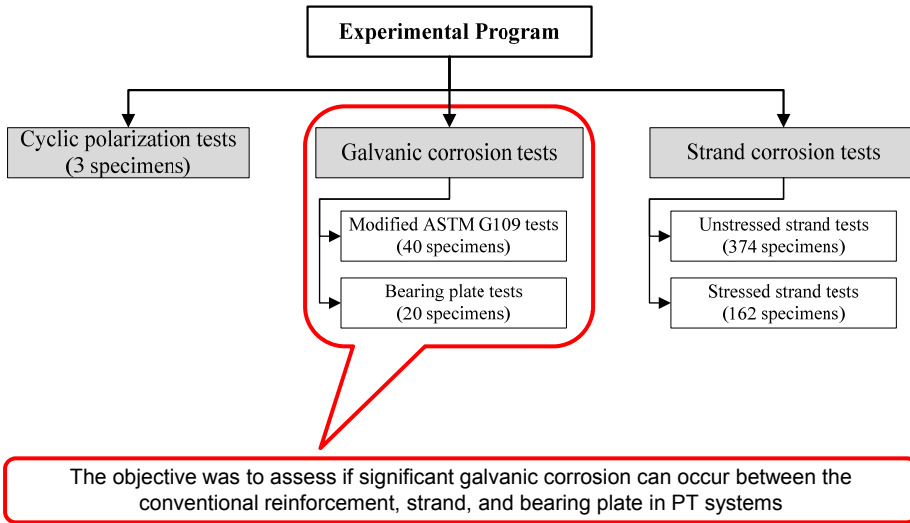

Modified ASTM G109 Test shows that no significant galvanic corrosion occurs between the conventional reinforcement and strands

- 20 specimens with strands at bottom and 20 specimens with conventional rebar at bottom were prepared and evaluated
- These specimens were then exposed to wet-dry cycles with 0 and 9% chloride solutions for 10 months

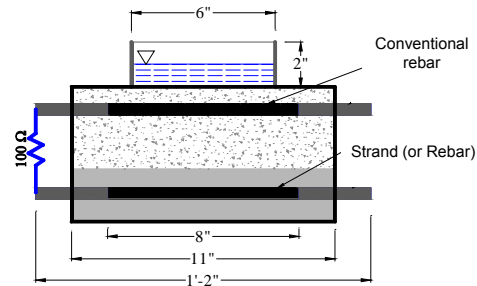
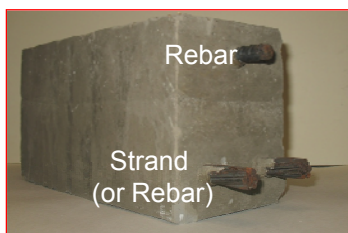

• No significant galvanic corrosion occurs between the conventional reinforcement and prestressing strands

Bearing-plate Test shows that significant galvanic corrosion can occur between the conventional reinforcement and bearing plates

- 20 specimens with conventional spiral reinforcement and cast iron bearing plates were prepared
- These specimens were then exposed to wet-dry cycles with 0 and 9% chloride solutions for 10 months

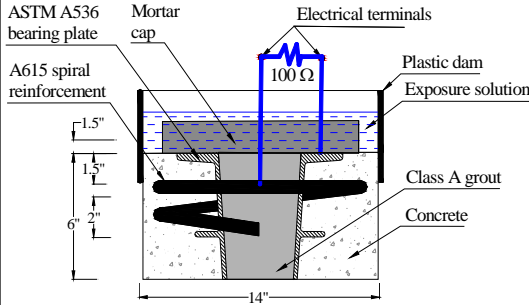

- Galvanic corrosion can occur between the conventional reinforcement and bearing plate and between the prestressing strand and bearing plate.
- Coating the bearing plate surface with a dielectric material may be beneficial

An experimental program to assess corrosion and tension capacity behavior of PT systems was conducted

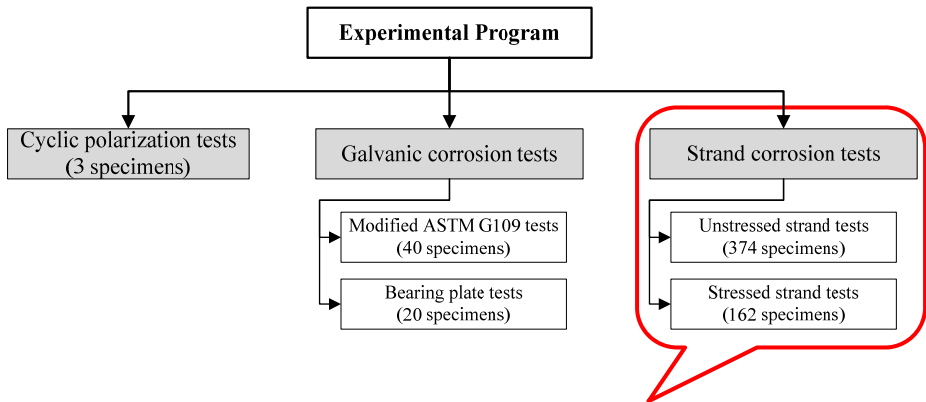

- The objectives were to identify critical parameters affecting corrosion and tension capacity of PT strands and generate the data necessary to develop probabilistic models for tension capacity of PT strands

Both unstressed and stressed strand corrosion tests were tested to develop capacity models

- The strands in PT bridges experience high axial stress
 - Corrosion and tension capacity behavior of stressed strands were not found in literature
 - Corrosion and tension capacity behavior of stressed strands could be significantly different from that of unstressed strands
- The researchers assessed the capacity of strands in various exposure and stress conditions
- Test data were used to correlate the different conditions with actual strand capacity



Unstressed strand samples

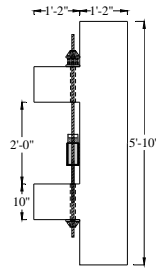

Stressed strand samples (on a concrete reaction frame)

Void types were simulated by forming grout-air-strand interfaces that represent field conditions

- **Parallel voids** - typically found in the horizontal portion of a tendon in a PT girder
- **Orthogonal voids** - typically found in the PT columns with vertical profile
- **Inclined and bleedwater voids** - typically found in the inclined tendons at the anchorage zones of a PT girder

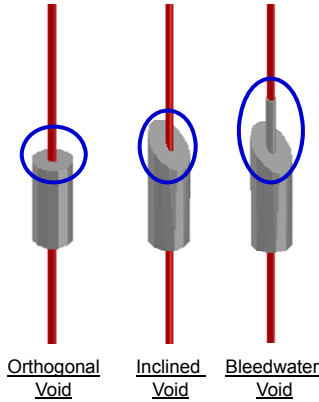
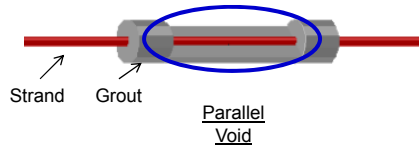

- Orthogonal, inclined, bleedwater void types have statistically similar effects on the tension capacity of strands
- The localized corrosion associated with these void types (typically located at girder anchorages and columns) are more severe than the parallel void type (typically located at the midspan of a girder)

Unstressed and stressed strand specimens with simulated void types were then exposed to...

- **Moisture Conditions**
 - No moisture (dry condition)
 - moisture (wet-dry condition)
- **Chloride Levels**
 - Unstressed samples - 0.006, 0.018, 0.18, and 1.8 %Cl⁻ solutions
 - Stressed samples - 0.006, 0.18, and 1.8 %Cl⁻ solutions
- **Exposure Time**
 - Unstressed samples – 0, 12, and 21 months
 - Stressed samples – 0, 12, 16, and 21 months

The data from strand corrosion tests were used to identify the critical parameters affecting tension capacity of strands

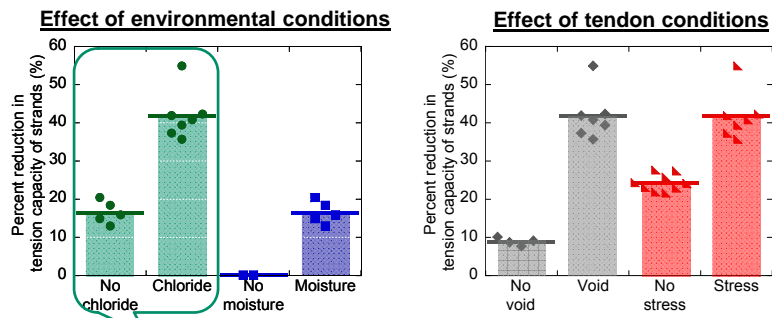

The presence of chlorides can reduce the strand capacity by an additional ~25% in 21 months

The data from strand corrosion tests were used to identify the critical parameters affecting tension capacity of strands

Effect of environmental conditions

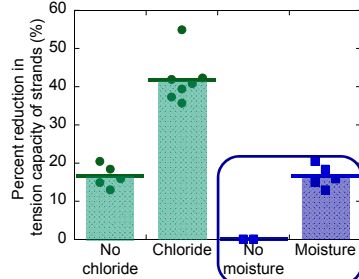

Effect of tendon conditions

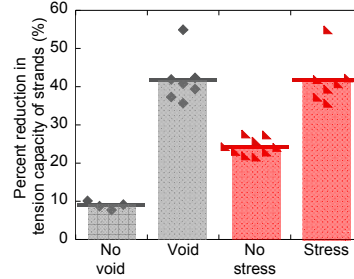

The presence of moisture can reduce the strand capacity by an additional ~17% in 21 months

The data from strand corrosion tests were used to identify the critical parameters affecting tension capacity of strands

Effect of environmental conditions

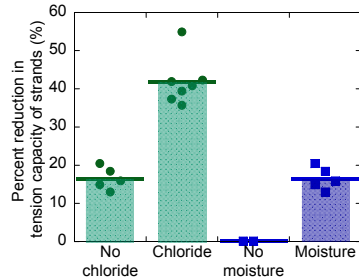

Effect of tendon conditions

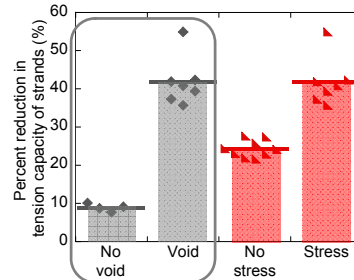

The presence of voids can reduce the strand capacity by an additional ~33% in 21 months

The data from strand corrosion tests were used to identify the critical parameters affecting tension capacity of strands

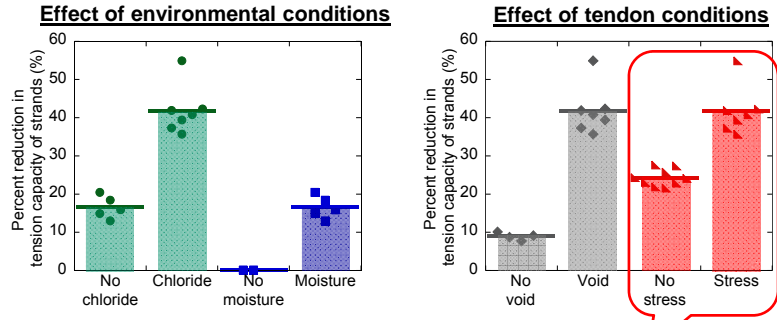

The presence of stress can reduce the strand capacity by an additional ~17% in 21 months

The data from strand corrosion tests were used to identify the critical parameters affecting tension capacity of strands

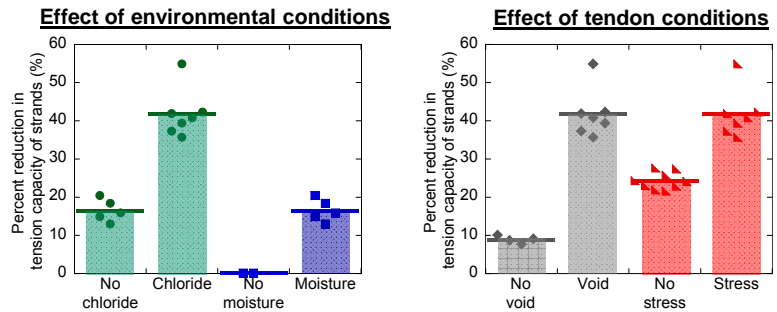

- The effects of these environmental and tendon conditions on the structural reliability need to be assessed
- Probabilistic models for the tension capacity of strands are needed to develop structural reliability models



Probabilistic models were developed and showed that chlorides and voids can significantly reduce the tension capacity of strands

- The presence of chlorides can cause significantly reduce the tension capacity of strands even under No Void (NV) conditions
- Bleedwater, Inclined, or Orthogonal Void (BIOV) types are more corrosive than the Parallel Void (PV) types

- Tension capacity of tendons can drop below the yield capacity in very young ages, if voids, water, or chlorides are present inside the tendons
- The time estimates obtained from the capacity models are consistent with the tendon failures observed in Florida and Virginia
- The effects of this tension capacity loss on the structural reliability were assessed

The plots shown are based on the assumption that there is a 2 months of wet time in every year

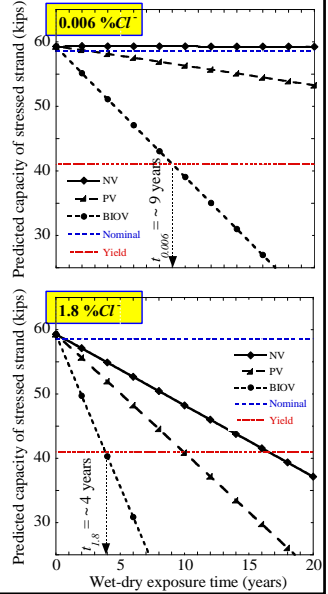

Outline

- Research motivation
- Research objectives
- Research methods and findings
 1. Environmental conditions in PT bridge locations
 2. Corrosion and tension capacity behavior of PT strands
 3. Structural reliability of PT bridges
 4. Inspection of PT systems to detect void, water, and strand corrosion conditions
 5. Repair grout characteristics and repair grouting procedures
- Conclusions and recommendations



An introduction to structural reliability of bridges

- Structural reliability techniques can combine the probabilistic material parameters (such as compressive strength of concrete, tension capacity of strands) into structural capacity models that predict the probability of structural failure.
- Two types of structural reliability can be used to assess the performance of a bridge
 - Strength reliability for assessing the safety of a bridge can be assessed using applied bending moment and flexural capacity
 - Service reliability for assessing the serviceability of a bridge can be assessed using compressive and tensile stresses at mid-span when subjected to loadings
- Flexural equations in the AASHTO (2007) code were calibrated for a reliability index equal to 3.5, which corresponds to 0.23% failure probability
- AASHTO (2007) does not recommend any values for service reliability
- ISO 13822 recommends a target value of 1.5 for service reliability

In this study, a typical PT bridge was defined as follows:

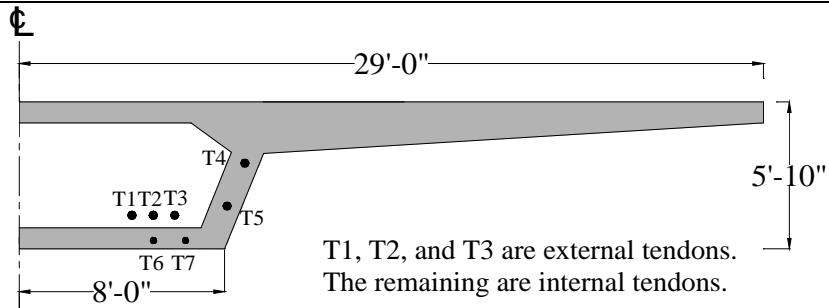

Cross-section of a typical segmental box girder with 14 tendons and a span of 100 feet



Safety can decrease if water infiltrate the voided tendons

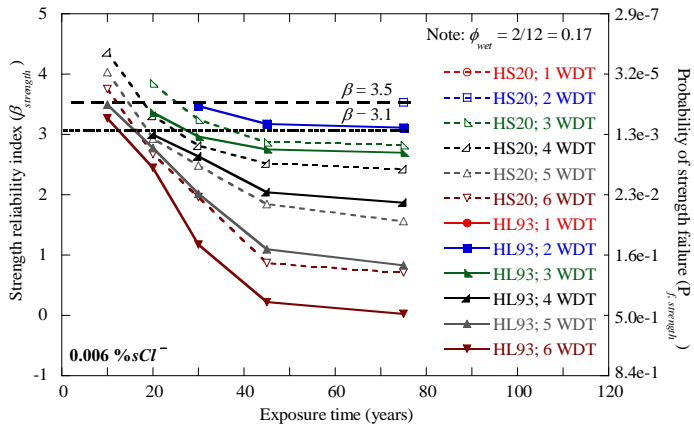

- Bridge tendons with voids exposed to severe moisture conditions lead to a severe reduction in strength reliability



Safety can further decrease if water and chlorides infiltrate the voided tendons

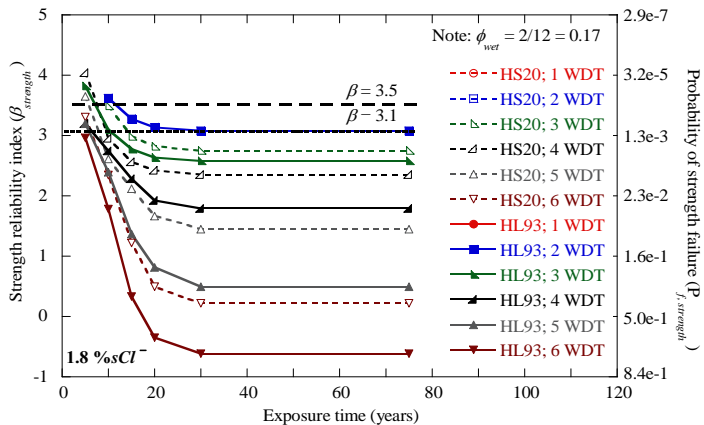

- Bridge tendons with voids exposed to severe moisture and chloride conditions lead to a severe reduction in strength reliability



Serviceability can decrease if water infiltrate the voided tendons

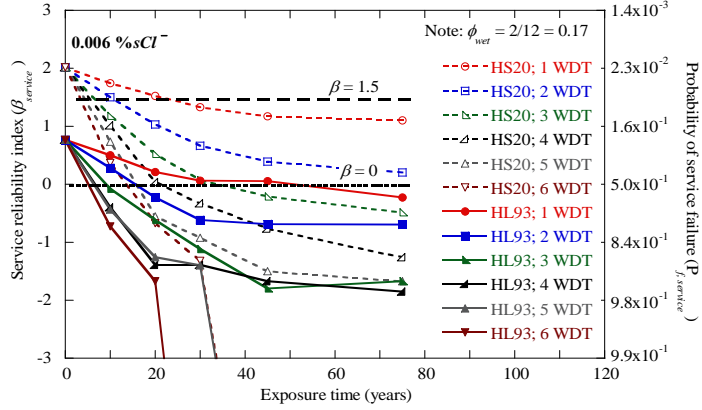

- Bridge tendons with voids exposed to severe moisture conditions lead to a severe reduction in service reliability



Serviceability can further decrease if water and chlorides infiltrate the voided tendons

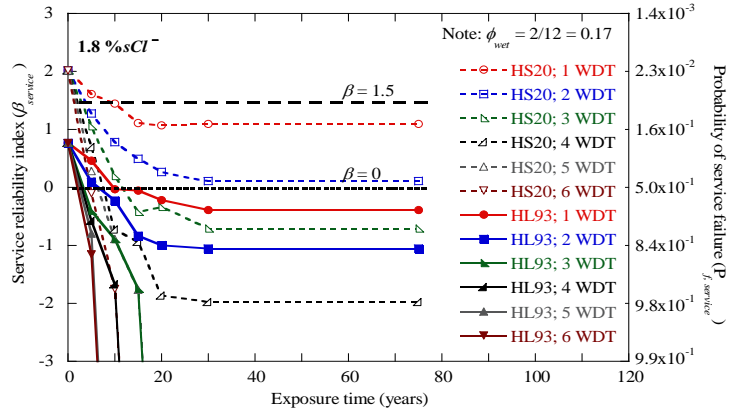

- Bridge tendons with voids exposed to severe moisture and chloride conditions lead to a severe reduction in service reliability

Outline

- Research motivation
- Research objectives
- Research methods and findings
 1. Environmental conditions in PT bridge locations
 2. Corrosion and tension capacity behavior of PT strands
 3. Structural reliability of PT bridges
 4. Inspection of PT systems to detect void, water, and strand corrosion conditions
 5. Repair grout characteristics and repair grouting procedures
- Conclusions and recommendations

Inspection of PT systems to detect void, water, and strand corrosion condition – Voids in tendon

To better predict the structural reliability of PT bridges we need the information on the presence of:

- Voids in tendons
- Water and chlorides in tendons
- Strand corrosion
- Damage to PT system

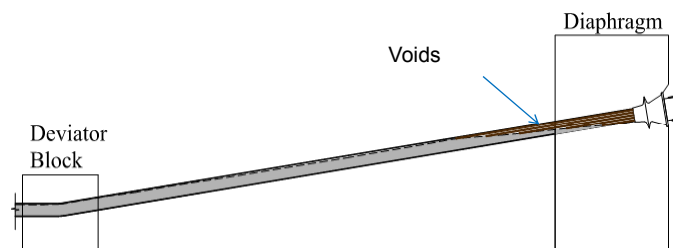



The researchers performed a literature review on the following NDT methods to assess their suitability for identifying voids

NDT methods	Pros	Cons
Computerized Radioactive Tomography	Accurate image Powerful visualization	Expensive Inconvenient accessibility
Infrared Thermography	Fast and cost-effective	Expertise needed for evaluation Not applicable in HDPE duct
Magnetic Flux Leakage	Detects the corrosion of metallic material	Cannot detect voids without severe corrosion Sensitive to duct condition
Ultrasonic	Detects void, crack, and corrosion	High attenuation signal Scattered signal by aggregate
Impact Echo	Good signal-to-noise ratio in concrete structure Effective result in identifying voids	Bad visualization Expertise needed for testing
Sounding	Fast and easy to apply without a power supply	Uncertainty

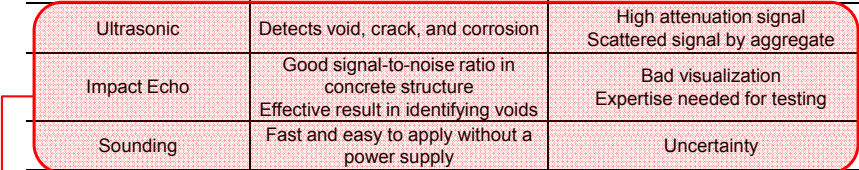

→ These methods will be further assessed

- Ultrasonic, impact echo, and sounding methods were assessed in laboratory to determine their suitability for identifying voids in tendons



The literature indicates that ultrasonic methods can detect voids, cracks, and corrosion in concrete

- However, the reflected signals are highly attenuated and it can be scattered by the aggregates inside concrete

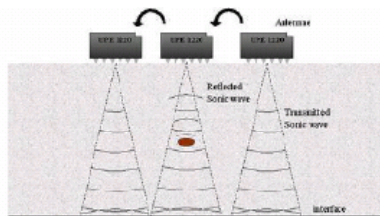

UPE scanner system

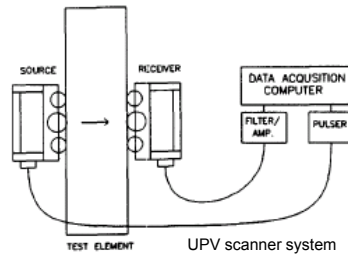

UPV scanner system

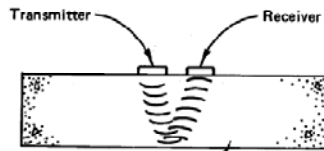

Pitch-catch scanner system

The literature indicates that the Impact Echo (IE) method has been shown to be effective for identifying voids in internal PT systems

- It is difficult to identify voids using IE methods when conditions include small, round elements such as tendons and is not applicable for external tendons

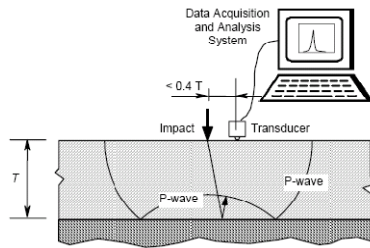

Tinkey and Olson (2007)

The literature indicates that the Sounding inspection methods are fast and can be used to easily identify voids in external PT tendons

- The literature shows that the sounding inspection method is commonly used to detect delaminated areas in concrete structures
- The sounding inspection method is subjective



Detecting delaminated areas in concrete bridge decks

Small scale testing in the laboratory showed that the ultrasonic method is not suitable for external tendons

- 16 specimens were designed and fabricated
- Voids were simulated using different size of plastic balls and styrofoam

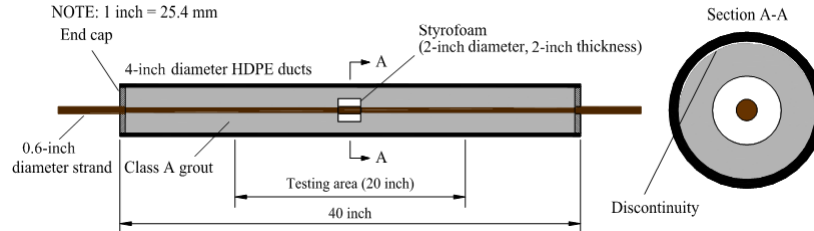

The schematic of small scale specimen including styrofoam void and strand

- The ultrasonic method is difficult to identify voids because of the discontinuity between the duct and grout
- Transmitter and receiver need couplant on the surface of specimens (because the couplant is a sticky resin, this method is inconvenient to apply in the field)

- Ultrasonic method is not effective for identifying voids in the external tendon
- Impact echo and sounding inspection methods are further assessed

A full scale laboratory test setup was designed and fabricated to assess the feasibility of the IE and sounding inspection methods

- 16 prototype external tendon specimens with voids were designed, fabricated, and tested
- The 19 strands were stressed of 0.8 ksi.
- Ducts were grouted with Class A grout
- Voids were simulated inside the duct
- Transparent ducts were used for this research to observe the filling of voids

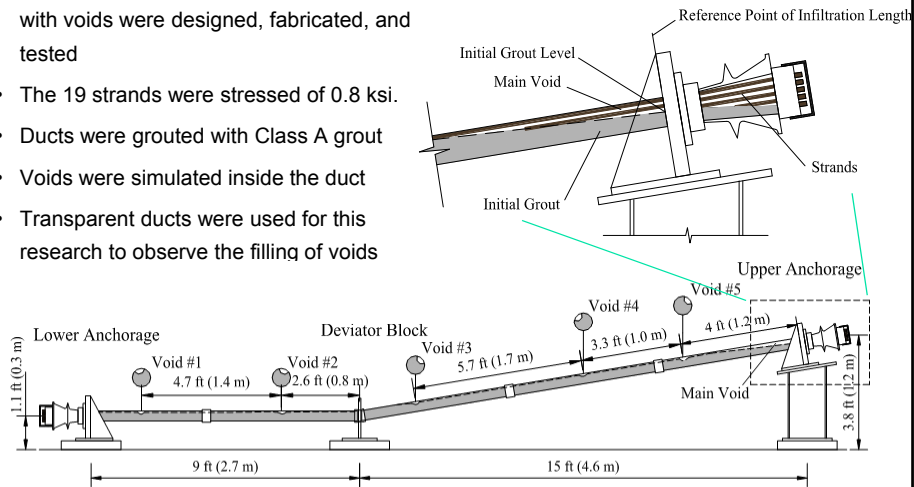

Note: For clarity the 19 strands inside the acrylic duct are not shown.

Prototype External Tendon Specimen

The suitability of Impact Echo (IE) method to identify voids was assessed using the full scale test setup

- The results obtained from the IE method were not repeatable
- It is difficult to apply the IE method without a medium for transmitting impact waves

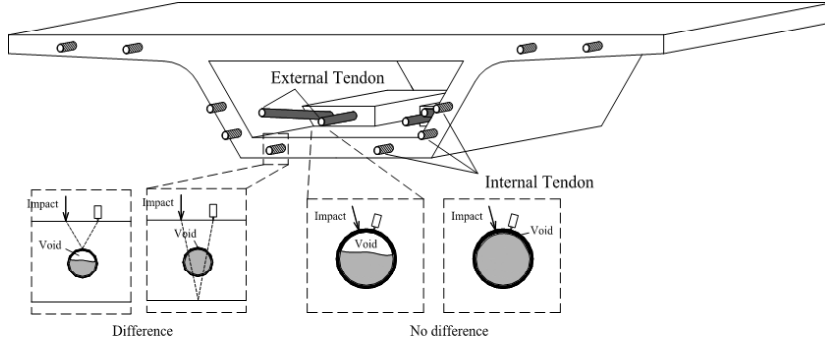

- The IE method is not effective for identifying voids in external tendons
- The IE method is sensitive to vibration and is difficult to use in the field

The suitability of Sounding Inspection method to identify voids was assessed using the full scale test setup

- The test methodology
 - uses a steel tapping hammer to identify the presence of voids in PT ducts
 - identifies voids by detecting a high pitch sound while tapping
 - uses subjective assessment of noise pitch
- The information is recorded on the “unrolled drawing” as shown:

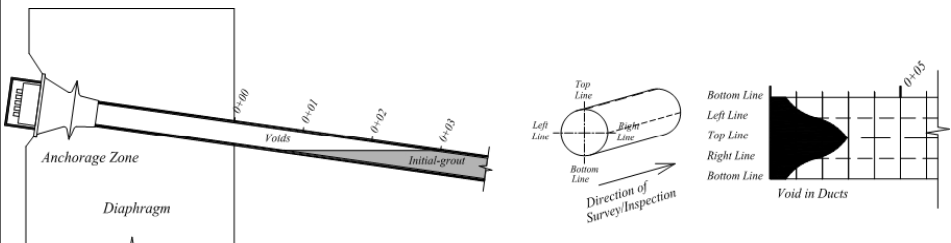
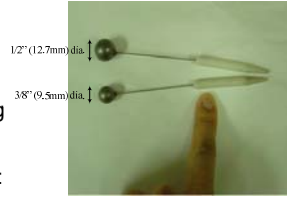

Marking void profiles using sounding inspection on unrolled drawing form



The void profiles obtained using sounding and visual inspections were compared

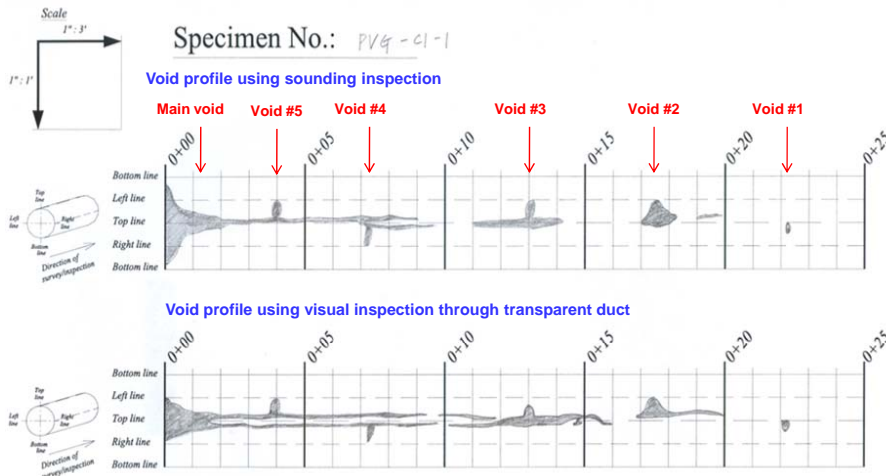

- The sounding inspection method can identify voids



Sounding inspection method was used to assess the presence of voids in the San Antonio “Y” bridge

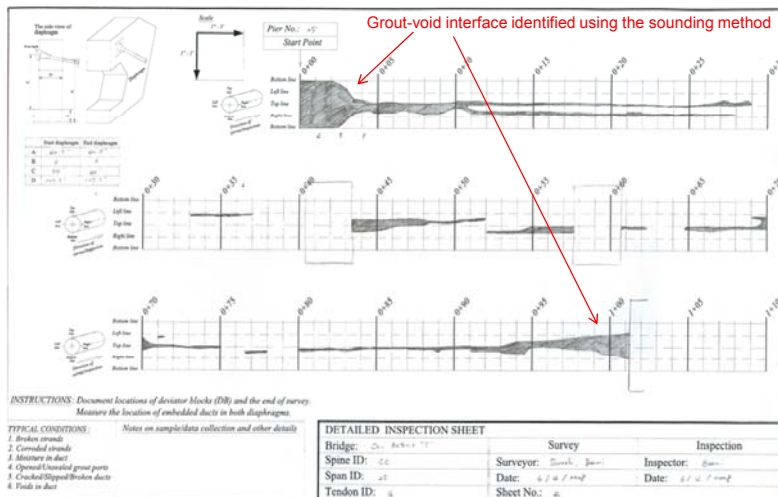

- The void profile in the bridge show the same trends as the laboratory sample and can be used to identify the grout-void interface in external tendons

Summary of void inspection in PT system

- Ultrasonic, Impact Echo, and Sounding Inspection methods were assessed

NDT test	Internal tendon	External tendon
Ultrasonic method	Not recommended	Not recommended
Impact Echo method	Need to assess in real bridge	Not recommended
Sounding inspection method	Not recommended	Recommended

- Sounding inspection method can be an effective tool for inspecting voids in external tendon system because of its ease of application and relative accuracy

To better predict the structural reliability of PT bridges we need the information on the presence of:

- Voids in tendon
- Water and chlorides in tendon
- Strand corrosion
- Damage to PT system

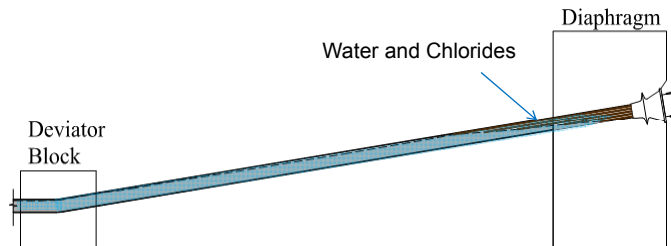



To identify the presence of water and/or chlorides in external tendons, the following strategy is devised

- Test procedure
 - **Using a dremel tool with a copper wire bit (1/8-inch diameter)**, drill the duct at the bottom of the lowest point of tendon
 - If water drains from the hole in the tendon, the solution can be collected to assess chlorides or other aggressive ions
 - Repair the hole
 - For more in-depth assessment, additional holes can be selected to identify water and/or chlorides in external tendon

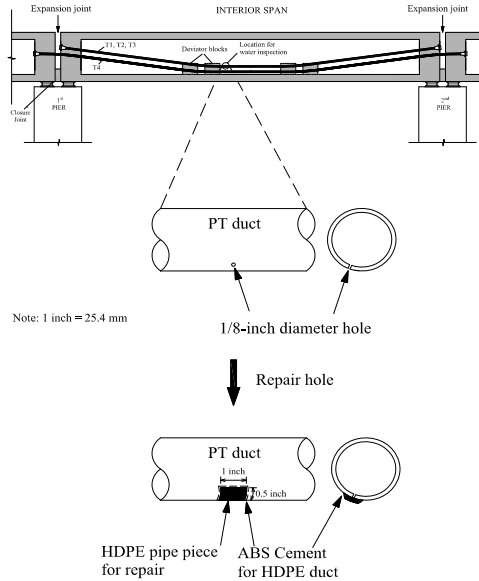

To better predict the structural reliability of PT bridges we need the information on the presence of:

- Voids in tendon
- Water and chlorides in tendon
- **Strand corrosion**
- Damage to PT system

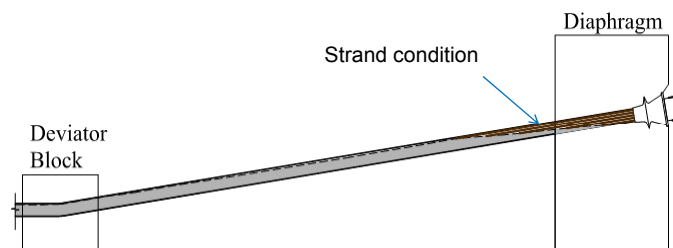

To identify the condition of the strands a borescope can be used

- Test procedure
 - Open the sealed grout port at anchor plate
 - Check the existence of voids inside the anchor plate using steel wire
 - Identify strand conditions inside the anchor plate using borescope

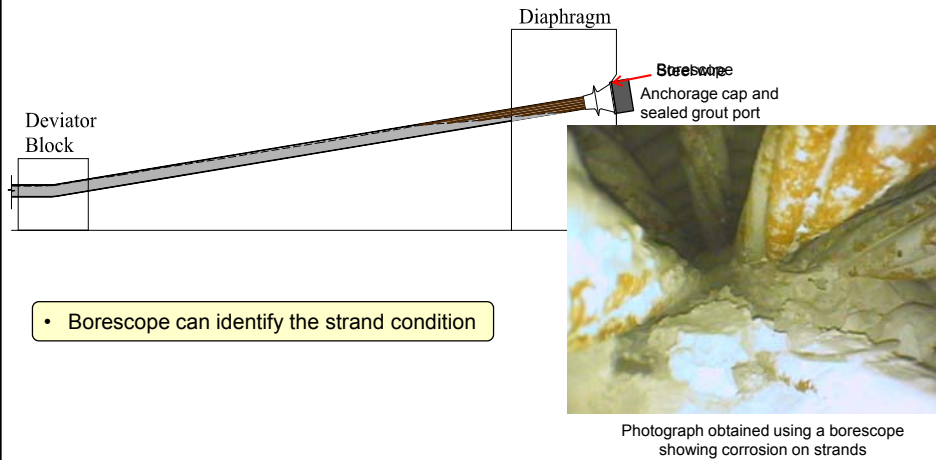

To better predict the structural reliability of PT bridges we need the information on the presence of:

- Voids in tendon
- Water and chlorides in tendon
- Strand corrosion
- Damage to PT system

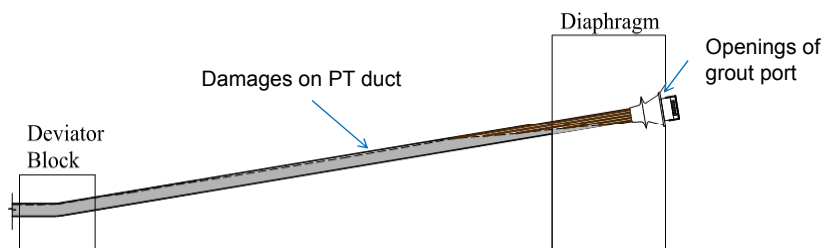

To identify potential damaging conditions in PT systems, the presence and source of water should be identified

- Standing water/moisture inside the box girder



To identify potential damaging conditions in PT systems, the presence of cracked ducts should be identified

- Cracked/broken PT duct and holes on duct



To identify potential damaging conditions in PT systems, the presence of broken drainage pipes should be identified

- Cracked/broken drainage pipe



To identify potential damaging conditions in PT systems, the presence of exposed anchorage plates should be identified

- Exposed anchorage plate



To identify potential damaging conditions in PT systems, the presence of open grout ports should be identified

- Open grout port



Outline

- Research motivation
- Research objectives
- Research methods and findings
 1. Environmental conditions in PT bridge locations
 2. Corrosion and tension capacity behavior of PT strands
 3. Structural reliability of PT bridges
 4. Inspection of void, water, and corrosion in PT systems
 5. Repair grout characteristics and repair grouting procedures
- Conclusions and recommendations

• Note that repair procedures should only be used if it is determined that galvanic cells do not form at the interface between the existing and repair grouts



To mitigate ongoing corrosion in tendon, the following research needs to be performed

- > Assessment of repair grout characteristics
- > Assessment of repair grouting methods



Conformance of commercially available grouts with DMS-4670 specification was assessed

Characteristic	Test standards followed	Grout Type			
		A	C-1	C-2	C-3
Wick-induced bleed	Tex-441-A	✗	√	√	√
Efflux time	Tex-437-A	✗	√	√	√
Viscosity	Brookfield Rheometer	NR	NR	NR	NR
Wet density	Baroid Mud Balance	NR	NR	NR	NR
Initial setting time	ASTM C953	√	√	√	√
Particle size	Tex-401-A	√	√	√	√
Compressive strength	ASTM C942	√	√	√	√
Volume change	ASTM C1090	√	√	√	√
Chloride diffusivity	ASTM C1556	NR	NR	NR	NR
pH	-	NR	NR	NR	NR
Fillability	-	NR	NR	NR	NR

- √ indicates that grout met DMS-4670 specification
- ✗ indicates that grout did not meet DMS-4670 specification
- NR indicates grout characteristic not required in DMS-4670 specification

Mud balance test needs to be included in DMS-4670 specification to ensure field quality of repair grouts

- Mud balance test is used to measure wet density and uniformity of the grout produced in the field as follows:

$$\rho_{\text{observed}} = \rho_{\text{predicted}} \pm 0.31$$

where, $\rho_{\text{predicted}} = -28.4 + 104.6(w/p) + 2.1(\rho_{\text{dry}})$ } for ρ values in lb/gal

$$\rho_{\text{observed}} = \rho_{\text{predicted}} \pm 0.04$$

where, $\rho_{\text{predicted}} = -3.4 + 12.5(w/p) + 2.1(\rho_{\text{dry}})$ } for ρ values in g/cm³



Baroid Mud Balance Apparatus

A method was determined to assess the fillability of repair grout

- Class C-1 and C-2 grouts performed well
- Class C-3 grout did not exhibit good fillability

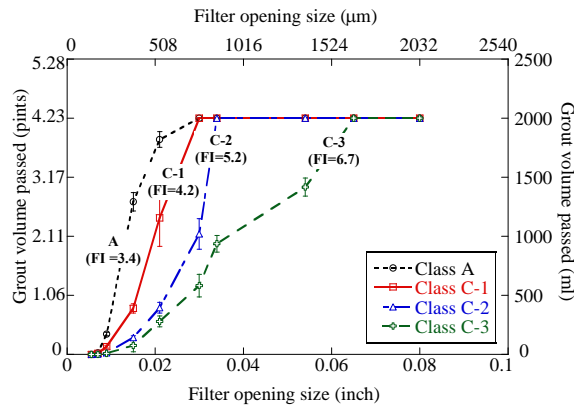

- Different commercially available Class C grouts can have different fillability indices
- It is recommended to include fillability test in DMS-4670 specification to well characterize the Class C grouts



The Class C-3 grout showed lower filling capability than Class C-1 and C-2 grouts

- C-3 grout does not meet Fillability Index (FI) requirement
- C-1 and C-2 grouts with larger FI can infiltrate deeper into the voids than C-3 grout

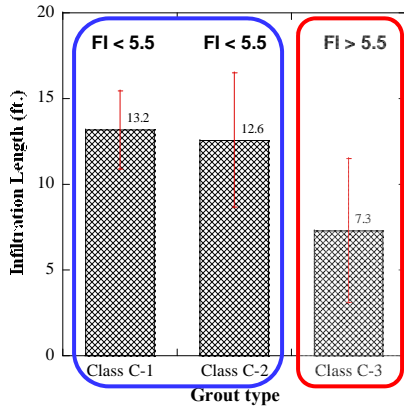

- Based on the analysis of variance (ANOVA), at a 0.05 level of significance (which is the probability of erroneously rejecting the hypothesis), the hypothesis that the mean infiltration lengths are all the same as different repair grouts can be rejected
- That is, there are statistically significant evidences to conclude that different repair grouts have different infiltration lengths
- From the Student-Newman-Keuls (SNK) test, the infiltration length of the Class C-3 grout have less infiltration length than others
- Therefore, the different repair grouting methods are assessed while considering the Class C-1 and C-2 grouts

• The C-1 and C-2 grouts have better filling capability than C-3



It is recommended to add the mud balance and fillability tests to the current DMS-4670 specification

Characteristic	Test standards followed	Grout Type			
		A	C-1	C-2	C-3
Wick-induced bleed	Tex-441-A	×	√	√	√
Efflux time	Tex-437-A	×	√	√	√
Viscosity	Brookfield Rheometer	NR	NR	NR	NR
Wet density	Baroid Mud Balance	Rec	Rec	Rec	Rec
Initial setting time	ASTM C953	√	√	√	√
Particle size	Tex-401-A	√	√	√	√
Compressive strength	ASTM C942	√	√	√	√
Volume change	ASTM C1090	√	√	√	√
Chloride diffusivity	ASTM C1556	NR	NR	NR	NR
pH	-	NR	NR	NR	NR
Fillability	-	√	√	√	×

- √ indicates that grout met DMS-4670 specification
- ×
- NR indicates grout characteristic not required in DMS-4670 specification
- Rec indicates that the modification of DMS-4670 are required

• Wet density and Fillability is not currently required, but it is critical to assess these characteristics of repair grouts

To mitigate ongoing corrosion in tendon, the following research needs to be performed

- Assessment of repair grout characteristics
- Assessment of repair grouting method

Three repair grouting methods were assessed for their filling capability, repair performance, and economic feasibility

- Pressure grouting method
- Vacuum grouting method
- Pressure-vacuum grouting method

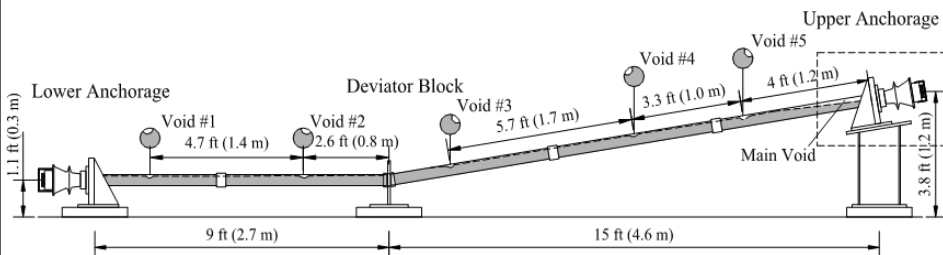

Note: For clarity the 19 strands inside the acrylic duct are not shown.

Prototype External Tendon Specimen

The cut sections of the full-scale specimens were assessed

- Sections were cut at every 6 inches up to 5 ft from reference point and at every 12 inches thereafter
- Void percent $(A_v/A_R) \times 100$ was estimated to compare the performance of repaired grout
- The minimum values of the repaired area in cut sections were evaluated to compare filling capability

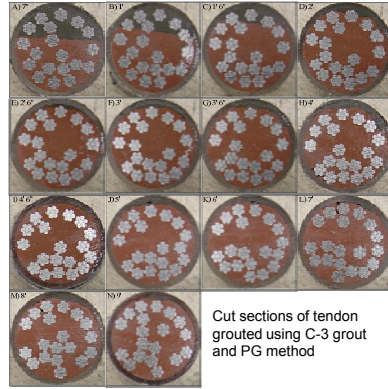
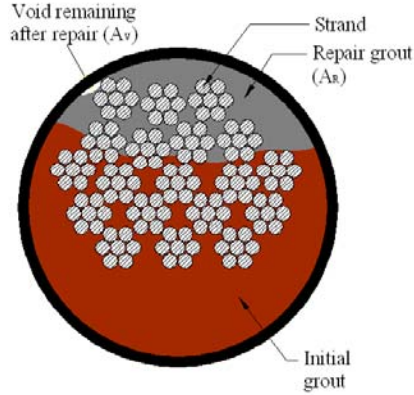
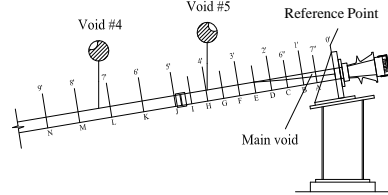

Three grouting procedures have been assessed for their efficiency and economic feasibility

- 27-foot long prototype tendon specimens with voids were prepared

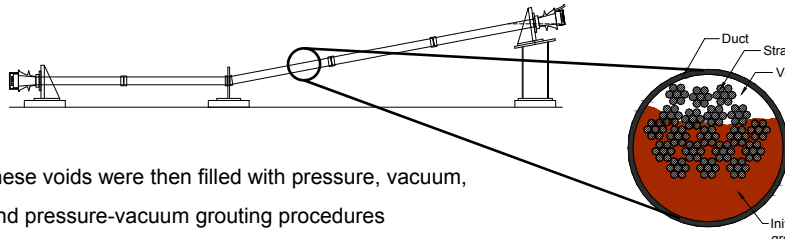

- These voids were then filled with pressure, vacuum, and pressure-vacuum grouting procedures

Tendon cross-section showing strands, voids, and initial grout

Three grouting procedures have been assessed for their efficiency and economic feasibility

- 27-foot long prototype tendon specimens with voids were prepared

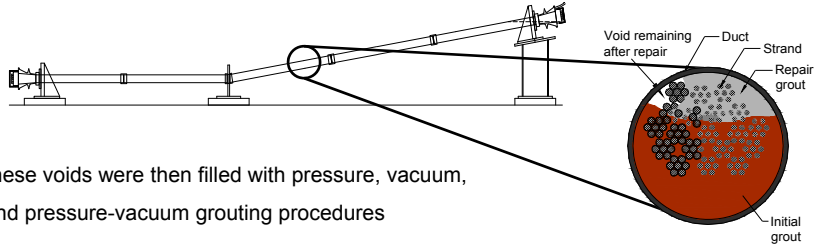

- These voids were then filled with pressure, vacuum, and pressure-vacuum grouting procedures
- **Pressure grouting** requires less preparation time (more constructable) but was found to leave voids unfilled (lower fillability)

Tendon cross-section showing strands, possible remaining voids, and initial and repair grout
(LOWER FILLABILITY)

Three grouting procedures have been assessed for their efficiency and economic feasibility

- 27-foot long prototype tendon specimens with voids were prepared

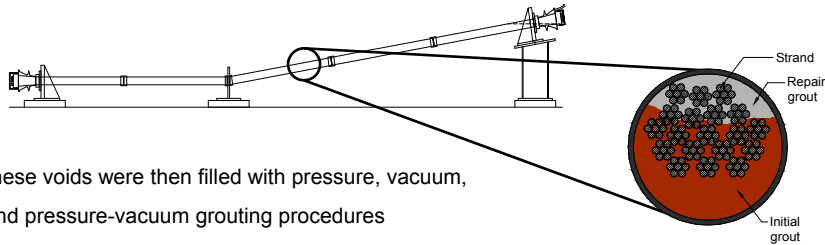

- These voids were then filled with pressure, vacuum, and pressure-vacuum grouting procedures
- **Pressure grouting** requires less preparation time (more constructable) but was found to leave voids unfilled (lower fillability)

Tendon cross-section showing strands, and initial and repair grout
(BETTER FILLABILITY)

- **Vacuum grouting** results in better fillability but is less constructable

Three grouting procedures have been assessed for their efficiency and economic feasibility

- 27-foot long prototype tendon specimens with voids were prepared

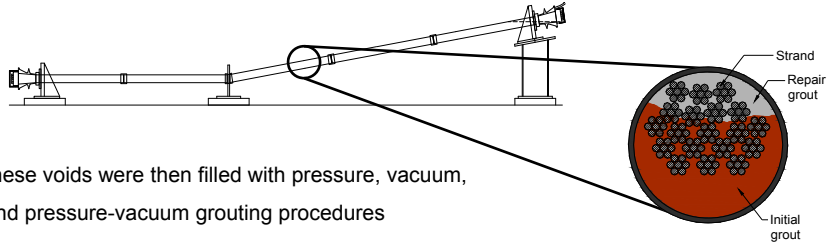

- These voids were then filled with pressure, vacuum, and pressure-vacuum grouting procedures
- **Pressure grouting** requires less preparation time (more constructable) but was found to leave voids unfilled (lower fillability)
- **Vacuum grouting** results in better fillability but is less constructable
- **Pressure-vacuum grouting** was found to be both constructable and to have better fillability

Tendon cross-section showing strands, and initial and repair grout (BETTER FILLABILITY)

Pressure-vacuum grouting is the most efficient option evaluated to fill the voids in PT ducts

Three grouting procedures have been assessed for their efficiency and economic feasibility

- 27-foot long prototype tendon specimens with voids were prepared

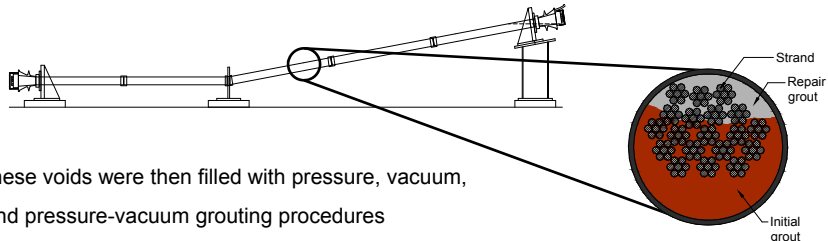

- These voids were then filled with pressure, vacuum, and pressure-vacuum grouting procedures
- **Pressure grouting** requires less preparation time (more constructable) but was found to leave voids unfilled (lower fillability)
- **Vacuum grouting** results in better fillability but is less constructable
- **Pressure-vacuum grouting** was found to be both constructable and to have better fillability

Tendon cross-section showing strands, and initial and repair grout (BETTER FILLABILITY)

• Note that pressure-vacuum repair grouting should only be performed if it is determined that galvanic cells do not form at the interface between the existing and repair grouts

Video of VG and PVG tests are shown



Test using VG method



Test using PVG method

- The PVG method fills voids faster than the VG method
- The PVG and VG methods seem to have better filling capability than the PG method
- The PG and PVG methods are less labor intensive than the VG method
- Therefore, the PVG method is recommended to fill voids in PT tendon

The VG and PVG methods seem to have better filling capability than the PG method

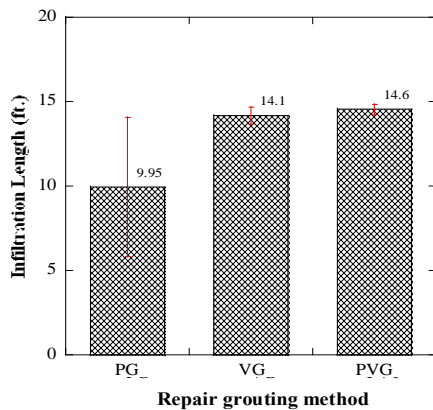

- Based on the ANOVA, at a 0.05 level of significance, the hypothesis that the mean infiltration lengths are all the same as different repair grouting method cannot be rejected
- That is, there is no statistically significant evidence to conclude that different repair grouting methods have different infiltration lengths
- However, the PG method seems to have less infiltration length than others

The PG and PVG methods are less labor intensive than the VG method

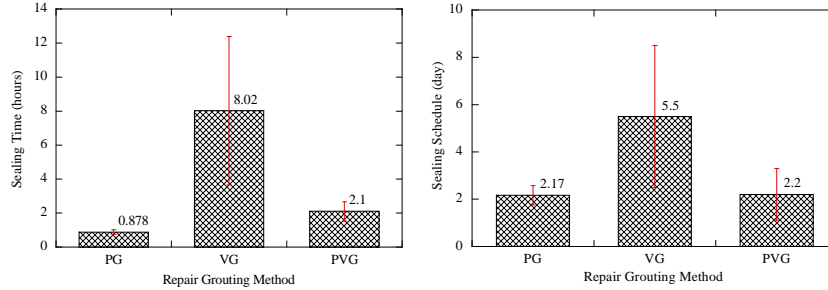

- Voids after repair are assessed in cut sections
 - Based on the ANOVA, at a 0.05 level of significance, the hypothesis that the mean sealing time is all the same as different repair grouting methods can be rejected.
 - That is, there is statistically significant evident to conclude that different grouting methods need different sealing time.
 - From the SNK test, the sealing time of the VG method have more preparation time than others.

Conclusions and recommendations

- It was found that
 - PT bridges in Texas are in severe, moderately severe, and moderate exposure conditions
 - The presence of voids and the exposure to moisture and chloride conditions results in significant reduction in tension capacity of PT strands
 - Such conditions can result in a significant reduction in the structural reliability of PT bridges at relatively young ages
 - Information from inspections can be used to better assess the reliability of PT bridges
 - Performing soundings on PT tendons is an effective approach for locating voids in tendons
 - The pressure-vacuum grouting procedure was found to be better than the pressure and vacuum grouting methods in filling voids in PT ducts
 - Not all Class C grouts exhibit good fillability and changes to the existing specification could result in the use of grouts with better fillability



Conclusions and recommendations

- It is recommended that:
 - Tendons be kept free of moisture and chlorides to avoid potential strand corrosion and resulting reductions in structural reliability
 - Because certain conditions can result in a significant reduction in the structural reliability of PT bridges, the reliability of all PT bridges in Texas be assessed
 - Information obtained from inspections that indicate aggressive conditions should be used to update the reliability of PT bridges in Texas
 - Sounding methods should be used to detect voids in PT tendons
 - If it is determined at a later date that galvanic corrosion is insignificant, the pressure-vacuum grouting procedure should be preferred over the pressure and vacuum methods to repair tendons
 - Changes to the existing specification (DMS 4670) should be implemented



Thank You