



TEXAS TECH UNIVERSITY

Multidisciplinary Research in Transportation

# Evaluating Existing Culverts for Load Capacity Allowing for Soil Structure Interaction

William D. Lawson, Timothy A. Wood,  
Charles D. Newhouse, Priyantha W. Jayawickrama

Texas Department of Transportation

Report #: 0-5849-1  
[www.techmrt.ttu.edu/reports.php](http://www.techmrt.ttu.edu/reports.php)

December 2010

## **NOTICE**

The United States Government and the State of Texas do not endorse products or manufacturers. Trade or manufacturers' names appear herein solely because they are considered essential to the object of this report

## TECHNICAL REPORT DOCUMENTATION PAGE

1. Report No.: FHWA/TX-10/0-5849-1	2. Government Accession No.:	3. Recipient's Catalog No.:	
4. Title and Subtitle: Evaluating Existing Culverts for Load Capacity Allowing for Soil Structure Interaction		5. Report Date: November 2010	
		6. Performing Organization Code:	
7. Author(s): William D. Lawson, Timothy A. Wood, Charles D. Newhouse, Priyantha W. Jayawickrama		8. Performing Organization Report No. 0-5849-1	
9. Performing Organization Name and Address: Texas Tech University College of Engineering Box 41023 Lubbock, Texas 79409-1023		10. Work Unit No. (TRAIS):	
		11. Contract or Grant No. : 0-5849	
12. Sponsoring Agency Name and Address Texas Department of Transportation Research and Technology Implementation Office P. O. Box 5080 Austin, TX 78763-5080		13. Type of Report and Period Cover: Technical Report September 2007- August 2009	
		Sponsoring Agency Code:	
15. Supplementary Notes: This study was conducted in cooperation with the Texas Department of Transportation and the Federal Highway Administration.			
16. Abstract: This study explores culvert load rating practices and procedures as applied to TxDOT's archive of 1477 culvert designs and their inventory of more than 13,000 in-service reinforced concrete box culverts. The problem is that when older culverts are load-rated based on current AASHTO policy, many competent, serviceable culverts are shown to be deficient, requiring load posting, retrofit or replacement. A disconnect exists between culvert structural analysis practices and actual culvert performance. To address this challenge, the research focused on development of a clear, repeatable and reliable procedure for TxDOT engineers and their consultants to use for load rating culverts in the TxDOT roadway system. Articulated in TxDOT's Culvert Rating Guide, the new load rating procedure uses <i>three increasingly-sophisticated analysis approaches, ranging from a direct stiffness frame model to a production-oriented finite element model which accounts for soil-structure interaction.</i> Validation of the Culvert Rating Guide involved three major tasks. First, the researchers load-rated a statistically representative sample of 100 of TxDOT's culvert designs. Second, a parametric study was performed to evaluate six independent variables associated with culvert load rating. Third, instrumented load tests on three in-service culverts were conducted to compare measured demands with predicted values. This work showed that the analytical methods in the Culvert Rating Guide produce conservative load ratings yet still allow for reduction in excess over-conservatism in the load rating process.			
17. Key Words load rating, culvert, soil-structure interaction		18. Distribution Statement No restrictions. This document is available to the public through the National Technical Information Service, Springfield, Virginia 22161 <a href="http://www.ntis.gov">www.ntis.gov</a>	
Security Classif. (of this report) Unclassified	20. Security Classif. (of this page) Unclassified	No. of Pages 310	22. Price



Evaluating Existing Culverts for Load Capacity Allowing for Soil Structure Interaction

by

William D. Lawson, P.E., Ph.D.

Timothy A. Wood, MSCE

Charles D. Newhouse, P.E., Ph.D.

Priyantha W. Jayawickrama, Ph.D.

Report Number

0-5849

Conducted for

Texas Department of Transportation

by the

Center for Multidisciplinary Research in Transportation

## **AUTHOR'S DISCLAIMER**

The contents of this report reflect the views of the authors who are responsible for the facts and the accuracy of the data presented herein. The contents do not necessarily reflect the official view of policies of the Texas Department of Transportation or the Federal Highway Administration. This report does not constitute a standard, specification, or regulation.

### **1. PATENT DISCLAIMER**

There was no invention or discovery conceived or first actually reduced to practice in the course of or under this contract, including any art, method, process, machine, manufacture, design or composition of matter, or any new useful improvement thereof, or any variety of plant which is or may be patentable under the patent laws of the United States of America or any foreign country.

### **2. ENGINEERING DISCLAIMER**

Not intended for construction, bidding, or permit purposes.

### **3. TRADE NAMES AND MANUFACTURERS' NAMES**

The United States Government and the State of Texas do not endorse products or manufacturers. Trade or manufacturers' names appear herein solely because they are considered essential to the object of this report.

Prepared in cooperation with the Texas Department of Transportation and the U.S. Department of Transportation, Federal Highway Administration.

## TABLE OF CONTENTS

Author’s Disclaimer.....	iv
1. Patent Disclaimer.....	iv
2. Engineering disclaimer.....	iv
3. Trade Names and Manufacturers’ Names.....	iv
Table of Contents.....	v
List of Figures.....	xii
List of Tables.....	xvi
List of Appendix Tables.....	xviii
List of Equations.....	xix
1. Introduction.....	1
1. The Research Problem.....	1
2. The Culvert Load Rating Equation.....	1
3. Culvert Load Rating Practices at TxDOT.....	3
4. Modified Research Direction – Development of a TxDOT <i>Culvert Rating Guide</i> .....	5
5. Research Focus: Validation of the <i>Culvert Rating Guide</i> .....	6
6. Organization of this Research Report.....	7
2. Culvert Load Rating Literature Review.....	9
1. Overview.....	9
2. Academic Literature.....	9
1. Box Culvert Definitions.....	9
2. Soil Loads.....	11
3. Vehicle Loads.....	14
3. Culvert Analysis Tools.....	15
1. Frame Models.....	15
2. Finite Element Models.....	16
4. AASHTO Policy Guidance.....	17
5. State Department of Transportation Survey.....	18
1. Introduction.....	18
2. State DOT Contacts.....	18
3. Interview Summaries.....	20
4. Results from the State DOT Survey.....	31

5.	Conclusions.....	32
6.	TxDOT District Survey .....	33
1.	Purpose.....	33
2.	District Notes .....	33
3.	Summary .....	35
7.	Conclusions .....	36
3.	Development of the Culvert Rating Guide .....	37
1.	Overview .....	37
2.	A Brief Summary of the Culvert Load Rating Process .....	38
3.	Primary Development Goal: Reliability .....	42
1.	Repeatability .....	42
2.	Capacity Calculation Approach .....	42
3.	Model Input Variables .....	42
4.	Model Sophistication .....	43
5.	Reliability Further Discussed.....	44
4.	Selection of Analytical Models .....	46
1.	Analytical Models and Programs for Determining Demand .....	46
2.	Value Analysis of Models.....	53
5.	Development of Level 1 Analysis: Two-Dimensional, Simply-Supported Structural Frame Model .....	58
1.	Model Construction.....	58
2.	Loads .....	58
3.	Analytical Program – CULV-5.....	60
6.	Development of Level 2 Analysis: Two Dimensional Structural Frame Model with Soil Springs .....	60
7.	Development of Level 3 Analysis: Two Dimensional Finite Element Soil- Structure Interaction Model.....	61
1.	Live Load Distribution.....	61
2.	Production Load Rating Considerations .....	63
3.	A Simple Beam Model Comparison Between CANDE and RISA .....	65
4.	Full Culvert Model Comparison Between CANDE and RISA .....	68
5.	RISA-2D as the Level 3 Analysis Program of Choice .....	70
8.	Commentary on the Culvert Rating Guide .....	71
1.	Chapter I: Introduction.....	71
2.	Chapter II: Policy Requirements .....	71



3.	Chapter III: Culvert Load Rating Procedure.....	72
4.	Chapter IV: Culvert Details .....	72
5.	Chapter V: Culvert Capacity Calculations .....	73
6.	Chapter VI: Analytical Modeling for Demand Loads .....	73
7.	Chapter VII: The General Analytical Model for Culvert Load Rating.....	74
8.	Chapter VIII: Limitations .....	74
9.	Validation of the Culvert Rating Guide.....	75
4.	Load Rating 100 TxDOT Culvert Designs .....	78
1.	Overview .....	78
2.	Method.....	79
1.	Sample of 100 Representative Culvert Designs.....	79
2.	Application of Load Rating Method to Domains .....	87
3.	Load Rating Results for 100 Culvert Designs .....	88
1.	Operational Statement and Hypotheses .....	88
2.	Presentation of the Research Findings .....	88
4.	1938 Era Results.....	91
1.	Undifferentiated Inventory Ratings .....	91
2.	Identification of Statistically-Significant Culvert Variables.....	93
3.	Differentiated Inventory Ratings by Significant Culvert Variables .....	94
4.	Controlling Failure Mode .....	96
5.	Controlling Critical Section .....	97
5.	1946 Era Results.....	99
1.	Undifferentiated Inventory Ratings .....	99
2.	Identification of Statistically-Significant Culvert Variables.....	100
3.	Differentiated Inventory Ratings by Significant Culvert Variables .....	101
4.	Controlling Failure Mode .....	103
5.	Controlling Critical Section .....	103
6.	1958 Era Structural Grade Steel (36 ksi).....	105
1.	Undifferentiated Inventory Ratings .....	105
2.	Identification of Statistically-Significant Culvert Variables.....	106
3.	Differentiated Inventory Ratings by Significant Culvert Variables .....	107
4.	Controlling Failure Mode .....	109
5.	Controlling Critical Section .....	109
7.	1958 Era Grade 60 steel (60 ksi) .....	111

1.	Undifferentiated Inventory Ratings .....	111
2.	Identification of Statistically-Significant Culvert Variables.....	112
3.	Differentiated Inventory Ratings by Significant Culvert Variables .....	113
4.	Controlling Failure Mode .....	114
5.	Controlling Critical Section .....	115
8.	2003 Era.....	117
1.	Undifferentiated Inventory Ratings .....	117
2.	Identification of Statistically-Significant Culvert Variables.....	118
3.	Differentiated Inventory Ratings by Significant Culvert Variables .....	119
4.	Controlling Failure Mode .....	120
5.	Controlling Critical Section .....	121
9.	Discussion.....	123
1.	Evaluation of Hypotheses .....	123
2.	Evaluations of Failure Modes.....	128
3.	Evaluation of Controlling Critical Sections.....	129
10.	Conclusions .....	131
1.	Reliability and Modeling Sophistication .....	131
2.	Principle Findings .....	131
3.	Limitations of Research .....	132
5.	Parametric Analysis of Six Culvert Variables .....	133
1.	Overview .....	133
2.	Sample Culvert Designs .....	134
3.	Results .....	135
1.	Modulus of Subgrade Reaction, $k$ .....	135
2.	Poisson's Ratio.....	140
3.	Multibarrel Effects .....	143
4.	Lateral Earth Pressure, LEP .....	147
5.	Depth of Fill.....	157
4.	Conclusions .....	164
6.	Instrumented Load Tests on Three In-service Culverts.....	166
1.	Overview .....	166
1.	Purpose and Scope .....	166
2.	Selection of Culverts for Instrumentation and Load Testing.....	166
2.	Load Test Design.....	167

1.	Load Rating Equation .....	167
2.	Measuring Live Load Demands – Instrumentation Design .....	168
3.	Application of Live Load – Field Test Procedure .....	168
4.	Predictive Analyses – Modeling the Load-Culvert-Soil System .....	170
5.	Obtaining Test Parameters.....	171
3.	Geotechnical Explorations at the Culvert Sites .....	172
1.	Description.....	172
2.	Field Drilling and Sampling.....	172
3.	Laboratory Testing.....	172
4.	Falling Weight Deflectometer Testing.....	172
5.	The Subsurface Profiles for Each Culvert Site .....	173
6.	Determination of Modulus of Subgrade Reaction Parameters .....	173
7.	Determination of Soil Modulus Parameters.....	174
4.	The Shallowater Culvert Instrumented Load Test.....	179
1.	Culvert Condition.....	179
2.	Summary of Parameters .....	180
3.	Instrumentation Plan .....	181
4.	Results for Shallowater Culvert with 2’ of Fill.....	182
5.	Results for Shallowater Culvert with 4’ of Fill.....	193
5.	The Plainview Culvert Instrumented Load Test.....	201
1.	Culvert Condition.....	201
2.	Summary of Parameters .....	202
3.	Instrumentation Plan .....	203
4.	Load Rating.....	204
5.	Live Load Moment – Predicted and Measured.....	205
6.	Dead Load Moment – Predicted .....	206
7.	Live Load “Goodness” .....	207
8.	Load Rating “Goodness” .....	208
9.	Critical Section Analysis.....	208
10.	Deflections .....	211
11.	Summary of Findings for the Plainview Culvert .....	212
6.	The Tulia Culvert Instrumented Load Test .....	213
1.	Culvert Condition.....	213
2.	Summary of Parameters .....	214

3.	Instrumentation Plan .....	215
4.	Load Rating.....	216
5.	Live Load Moment – Predicted and Measured.....	217
6.	Dead Load Moment – Predicted .....	218
7.	Live Load “Goodness” .....	219
8.	Load Rating “Goodness” .....	220
9.	Critical Section Analysis.....	220
10.	Deflections .....	222
11.	Summary of Findings for the Tulia Culvert.....	222
7.	Limited Dead Load Investigation .....	223
1.	Dead Load Moment – Predicted and Measured.....	223
2.	Dead Load “Goodness” .....	224
3.	Critical Section Analysis.....	224
4.	Deflections .....	227
5.	Summary of Findings for the Limited Dead Load Investigation.....	228
8.	Summary and Conclusions .....	229
7.	Conclusions and Research Limitations.....	230
1.	Conclusions .....	230
1.	Evaluation of TxDOT’s Culvert Load Rating Practices and Procedures .....	230
2.	Development of the Culvert Rating Guide .....	230
3.	Evaluation of TxDOT Culvert Designs and Analysis Methods.....	230
4.	Parametric Analysis .....	231
5.	Instrumented Load Tests on Three In-Service Culverts .....	231
2.	Limitations of Research.....	232
1.	Culvert Type .....	232
2.	Culvert Drainage Condition.....	232
3.	Soil Elastic Modulus.....	232
4.	Depth of Fill.....	232
5.	Live Load Demand Measurements .....	232
6.	Dead Load Demand Measurements .....	233
3.	Recommendations .....	233
8.	Bibliography .....	235
	Appendix A 1938 Era Load Ratings.....	241
	Appendix B 1946 Era Load Ratings.....	245

Appendix C 1958 Era 36ksi Steel Load Ratings .....	248
Appendix D 1958 Era 60ksi Steel Load Ratings .....	255
Appendix E 2003 Era Load Ratings .....	262
Appendix F Soil Boring Logs .....	266
Appendix G FWD Data .....	288
Appendix H Maximum and Minimum Strains From Load Testing .....	297

## LIST OF FIGURES

Figure 2.1. Embankment culvert.....	9
Figure 2.2. Trench culvert.....	10
Figure 2.3. Imperfect trench culvert .....	10
Figure 2.4. Negative soil arching.....	11
Figure 2.5. Postive soil arching.....	12
Figure 2.6. Soil pressure distributions due to culvert deformation.....	13
Figure 2.7. Culvert deformation due to lateral load only.....	13
Figure 3.1. Load Posting Guidelines.....	39
Figure 3.2. Flow chart depicting the TxDOT culvert load rating process.....	40
Figure 3.3. Prepackaged, two-dimensional culvert models loading diagram .....	47
Figure 3.4. General, two-dimensional, linear-elastic structural frame models loading diagram.....	48
Figure 3.5. General, two-dimensional, linear-elastic soil-structure interaction models loading.....	50
Figure 3.6. Two dimensional Frame Load Geometry.....	59
Figure 3.7. Two dimensional frame analysis comparisons of live loads.....	59
Figure 3.8. Two dimensional finite element AASHTO LRFD live load geometry.....	62
Figure 3.9. Two-dimensional FEA Comparisons of Live Loads.....	63
Figure 3.10. Demands from simple beam model comparison.....	67
Figure 3.11. Load rating Comparison of full scale culvert.....	68
Figure 3.12. Moment rating of full scale culvert .....	69
Figure 4.1. TxDOT's AS-BUILT Culvert Population.....	79
Figure 4.2. Culvert designs vs built vs sample by design era.....	80
Figure 4.3. Distribution of the number of spans for designs, built and sample populations ..	83
Figure 4.4. Distribution of the length of spans for designs, built and sample populations....	84
Figure 4.5. Distribution of box heights for designs and sample populations .....	85
Figure 4.6. Distribution of maximum depth of fill for designs and sample populations.....	86
Figure 4.7. Moment critical sections for culverts without haunches.....	90
Figure 4.8. 1938 era inventory ratings: undifferentiated .....	91
Figure 4.9. 1938 era statistical analysis for significant independent variables.....	93
Figure 4.10. 1938 era inventory ratings: direct traffic .....	94
Figure 4.11. 1938 era inventory ratings: 3' and 4' of fill.....	95
Figure 4.12. 1938 era inventory ratings: 6' of fill .....	95
Figure 4.13. 1938 era inventory ratings: 8' to 18' of fill .....	96
Figure 4.14. 1938 era controlling failure modes.....	96
Figure 4.15. 1938 era controLling critical sections: 0 to 6' of fill .....	97
Figure 4.16. 1938 era controlLing critical sections: 8' to 18' of fill.....	98
Figure 4.17. 1946 era inventory ratings: undifferentiated .....	99

Figure 4.18. 1946 era statistical analysis for significant independent variables.....	100
Figure 4.19. 1946 era inventory ratings: MBC-3.....	101
Figure 4.20. 1946 era inventory ratings: MC10-3-45.....	102
Figure 4.21. 1946 era inventory ratings: FM-MBC-3-26.....	102
Figure 4.22. 1946 era controlling failure modes.....	103
Figure 4.23. 1946 era controlling critical sections: MBC-3.....	103
Figure 4.24. 1946 era controlling critical sections: MC-10-3-45.....	104
Figure 4.25. 1946 era controlling critical sections: FM-MBC-3-26.....	104
Figure 4.26. 1958 era 36ksi steel inventory ratings: undifferentiated.....	105
Figure 4.27. 1958 era 36ksi steel statistical analysis for significant independent variables.....	106
Figure 4.28. 1958 era 36ksi steel inventory ratings: 2' of fill.....	107
Figure 4.29. 1958 era 36ksi steel inventory ratings: 4' of fill.....	108
Figure 4.30. 1958 era 36ksi steel inventory rating: 6' of fill.....	108
Figure 4.31. 1958 era 36ksi steel controlling failure modes.....	109
Figure 4.32. 1958 era 36ksi steel controlling critical sections: 2' of fill.....	109
Figure 4.33. 1958 era 36ksi steel controlling critical sections: 4' of fill.....	110
Figure 4.34. 1958 era 36ksi steel controlling critical sections: 6' of fill.....	110
Figure 4.35. 1958 era 60ksi steel inventory ratings: undifferentiated.....	111
Figure 4.36. 1958 era 60ksi steel statistical analysis for significant independent variables.....	112
Figure 4.37. 1958 era 60ksi steel inventory ratings: 2' of fill.....	113
Figure 4.38. 1958 era 60ksi steel inventory rating: 4' of fill.....	113
Figure 4.39. 1958 era 60ksi steel inventory ratings: 6' of fill.....	114
Figure 4.40. 1958 era 60ksi steel controlling failure modes.....	114
Figure 4.41. 1958 era 60ksi steel controlling critical sections: 2' of fill.....	115
Figure 4.42. 1958 era 60ksi steel controlling critical sections: 4' of fill.....	115
Figure 4.43. 1958 era 60ksi steel controlling critical sections: 6' of fill.....	116
Figure 4.44. 2003 era inventory ratings: undifferentiated.....	117
Figure 4.45. 2003 era statistical analysis for significant independent variables.....	118
Figure 4.46. 2003 era inventory ratings: 7' to 16' of fill.....	119
Figure 4.47. 2003 era inventory ratings: 20' of fill.....	119
Figure 4.48. 2003 era inventory ratings: 23' of fill.....	120
Figure 4.49. 2003 era controlling failure mode.....	120
Figure 4.50. 2003 era controlling critical sections: 7' to 16' of fill.....	121
Figure 4.51. 2003 era controlling critical sections: 20' of fill.....	121
Figure 4.52. 2003 era controlling critical sections: 23' of fill.....	122
Figure 5.1. Modulus of Subgrade Reaction vs. the Inventory Rating for Seven Representative Culvert Designs.....	137
Figure 5.2. Poisson's Ratio vs. the Inventory Rating for Seven Representative Culvert Designs.....	142

Figure 5.3. Number of Barrels vs. the Inventory Rating for Seven Representative Culvert Designs.....	146
Figure 5.4. Lateral Earth Pressure vs. the Inventory Rating for Seven Representative Culvert Designs using CULV-5.....	150
Figure 5.5. Lateral Earth Pressure vs. Inventory Rating for Seven Representative Culvert Designs using RISA-2D.Modulus of Elasticity, E .....	151
Figure 5.6. Modulus of Elasticity vs. the Inventory Rating for Seven Representative Culvert Designs.....	156
Figure 5.7. Inventory Rating vs. Depth of Fill for MC-7-16 4 7x4w16. ....	160
Figure 5.8. Inventory Rating vs. Depth of Fill for MC-10-20 5 10x10w20. ....	160
Figure 5.9. Inventory Rating vs. Depth of Fill for MC7-1 3 7x6w2.....	161
Figure 5.10. Inventory Rating vs. Depth of Fill for MC9-2 2 9x9w4.....	161
Figure 5.11. Inventory Rating vs. Depth of Fill for MC6-2 6 6x3w6.....	161
Figure 5.12. Inventory Rating vs. Depth of Fill for MBC-5-34 5 9x8w0.....	162
Figure 5.13. Inventory Rating vs. Depth of Fill for MBC1-44-F 2 5x4w6. ....	162
Figure 6.1. Critical sections .....	168
Figure 6.2. Gage line consisting of two foot grid marks to determining truck positions. ....	169
Figure 6.3. Live load configurations: a) truck straddling gage line b) wheel on gage line c) Two trucks straddling gage line.....	169
Figure 6.4. Idealized soil profile and raw field and laboratory soil strength data for the three culvert sites. ....	176
Figure 6.5. Idealized soil profile and derived modulus of subgrade reaction values for the three culvert sites. ....	177
Figure 6.6. Idealized soil profile and derived elastic modulus values for the three culvert sites. ....	178
Figure 6.7. Shallowater location. ....	179
Figure 6.8. Shallowater instrumentation plan.....	181
Figure 6.9. Load rating for Shallowater culvert: 2' of fill .....	182
Figure 6.10. Live load moments predicted and measured for Shallowater culvert: 2' of fill.....	183
Figure 6.11. Dead load predicted for Shallowater culvert: 2' of fill.....	184
Figure 6.12. Live load goodness plot for Shallowater culvert: 2' of fill .....	186
Figure 6.13. Load rating goodness plot for Shallowater culvert: 2' of fill .....	188
Figure 6.14. Measured deflections in millimeters for the Shallowater culvert: 2' of fill .....	191
Figure 6.15. Load rating for Shallowater culvert: 4' of fill .....	193
Figure 6.16. Live load moments predicted and measured for Shallowater culvert: 4' of fill. .....	194
Figure 6.17. Dead load predicted for Shallowater culvert: 4' of fill.....	195
Figure 6.18. Live load goodness plot for Shallowater culvert: 4' of fill .....	196
Figure 6.19. Load rating goodness plot for Shallowater culvert: 4' of fill .....	197



Figure 6.20. Measured deflections in millimeters for the Shallowater culvert: 4' of fill .....	199
Figure 6.21. Plainview location. ....	201
Figure 6.22. Plainview instrumentation plan. ....	203
Figure 6.23. Load rating for Plainview culvert: 3.5' of fill .....	204
Figure 6.24. Live load moments predicted and measured for Plainview culvert:3.5' fill. ...	205
Figure 6.25. Dead load predicted for Plainview culvert: 3.5' of fill.....	206
Figure 6.26. Live load goodness plot for Plainview culvert: 3.5' of fill.....	207
Figure 6.27. Load rating goodness plot for Plainview culvert: 3.5' of fill .....	208
Figure 6.28. Measured deflections in millimeters for the Plainview culvert: 3.5' of fill .....	211
Figure 6.29. Tulia location.....	213
Figure 6.30. Tulia instrumentation plan.....	215
Figure 6.31. Load rating for Tulia culvert: 1.5' of fill.....	216
Figure 6.32. Live load moments predicted and measured for Tulia culvert: 1.5' of fill.....	217
Figure 6.33. Dead load predicted for Tulia culvert: 1.5' of fill. ....	218
Figure 6.34. Live load goodness plot for Tulia culvert: 1.5' of fill .....	219
Figure 6.35. Load rating goodness plot for Tulia culvert: 1.5' of fill.....	220
Figure 6.36. Measured deflections in millimeters for the Tulia culvert: 1.5' of fill.....	222
Figure 6.37. The change in dead load moment, predicted and measured, for the Shallowater culvert from 2' to 4' of fill. ....	223
Figure 6.38. Change in dead load goodness for Shallowater culvert from 2' to 4' of fill. ....	224
Figure 6.39. Measured deflections in millimeters for Shallowater culvert from 2' to 4' fill. ....	227

## LIST OF TABLES

Table 1.1. Documented design/rating considerations from codes, policy and TxDOT examples. ....	3
Table 2.1. State DOT response .....	19
Table 2.2. Load types.....	31
Table 2.3. Load application .....	31
Table 2.4. Analytical programs.....	31
Table 3.1. Summary of models.....	46
Table 3.2. Summary of culvert applicable models .....	52
Table 3.3. Qualitative Evaluation of Model sophistication and reliability .....	53
Table 3.4. Qualitative Evaluation of Model input variables.....	54
Table 3.5. Qualitative Evaluation of ease of model generation.....	55
Table 3.6. Qualitative Evaluation of Model load rating suitability .....	56
Table 3.7. Summary of Qualitative Evaluation of Models for production load rating.....	57
Table 4.1. Evaluation of hypotheses by era.....	123
Table 4.2. Evaluation of hypotheses for low fill culverts.....	124
Table 4.3. Evaluation of hypotheses for medium fill culverts.....	125
Table 4.4. Evaluation of hypotheses for high fill culverts.....	126
Table 4.5. Prominent controlling critical sections.....	129
Table 5.1. Parametric Analysis Test Matrix .....	133
Table 5.2. Parametric Sample .....	134
Table 5.3. Percent Difference in Inventory Ratings. ....	135
Table 5.4. The Load Rating for 7 Representative Culvert Designs with Three Varying Modulus of Subgrade Reaction, k (psi). ....	136
Table 5.5. Number of Culvert Designs Out of a Sample of 100 Representative Designs which Meet Specific Criteria for the Maximum Percent Difference in the Inventory Rating. ....	139
Table 5.6. Percent Difference in Inventory Ratings. ....	140
Table 5.7. The Load Rating for 7 Representative Culvert Designs with Three Poisson's Ratios, $\nu$ . ....	141
Table 5.8. Percent difference in Inventory Ratings. ....	143
Table 5.9. The Load Rating for 7 Representative Culvert Designs with Increasing Number of Barrels. ....	145
Table 5.10. Change in Inventory Rating and Percent Difference in Inventory Rating.....	147
Table 5.11. The Load Rating for 7 Representative Culvert Designs with Increasing Lateral Earth Pressure. ....	149
Table 5.12. Required confidence for modulus of elasticity, E.....	153
Table 5.13. The Load Rating for 7 Representative Culvert Designs with Increasing Modulus of Elasticity.....	155

Table 5.14. The Load Rating for 7 Representative Culvert Designs with Increasing Depth of Fill.....	158
Table 5.15. Summary of Parametric Study Conclusions.....	164
Table 6.1. Live load predicted to actual ratio thresholds.....	185
Table 6.2. Operating rating goodness thresholds.....	187
Table 6.3. Live load demand problem critical sections for Shallowater culvert: 2' of fill...	190
Table 6.4. Operating rating problem critical sections for Shallowater culvert: 2' of fill.....	190
Table 6.5. Live load demand problem critical sections for Shallowater culvert: 4' of fill...	198
Table 6.6. Operating rating problem critical sections for Shallowater culvert: 4' of fill.....	198
Table 6.7. Live load demand problem critical sections for Plainview culvert: 3.5' of fill...	210
Table 6.8. Operating rating problem critical sections for Plainview culvert: 3.5' of fill.....	210
Table 6.9. Live load demand problem critical sections for Tulia culvert: 1.5' of fill.....	221
Table 6.10. Operating rating problem critical sections for Tulia culvert: 1.5' of fill.....	221
Table 6.11. Live load demand problem critical sections for the change in dead load in the Shallowater culvert from 2' to 4' of fill.....	225
Table 6.12. Operating rating problem critical sections for the change in dead load in the Shallowater culvert from 2' to 4' of fill.....	226

## LIST OF APPENDIX TABLES

Appendix Table 1. 1938 Era Sample Details and Culv-5 Load ratings.....	242
Appendix Table 2. 1938 era RISA-2D with springs load ratings.....	243
Appendix Table 3. 1938 era RISA-2D with LEFE load ratings.....	244
Appendix Table 4. 1946 era sample details and CULV-5 load ratings .....	246
Appendix Table 5. 1946 era RISA-2D with springs load ratings.....	246
Appendix Table 6. 1946 era RISA-2D with LEFE load ratings.....	247
Appendix Table 7. 1958 era 36ksi steel sample details and CULV-5 load ratings .....	249
Appendix Table 8. 1958 era 36ksi steel RISA-2D with springs load ratings.....	251
Appendix Table 9. 1958 era 36ksi steel RISA-2D with LEFE load ratings.....	253
Appendix Table 10. 1958 era 60ksi steel sample details and CULV-5 load ratings .....	256
Appendix Table 11. 1958 era 60ksi steel RISA-2D with springs load ratings.....	258
Appendix Table 12. 1958 era 60ksi steel RISA-2D with LEFE load ratings.....	260
Appendix Table 13. 2003 era sample details and CULV-5 load ratings .....	263
Appendix Table 14. 2003 era RISA-2D with springs load ratings.....	264
Appendix Table 15. 2003 era RISA-2D with LEFE load ratings.....	265
Appendix Table 16. Maximum and minimum strain ( $\mu\epsilon$ ) from Live Load test on Shallowater Culvert under 2' of fill.....	298
Appendix Table 17. Maximum and minimum strain ( $\mu\epsilon$ ) from Live Load test on Shallowater Culvert under 4' of fill.....	299
Appendix Table 18. strain ( $\mu\epsilon$ ) from Dead Load test on Shallowater Culvert do to a change in fill depth from 2' to 4'.....	300
Appendix Table 19. Maximum and minimum strain ( $\mu\epsilon$ ) from Live Load test on Plainview Culvert under 3.5' of fill.....	301
Appendix Table 20. Maximum and minimum strain ( $\mu\epsilon$ ) from Live Load test on Tulia Culvert under 1.5' of fill.....	302

## LIST OF EQUATIONS

Equation 1.1. The Rating Factor Equation from AASHTO MCEB 6.5.1.1-A.....	2
Equation 6.1. Curvature from inside and outside strain.....	170
Equation 6.2. Curvature from inside strain.....	170
Equation 6.3. Measured moment from strain.....	170



# **1. INTRODUCTION**

## **1. THE RESEARCH PROBLEM**

This report presents findings of a two-year research study of culvert load rating practices and procedures as applied to reinforced concrete box culverts that have been designed, built and maintained by the Texas Department of Transportation (TxDOT). The problem facing TxDOT is that when roads or rights-of-way are widened and/or raised, culverts which pass under them need to be reassessed for the extension and/or increased soil loads. These in-service culverts, which may have performed satisfactorily for many years, must be reanalyzed using current American Association of State Highway and Transportation Officials (AASHTO) methods. AASHTO has revised their culvert rating guidelines upward over the years to impose larger loads on buried structures, so this means that many older culverts, reanalyzed in the process of designing extensions, are seen as deficient, requiring either retrofit or replacement.

The problem, therefore, is that using today's culvert analysis methods on older culverts does not appear to accurately predict performance and structural capacity. A disconnect exists between current culvert structural analysis methods and actual culvert performance. This calls for research into the actual performance of the culvert-soil system which can be used to develop rational performance-based load rating guidelines. The objective is to satisfy current AASHTO policy yet not require unnecessary replacement or retrofit of older, competently-performing in-service culverts.

## **2. THE CULVERT LOAD RATING EQUATION**

The American Association of State Highway and Transportation Officials (AASHTO) defines "load rating" as the maximum truck tractor tonnage, expressed in terms of HS load designation, permitted across a culvert. The load rating is expressed in terms of two separate ratings – an Inventory Rating and an Operating Rating. The Inventory Rating (IR) is the maximum truck load that can safely utilize the culvert for an indefinite period of time (AASHTO, 2003; TxDOT, 2002). The Operating Rating (OR) is the absolute maximum permissible truck load that may use the culvert. Load ratings are based on the culvert's current condition and are determined through analysis and engineering judgment by comparing the culvert structure's capacity and dead load demand to live load demand.

The AASHTO *Manual for Condition Evaluation of Bridges (MCEB)* (AASHTO, 2003), and the AASHTO *Standard Specification for Highway Bridges (SSHB)* (AASHTO, 2002) provide governing policy for load rating culverts. The rating factor identified in Equation 1.1 is the mathematical expression of the culvert load rating process, and as such, is the focus of this research study. This rating factor is the ratio of the structural capacity minus the dead load demand to the live load demand.

EQUATION 1.1. THE RATING FACTOR EQUATION FROM AASHTO MCEB 6.5.1.1-A.

$$RF = \frac{C - A_1 D}{A_2 L (1 + I)}$$

where:  $RF$  = the rating factor  
 $C$  = the structural capacity of the member  
 $D$  = the dead load effect on the member  
 $L$  = the live load effect on the member  
 $I$  = the impact factor, IM from *SSHB* 3.8.2.3  
 $A_1$  = 1.3 = factor for dead loads, from *MCEB* 6.5.3  
 $A_2$  = 2.17 for Inventory Level = factor for live loads, from *MCEB* 6.5.3  
= 1.3 for Operating Level = factor for live loads, from *MCEB* 6.5.3

The load rating equation is deceptively simple; whereas, the load rating process is arguably complex. This becomes apparent when one considers that Equation 1.1 must be used to determine the rating factor for each critical section of the culvert (corners, midspans, top and bottom slabs, and interior and exterior walls), for each demand type (moment, shear and thrust), for different load envelopes (maximum, minimum) at each rating level (inventory and operating). The lowest inventory rating factor and the lowest operating rating factor control the load rating for the culvert.

The culvert load rating factors directly depend on how culvert capacity, dead load demands, and live load demands are established. Typical practice is to determine culvert capacity based on the details found on the original construction documents in combination with historical material property assumptions which are correlated by visual inspection of the culvert condition. The demand calculation process is accomplished through analytical modeling. Here, the AASHTO *SSHB* specifies a soil unit weight, equivalent fluid weight for lateral loads, and live load distributions through the soil, but it does not specify the type of demand model that should be used or specifically how to apply the loads to the model. This means that engineering decisions about modeling practices and procedures are necessary, and the assumptions, simplifications and mathematical structures of demand modeling tools can have a significant effect on the culvert load rating analysis.



### 3. CULVERT LOAD RATING PRACTICES AT TxDOT

The design and analysis of culverts at TxDOT has for many years incorporated TxDOT’s own in-house computer analysis program, CULV-5. CULV-5 is an MS-DOS program developed and distributed by TxDOT. The heart of the program is a two-dimensional direct stiffness frame model. Documentation supporting CULV-5 includes the Version 1.71 Readme file (TxDOT, 2004), Input Guide (TxDOT, 2003), and CULV5 – Concrete Box Analysis Program (TxDOT, 2003).

Upon initiation of the project, TxDOT engineers discussed their culvert load rating practices and procedures, including several load rating models. These included CULV-5 which was widely considered to be overly conservative. TxDOT engineers also noted their practice of ignoring bottom slab failures identified from CULV-5 load rating analyses. RISA frame models were mentioned as the preferred tool for TxDOT consultants. In general RISA frame models are considered to be slightly more accurate than CULV-5 models; however, it was noted that consultants refuse to ignore bottom slab failures regardless of the analysis tool.

Relative to articulation of their culvert load rating procedures, TxDOT engineers cited a DRAFT culvert rating guide developed for summer interns. To facilitate work on this research project, TechMRT requested of TxDOT their current culvert load rating procedure and some examples. In response, TxDOT provided three documents:

1. An example hand calculation with selected culvert detail sheets
2. An informal discussion of TxDOT’s culvert load rating procedure
3. The DRAFT culvert rating guide corresponding to a RISA-3D analytical model

The original research goals focused around modification of these culvert load rating procedures. However, as the TechMRT researchers began their work of reviewing these and other TxDOT documents that have to do with culvert load rating, four different sets of initial assumptions emerged. Table 1.1 summarizes these initial assumptions.

TABLE 1.1. DOCUMENTED DESIGN/RATING CONSIDERATIONS FROM CODES, POLICY AND TxDOT EXAMPLES.

Design Considerations	Current Aashto Manual	Pre-1948 Txdot Policy	Current Txdot Policy	Txdot Draft Culvert Rating Guide Example
(1)	(2)	(3)	(4)	(5)
Vertical Earth Pressure	120 pcf	(.7)(120pcf)	120 pcf	125 pcf
Horizontal Earth Pressure	60 or 30 pcf	30 pcf	40 pcf	41 pcf
Live Load	HS-20	12k wheel	16k wheel	HS-20
Live Load Distribution	1.75*D	Westeguard’s	1.7*D	1.75*D
Corner Moments	Full HEP	2’ surcharge	2’ surcharge	+ 2’ surcharge
Positive Moments	Half HEP	Full HEP	Full HEP	Full HEP
Shear	$\Phi = .85$	No HEP	Half HEP	Half HEP
Thrust	$\Phi = .9$		Slab Design	
Soil-Structure Interaction	Empirical			
Analytical Model		Moment Dist. By Hand		RISA-3D Plate Model

The first set of design parameters (Table 1.1, Column 2) depicts guidance from the current AASHTO *MCEB* (AASHTO, 2003) and *SSHB* (AASHTO, 2002). The AASHTO *MCEB* contains the load rating equations, the recommended material property assumptions and structural capacity equations. The AASHTO *SSHB* provides guidance for determining the dead and live loads used in the *MCEB*'s load rating equations. It provides details for determining vehicle live loads, culvert specific live load distribution, culvert specific soil related dead loads and reinforced cast-in-place box culvert empirical soil structure interaction equations.

The second set of parameters (Table 1.1, Column 3) is from the old TxDOT culvert load rating approach used before 1948. These values are published in the TxDOT *Bridge Design Manual* (TxDOT, 2001) which provides loading guidance and historical and recommended design parameters for reinforced concrete box culverts.

The third set of parameters (Table 1.1, Column 4) is from the current TxDOT approach as represented by the TxDOT *Bridge Design Manual*, the TxDOT *Bridge Inspection Manual* and the AASHTO *MCEB*. The TxDOT *Bridge Inspection Manual* (TxDOT, 2001) points out some limitations of historic design parameters, but generally directs load rating engineers to the AASHTO *MCEB* (AASHTO, 2003).

The fourth set of parameters (Table 1.1, Column 5) is from the TxDOT DRAFT culvert rating guide corresponding to the RISA 3D analytical model. The parameters embodied in this example differ from the parameters outlined in the AASHTO codes and TxDOT Manuals.

The existence of four culvert load rating approaches caused confusion relative to the load rating process. Selection of governing policy is a key issue, because a clear, reliable, and repeatable culvert load rating procedure needs to be solidly built on authoritative policy. A meeting of the Project Monitoring Committee was convened to resolve this issue. At that point a decision was made to base all work on current AASHTO policy requirements.

Another issue of concern relative to establishing a clear, repeatable procedure for culvert load rating is the diversity of analytical tools available to the culvert load rater. At the first project meeting, TxDOT's in-house culvert analysis program (CULV-5) and RISA frame models were discussed. In TxDOT's DRAFT culvert rating guide, a three dimensional plate model expressed in terms of RISA-3D was used. Other analytical models and computer programs are also available, each with their advantages and disadvantages. The problem is that each model will produce a different load rating. Practically this means that until a model or tool is specified in the load rating procedure, even given a consistent set of input parameters, no repeatable load rating can be determined.

The net outcome of this work was the realization that no one consistent, reliable procedure for load rating culverts existed within TxDOT. This called for a significant change in the research direction.

#### **4. MODIFIED RESEARCH DIRECTION – DEVELOPMENT OF A TxDOT *CULVERT RATING GUIDE***

In TechMRT's quest for the unified TxDOT culvert load rating procedure the following things became apparent:

1. TxDOT's current culvert load rating procedure was not well-articulated; that is, it was not clear, consistent with AASHTO policy, and repeatable.
2. TechMRT would not be able to modify the current TxDOT culvert load rating procedure until that procedure became well-articulated.

It was determined that TxDOT's needs would be better served by redirecting research effort toward the development, refinement, and validation of a new and improved TxDOT culvert rating procedure.

The new procedure should meet several requirements. The first is that it must be based upon authoritative AASHTO code. This resolves any policy issues for TxDOT's culvert rating process. Any engineer experienced in load rating should be able to understand how the assumptions and decisions in the procedure stem from the code.

A second requirement is that the procedure be conceptually clear. This helps the engineer to see and understand exactly what physical conditions are being modeled in the load-rating process. Distinguishing between the *model* for analysis (the conceptual plan) and the *method* of analysis (the computer program) is the issue here. Clarifying this relationship would help to reduce confusion and error.

Third, the new procedure should be general enough to be used with many analytical methods. The engineer should have the freedom to use the analysis method with which he/she is most comfortable. For example, if the engineer is not familiar with RISA-2D, it should be acceptable to use another frame analysis program.

Fourth, the new procedure should incorporate escalating levels of analytical rigor, the goal being to balance load rating effort with reliability of the findings. This is particularly important for production load rating of culverts. The first levels of analysis would be relatively simple, quick and easy to use, and built around a two-dimensional frame model or moment distribution. Higher level models would incorporate soil-structure interaction. The highest levels would allow for enhanced (project-specific) input values, and the use of a three-dimensional finite-element solution with soil-structure interaction. These highest levels would be considered research oriented rather than production oriented.

Finally, the new culvert rating procedure would need to be validated through application of the procedure to a diverse sample of TxDOT culvert designs, by parametric analyses which compare results among the different modeling approaches, and by field observation and testing. The culvert rating procedure should express a valid relationship between predictions based upon the analytical models and actual culvert stresses determined from in-service performance.

To reiterate, the focus for this project was redirected toward developing a new, improved culvert rating procedure that incorporates the following features:

1. It is based on authoritative AASHTO code
2. It is conceptually clear
3. It is generally applicable to many analytical methods
4. It incorporates escalating levels of analytical rigor
5. It is validated through research activities focusing on breadth of application, sensitivity to parameters, and correspondence with actual culvert performance

To satisfy these objectives, the research team developed and published TxDOT's *Culvert Rating Guide* (TxDOT, 2009). The *Culvert Rating Guide* first appeared in DRAFT form and went through multiple iterations of review and refinement. This work comprised the bulk of the first year of effort for this research study.

## **5. RESEARCH FOCUS: VALIDATION OF THE *CULVERT RATING GUIDE***

Having articulated TxDOT's recommended practices and procedures for culvert load rating in the *Culvert Rating Guide*, the second year of research effort was directed toward validating these practices and procedures. The approach for validating the culvert load rating practices and procedures in the *Culvert Rating Guide* involved three research thrusts.

First, the *Culvert Rating Guide* was applied to a statistically representative sample of 100 of TxDOT's 1477 unique culvert designs. Rating these 100 culvert designs provided assurance the *Culvert Rating Guide* could be used for the full population of TxDOT's culverts, and not just a few select cases.

Second, a parametric study was performed to evaluate six independent variables associated with culvert load rating. The parametric study explored the influence of each parameter on the inventory rating of the culvert for a set of seven culvert designs. This helped determine the sensitivity of the culvert rating process to the different variables.

Third, the research team instrumented and load tested three in-service culverts in the field. This work facilitated a comparison of measured demand moments to predicted values obtained through analytical modeling as per the *Culvert Rating Guide*.

Taken together, these three research tasks provided validation of the *Culvert Rating Guide* through breadth of application, sensitivity of expression, depth of correlation of the culvert rating practices and procedures relative to the full population of TxDOT's reinforced concrete box culverts.

## 6. ORGANIZATION OF THIS RESEARCH REPORT

This report is organized into seven chapters. Chapter 1 is this introduction which presents the research problem and the context for this study.

Chapter 2 presents a discussion of the literature on culvert load rating. This includes academic literature about various culvert rating issues, as well as results from a survey of culvert rating practices and procedures for the 50 State DOTs and the 25 TxDOT Districts.

Chapter 3 describes the development of the *Culvert Rating Guide*. This includes a brief summary of the culvert load rating process, a detailed discussion of several load rating considerations addressed during development of the *Culvert Rating Guide*, and a chapter-by-chapter commentary on the *Culvert Rating Guide*.

Chapter 4 represents a shift from development of the *Culvert Rating Guide* to its validation. This chapter presents results from load rating a statistically-representative sample of 100 TxDOT culvert designs. This includes a discussion of how TxDOT's culvert designs are stratified by design era, the operational research problem statement and hypotheses which define three different levels of analytical modeling, and the load rating results by era – the 1938 era, the 1946 era, the 1958 era, and the 2003 era. This chapter also includes a discussion of the results and a summary of conclusions for this research task.

The parametric study of six independent variables associated with culvert load rating is the topic of Chapter 5. The variables include modulus of subgrade reaction, Poisson's ratio, multibarrel effects, lateral earth pressures, soil modulus of elasticity, and depth of fill. The summary of conclusions for this chapter points out how culvert load rating is not very sensitive to the first four of these variables, but culvert load rating is sensitive to the last two.

Chapter 6 presents the findings from instrumented load tests on three in-service culverts. This includes a discussion of the load test design, geotechnical studies associated with the load testing, and presentation of the instrumented load test results by culvert site.

The report closes (Chapter 7) with a summary of key research findings and with recommendations both for additional research and for implementation.

This report includes three appendices. Appendix A through E presents data from load rating the 100 culverts in Chapter 4. Appendix F presents the geotechnical boring logs obtained from each culvert site in Chapter 6. Appendix G presents the falling weight deflectometer data obtained from each culvert site. Appendix H presents the maximum and minimum strain data collected during live load testing.



## 2. CULVERT LOAD RATING LITERATURE REVIEW

### 1. OVERVIEW

This chapter briefly summarizes conceptual information, loading issues, analytical modeling tools, and policy guidance associated with culvert load rating which are discussed in the academic literature. Also included is a summary of culvert load rating practices and procedures as determined based on interviews with representatives from the 50 State DOTs and the 25 TxDOT Districts. This information informed our evaluation of TxDOT's culvert load rating practices and procedures and provided insight about modeling and analysis issues encountered during development of the *Culvert Rating Guide*.

### 2. ACADEMIC LITERATURE

#### 1. *Box Culvert Definitions*

In order to better explain the findings from the academic literature survey, it is important to define several types of box culverts. Box culverts are differentiated by the type of installation. According to the literature there are three popular reinforced concrete box culvert installation procedures.

The first and most often modeled in early finite element analyses is the embankment culvert. These culverts are installed by placing the culvert on existing or built-up soil and then burying them beneath back fill. Figure 2.1 shows an embankment culvert. It is important to point out that the surrounding soil mass, even if well consolidated, is less stiff than the combined culvert and soil column portion. Therefore, the surrounding material will tend to settle more than the soil directly above the culvert.

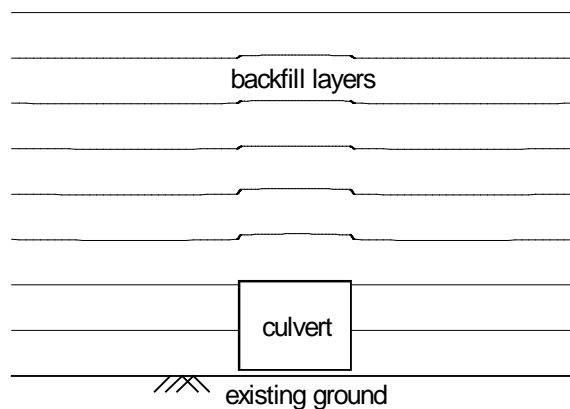

FIGURE 2.1. EMBANKMENT CULVERT

The second and most often constructed culvert is installed in a trench. Figure 2.2 illustrates the trench installation. In this situation the backfilled soil will tend to be less stiff than the surrounding in-situ soil and will experience more settlement than the in-situ soil.

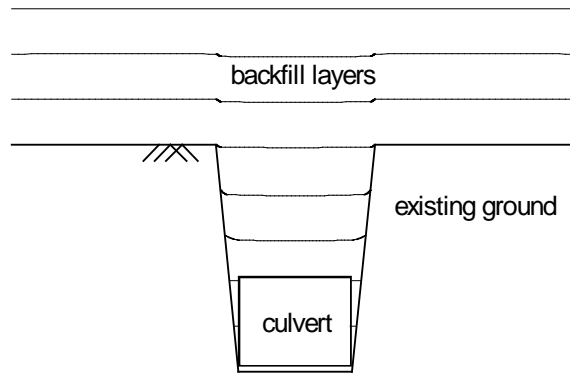

FIGURE 2.2. TRENCH CULVERT

The third and experimental method is called the imperfect trench method culvert. Figure 2.3 shows this culvert type. This culvert is installed by first placing the culvert on the in-place or built-up soils and backfilling around the culvert. Then a layer of compressible material such as polystyrene, straw or compressive soil is placed directly above the culvert. Then the rest of the material is backfilled to final grade and compacted. This installation causes the column of culvert, compressible material and backfill to be less stiff than the surrounding backfill. The corresponding relative settlement is similar to the trench culvert and shares the same load reduction characteristic (Kim & Yoo, 2005). These will be discussed in greater detail in the second section of this literature review.

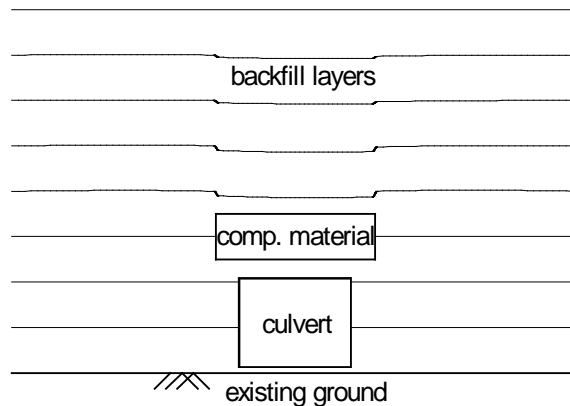

FIGURE 2.3. IMPERFECT TRENCH CULVERT



## 2. Soil Loads

Two primary actions determine the magnitude and distribution of soil loads on a culvert. The first is called soil arching, and the second is culvert deformation. In this discussion, it is important to keep the indeterminate nature of the soil structure interaction problem in mind. Most commonly-used design programs take into consideration the indeterminacy of the frame structure of box culverts; this is why matrix analysis methods are used so commonly to determine moments, thrust and shear. However, beyond just the structural indeterminacy, the loads are indeterminate in nature. Because soil has some strength on its own, it can carry a portion of its own weight or even some of the surrounding soil weight. Elastic theory has difficulty accounting for the non-linear, unpredictable nature of this behavior. This explains why there is so much interest in applying finite element methods to solve the soil-structure interaction problems.

One indeterminate effect on soil load is soil arching. Soil arching occurs when differential settlement occurs in soil. As one section of soil settles more than a neighboring section, shear stresses develop to resist the settlement. The application of soil arching to culverts is primarily dependent on the type of culvert installation.

In embankment installation culverts, soil arching creates a negative arching effect. As discussed in Box Culvert Definitions, the combined column of culvert and soil is stiffer than the surrounding soil. As the surrounding soil settles more than the soil above the culvert, shear planes develop along the interface. These shear forces transfer some of the neighboring soil weight onto the culvert. The net result is that the structure is required to carry the weight of the soil column as well as some of the surrounding soil weight. Figure 2.4 shows this effect. As the soil continues to settle over time the load will continue to increase. Some studies suggest that the increased load may be as much as twice the weight of the in-situ soil column. (Tadros, 1986; Yang, 1997; Yang, 1999)

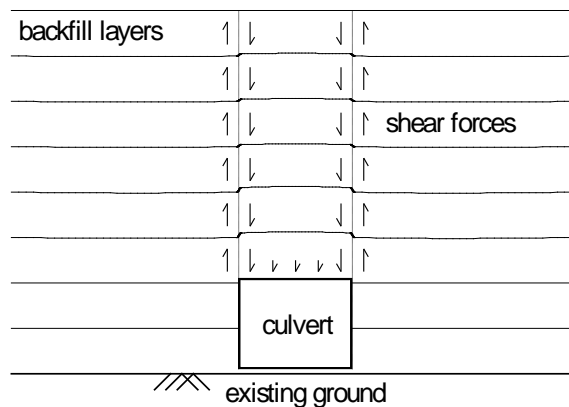

FIGURE 2.4. NEGATIVE SOIL ARCHING

In trench culverts and imperfect trench culverts, positive arching occurs. Here the culvert and soil column are less stiff and experience greater settlement than the surrounding soil. Therefore the shear stress and load changes are in the opposite direction. The resulting load reductions can be less than half the weight of the soil column. Figure 5 shows this effect. (Dasgupta & Sengupta, 1991; Dasgupta & Sengupta, 1991; Vaslestad, Johansen, & Holm, 1993)

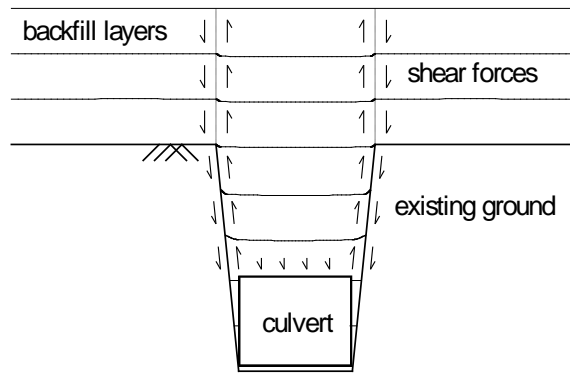

FIGURE 2.5. POSTIVE SOIL ARCHING

Some attempt has been made to take the increase in load into consideration for embankment installations. The earliest AASHO specification included a highly empirical equation for determining the increase in load (Gardner & Jeyapalan, 1982). These formulations were later developed and refined into soil-structure interaction factors by Spangler (Bennett, 2005). The Portland Cement Association developed an empirical design chart to determine the loads as well (PCA, 1975). Later AASHTO codes formalized another soil-structure interaction factor,  $F_e$ . However, field test research suggests this soil-structure interaction factor still underestimates the effective weight of structures (Bennett, 2005; Kim & Yoo, 2005; Tadros & Benak, 1989; Yang, 1999).

In trenched installations, the outlook is a little better. Research suggests that AASHTO, though still unconservative, may more closely match test results. Bennett suggests that the AASHTO specification, though unconservative, still meets the reliability demands of the new LRFD code (Bennett, 2005). In imperfect trench installations, though still fairly experimental and difficult to design, the actual loads may be far less than those predicted by AASHTO (Vaslestad, Johansen, & Holm, 1993).

The way the culvert deflects also affects the amount of load on the structure. This adds yet another level of indeterminacy to the soil-culvert system. One place that culvert deflections affect load is at the center of the top and bottom slabs. As load causes the culvert to deflect downward in the center of the span, the soil begins to transfer the load away from the center of the span to the outside of the culvert. This results in a decreased load in the center of the span and an increased load at the supports. Such culvert deformation helps reduce the moment in the top slab. The same deformation and moment reduction occurs in the bottom slab. Several papers indicated that the actual pressure distribution is parabolic instead of uniform (Dasgupta & Sengupta, 1991; Katona & Vites, 1982). At least one author indicated that the load redistribution might continue due to creep (Oswald, 1996). See Figure 2.6.

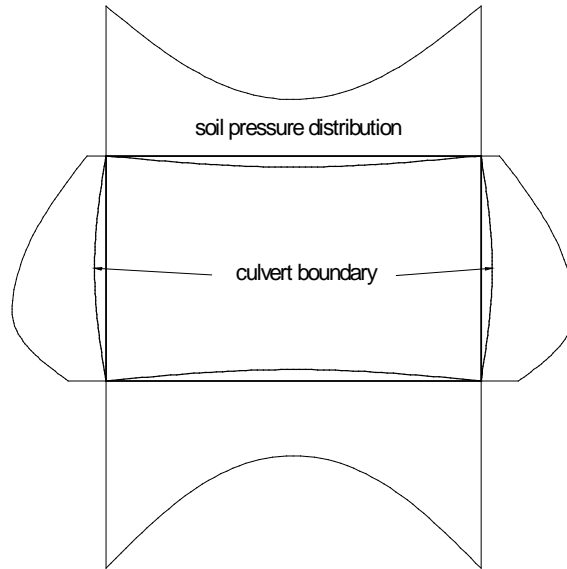

FIGURE 2.6. SOIL PRESSURE DISTRIBUTIONS DUE TO CULVERT DEFORMATION(DASGUPTA & SENGUPTA, 1991)

Deflection due to lateral loads may also affect loads elsewhere on the structure. Lateral deflection tends to cause the box culvert to deflect in an opposite manner and negate the deflections from the vertical pressure (see Figure 2.7). This effect causes another decrease in moment in the top and bottom slab (Awwad, 2000).

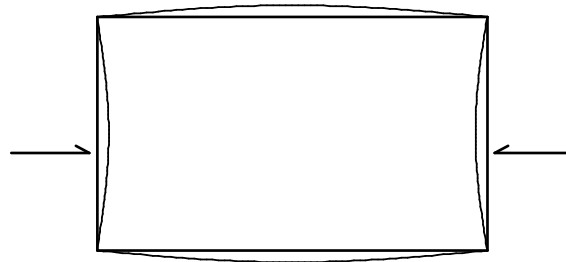

FIGURE 2.7. CULVERT DEFORMATION DUE TO LATERAL LOAD ONLY

This review of soil loads suggests several conclusions related to culvert load rating. First, in the case of embankment culverts, AASHTO specifications are already unconservative. It is doubtful that any analysis will allow for reduction of excessive overconservatism in load ratings for existing culverts designed by this method. For trench installed culverts, more accurate modeling of positive soil arching, culvert deflections, and creep considerations may allow for reduction of excessive overconservatism in load ratings. The analytical model used for predicting these effects must be capable of dealing with all the indeterminacies of the soil-structure system.

### 3. *Vehicle Loads*

This section explores the live load conditions and modeling that affect culvert load ratings. The earliest research in vehicle loads on culverts was done by Spangler, Manson and Winfrey in 1926. Their study indicated that the Boussinesq stress distribution for point loads represents the maximum load distributed to culverts from vehicle loads. Spangler finds it very interesting that Boussinesq equations for continuous materials model granular substances so well. Their testing also suggested that impact loads increased the loads by 50% to 100%.

AASHTO codes simplify the distribution of soil loads to the culvert by expanding the contact dimensions by 1.75 times the depth of fill for fill depths ranging from 2 ft to 8 ft. Below 2 ft, the culvert is treated as a direct traffic culvert with no load distribution. Above 8 ft, live load may be ignored. Several papers indicate that this approximation is safe and reasonable (Abdel-Karim, Tadros, & Benak, 1990; Tadros & Benak, 1989). The AASHTO LRFD design is far more conservative. It allows a spread of only  $1.15H$  in good soil cases and  $1H$  in all others. It also specifies an impact factor which varies with fill depth and ranges from 0.33 at 2 ft to 0 at 8ft (Rund & McGrath, 2000).

More recent studies indicate that the Boussinesq stress distribution, two dimensional finite element analysis, three-dimensional finite element analysis and field testing all correlate reasonably well. Seed and Raines provide an equivalent line load equation to determine the axle load for a two dimensional finite element analysis (Seed & Raines, 1988). Most of the studies approve of AASHTO's square area distribution as conservatively reflecting the load. They also agree that beyond 10 ft of fill the truck load becomes negligible compared to earth pressure loads (Abdel-Karim, Tadros, & Benak, 1990; Awwad, 2000; Tadros & Benak, 1989). One study suggested including the distributive effect of the road bed. In the case of flexible pavements (asphalt paving) the suggestion is just to treat the pavement as additional fill depth. For rigid pavement structures (concrete) the load can be distributed through the pavement according to Boussinesq's equations. Another option would be to develop an equivalent depth for rigid pavements (Abdel-Karim, Tadros, & Benak, 1990).

Possible methods for reduction of excessive overconservatism in load ratings include more accurate modeling of distribution of the applied loads through finite element analysis or Boussinesq's equations, and by considering the load-distribution effects of pavement stiffness.

### 3. CULVERT ANALYSIS TOOLS

#### 1. *Frame Models*

Several modeling programs are available to analyze culverts. The simplest of these are two dimensional frame models. Two dimensional frame models have many advantages. They are simple to construct with often fewer than a dozen nodes; some even construct the model automatically from a few culvert geometry properties. Their structural stiffness matrices are smaller and therefore require less computation time and introduce fewer errors. They can deal with the behavior of reinforced concrete by using beam elements with transformed moments of inertia. The beam elements themselves are built around a proven and well understood mechanics of materials model.

Several companies, Departments of Transportation, and academic institutions have developed design charts and computer programs built upon the AASHTO specification for the simplified design of culverts. All of these programs use the AASHTO specifications and some form of two dimensional frame analysis. The programs included the Portland Cement Association (PCA) design manual (PCA, 1975), the American Society for Testing and Materials (ASTM) C789, C850 and C1433 specifications (Garg, Abolmaali, & Fernandez, 2007), BOXCAR by the Federal Highway Administration (FHWA), SPIDA from the American Concrete Pipe Association (ACPA) (Tadros, 1986). Several Departments of Transportation have developed their own design programs including Virginia (Latona, Heger, & Bealey, 1973), Alabama (Lakmazaheri & Edwards, 1996) and Texas (TxDOT, 2003). Again none of these programs consider soil-structure interaction. Basically these programs make the structural design of culverts simpler and less time consuming. These programs are not sophisticated or precise enough for the refinement of the current load rating procedures.

Other programs are general structural programs. The most popular in common use are the RISA-2D and RISA-3D programs. Programs like RISA are built upon the same basic modeling principles as the culvert-specific programs listed above. The advantage to general structural programs over culvert-specific programs is their ability to model intermediate boundary conditions using springs. This allows the bottom slab to be supported more realistically. The slight disadvantage to a general structural program is the need to determine loads by hand and create the model manually.

Relative to TxDOT's approach to load-rating culverts, TxDOT engineers like to use their in-house culvert-specific program, CULV-5, for load rating culverts. CULV-5 is simple and easy to use. It takes culvert geometry inputs and produces design moments, shears, and thrusts. These can then be used to design appropriate culvert sections with adequate capacity. CULV-5 incorporates, at some level, all the appropriate code loading requirements including the live load distribution, and it is a terrific design tool. However, CULV-5 does have one significant drawback. It is generally overly conservative in how it applies live load. It determines the live load demands by developing influence lines for the structure. The influence lines are actually determined by not only applying the moving unit load to the top slab, but also by applying one-twentieth loads at twentieth points across the bottom slab. This results in overly conservative results, particularly in the bottom slab (TxDOT, 2003).

## *2. Finite Element Models*

Culvert load rating literature indicates that the finite element analysis (FEA) method offers superior capabilities for predicting culvert and soil-culvert behavior. Finite element codes allow for “modeling phenomena not described by the culvert specific codes” and for graphical investigations of the results (Duane, Robinson, & Moore, 1986). The most popular soil models can be integrated in the FEA code. Such models include linear elastic models, elasto-plastic with Mohr-Coulomb failure, soil hardening with stress dependent stiffness and Mohr-Coulomb failure, Hardin, Duncan, and bilinear. Duncan is the most popular (Kim & Yoo, 2005; Kitane & McGrath, 2006). Though it is clear that FEA is the analytical tool of choice for analyzing culvert structures, the particular implementation of FEA must be determined.

The number of general and soil-specific FEA programs available is impressive. Culvert analysis research has used SSTIPN (Gardner & Jeyapalan, 1982; Duane, Robinson, & Moore, 1986; Sharma & Hardcastle, 1993), REA (Roschke & Davis, 1986), STUDL (Frederick, 1988), FINLIN (Duane, Robinson, & Moore, 1986; Sharma & Hardcastle, 1993), NLSSIP (Sharma & Hardcastle, 1993), SUPERB (Duane, Robinson, & Moore, 1986), MARC (Duane, Robinson, & Moore, 1986), ISBILD (Kim & Yoo, 2005), Plaxis (Kitane & McGrath, 2006), ABAQUS (Yang, 1997; Kim & Yoo, 2005; Kitane & McGrath, 2006) and CANDE (Katona & McGrath, 2007; Katona & Smith, 1976; Katona & Vittes, 1982; Katona M. G., 1976; Katona M. G., 1979)(Oswald, 1996; Kim & Yoo, 2005). Of all these, two FEA programs stand out from the rest.

ABAQUS has the distinct advantage of three dimensional modeling. It incorporates a general-purpose FEA code, but has been successfully programmed to incorporate soil models. ABAQUS’ well developed graphical interface makes the program easy to use and the results easy to interpret.

However, Culvert ANalysis and DEsign, or CANDE, appears to be the de facto standard for soil-culvert interaction analysis. It was commissioned by the FHWA and developed by Katona in 1976. Even from its earliest punch-card/FORTRAN versions, CANDE included a great deal of sophistication including three soil models, a crack conscious concrete model, and time dependent construction sequences. It has also been adapted by researchers to consider concrete creep and shrinkage and interface slippage. CANDE’s primary advantage is the amount of validation that has been done. Over the last 30 years test data has been compared to CANDE’s predictions and has showed error of around 10% for service loads and less than 1% for ultimate loads (Katona 1976). That degree of accuracy is within the normal tolerances for structural design and far better than expected for geotechnical engineering. The development of CANDE-2007 to allow for graphical output has only made the program more user-friendly.

#### 4. AASHTO POLICY GUIDANCE

The development of the American Association of State Highway and Transportation Officials' (AASHTO) provisions for culvert design actually begins with the American Association of State Highway Officials' (AASHO) *Standard Specifications for Highway Bridges* (AASHO, 1949). In Article 3.2.2, AASHO defines the unit weight of “compacted sand, earth, gravel or ballast” as 120 pcf. It then proceeds to tell the designer exactly how this earth load is to be applied to culverts.

Per AASHO, earth pressures or load on culverts could be computed ordinarily as the weight of earth directly above the slab. In order to have the effect of increasing the allowable design dead load stresses 40 per cent more than allowed for live load, AASHO allowed the effective weight of earth backfill to be taken as 70 per cent of its actual weight (AASHO, 1949). This provision is the source of the culvert load rating problem currently experienced by TxDOT.

The very next paragraph in the AASHO code instructs the design engineer to use the principles of soil mechanics when designing rigid culverts. It then provides recommended equations for two classes of culvert installation: trench and embankment.

The only further code direction generally applicable to reinforced culvert design is the definition of the allowable stress. For concrete the allowable stress is one third of the compressive strength (AASHO, 1949).

In 1977, the 70% provision disappeared from the AASHTO *Bridge Specification* (Kim & Yoo, 2005). In 1983, the code still used the 120 pcf value for the vertical unit weight of soil, and it defined the effective horizontal unit weight as 30 pcf. The specific equations for determining the load were no longer provided though it was generally expected that vertical soil loads would be calculated based on 100% of the soil unit weight.

The 1983 AASHTO code also prescribed a method for distributing the live load from an HS truck load through the cover soil. It instructed the design to increase the dimensions of the tire prints by  $1.75 H$  for covers of more than 2 ft of fill. When these areas overlap, the total load should be redistributed over the area defined by the outside boundaries. This increase in footprint reduced the live load pressure dramatically with depth. The code indicates that the live load can be ignored for cover depths of more than 8 ft. The live load assumptions are the consistent throughout latter revisions of the code.

In 1987, AASHTO released an interim report that updated the 1983 code in two ways. First, it increased the horizontal soil unit weight in some cases from 30 pcf to 60 pcf. The 1987 code is unclear about when these values should be used. The second update was the addition of a crack control stress limit.

In 1990, the AASHTO code received another update for reinforced concrete box culverts. This consisted of a revised equation for calculating the earth pressure on the structure which included a soil-structure interaction factor for both embankment installations and trench installations.

The inclusion of the soil-structure interaction factors was the first and only coded application of soil-structure interaction in reinforced concrete box culverts. This method for determining the soil pressure is used throughout the rest of the AASHTO *Standard Bridge Specifications*. Later editions increased the complexity of the crack control provision only.

AASHTO specifications suggest that for culverts with less than 2 ft of fill, the soil does very little to distribute the load and that the culvert should be designed as a direct slab. Several researchers have expressed concern about the inconsistencies that this assumption creates. Many authors have indicated that the AASHTO provisions greatly underestimate actual soil pressures (Abdel-Karim, Tadros, & Benak, 1990; Tadros, Benak, & Gilliland, 1989; Yang, 1999).

## **5. STATE DEPARTMENT OF TRANSPORTATION SURVEY**

### ***1. Introduction***

This research study included a survey of State Departments of Transportation (DOTs) in order to broaden our understanding of the research problem and to gain information about how other State DOTs address culvert load rating issues.

One primary focus of the State DOT survey was to identify other transportation agencies that were having problems similar to TxDOT relative to the load rating and evaluation of their existing concrete box culverts. The survey also explored how these agencies addressed this problem and what procedures they used to load rate their culverts.

Forty-nine out of the 50 State DOTs, excluding Texas, were contacted by phone. We obtained data from Texas directly. Of the 50 State DOTs, 39 DOTs responded via phone, in person, or by email, which is a 78% response rate.

### ***2. State DOT Contacts***

Contact information for each State DOT was obtained from the directory on each State DOT website. The target contact was generally found to reside within the bridge design or the bridge maintenance/inspection division. Once this person was contacted via phone they were given the choice as to whether they completed the questionnaire over the phone or through email.

Table 2.1 provides the response summary for all 50 states. It also identifies the type of response received including those states where no response was obtained. Totals show the number of states in each response category and the percentage relative to the total number of states contacted.



TABLE 2.1. STATE DOT RESPONSE

<i>State DOT</i>	<i>No Contact</i>	<i>Telephone Interview</i>	<i>Emailed Survey</i>	<i>Completed Survey</i>
Alabama		✓		✓
Alaska			✓	✓
Arizona			✓	✓
Arkansas			✓	✓
California			✓	✓
Colorado		✓		✓
Connecticut			✓	✓
Delaware			✓	✓
Florida			✓	✓
Georgia			✓	✓
Hawaii			✓	✓
Idaho			✓	
Illinois			✓	✓
Indiana			✓	✓
Iowa			✓	✓
Kansas			✓	✓
Kentucky			✓	
Louisiana			✓	✓
Maine	✓			
Maryland	✓			
Massachusetts	✓			
Michigan			✓	✓
Minnesota			✓	✓
Mississippi			✓	
Wyoming			✓	✓
Missouri			✓	✓
Montana			✓	✓
Nebraska			✓	✓
Nevada			✓	✓
New Hampshire			✓	✓
New Jersey			✓	✓
New Mexico			✓	✓
New York			✓	✓
North Carolina			✓	✓
North Dakota			✓	✓
Ohio			✓	✓
Oklahoma			✓	
Oregon			✓	✓
Pennsylvania			✓	
Rhode Island	✓			
South Carolina			✓	✓
South Dakota			✓	✓
Tennessee			✓	✓
Texas		✓		✓
Utah			✓	✓
Vermont	✓			
Virginia			✓	✓
Washington			✓	✓
West Virginia			✓	✓
Wisconsin	✓			
50 TOTAL (100%)	6 (12%)	3 (6%)	41 (82%)	39 (78%)

The formal questionnaire provided a general description of the research project including background information describing TxDOT's experiences relative to load-rating their in-service culverts. This provided a frame of reference for the respondent so that s/he could relate their answers to be as helpful as possible in our search for information. The survey inquired about State DOT culvert rating procedures, techniques and software used. If their culvert rating procedure accounted for soil-structure interaction, the survey requested specific information about this.

### **3. Interview Summaries**

This section summarizes the results of the email/phone interviews for each of the State DOT that responded to the research inquiry.

#### *1. Alabama*

- Uses HS20 loading
- Applies loads according to AASHTO specs.
- Does account for soil structure interaction
- Conducts lab testing for variable soil conditions
- Software is BRASS Culvert and GTSTRUDL
- They do not have a similar problem because their culverts are evaluated based on the process under which they were designed
- Have sponsored research for soil interaction for high fill culverts
- When the circumstance arises that neither software program provides an adequate response, they physically go to the culvert and attach strain gages to the culvert and run known load vehicles over the culvert to verify the load that the culvert can support.

#### *2. Alaska*

- Uses HS20 loading
- Load rates according to AASHTO specs 17<sup>th</sup> Edition, and applies dead loads as required per section 6.2 and live loads as required per section 6.4
- They make the assumption that the AASHTO methods account for soil-structure interaction
- No accounting for varying soil conditions
- Software used is RISA 3D
- Does not have a similar problem

#### *3. Arizona*

- Does not load rate or evaluate their existing culverts at this time

#### *4. Arkansas*

- Uses HS20 loading
- Load rates according to AASHTO specs, and applies dead loads as required per section 6.2 and live loads as required per section 6.4

- Accounts for soil-structure interaction in section 16.6.4.2 in AASHTO specs
- Software used is BRASS Culvert Version 2.2
- Does not have a similar problem

#### 5. *California*

- Uses HS20-44 loading
- The loads are applied to the culvert through an equivalent fluid weight system, with the application varying based on depth of fill over culvert
- Soil-structure interaction is accounted for in the equivalent fluid weight system
- Concrete box culverts are designed as “rigid” structures based on the equivalent fluid method above and therefore varying soil conditions are assumed to have no influence
- LRFD design is implemented by the CANDE-2007, SAP2000, and CTBC software
- Does not have a similar problem
- Does have a culvert evaluation procedure for culverts > 20 ft span
- Sponsored research includes: NCHRP 15-28: CANDE-2007
- NCHRP 15-29: Live load distribution thru soil

#### 6. *Colorado*

- Does not load rate or evaluate their existing culverts at this time

#### 7. *Connecticut*

- Uses HS20 loading
- If the culvert is in good condition a judgment rating is applied, but in special instances they do analysis following the procedure outlined in AASHTO.
- Does not account for soil-structure interaction
- Does not account for varying soil conditions
- The culvert is modeled using STAAD or analyzed with PennDOT’s Box 5 program.
- They do not evaluate existing culverts for pavement rehab. If the culvert is functioning properly they apply a judgment rating.

#### 8. *Delaware*

- Uses HS20 and Delaware legal loading
- Use Section 6 of AASHTO specs to apply loads
- Does not account for soil-structure interaction
- Does not account for varying soil conditions
- BRASS Culvert software is used for analysis
- They do have a similar problem but in relation to culverts with less than 2 feet of fill. They are currently working with the University of Delaware to load test these structures in order to determine a better live load distribution.
- They do not have a formal procedure, but plan to use the modified live load distribution factors and adjust the BRASS analysis results

### *9. Florida*

- LFR (HS-20) prior to 2005; LRFR 2005 and after
- Applies loads according to AASHTO specs
- LRFD program includes a beam on elastic foundation analysis to model the bottom slab soil interaction
- Does not account for varying soil conditions
- Generally use a LFD program, initially written by the North Carolina DOT, a LRFD Mathcad program, written in-house, and BARS
- Does not have a similar problem

### *10. Georgia*

- Does not load rate existing culverts at this time

### *11. Hawaii*

- Uses HS20 loading
- The application of the loading is that the full projected dead load of the soil over the culvert is conservatively used and the live load is applied per AASHTO specs
- Does not account for soil-structure interaction
- Does not account for varying soil conditions
- SAP2000 or BRASS culvert software is used for analysis
- Does not have a similar problem
- They do state that their design procedure is conservative and that the consideration of soil-structure interaction would reduce the demand capacity, especially for deeper buried culverts

### *12. Illinois*

- Uses HS20 loading, Load Factor Rating Method as described in the AASHTO Manual for Condition Evaluation of Bridges (MCEB), Sections 6.5 & 6.6.3
- Load application is based on section 6 of AASHTO specs
- Does not account for soil-structure interaction
- Does not account for varying soil conditions
- They have an in-house program that calculates the capacity of culverts and also determine the load effects per section 6 of AASHTO specs
- They do not have a similar problem. Typically, culverts are rated and replaced based on its observed condition, but have recently noticed an issue of strength with structures that have been in service 50-60 years
- They note that in MCEB section 7.4.1 there is an allowed condition for the determined capacity for older concrete structures
- They said that if the structure has been working under normal conditions for an appreciable length of time and shows no distress then no rating should be required, but frequent inspections are suggested

### *13. Indiana*

- Uses HS20 loading, for the few culverts they have that can be load rated
- In past years when they did rate their culverts they would add the soil weight as a dead load and if the height of the fill was greater than 8 ft they would ignore the live load, if fill was more than 2 ft but less than 8ft they would apply the live load according the AASHTO specs at the current time
- They use a software called Virtis but it does not work on culverts, they also have the BRASS program but have not used it thus far
- Does not account for soil-structure interaction
- Does not account for varying soil conditions
- They do not have a similar problem
- They rate their existing culverts based on levels of observed stress and provide a procedure for the regular biennial inspection to follow

### *14. Iowa*

- Uses HS20 loading
- They only apply the soil as a vertical pressure and there is no consideration of a laterally applied load. The live load is applied as described is AASHTO section 6
- Does not account for soil-structure interaction
- Does not account for varying soil conditions
- They do not consider the frame of action in the design; they only use in-house programs to analyze the loading of the culvert. They only calculate simple span or continuous span reactions without regard to end restraint. They assume the deck slab controls the rating.
- Provided a culvert design criteria
- Provided a culvert rating example

### *15. Kansas*

- They use H, Type 3, HS20, 3S2, 3-3 loading
- Loads are distributed according to AASHTO specs
- Does not account for soil-structure interaction
- Does not account for varying soil conditions
- They use BRASS Girder LFD for RCB's and BRASS Culvert for RFB's software
- They do not have a similar problem, when culverts are functioning well engineering judgment is used in the replacement decision
- They feel that pavement 6 inches or more in thickness is giving better live load distribution than AASHTO is allowing but they have not researched this yet

### *16. Louisiana*

- Does not load rate existing culverts at this time

### *17. Michigan*

- Rates for Michigan legal loads

- For the load application, the soil weight is treated as a design pressure, and the live load is distributed according to AASHTO spec 6.4
- Does not account for soil-structure interaction
- Does not account for varying soil conditions
- They use BARS or hand calculation as analytical procedures
- They do not have a similar problem

#### *18. Minnesota*

- Uses HS20 loading
- Loads are distributed according to AASHTO specs
- They do account for soil-structure interaction, but they allow AASHTO exceptions for older culverts
- They do not directly account for varying soil conditions but state that their load combinations account for this indirectly
- They use BRASS Culvert, STAAD, CANDE, and BOXCAR as analysis software
- They do have a similar problem and based on their experience with older culverts they applied the AASHTO provisions. If the physical inspection shows no distress then the culvert is not replaced.
- They are currently looking into developing new guidance to rating older culverts, in which they are considering the procedure mentioned in the AASHTO provisions.

#### *19. Missouri*

- They only perform load rating analysis when there is less than 2 ft of fill. When this occurs they load rate the culvert for the vehicles shown the vehicle load sheet.
- Loads are distributed and soil-structure interaction is based on the Load Factor Design Bridge Manual, Section 3.2 Box Culverts
- Does not account for varying soil conditions, they feel that they have used suitable fill material that will adequately transfer the load to the top to the box culvert
- They generally use the BRASS Culvert software
- They do not have a similar problem. They use a visual inspection looking for signs of distress based on existing loading conditions and will use the existing culvert to widen/extend if feasible

#### *20. Montana*

- Uses HS25, but this is a recent development
- For loading they use DL: unit weight x load factor , and
- LL: fill height x 1.75 x load factor, they then state that this is what they will use until something comes along specifically for load rating
- They do account for soil-structure interaction by 1.15 max (soil interaction factor in the design code)
- They do not account for varying soil conditions, they use 60pcf max and 30 pcf min for lateral earth pressures
- They use BRASS Culvert Version 2.2.5

- They do not have a similar problem, but appear to not replace culverts based on loading, but on hydraulic conditions

#### *21. Nebraska*

- Uses HS20 loading
- For loading purposes the soil pressure is uniformly distributed under all load cases
- Does not account for soil-structure interaction
- Does not account for varying soil conditions
- They use FRAME ACTION for analysis procedures
- They do not have a similar problem

#### *22. Nevada*

- They use HS20 and P13 truck
- They use AASHTO specs from 1977 with modification and the reference the attached plan sheet
- For soil-structure interaction and varying soil conditions they reference AASHTO and/or BRASS Culvert
- They use BRASS Culvert for design and reference design example
- They do not have a similar problem

#### *23. New Hampshire*

- They officially use HS20
- Loads are distributed according to AASHTO specs, usually 120 pcf DL and distributing through a pyramid where the base is 1.75 times the depth of the fill
- Their procedure accounts for soil-structure interaction, but not well, they have some computer programs that claim to consider soil-structure interaction but they are not always used
- Does not account for varying soil conditions
- They do not use a program for analysis purposes. All calculations are done by hand, or if precast, the calculations are done by the manufacturer
- They do not have a similar problem. They will leave a culvert in place if it has enough capacity to carry highway loads and still maintains the required flow. They note that this may be different from the design load
- They have a system where they look at the longitudinal effective span length and compare capacity to the demand for their legal loads.

#### *24. New Jersey*

- They use HS20 AASHTO Type 3 & 3-3, and NJDOT Type 3S2 (40T)
- Loads are distributed according to AASHTO specs
- Does not account for soil-structure interaction
- Does not account for varying soil conditions
- They use PennDOT's program for analysis purposes

- They do not have a similar problem because they do not require existing culverts to meet new design criteria. They do not replace existing culverts that are functioning well and are in good condition.

#### *25. New Mexico*

- Uses HS20 loading
- Loads are applied through their concrete box culverts standard drawing specs for 2007, which uses LRFD code specs
- They do account for soil-structure interaction. A new standard drawing was designed for the first series with 0-10ft of cover so the influence of the live load on the design is diminished
- Does not account for varying soil conditions
- They do not often re-rate their existing culverts
- They do not have a similar problem. They only time they re-rate a culvert is when addition fill is needed. Then they compare the ultimate strength vs. their original design in working stress.

#### *26. New York*

- Uses HS20 and HS25 loading, with the standard Military Load option
- The dead load on the top slab consists of soil weight plus the weight of the concrete slab. The program they use is capable of analyzing additional uniform dead load as well as accepting three extra concentrated dead loads. When the culvert has traffic running directly on the top slab, wheel loads are distributed as in ordinary bridges. This is also done when the height of fill on the culvert is less than 2 feet. The program will distribute wheel loads over a slab width,  $E$ , equal to  $4 + 0.06S$ , where  $S$  is the perpendicular distance between wheel centerlines. When the culvert is skewed relative to the over roadway, they magnify the intensity of the live load by reducing the distribution width. In no case shall the distribution width exceed 7 feet nor the section length of precast units. When the height of fill is greater than or equal to 2 feet, wheel loads are distributed over areas having sides equal to 1.75 times the depth of fill. When these areas overlap the wheel loads are evenly distributed over the gross area, but the total width of distribution shall not exceed the total width of the supporting slab. Their program considers two, three and four adjacent vehicle lanes, as appropriate, and selects the critical case. Appropriate AASHTO lane reduction percentages are used for the three and four lane loading cases.
- Their program is in agreement with AASHTO Articles 17.6.4.2 and 17.7.4.2, Modification of Earth Loads for Soil Structure Interaction, of the Standard Specifications, for embankment installations only. The soil-structure interaction factor,  $F_e$ , is not applicable if the Service Load Design Method is used.
- A soil unit weight is selected, 120 pcf being the default, and is used for the entire height of the soil envelope. Two cases of lateral wall earth pressure are investigated, 60 pcf maximum and 30 pcf minimum.
- The program they use was obtained in 1995 from the North Carolina Department of Transportation and modified for New York State use by NYSDOT staff and the



Precast Concrete Association of New York (PCANY). The program's method of analysis is the stiffness method.

- It is assumed that loading applied to the top slab will be uniformly distributed over the whole bottom slab. They feel this is a reasonable assumption since a mat of granular material is placed beneath the bottom slab of the culvert, and there is usually a lack of precise soil information for each site.
- Typically if the culvert is in good condition, and functioning from a hydraulic standpoint, they would not necessarily replace an existing culvert that does not meet current design requirements.

#### *27. North Carolina*

- Does not load rate existing culverts at this time
- The wheel loads are distributed over squares having sides equal to 1.75 times the depth of the fill. When the squares overlap, the wheel loads are spread evenly over the gross area
- Does not account for soil-structure interaction
- Does not account for varying soil conditions
- They use an in-house program to perform a frame analysis on the "strip" of the culvert, using the stiffness method. The analysis determines the maximum load effects and completes a standard concrete design
- They do not have a similar problem

#### *28. North Dakota*

- Uses HS20 loading
- To load the culverts they follow section 6 Culverts in the 2002 Interim Revisions to the Standard Specs for Highways and Bridges. Dead loads per section 6.2 and live loads per section 6.4
- Does not account for soil-structure interaction
- Does not account for varying soil conditions
- They use an in-house program that determines the required reinforcing for a particular loading
- They do not have a similar problem, but do suggest the use of the *Manual for Condition and Evaluation of Bridges* as the method they use to evaluate concrete slabs that have little known information

#### *29. Ohio*

- They load rate existing RC Box Culverts for AASHTO HS20 and four legal Ohio loads
- They use BRASS Culvert which is based on AASHTO specs
- This process does account for soil-structure interaction
- Does not account for varying soil conditions
- They do not have a similar problem
- They have sponsored some research on concrete arches and also some research in Corrugated Metal Pipe Culverts.

- They note that several short span culverts designed using ASTM tables do not rate very well using the BRASS Culvert program

### *30. Oregon*

- Uses HL-93 Truck/Tandem LL, and states that the truck can have up to two axles on the culvert at one time
- Unit weights of in-place, compacted backfill beside and over box culverts are in accordance with AASHTO LRFD Table 3.5.1-1 (120pcf typically assumed). A design depth of live load surcharge (HLS) of 2ft is used in accordance with AASHTO LRFD. Load factors for horizontal and vertical earth pressures are in accordance with AASHTO LRFD Table 3.4.1-1 & 2: 0.90min to 1.35max for horizontal earth pressure, at-rest; and 0.90min to 1.30max for vertical earth pressures, rigid buried structures. If the backfill depth over the top of the box culvert (H) is less than 2ft, AASHTO LRFD Eq. 4.6.2.10.2-1 is used – otherwise the width is determined as the maximum of Eq. 4.6.2.10.2-1 or from the provisions in AASHTO LRFD 3.6.1.2.6 as illustrated in Figure 3. The 1.15 factor is not applied to the depth term in Eq. 3.6.1.2.6. In the direction parallel to the span, the axle loads are modeled as point loads. The allowable increase in load length is neglected as allowed in LRFD C4.6.2.10.2.
- They do not directly account for soil-structure interaction. ODOT used the GT-Strudl finite element structural analysis software to determine force effects. The soil response to box culvert loading is represented by a “soft spring” (vertical coefficient of subgrade reaction).
- They do not directly account for varying soil conditions; however, ODOT is looking closely at the box culvert differential settlement countermeasures being developed by Florida DOT
- ODOT used the GT-Strudl finite element structural analysis software
- They do not have a similar problem
- They are currently re-doing the calculations for all their standard drawings. The new calculations and updated drawings will be in LRFD. They did a comparison between their old standard drawings that were developed using LFD and determined the designs shown on the drawings only needed minor modifications to meet the new design standard.
- ODOT is in the process of updating existing standard drawings for gravity/cantilever retaining walls and box culverts from ASD\LFD to AASHTO LRFD Specifications.

### *31. South Carolina*

- They evaluate the culverts under the criteria in which it was designed
- They apply the loads according to AASHTO Standard Specs for Highways and Bridges or AASHTO LRFD Bridge Design Specs.
- They do account for soil-structure interaction
- They consider existing information for the soil conditions, and for widening they conduct a subsurface investigation to design the foundation.

- They use BRASS Culvert version 2.2.6 for culverts that are cast-in-place and BOXCAR version 2.03 for precast culverts
- They do not have a similar problem
- Culverts of bridge length 20ft. or greater are checked on a regular basis, but culverts less than 20ft. are checked by maintenance offices before the culverts are extended.

### *32. South Dakota*

- Uses HS25 loading for new design but do not currently rate their box culverts
- For design purposed loads are distributed according to AASHTO specs
- Does not account for soil-structure interaction
- Does not account for varying soil conditions
- They have their own software, South Dakota Box, which uses ASD, but are now transitioning to BRASS Culvert which uses LRFD
- They do not have a similar problem

### *33. Tennessee*

- Does not load rate existing culverts at this time
- Notes a quote from the *MCEB*, “A concrete bridge need not be posted for restricted loading when it has been carrying normal traffic for an appreciable amount of time.”

### *34. Utah*

- Depending on what design standard was used, is what controls the loading condition they use for the rating. For ASD they use HS-20 and for LRFD they use HL-93
- They apply the dead load as the unit weight of the soil times the thickness and applied uniformly, and the live load thru the fill effects are taken with a slope of 1:2
- Does not account for soil-structure interaction
- Does not account for varying soil conditions
- They use the PennDOT’s software which uses the direct stiffness method
- They replace culverts based on existing condition rather than load rating

### *35. Virginia*

- Uses HS25 loading
- Loads are distributed according to AASHTO specs
- Does not account for soil-structure interaction
- They do not account for varying soil conditions when loading, but they do consider the variability when designing the foundation to support the culvert
- They previously used an in-house program which was a modification of the old North Carolina box program, but have now adopted the BRASS Culvert software

- They do not have a similar problem. Culverts that are functioning well do not get replaced unless the new required fill height is too much of a load for the old culvert to handle
- They typically see that culverts are replaced due to other criteria besides loading; such as relocation or hydraulic deficiencies

### *36. Washington*

- Uses HS20 loading, three legal and two overload trucks (Types 1,2 & 3, OL-1 & OL-2 found in Bridge Design Manual 13.1.1.G)
- They apply the soil as a uniform surcharge and reference their calculations, Sheet 1 for distribution factor or truck lane multiplier.
- They do account for soil structure interaction and earth pressure, which is significant in the Br. 169/30C example.
- Does not account for varying soil conditions
- For analysis they use Concrete Bridge, a program owned by WSDOT
- They do not have a similar problem
- They seldom have plans for culverts, but when they do they rely on inspection results and perform administrative ratings

### *37. West Virginia*

- Does not load rate existing culverts at this time
- They do not replace culverts that are functioning well and are in good condition

### *38. Wyoming*

- They use Type 3, HS20, 3S2, 3-3 loading
- Loads are distributed according to AASHTO specs
- Does not account for soil-structure interaction
- Does not account for varying soil conditions
- They use the BRASS Culvert software
- They do have a similar problem, they address it in various ways, including replacing the culvert if the grade is to be changed or just extend the culvert if the grade is not being changed.

Additional information is presented in the detailed Logs of Activity (documents) archived in the project research file. Information regarding the State DOT respondents and their contact information is also included in these documents. Reference materials that were provided by any of the State DOTs are also included in these documents.

#### 4. Results from the State DOT Survey

Table 2.2 shows the different types of loads used to rate the culverts. More load types exist than there are responding states that rate culverts, because most responses included more than one type of loading. Six of the responding states do not load rate their culverts.

**TABLE 2.2. LOAD TYPES**

HS20	HS25	HS15	STATE LEGAL	OTHER
23	4	1	7	7

Table 2.3 shows the how each of the responding states that evaluate culverts apply the load to the concrete box culvert. Out of these 32 loading scenarios, only 15 incorporate soil-structure interaction and only 7 consider the effects of varying soil conditions.

**TABLE 2.3. LOAD APPLICATION**

AASHTO	CUSTOM	OTHER
21	9	2

The following Table 2.4 illustrates the breakdown of analytical software and methods used by the responding states to calculate and analyze the effects of the load application directly on the concrete box culvert.

**TABLE 2.4. ANALYTICAL PROGRAMS**

BRASS	14	BOXCAR	2
GTSTRUDL	2	BARS	2
RISA 3D	1	FRAME-ACTION	1
CANDE	2	PENNDOT	2
SAP2000	2	IN-HOUSE	8
CTBC	1	HAND CALC.	3
STAAD	1		

The interviews revealed that only three of the responding states had a problem similar to that which TxDOT is experiencing, and only four states have sponsored research that could be considered relevant to this subject.

## 5. Conclusions

In conclusion, only three states (Delaware, Illinois, and Minnesota) have culvert load rating problems that can be considered similar to that which TxDOT is currently experiencing. Delaware's problem is in relation to culverts with less than 2 feet of fill and they are currently working with the University of Delaware to research possible solutions. Illinois has recently noticed a strength issue with structures that have been in service for 50-60 years. They are looking to provisions in the *Manual for Condition Evaluation of Bridges* for a possible solution. Minnesota has developed some exceptions to AASHTO specifications to apply when rating older culverts. They are also looking into developing new guidance for rating older culverts.

It should be noted that the responses do not directly correlate to what is actually being done in the load rating procedure. For example, two states that claimed to use AASHTO specifications to apply the load gave different answers to the questions about whether their procedure accounted for soil-structure interaction and varying soil conditions. This suggests that there is definite confusion as to what the AASHTO specifications require and what conditions are accounted for.

It seems that most of the responding states do not replace their culverts on the basis of load rating, but on the basis of hydraulic functionality. These states all seem to go by the adage, "If it's not broke, don't fix it." The justification of this adage comes from a quote in the *MCEB*, referenced several times by the responding states, "A concrete bridge need not be posted for restricted loading when it has been carrying normal traffic for an appreciable amount of time and shows no distress."

## 6. TxDOT DISTRICT SURVEY

### 1. Purpose

The intent of this survey was to obtain responses from each of the 25 TxDOT District Bridge Engineers regarding how they approach the issue of load rating concrete box culverts. The survey questions focused on who in the district is doing the load ratings, how they are doing them, and the reasons that bring about the need to load rate the concrete box culverts.

### 2. District Notes

This section outlines the responses provided by the Bridge Engineer within the TxDOT districts.

**Abilene:** Left messages, no response.

**Amarillo:** Relies on the Bridge Division in Austin or the consultants that do the bridge inspection (SDW and Associates) for culverts that need to be rated. No load rating is done in house. The load rating is deemed necessary after the failing of a visual inspection and when the posted operating load is less than HS 20.

**Atlanta:** Relies on the Bridge Division in Austin or the consultants that do the bridge inspection (Klotz and Associates, SDW and Associates) for culverts that need to be rated. No load rating is done in house. Consultants seldom load rate culverts because when they do and want to change to operating rating of a culvert TxDOT will not let them without doing an extensive investigation before-hand, so the load rating is typically not pursued any further. If the load rating is necessary it is performed after the failure of a visual inspection.

**Austin:** Left messages, no response.

**Beaumont:** Left messages, no response.

**Brownwood:** Left messages, no response.

**Bryan:** Relies on the Bridge Division in Austin for culverts that need to be rated. No load rating is done in house. They send culvert rating request to Austin when deteriorating conditions warrant, after failure of a visual inspection, and before widening, but these situations do not occur frequently. They usually replace culverts due to hydraulic capacity demands or deteriorating structural conditions. They state that the difference of construction cost is minimal between replacing a culvert versus lengthening a culvert.

**Childress:** Relies on the Bridge Division in Austin or the consultants that do the bridge inspection (JPH Consulting, Inc., Edwards and Kelsey, and Structural Diagnostics Inc.) for culverts that need to be rated. No load rating is done in house. The consultants conduct a load rating when the culvert scores a 4 or below on a 0-9 scale during a visual inspection and then make a recommendation to Austin that the posted load should be changed. They only provide the consultants with the guidelines from Austin and the structure's history file.

**Corpus Christi:** Left messages, no response.

**Dallas:** Culverts are load-rated very rarely, practically never, in this office. Any culvert design or analysis is done using CULV5. If culvert problems are encountered, they contact the Bridge Division.

**El Paso:** No one in this office does load ratings or has any knowledge of how or when they would be done. They believe that if load rating is being done it is being done by Austin.

**Fort Worth:** If a culvert fails a visual inspection, this information is passed on to Austin so the culvert can be load rated.

**Houston:** They do not do load rating in house, but the consultant (Structural Diagnostics Inc.) that does the bi-annual bridge inspections does load rate the culverts that fail the visual inspection. The Houston District provides the consultants with the construction details of the structure and the structure's history file.

**Laredo:** They just started a bridge division in this district and have not load rated any structures as of this time. Anything prior was done by Austin.

**Lubbock:** Consultants do the load ratings after a culvert fails its visual bi-annual inspection, but these inspections only include bridge class culverts, which are culverts that span twenty feet or more.

**Lufkin:** Left messages, no response.

**Odessa:** They rely on Austin for their load ratings. If a culvert fails a visual inspection from the bi-annual bridge inspection conducted by the TxDOT-approved consultants, the consultants will load rate the culvert in question. For culverts that are on roads that are to be widened they send it to Austin to be rated.

**Paris:** Relies on the consultants that do the bi-annual bridge inspections. For off-system structures they use Klotz and Associates and Clear Span Engineering. For on-system structures they use Maverick Engineering Inc. and Edwards and Kelsey. There is no load rating done in-house, but when it is done by the consultants, it is done after a structure has failed a visual inspection. They provide the consultants with the structure's history file and its construction details.

**Pharr:** They do not load rate culverts or seem to have consultants load rate culverts. They use CULV-5 and do a redesign with the new proposed fill height to see if the culvert can hold the load. If it cannot, they replace the culvert.

**San Angelo:** Left messages, no response.

**San Antonio:** Not contacted.

**Tyler:** They rely on the Austin Bridge Division and consultants (Howell Engineering) to load rate their culverts. The consultants usually end up rating one culvert during the bi-annual bridge inspection because it has failed a visual inspection. There is rarely a need for the district to request that Austin load rate a culvert, outside of the bi-annual inspection.



**Waco:** They very seldom load rate culverts in-house and it has been a few years since they have done a load rating. Otherwise the consultants that conduct the bi-annual bridge inspections do the load rating for bridge class culverts that fail the visual inspection.

**Wichita Falls:** They do not do any load rating in-house. If load rating is done it is done by the consultants that conduct the bi-annual bridge inspections, and only after the structure fails a visual inspection.

**Yoakum:** They do not rate culverts, but did note that their files are in need of being updated.

### **3. Summary**

The results of the TxDOT District survey show that nearly all culvert load rating for TxDOT is done by the Bridge Division in Austin, or by consultants that conduct TxDOT's bi-annual bridge inspections. Even when the consultants do the load ratings, the calculations are still sent to Austin for review to ensure that the proper procedure was used, and for approval of changes. It is very seldom that load rating is done inside a TxDOT district office. Since TxDOT provides no specific guidance to the consultants about load rating, the load rating procedures these consultants are following are unknown. The only culverts that are inspected are bridge class; that is, culverts that are 20 feet in length or longer. This leaves a large number of culverts that receive no regular attention.

## 7. CONCLUSIONS

The following methods, approaches and conclusions can be drawn from the academic literature that addresses the culvert load rating.

1. For embankment installed culverts, it is doubtful that a more accurate analysis will allow for reduction of excessive overconservatism in load ratings for existing culverts.
2. For trench and imperfect trench culverts, it is possible that a more refined analysis will allow for reduction of excessive overconservatism in load ratings while maintaining an acceptable factor of safety.
3. For culverts which have been in service for 50-plus years, it seems reasonable to assume that subsurface stresses are stable and it is not clear whether the embankment/trench dichotomy affects soil stresses.
4. By considering more sophisticated methods of live load distribution, a reasonable decrease in culvert load can be predicted.
5. By considering the effect of pavement stiffness, the live load effect may be further reduced.
6. Finite element analysis techniques will be required to solve this problem.
7. CANDE and ABAQUS are among the more powerful finite element programs for this application.

The State DOT survey indicated that only three states (Delaware, Illinois, and Minnesota) have culvert load rating problems that can be considered similar to that which TxDOT is currently experiencing. Most of the responding states do not replace their culverts on the basis of load rating, but on the basis of hydraulic functionality. These states prominently cite a quote in the *MCEB*: “A concrete bridge need not be posted for restricted loading when it has been carrying normal traffic for an appreciable amount of time and shows no distress.”

Results from the TxDOT District survey show that nearly all culvert load rating for TxDOT is done by the Bridge Division in Austin, or by consultants that conduct TxDOT’s bi-annual bridge inspections. It is very seldom that load rating is done inside a TxDOT district office.

This information was used to inform and address TxDOT’s culvert load rating questions. Subsequent chapters of this report discuss the development of the *Culvert Rating Guide*, and the research by which the *Culvert Rating Guide* was validated.

### **3. DEVELOPMENT OF THE CULVERT RATING GUIDE**

#### **1. OVERVIEW**

This chapter describes the development of the TxDOT *Culvert Rating Guide*. The stated purpose of the *Culvert Rating Guide* is “to present a clear, repeatable and valid procedure for TxDOT engineers and their consultants to use for load rating culverts in the TxDOT roadway system.”

It is appropriate to begin with a brief summary of the culvert load rating process. This is followed by detailed discussion of key decisions addressed during development of the *Culvert Rating Guide* including reliability considerations, selection of appropriate analytical models for production load rating of culverts, and articulation of three levels of analysis; namely, Level 1 (two -dimensional, simply-supported structural frame model), Level 2 (two dimensional structural frame model with soil springs), and Level 3 (two dimensional finite element soil-structure interaction model). This is followed by a chapter-by-chapter commentary about the *Culvert Rating Guide*.

## 2. A BRIEF SUMMARY OF THE CULVERT LOAD RATING PROCESS

The culvert load rating process is one aspect of the inspection process and consists of determining the safe load-carrying capacity of the culvert structure, determining whether specific legal or overweight vehicles can safely cross the culvert, and determining if the culvert needs to be restricted and if so, what level of load posting is required.

Load posting consists of placing signage by the structure indicating the largest truck that may be permitted across the structure. The flow chart from the TxDOT *Bridge Inspection Manual* (Figure 3.1) defines the culvert load posting process (TxDOT 2002). Culverts may be load posted at the operating rating if the culvert condition rating is greater than that defined in the flow chart. Otherwise the culvert must be load posted at the inventory rating. Load posting, then, directly interacts with culvert load rating.

The basic culvert load rating procedure is as follows. Per Equation 1.1, the main variables are culvert capacity, the dead load demand, and live load demand. Culvert capacity is established from equations set forth in AASHTO policy, whereas dead load and live load demands must be determined by structural modeling (computer analyses). While this seems simple enough, the challenge is to obtain reliable values for each of these variables.

A “road map” of the culvert rating process helps avoid confusion. Figure 3.2 presents the load-rating process in terms of a flow chart. The first step is to identify the culvert that will be load rated. As noted, this might be because the culvert failed a scheduled inspection or for some other reason. Either way, a visual inspection of the culvert is necessary. For all intents and purposes, the culvert load rating process begins here.

The load rating factor calculations require determination of both culvert capacity and dead and live load demands. It is helpful, therefore, to think of culvert capacity and demand calculations as separate and distinct aspects of the load rating process.

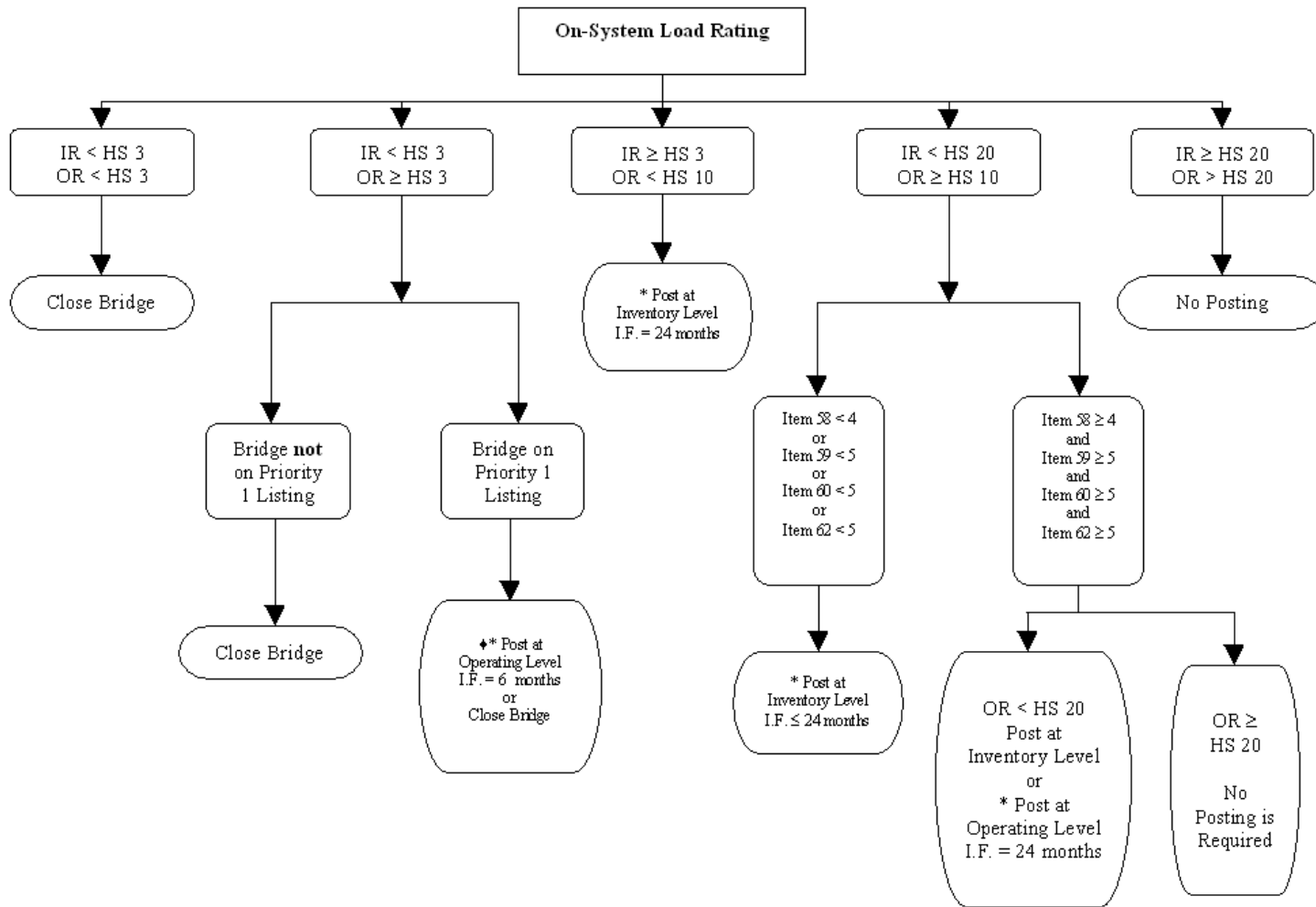

FIGURE 3.1. LOAD POSTING GUIDELINES (TXDOT BRIDGE INSPECTION MANUAL FIG.5-3).

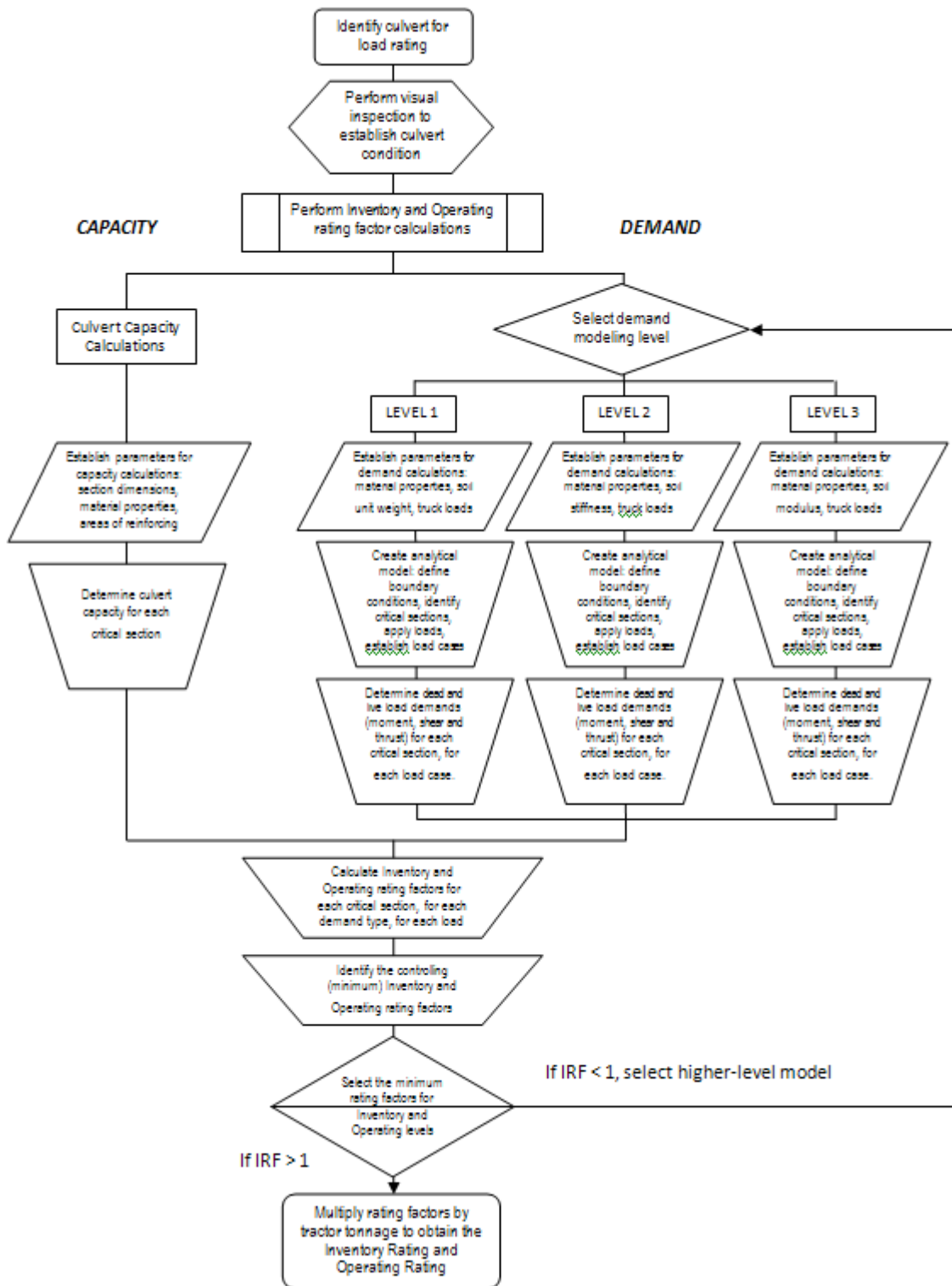

FIGURE 3.2. FLOW CHART DEPICTING THE TXDOT CULVERT LOAD RATING PROCESS.

Capacity calculations are based on equations established in AASHTO policy. These do not require a computer model and are independent of the level of analysis selected for demand calculations. Inputs for capacity calculations are obtained from the construction drawings, visual inspection, and AASHTO policy and consist of strength properties for concrete and steel, culvert section dimensions, and the location and amount of reinforcing steel. The calculations determine moment, shear and thrust capacity for each critical section of the culvert structure.

Determination of dead and live load demands *do* require computer modeling. Thus the first decision to be made is to select the type of analytical model for the load rating process. The *Culvert Rating Guide* describes three levels of analysis, each with increasing analytical sophistication. A trade-off exists between sophistication of analysis and required work effort. The advanced models require more work but typically yield more accurate results.

Once the level of analysis is chosen, it is necessary to gather data to facilitate creation of the analytical model. Modeling parameters include but are not limited to culvert dimensions, properties of the concrete and reinforcing steel, soil parameters, the location and amount of reinforcing steel, and culvert installation details.

With this information, the load rater can create the analytical (computer) model from which s/he will obtain demand moments, shears and thrusts. This involves laying out the model, specifying boundary conditions, identifying critical sections, applying loads, and defining load cases.

Determining the inventory and operating load rating factors requires multiple sets of calculations from the computer model. This is because demand loads and their corresponding capacity must be determined for each critical section, for each failure mode, and for multiple load cases. From these sets of calculations, the load rater selects the controlling (minimum) operating and inventory rating factor for each critical section, for each load case. The minimum operating and inventory rating factors from the critical sections are the rating factors for the culvert.

A decision is required at this point. If the inventory and operating rating factors are greater than 1.0, the culvert will not require load posting. It is unrestricted. This means that the culvert load rating can be calculated by multiplying the rating factors by the tractor tonnage (for HS-20 trucks, this is 20 tons) to determine the operating (OR) and inventory (IR) load ratings. However, if either the inventory rating factor or the operating rating factor is less than 1.0, the culvert may require load posting. As an alternative to posting, the load rater may elect to perform the calculations again, using a higher level (more sophisticated) modeling approach.

This is the basic load rating procedure articulated in the *Culvert Rating Guide*. Development of this procedure required that several key design issues be addressed, and the next sections of this report discuss those decisions.

### **3. PRIMARY DEVELOPMENT GOAL: RELIABILITY**

Reliability is one of the most important qualities of any sort of predictive engineering analysis and was therefore one of the primary concerns in developing the *Culvert Rating Guide*. For this discussion, reliability means the coherence between the predicted outcome and the measured event. The predicted value may be above or below the measured value, but the closer the predicted value is to the measured value, the more reliable the prediction method is. Several factors affect reliability for culvert load rating contexts. These include repeatability, capacity calculation approach, model input variables and demand model sophistication.

#### ***1. Repeatability***

Repeatability of the modeling procedure has an immediate and direct impact on reliability. If several engineers load rate a structure in the same way and produce several different load ratings, very little confidence should be placed in the results. There is only one real load rating. The most reliable procedure will identify only this load rating. Ideally, a procedure would be clearly articulated to remove inconsistencies, identify unique levels of reliability and do so repeatedly. A repeatable load rating procedure should, for a given structure, produce a single inventory rating and a single operating rating. Engineers should be able to, within reason, agree upon and reproduce those ratings for a given culvert. Without a repeatable load rating procedure, the load rating for a structure holds no real or certain meaning. The decision to develop the *Culvert Rating Guide* derived in part from a lack of repeatability in TxDOT's current state of practice.

#### ***2. Capacity Calculation Approach***

The capacity calculations also affect reliability. The capacity of a section is determined by considering the concrete and steel properties and using these to calculate the moment, shear and thrust capacity. Each of these capacities can be determined several ways. Ultimate moment capacity can be calculated by models such as Whitney's stress block, the modified Hognestad model, the Kupfer and Gerstle model or the Kent and Park model. Shear can be determined using the ACI/AASHTO semi-empirical method, modified compression field theory or truss methods. Axial load can be considered uniaxial or combined with moment and shear. The *Culvert Rating Guide* must provide capacity calculation guidance that is widely accepted and generally understood by the majority of structural engineers, and that is considered sufficiently reliable for load rating analysis.

#### ***3. Model Input Variables***

Another factor that affects reliability is the input variables for the various models; that is, the geometric, material, and loading parameters used to calculate the load rating. Model input variables have perhaps the strongest effect on reliability. These variables can be obtained several different ways. They may be determined from construction plans, manuals, and published references. They can be determined by correlated tests. They can also be determined by field investigations and lab tests. While it is recognized that the more case-specific methods increase the reliability of the resulting answer, the *Culvert Rating Guide*



must provide guidance for obtaining input parameters, either from published sources or through site specific data-gathering approaches.

#### 4. *Model Sophistication*

It has been noted that the reliability of a culvert load rating (i.e. the load rating value) also depends on the degree of sophistication of the demand model. The load rating method, capacity determination, and input variables are often defined by policy. However, model sophistication is rarely controlled by policy. Instead, this is generally left to the discretion of the engineer. As a general statement, the assumptions, simplifications and mathematical structures of various demand modeling tools can have a significant effect on modeling reliability for culvert load rating analysis. Therefore, in order for the *Culvert Rating Guide* to be reliable, the issue of model sophistication must be bounded and directed. Model sophistication reliability effects primarily occur in two classes: soil-structure interaction and live load distribution. These will be discussed as they are resolved in the *Culvert Rating Guide*.

##### 1. *Soil-Structure Interaction*

For culvert applications, soil-structure interaction is expressed primarily in terms of soil arching. Soil arching, in turn, can be both global – which has to do with culvert installation method – and local – which has to do with soil response to culvert deflection. Because this research project is primarily focused on the load rating of *in-service* culverts, the effects of global soil arching are assumed to have dissipated. This assumption would not necessarily be valid for newly-constructed culverts, however. Local soil arching does affect culvert load ratings.

Soil-structure interaction, by way of soil arching, is a very real phenomenon that must be considered in order to accurately predict culvert demands. Models which consider the full effect of soil arching should produce the most reliable demands. However, such modeling can be time-consuming and labor intensive. Because of this, many models incorporate assumptions to simplify the determination of demands. To say it another way, simplifying assumptions are used to more easily calculate less reliable demands that are, ostensibly, higher than actual values, which in turn results in lower or more conservative load ratings. This is a form of over-conservatism associated with model sophistication. These simplifications will be discussed at length in the following section on analytical models and programs.

##### 2. *Live Load Distributions*

The other area where model sophistication affects reliability is live load distribution. Vehicles produce complicated load paths. Typically the loads pass from the vehicle axle to the tire, through a patch of tire and into the pavement. In the pavement, the load is distributed by the pavement stiffness and then passes as a diffused pressure into the bedding and supporting soil. In the supporting soil, the pressure is further diffused throughout the soil mass. If a culvert happens to reside in the soil mass, the load is further distributed into the culvert top slab and walls and back into the soil mass through the bottom slab. To further

complicate matters, vehicles produce dynamic pulse loading which behaves differently than static and quasi-static loadings. Attempting to model this complex behavior is very difficult.

Much research has been done to explore how live loads from vehicles affect buried structures. Section 2.2.3 of this report discusses the previous research in detail.

Modeling sophistication strongly affects the overall reliability of demand calculations and load ratings. To the extent that less sophisticated models produce excess conservatism, an increase in the model sophistication is anticipated to reduce over-conservatism. As the sophistication of the models increases, some of the excess conservatism can be removed to produce more reliable, that is, higher, load ratings.

Though the operational hypothesis of this present research study assumes a correlation between modeling sophistication and reliability, it must be noted that model sophistication does not guarantee load rating reliability. Without a repeatable load rating procedure and representative input parameters for demand and capacity models, the load rating will not be reliable. In fact, with non-representative input parameters and an unreliable procedure, the resulting load rating could be higher than reality, unconservative and possibly unsafe. This is the reason for the *Culvert Rating Guide*.

## ***5. Reliability Further Discussed***

For culvert load ratings, reliability can be considered as a function of three key concepts: predicted behavior, accepted conservatism and load-soil-structure interaction.

### *1. Predicted Behavior*

In an ideal load-rating procedure, the *actual* behavior of the soil-structure system would be perfectly predicted. For an engineer whose primary concern is accurate predictions (not safety), this is the only objective. Therefore, the engineer would use application-specific soil properties, highly-directed modeling techniques and capacity calculations designed to accurately predict soil-structure behavior as it happens in the real world. This is a basic requirement for a reliable load rating.

### *2. Accepted Conservatism*

The second aspect of reliability is accepted conservatism which acknowledges uncertainties in the design and construction process. Engineers are concerned about safety as well as accuracy; therefore, the prediction of actual soil-structure behavior may be intentionally adjusted to ensure safe predictions. That is, the material properties, capacity calculations and modeling techniques may be modified or simplified to ensure conservative predictions. The load factors in the load rating equations are primarily concerned with predicting behavior in the worst case scenario, not the actual real world behavior. The capacity equations have an accepted and intentional amount of conservatism. Even the concrete and steel material properties are assumed to be weaker than reality. Accepted engineering conservatism for soil properties is less defined, but also exists. The net effect is that an accepted degree of conservatism will exist in the culvert load rating process.

### 3. *Load-Soil-Structure Interaction*

The last element of reliability affecting culvert load ratings is load-soil-structure interaction. The most basic models include over-conservatism to acknowledge their lack of refinement relative to the load-soil-structure interaction phenomenon. More sophisticated models consider load-soil-structure interaction. For this reason, more sophisticated models should produce higher load ratings as the over-conservatism associated with load-soil-structure interaction is removed.

The philosophy used in the *Culvert Rating Guide* is built upon this assumption. When the different analytical models are discussed, no net change is assumed to occur in the balance of actual behavior and accepted conservatism. Rather, the investigated concept is load-soil-structure interaction. Modeling sophistication is what allows the influence of load-soil-structure interaction (excess capacity) to be identified and the associated over-conservatism to be removed. A corollary assumption is that the load ratings produced by more sophisticated models will increase by reducing over-conservatism but will not produce load ratings above those which exist in reality.

#### 4. SELECTION OF ANALYTICAL MODELS

##### 1. Analytical Models and Programs for Determining Demand

Many models are available to determine live and dead load demands for culvert load rating problems. Determining which of the models to use can be a daunting and difficult task. Discussing the types of available models and discussing their similarities and differences will help identify those models which are most appropriate for culvert load rating. Table 3.1 shows the nine available model types and their distinguishing characteristics.

TABLE 3.1. SUMMARY OF MODELS

MODEL #	GENERAL (GEN) / CULVERT (CULV)	TWO DIMENSIONS (2D) / THREE DIMENSIONS (3D)	LINEAR-ELASTIC (LE) / NON-LINEAR (NL)	STRUCTURAL (STRUC) / SOIL-STRUCTURAL (S-S)
1	CULV	2D	LE	STRUC
2	GEN	2D	LE	STRUC
3	GEN	2D	NL	STRUC
4	GEN	2D	LE	S-S
5	GEN	2D	NL	S-S
6	GEN	3D	LE	STRUC
7	GEN	3D	NL	STRUC
8	GEN	3D	LE	S-S
9	GEN	3D	NL	S-S

### 1. Prepackaged, Two-Dimensional, Culvert Models

The simplest models are two-dimensional frame models which rely on static loading (loads are balanced between top and bottom slabs) and frame analysis matrix methods. Two-dimensional frame models have many advantages. They are simple to construct with often fewer than a dozen nodes; some programs even construct the model automatically from a few culvert geometry properties. Their structural stiffness matrices are smaller and therefore require less computation time and introduce fewer rounding errors. The beam elements themselves are built around a proven and well understood mechanics of materials model. Basically, these models take the most conservative interpretation of AASHTO policy requirements and apply them to a simply-supported frame model. Figure 3.3 illustrates a half space model where member self-weight is automatically determined. Loads include vertical dead and live load, lateral (or horizontal) dead and live load and balanced upward dead and live load forces on the base of the culvert including self-weight.

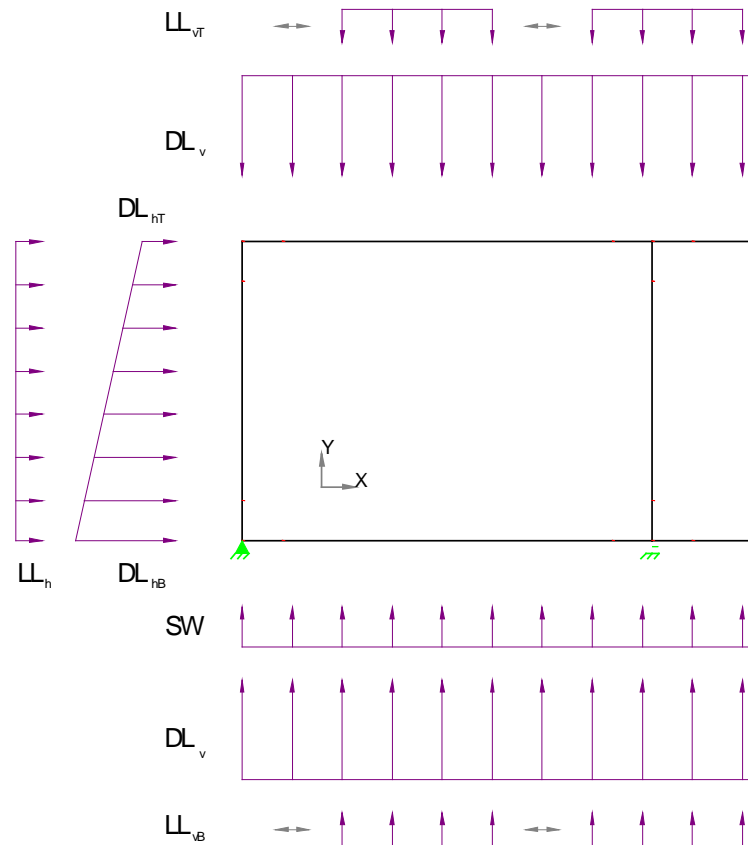

FIGURE 3.3. PREPACKAGED, TWO-DIMENSIONAL CULVERT MODELS LOADING DIAGRAM. (TXDOT, 2009).

This sort of model tends to produce very conservative demands. Moment, particularly in the bottom slab, tends to be overly conservative. For design purposes this is very acceptable; culverts are designed to be stouter than they need to be. For load rating purposes, however, such over-conservatism is less desirable, particularly if sufficient conservatism exist elsewhere. What this sort of model does very poorly is account for “real world” behavior such as soil arching and the effects of differential settlement in the foundation. This model is the least sophisticated model and therefore should produce the most conservative load rating.

## 2. General, Two-Dimensional, Linear-Elastic, Structural Models

The second model type is the general, two-dimensional, linear-elastic structural model. This model is very similar to the first: it uses AASHTO prescribed loads, it is based on matrix methods, and the structural elements are modeled as beams. The difference is that this model is designed for general structural purposes, so the engineer has greater control over model generation. The real improvement is that intermediate spring supports may be used to support the culvert instead of balanced upward forces. Figure 3.4 illustrates the loading diagram for this model.

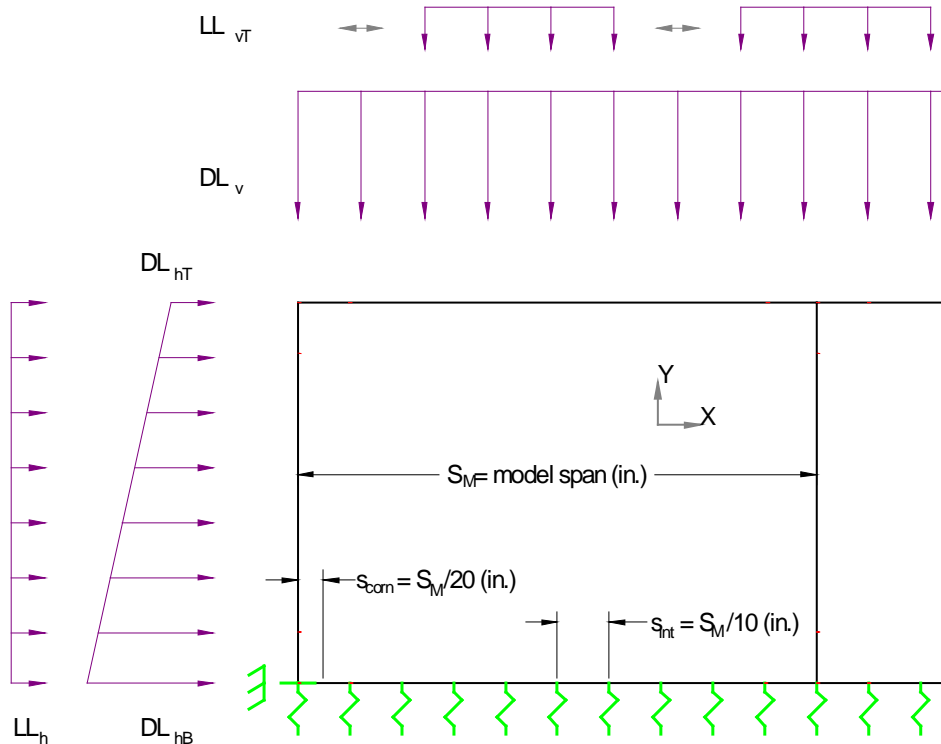

FIGURE 3.4. GENERAL, TWO-DIMENSIONAL, LINEAR-ELASTIC STRUCTURAL FRAME MODELS LOADING DIAGRAM.(TXDOT, 2009)

This means that instead of applying loads to the bottom of the culvert, springs are spaced uniformly across the bottom slab to provide support. Though the model still does not model soil-structure interactions, it does account for the effect of differential settlement in the foundation and allows for more natural distributions of the live load across the bottom slab. The result, ostensibly, is improved reliability in the bottom slab demands.

### *3. General, Two-Dimensional, Non-Linear, Structural Models*

The general, two-dimensional, non-linear, structural model is another improvement upon the linear-elastic model. The key change is that the material models for the culvert (steel, concrete, aluminum, etc.) have been improved to consider non-linear behavior. For example, as reinforced concrete deforms under load, it goes through periods of decreased stiffness as the concrete cracks and varying stiffness as the reinforcing steel begins to yield. The result is a non-linear stress-strain curve.

Models with these capabilities are popular for dynamic, fatigue or post-ultimate loading such as earthquake or dynamic wind design. Culverts however are generally not prone to extremely dynamic or fatigue loading, and any post-ultimate behavior in a culvert would result in very poor visual inspection performance. So while this is a more sophisticated model, reinforced box culvert behavior does not typically venture into the ranges where this increase in sophistication provides more reliability. This model will not be discussed any further.

4. *General, Two-Dimensional, Linear-Elastic, Soil-Structural Models*

The fourth model to consider is the two-dimensional, linear-elastic, soil-structural model. This is the most basic of the finite-element models. In general, finite-element programs allow for “modeling phenomena not described by the culvert specific codes” and for graphical investigations of the results (Katona M. G., CANDE-a Modern Approach for the Structural Design and Analysis of Buried Culverts, 1976). This particular finite-element model builds upon the concepts of the two-dimensional, linear-elastic structural frame model. However, instead of applying AASHTO loads directly to the structural elements, the surrounding soil mass is modeled using linear-elastic finite-elements. Figure 3.5 shows the load condition for this model.

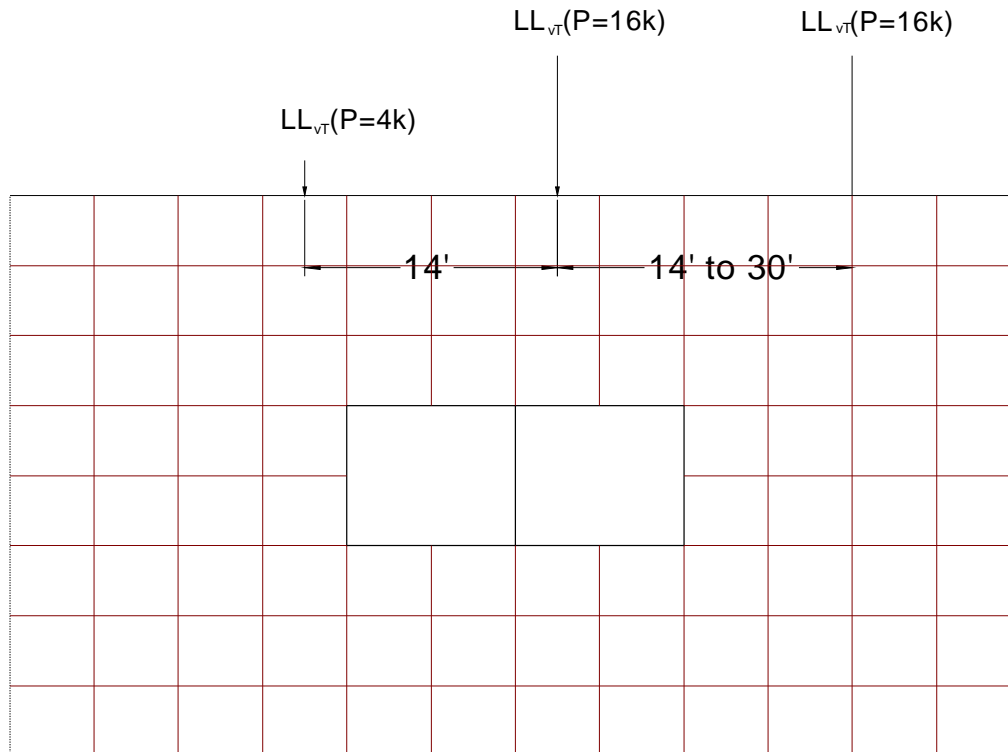

FIGURE 3.5. GENERAL, TWO-DIMENSIONAL, LINEAR-ELASTIC SOIL-STRUCTURE INTERACTION MODELS LOADING DIAGRAM.(TXDOT, 2009)

This model allows the culvert and soil self-weight to be automatically distributed through body forces and the live load to be distributed automatically in one plane. One limitation is that this model allows for soil tension and shear at large displacements. However, it does model soil-structure interaction and differential settlement in the foundation. For the increased complexity associated with moving from a frame model to a finite-element model, reliability is gained by accounting for soil-structure interaction.



### 5. *General, Two-Dimensional, Non-Linear, Soil-Structural Models*

The two-dimensional, non-linear, soil-structure model is an improvement over the linear-elastic finite-element model. Again, only the material models are improved. Like the non-linear structural model, the culvert material (concrete, steel, etc.) can be modeled non-linearly. The big difference is that the soil can also be modeled using non-linear models. Such models include elasto-plastic with Mohr-Coulomb failure, soil hardening with stress dependent stiffness and Mohr-Coulomb failure, Hardin, Duncan, and bilinear, of which Duncan is the most popular (Katona M. G., CANDE-a Modern Approach for the Structural Design and Analysis of Buried Culverts, 1976). Improved soil models can have a very large effect on the reliability of the culvert load rating.

In the linear-elastic soil-structural model, a single modulus of elasticity and Poisson's ratio is used throughout the soil mass. At the very best, the modulus may be stratified with depth. In the non-linear soil-structure model, the soil stiffness can be increased not only with depth but also varied with the stress history. The result is a more reliable picture of the soil behavior. For the increase in sophistication, namely a shift from linear-elastic to non-linear soil models, the reliability for culvert load rating should improve.

### 6. *General, Three-Dimensional, Linear-elastic, Structural Models*

Sophistication of models increases as these models move from the two-dimensional realm, where the culvert slabs are modeled as beam-like slices, to the three-dimensional realm, where the culvert slabs are modeled as plates. By nature, the three-dimensional models are finite-element models. The simplest of the three-dimensional models is, unsurprisingly, the linear-elastic structural model. This model uses linear-elastic finite plate elements to model the culvert, springs to model foundation support and AASHTO equations to directly load the culvert. It is basically a three-dimensional expansion of the two-dimensional, linear-elastic, structural model.

Though there is a significant increase in sophistication, this model is still based on AASHTO loading guidelines. Therefore all the conservatism inherent in the AASHTO assumptions remains. The only real improvement is the way slabs carry loads differently from beams. The one situation where this makes a difference is in direct contact culverts. In this case the model would allow for consideration of some edge effects. But for deeper fill culverts this improvement is lost in the AASHTO assumptions.

Second, the mechanics of plate behavior are far less understood than beam behavior, especially for the typical structural engineer. Therefore, moving into a plate model rather than a beam model introduces uncertainties, both real and perceived, that decrease the suitability of this model.

Third, finite-element plate models require convergence studies to ensure that the proper mesh has been applied to predict the desired value. This highlights a situation where an increase in model sophistication can actually result in a decrease in confidence and reliability. For this reason, this model is not well suited for the purposes of culvert load rating.

7. *General, Three-Dimensional, Non-Linear, Structural Models*

The three-dimensional, structural model with non-linear material models is the next step in modeling sophistication. If the linear-elastic equivalent was considered appropriate for culvert load rating, the non-linear model would only be a marginal and unutilized improvement over the linear model. As it is, the three-dimensional, non-linear, structural model suffers from all the same pitfalls as its linear-elastic cousin. The increase in sophistication can lead to a decrease in reliability.

8. *General, Three-Dimensional, Linear-elastic, Soil-Structural Models*

The eighth model is a generalized, three-dimensional, linear-elastic, soil-structural model which uses plate elements to model the culvert and linear-elastic continuum elements to model the surrounding soil. This provides excellent soil-structure interaction and three-dimensional live load distributions. The increased sophistication of this generalized model can achieve significant increases in reliability over less sophisticated models.

9. *General, Three-Dimensional, Non-Linear, Soil-Structural Models*

The general, three-dimensional, non-linear, soil-structure model is the most sophisticated finite-element model available. It improves upon the three-dimensional, linear-elastic, soil-structure model by upgrading the material models from linear-elastic to non-linear. This takes into consideration soil-structure interaction, soil and structural behavior as it varies with stress history, edge effects, three-dimensional live load distribution and slab behavior. As the most sophisticated model, it should, given the proper inputs, closely predict the behavior of a load test. It is expected to give the most reliable results.

10. *Models Appropriate for Culvert Load Rating*

Of the nine classes of models available for soil-structure modeling, Table 3.2 summarizes the six models that are worthy of further consideration for culvert modeling and load rating. Note that models three, six and seven have been excluded because they do not yield an appreciable increase in reliability despite an increase in sophistication and in the effort needed to specify and apply the model.

TABLE 3.2. SUMMARY OF CULVERT APPLICABLE MODELS

MODEL #	GENERAL (GEN) / CULVERT (CULV)	TWO DIMENSIONS (2D) / THREE DIMENSIONS (3D)	LINEAR-ELASTIC (LE) / NON-LINEAR (NL)	STRUCTURAL (STRUC) / SOIL-STRUCTURAL (S-S)
1	CULV	2D	LE	STRUC
2	GEN	2D	LE	STRUC
4	GEN	2D	LE	S-S
5	GEN	2D	NL	S-S
8	GEN	3D	LE	S-S
9	GEN	3D	NL	S-S

The models in Table 3.2 are listed in increasing rank by sophistication and anticipated reliability. In the next section, a value analysis will be made to determine which of these models are appropriate for production load rating and which lend themselves to research oriented analysis.

## 2. Value Analysis of Models

Though several types of models are available to load rate culverts; not all models may be useful to the engineer for production load rating. A production engineer's primary concern is achieving the necessary reliability with the least effort. Therefore an exploration of the balance between reliability and ease of use would be helpful. The categories of evaluation include reliability, inputs, general use and load rating specific use. In this section, each model will be qualitatively assessed in each category and then analyzed to determine which models are appropriate for load rating.

### 1. Degree of Sophistication and Assumed Reliability

The engineer would prefer the most reliable model available if all other things are equal. Qualitatively, the three-dimensional, soil-structure models will have the highest sophistication and highest anticipated reliability (H). Two-dimensional soil-structure models will have average or medium reliability (M). Two-dimensional structural models will have lowest anticipated reliability and sophistication (L). Table 3.3 shows the qualitative ratings.

TABLE 3.3. QUALITATIVE EVALUATION OF MODEL SOPHISTICATION AND RELIABILITY

MODEL #	GEN / CULV	2D / 3D	LE / NL	STRUC / S-S	QUALIATIVE SOPHISTICATION / RELIABILITY
1	CULV	2D	LE	STRUC	L
2	GEN	2D	LE	STRUC	L
4	GEN	2D	LE	S-S	M
5	GEN	2D	NL	S-S	M
8	GEN	3D	LE	S-S	H
9	GEN	3D	NL	S-S	H

### 2. Identification of Input Variables

The identification of input variables is important because it directly influences production readiness of a particular model. This category will be broken into three sub-categories: the number of variables needed, the ease or difficulty associated with identifying those variables, and the required confidence in the variables indentified.

#### 1. Number of Variables

All models use the same sort of structural material properties such as thickness, strength, modulus of elasticity, reinforcing, etc. Even the variables used in non-linear structural models are generally well agreed upon in the structural world and thus require no further mention.

The primary issue is the soil parameters. The least sophisticated models require no soil parameters while higher models may require as many as a dozen variables associated with three-dimensional, non-linear soil models. The fewer the number of required variables, the more desirable the model is. Therefore, qualitatively, models with very few soil parameters have the highest desirability (H). A model with an average number of soil parameters, such as in linear-elastic finite-element models, is moderately desirable (M). A model with many soil variables will be the least desirable (L).

## 2. Ease of Variable Determination

Beyond the number of variables required, the models should also be scored based upon the ease or difficulty of determining the variables. Reasonable values for some soil variables can be found in reference books. Other variables require expensive and time-consuming laboratory or field tests to represent the materials.

Again, this variable can be qualitatively rated in terms of high (H), moderate (M) and low (L) desirability. Models requiring less expensive and less time consuming preparatory test are the most desirable. The highest desirability models (H) have variables whose values can be easily determined from reference materials. Models which require some sort of correlated in-situ testing are only moderately desirable (M). The least desirable models (L) require costly and time-consuming field and lab testing to determine variable properties.

## 3. Required Confidence in Variables

It is also important to evaluate the degree of confidence associated with each variable. This is really an issue of model sensitivity. Structural models are generally well understood and, relative to demand calculations, these models are unaffected by changes in individual variables. This sort of insensitivity to variable inputs, relative to model ease of use, is highly desirable (H). However, finite-element programs can be very sensitive to various input parameters, and therefore require greater confidence in those parameters. This means that in terms of variable confidence, finite-element models are less desirable.

Table 3.4 summarizes the anticipated qualitative performance of the culvert applicable models in the realm of variable identification.

TABLE 3.4. QUALITATIVE EVALUATION OF MODEL INPUT VARIABLES

MODEL #	GEN / CULV	2D / 3D	LE / NL	STRUC / S-S	NUMBER SCORE	EASE SCORE	CONFIDENCE SCORE	VARIABLE TOTAL
1	CULV	2D	LE	STRUC	H	H	H	H
2	GEN	2D	LE	STRUC	H	H	H	H
4	GEN	2D	LE	S-S	M	M	L	M
5	GEN	2D	NL	S-S	L	L	L	L
8	GEN	3D	LE	S-S	M	L	L	L
9	GEN	3D	NL	S-S	L	L	L	L

### 3. Model Generation Ease of Use

The next category is the ease with which the model can be built in individual programs. The most highly desirable models (H) in terms of ease of model generation will undoubtedly be the culvert specific models. These models take the most basic geometric properties and automatically construct the model. The moderately desirable models (M) allow for graphical model generation. The least desirable models (L) require extensive input file writing to build the model. Model generation in non-graphical models can be extremely difficult and time consuming.

Table 3.5 shows the ease of model generation for the various models.

TABLE 3.5. QUALITATIVE EVALUATION OF EASE OF MODEL GENERATION

MODEL #	GEN / CULV	2D / 3D	LE / NL	STRUC / S-S	MODEL GENERATION
1	CULV	2D	LE	STRUC	H
2	GEN	2D	LE	STRUC	M
4	GEN	2D	LE	S-S	M
5	GEN	2D	NL	S-S	L
8	GEN	3D	LE	S-S	L
9	GEN	3D	NL	S-S	L

### 4. Load Rating Specific Ease of Use

The final issue for consideration is the ease with which a particular model can be used for load rating. Load rating issues include the identification of critical sections, separation of dead and live load and the application of moving live loads.

#### 1. Identification of Critical Sections

When load rating, it is important to be able to accurately determine the demands at the critical sections. In many cases this is as simple as placing a node at the critical section. Some models then allow the user to filter the demands to select just those nodes; others require the user to identify the critical section demands from the output manually.

The highly desirable models (H) allow the user to identify and filter out the critical section demands automatically. Moderately desirable models (M) allow the user to identify the critical sections but require the user to isolate the demands manually from the output. The least desirable models have fixed outputs which require interpolation to identify the critical section demands.

#### 2. Separation of Dead and Live Loads

Another important step in the load rating process is identifying the dead and live loads separately. Some models provide totally independent dead and live load runs. These models are highly desirable (H). Other models require a dead load run, and then a dead plus live load run. The live load demand is then isolated by subtracting the dead load demand from the dead plus live load demand. Such models are only moderately desirable (M). Conceivably, a program could require two totally independent models for determining dead

and live load demands. In other words, the model would have to be built twice. This sort of model would be the least desirable (L). However, almost all modern modeling programs would not require this level of redundancy.

### 3. Moving Live Load Applications

The last load rating requirement is the ease with which a moving live load envelope solution can be determined. Some models automatically determine the moving live load solution by simply inputting a load pattern and path. As the ideal solution, these models are the most desirable (H). Other models require programming a set of load cases manually for each live load position and then determining the envelope solution manually. These models are only moderately desirable. The worst case would be a model which required not only separate dead and live load models, but also separate live load models for each live load position. Most programs do not require this much work, but if they did, they would be the least desirable models (L).

Table 3.6 qualitatively summarizes the load rating specific evaluation.

TABLE 3.6. QUALITATIVE EVALUATION OF MODEL LOAD RATING SUITABILITY

<i>MODEL #</i>	<i>GEN</i> / <i>CULV</i>	<i>2D</i> / <i>3D</i>	<i>LE</i> / <i>NL</i>	<i>STRUC</i> / <i>S-S</i>	<i>CRITICAL</i> <i>SECTIONS</i>	<i>DEAD</i> <i>VS</i> <i>LIVE</i>	<i>MOVING</i> <i>LIVE LOAD</i>	<i>LOAD</i> <i>RATING</i> <i>TOTAL</i>
1	CULV	2D	LE	STRUC	L	H	H	H
2	GEN	2D	LE	STRUC	H	H	H	H
4	GEN	2D	LE	S-S	H	H	H	H
5	GEN	2D	NL	S-S	M	M	M	M
8	GEN	3D	LE	S-S	M	H	M	M
9	GEN	3D	NL	S-S	M	M	M	M

## 5. Overall Suitability for Production Use

The ideal model for culvert load rating would perfectly represent reality (highest reliability), would require very little effort to identify the input variables, would automatically generate the model, and would provide output ideally suited for load rating. The most highly desirable models come close to this goal. However, engineers interested in production culvert load rating are often willing to sacrifice some reliability for faster, easier ways to obtain results. Any model which requires significantly more work to gain marginal increases in reliability is of very little interest to the production load rater. Such models might find use in specialized research applications, but are not ideally suited to culvert load rating on a day-to-day basis. Table 3.7 summarizes the qualitative assessment of the six models under consideration.

TABLE 3.7. SUMMARY OF QUALITATIVE EVALUATION OF MODELS FOR PRODUCTION LOAD RATING

MODEL #	GEN / CULV	2D / 3D	LE / NL	STRUC / S-S	SOPHISTICATION / RELIABILITY	VARIABLE IDENTIFICATION	MODEL GENERATION	LOAD RATING	TOTAL
1	CULV	2D	LE	STRUC	L	H	H	H	H
2	GEN	2D	LE	STRUC	L	H	M	H	M
4	GEN	2D	LE	S-S	M	M	M	H	M
5	GEN	2D	NL	S-S	M	L	L	M	L
8	GEN	3D	LE	S-S	H	L	L	M	L
9	GEN	3D	NL	S-S	H	L	L	M	L

Table 3.7 shows the more desirable models are two-dimensional and use linear-elastic material models. Two-dimensional models are easier to use than their three-dimensional counterparts and require far fewer variables with lower required variable confidence.

In contrast, the higher order models, despite their increase in sophistication and reliability, are less attractive for production load rating due to their need for more input variables, more complex model generation, and lower suitability to culvert load rating applications. Accordingly, the models that are well suited for production culvert load rating are:

1. Prepackaged, Two-Dimensional, Culvert Models
2. General, Two-Dimensional, Linear-Elastic Structural Models
3. General, Two-Dimensional, Linear-Elastic, Soil-Structural Models

These production-ready models are suitable for culvert load rating as defined by a measured balance of analytical effort and reliability. These are the models used in the *Culvert Rating Guide*.

## **5. DEVELOPMENT OF LEVEL 1 ANALYSIS: TWO-DIMENSIONAL, SIMPLY-SUPPORTED STRUCTURAL FRAME MODEL**

The purpose of this analysis level is to perform a quick and easy demand calculation using a prepackaged, two-dimensional, culvert specific model. The main reason for this analysis level is to include TxDOT's culvert analysis program CULV-5 in the *Culvert Rating Guide*.

### ***1. Model Construction***

Model dimensions are not needed to construct a model in CULV-5; rather this information is used to determine the location of the critical sections. Though AASHTO requires the identification of the worst-case critical midspan section, throughout the *Culvert Rating Guide*, the midpoint is used instead. This is a safe assumption due to the relative flatness of the moment diagram at this location and the already included conservatism of the production-ready models.

### ***2. Loads***

Applied culvert loads are dictated by AASHTO. CULV-5 uses influence lines to determine the application of live load. The magnitudes of the loads are calculated automatically.

The dead loads vary linearly with depth. However, the live loads vary non-linearly with depth. The live load distribution is based on AASHTO Standard Specifications for Highway Bridges Section 6 for culverts. The basic premise is that the load from a single wheel should be uniformly applied over an area equal to  $1.75 \cdot D$ . When the wheel areas for multiple wheels overlap, the total load is to be uniformly applied over the encompassed area. AASHTO specifies multiple presence factors when 3 and 4 or more trucks affect the load. Equations were derived for 1, 2, 3 and 4 or more trucks. For culverts with less than 2' of fill, the load is treated as a direct load with the appropriate impact factor according to an equivalent line load equation.

The AASHTO load geometries are shown in the following figure.



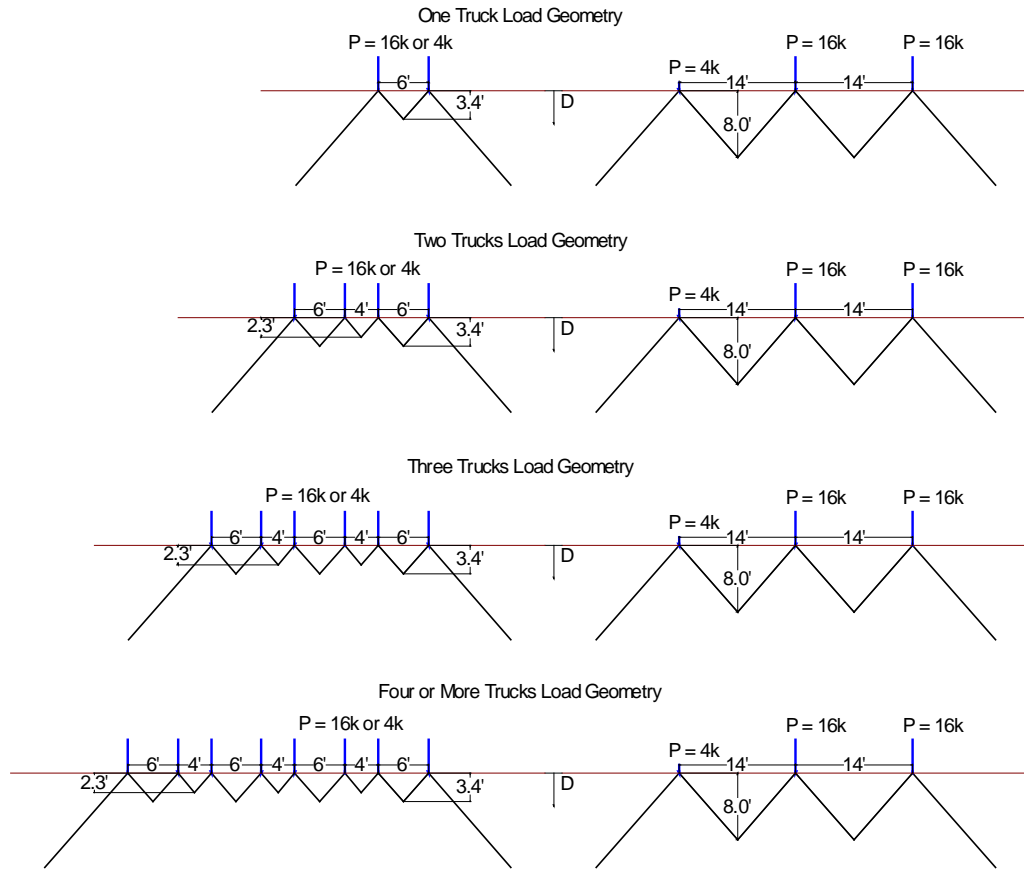

FIGURE 3.6. TWO DIMENSIONAL FRAME LOAD GEOMETRY

The live load pressures were developed from the load geometries. The worst case scenario was determined for each range by plotting the load factor as a function of trucks and depth. This plot is shown in Figure 3.7. This resulted in the step function outlined in the *Culvert Rating Guide*.

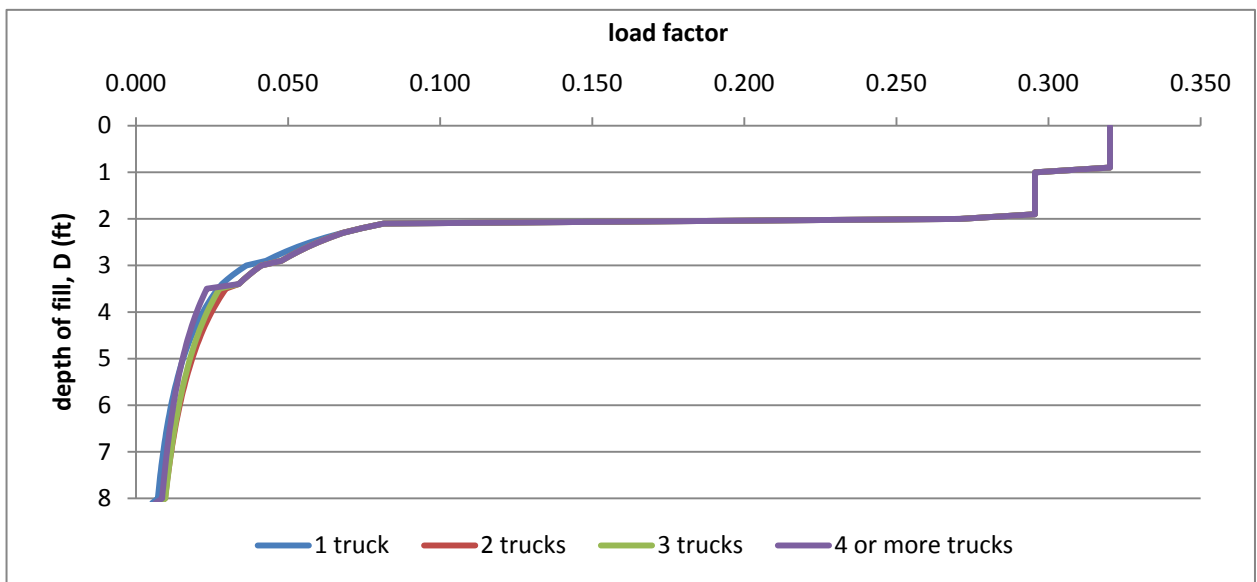

FIGURE 3.7. TWO DIMENSIONAL FRAME ANALYSIS COMPARISONS OF LIVE LOADS

### **3. Analytical Program – CULV-5**

The *Culvert Rating Guide* provides a step by step procedure for calculating the demand loads using CULV-5. The strengths and limitations are summarized from both the CULV-5 documentation and literature review. The step-by-step instructions guide the user through the process of creating the model and running the program, applying the load cases and determining demands, to calculating the rating factors and selecting the final inventory and operating load ratings.

### **6. DEVELOPMENT OF LEVEL 2 ANALYSIS: TWO DIMENSIONAL STRUCTURAL FRAME MODEL WITH SOIL SPRINGS**

Level 2 represents a slight modification compared to the Level 1 analysis. The general modeling assumptions, model dimensions, loads and load cases are the same between the Level 1 and Level 2 models. The main difference is the boundary conditions. Instead of a simply supported structure with balanced loads (Level 1), compression soil springs are used to model foundation support (Level 2). This level was introduced to take advantage of the capabilities of the more general frame models. CULV-5 is incapable of this level of analysis. Level 2 is the recommended first modeling step for those not using CULV-5.

RISA-2D is the non-CULV-5 tool of choice for TxDOT. Therefore, though the modeling instructions are written for any modeling program, specific instructions for RISA-2D are provided. These instructions include an overview, a summary of strengths and limitations, and a step-by-step procedure for creating the model and load cases in RISA-2D. This includes calculating the demands, load rating factors and inventory and operating load rating factors.

## 7. DEVELOPMENT OF LEVEL 3 ANALYSIS: TWO DIMENSIONAL FINITE ELEMENT SOIL-STRUCTURE INTERACTION MODEL

The Level 3 analysis is a significant change from the Level 1 and Level 2 analyses. In this model, AASHTO standard loadings are discarded in favor of a finite element method to model the behavior of the soil mass. In this way, the self-weight of the soil applies the dead load and the live load is applied as a point load on the soil surface and is distributed through the soil. The *Guide* provides an overview of assumptions and model dimensions. The boundary conditions include the size of the modeled soil mass. The size of this soil mass was selected from the guidelines provided by the defacto standard in two-dimensional culvert finite element modeling program, CANDE (Katona M. G., CANDE-a Modern Approach for the Structural Design and Analysis of Buried Culverts, 1976). The boundary conditions are set to model an infinite continuous soil mass.

### 1. Live Load Distribution

When using two dimensional finite element models, it is not necessary to distribute the live load through the soil to a pressure applied to the culvert frame elements as it is in the frame model. In the finite element case, the live load is applied to the surface of the soil and the finite elements translate and distribute the load in the in-plane direction by design. However, it is necessary when using a two dimensional finite element model to distribute the load in the out-of-plane direction. This can be done in several ways.

The first is related to the AASHTO *Standard Specification for Highway Bridges*. The method would be to take a point load and distribute it over a line that is  $1.75 \cdot D$  long. Like in the frame approach overlapping loads would be averaged over the total overlapping length.

The second is described in the CANDE-2007 Solution Methods manual and has been adopted by AASHTO LRFD. In this case the point load is distributed over a line which is  $1.15 \cdot D + H$  long where H is the length of the tire contact patch (20 in.).

The third approach is also described in the in the CANDE-2007 Solution Methods manual. It is a modified elastic approach. The length of the line is obtained from a complicated formula. Unlike the other two methods, this method does not take into consideration the presence of multiple wheel loads.

Like when determining the live load for the frame analysis, it is necessary to derive the load with respect to depth and number of trucks and then determine the worst case loading conditions. The derivation of the AASHTO *SSHB* method uses the same load geometries used in the Level 1 and 2 analyses shown in Figure 3.6. The AASHTO *LRFD* method uses a slightly different load geometry. This is shown in Figure 3.8. The elastic approach uses the Boussinesq stress distribution. Once the load functions were derived from the load geometries, the worst case loading was determined for each by plotting the load factor as a function of trucks and depth.

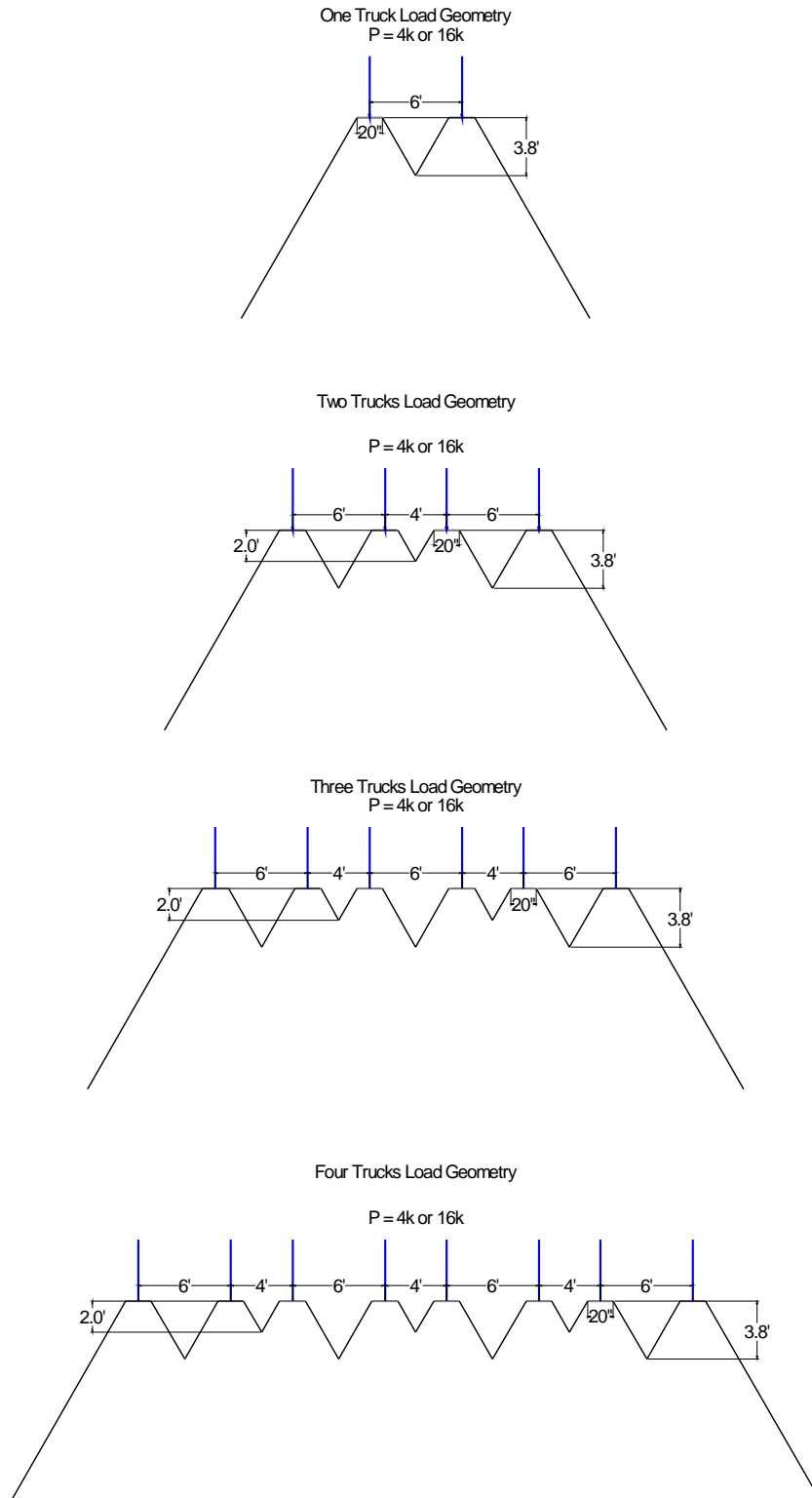

FIGURE 3.8. TWO DIMENSIONAL FINITE ELEMENT AASHTO LRFD LIVE LOAD GEOMETRY

Figure 3.9 shows a comparison of load distribution approaches. It is clear that for depths of less than eight feet, the elastic method is far and away the most conservative. It is also clear that except for a narrow band from two feet of fill to around three feet of fill, the AASHTO *SSHB* approach is the least conservative. Expert opinion and soon-to-be released

NCHRP reports indicate the AASHTO *LRFD* approach best represents “reality” with a comfortable balance between conservatism and accuracy. It is also convenient that the LRFD approach removes the discontinuity between the code equation of direct traffic loads ( $D < 2'$ ) and greater fill depths. Therefore, the AASHTO *LRFD* approach was adopted and included in the *Culvert Rating Guide*.

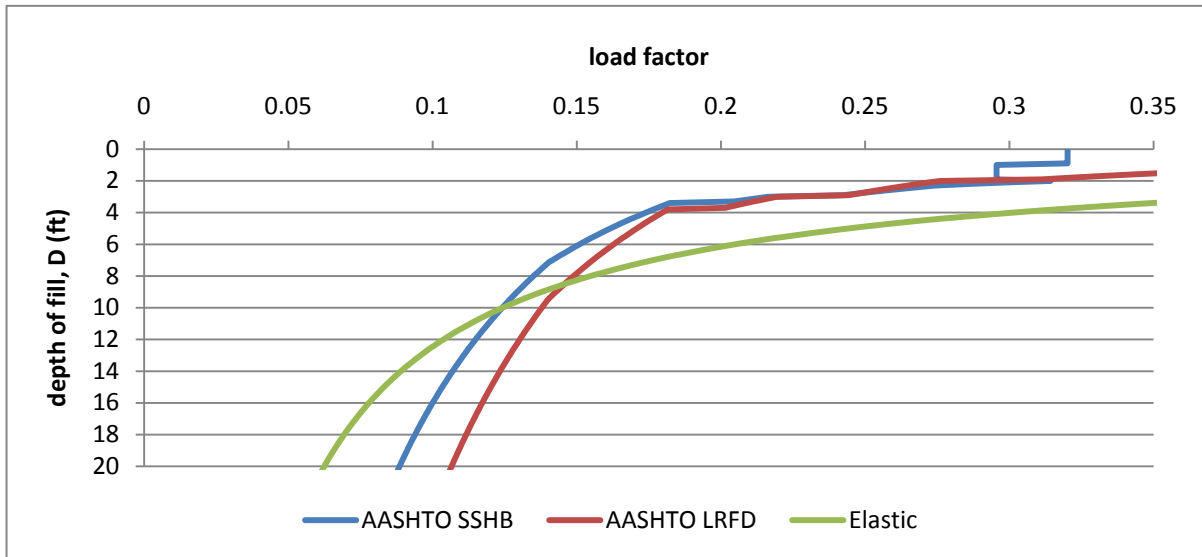

FIGURE 3.9. TWO-DIMENSIONAL FEA COMPARISONS OF LIVE LOADS

It is also worth noting that for soil-structure FEA models there is only one load case. The reduced lateral loading case specified by AASHTO only applies to direct stiffness models and has no meaning in a finite element model.

## 2. Production Load Rating Considerations

Two common programs are available for the Level 3 analysis. CANDE is the standard culvert finite element model. It is widely accepted as the culvert modeling tool of choice, particularly for dead loads. RISA-2D is a general frame analysis program capable of linear elastic plate modeling.

The advantages of CANDE-2007 are mainly in the inclusion of complex soil models, the use of improved concrete models that consider the effect of reinforcing steel, and in the provision of “canned” finite element meshes that facilitate specification of the analytical model in a user-friendly way. Further, CANDE has been extensively documented and as noted in Chapter 2, CANDE’s primary advantage is the 30 years of validation that has been done on the program.

Notwithstanding these impressive benefits, CANDE is not particularly user-friendly for production culvert load rating. This is primarily due to the asymmetrical nature of the wheel loads which must be applied for rating purposes, and the fact that these wheel loads must be manually programmed to “travel” across the culvert cross section in order to establish load envelopes for the culvert structure. The canned culvert meshes in CANDE cannot be used for this application. This means that the finite element mesh and wheel loads must be hand-

generated, a process that is very tedious and error-prone for users who are not familiar with the CANDE program.

Another challenge to using CANDE for culvert load rating arises from CANDE's use of a sophisticated nonlinear reinforced concrete model. This model establishes the structural capacity of the culvert slabs and walls, and when applied loads exceed the calculated member capacity, the culvert structure "fails." Culvert load rating, however, typically applies a standard load to the culvert per AASHTO policy, that is, an HS-20 truck. If the culvert is stout enough to support the HS-20 load, a properly-identified CANDE model will determine the culvert load rating. However, if the culvert does not have adequate capacity to support the HS-20 load, the culvert structure will fail. While this conclusively establishes one load that the culvert cannot carry, culvert load rating is about determining the load the structure can support. To achieve this objective, the load-rater must backtrack and resort to a trial-and-error process of manually reducing the applied load until the (weak) culvert does not fail.

These challenges for CANDE only exist when the objective is production culvert load rating. The effort necessary to create the model, generate the load conditions, and achieve a load rating with CANDE would not be at issue for other culvert analysis and design applications. But for production load rating of culverts by engineers who are not expert CANDE users, a more user-friendly approach would be desirable. RISA-2D is such a model. RISA incorporates a graphical user interface that can readily generate the finite element mesh for both the culvert structure and surrounding soil. The program also includes a feature that automatically applies a moving load across the culvert model to facilitate determination of the load envelope. In addition to ease of input, graphical output features are also excellent. Notwithstanding the user-friendly nature of the program, the pertinent question becomes, "Can RISA-2D provide valid results?" Stated another way, would the validity of results from RISA-2D approach the validity of results from CANDE?

Initial inquiry into this question revealed the following items:

- RISA-2D has very few of the powerful features of CANDE-2007. It can however model linear-elastic finite elements and it can create meshes and moving live loads very easily via the graphical interface. It does not have an improved concrete model like CANDE, but it does use a linear-elastic gross section property approach typical of the constitutive models still widely used for culvert load rating.
- In the case of load rating analyses for culverts which have been in the ground for a number of years and installation details may have been lost, it is appropriate to use a linear elastic soil model (Katona M. G., 2008).
- Some concern exists about the validity of RISA-2D, specifically, how it handles the finite elements. Soil-structure interaction problems like this, even with a linear-elastic soil model, approach the limit of RISA-2D's capabilities. One concern is that RISA-2D would not accurately model the interface between the soil elements and the beam elements.
- Exploration into this issue revealed that CANDE-2007 includes interface elements, but generally does not use them, but rather assumes a bonded condition between soil

and structure. Though this may not be appropriate for many soil structure systems, this modeling condition is usually conservative compared to going through the extra work of including interface elements. This holds particularly true considering the linear-elastic soil model that is being considered in this case (Katona M. G., 2008).

- The Whitney's ultimate capacity concrete model used in RISA-2D is very accurate. The typical cases were more complex concrete models are more valuable are when determining deflection or when confining steel is present. In the case of culvert load rating, neither of these factors comes into play. The more complex models also set an upper limit to the rating range. That is to say that the only valid load ratings are those which use a test truck which is smaller than the rating truck.

These observations show no *a priori* reasons why RISA-2D would not be an appropriate program for culvert load rating. Relative to validity, a test was developed to establish whether results from RISA-2D appropriately correspond to those of CANDE. Assuming that all other things are equal, if results from RISA-2D could be matched to CANDE to within 10% for moment, the research team felt it would be appropriate to use RISA for a Level 3 culvert analysis. CANDE could be used for correlating other models or for research-oriented load rating studies.

### ***3. A Simple Beam Model Comparison Between CANDE and RISA***

In order to determine if CANDE and RISA behave the same mathematically, a simple model was designed. This model was a simply supported beam, four feet in length, carrying two feet of "soil." In order to produce demands with similar precision (three significant digits), the beam was specified using a modulus of elasticity related to concrete with one inch by one inch dimensions. The "soil" elements were modeled using the low stiffness soil elasticity modulus, one inch wide but 12 kcf in self weight. Two meshes were developed, one using one foot square soil elements, and the other using six inch square elements.

Several lessons were learned from this experiment. First it was determined that eight or more finite elements are needed in between supports to correctly predict even the shape of the shear and moment diagrams. This arises from the way both programs translate element loads through the nodes only. Therefore, instead of translating the weight of the soil elements into a relatively uniform pressure along the beam, it resolves the load into an equivalent number of point loads at the node locations. For example, if only two elements are used (two foot square elements in this simple model), the shear and moment diagrams appear to behave as though they were loaded with a single point load at the center of the beam. This is clearly incorrect, and for this reason, it is appropriate to focus on the data from the model which used six inch square elements.

The next discovery is that CANDE's beam output is dependent upon the number of elements that make up the beam. This suggests that CANDE uses a true finite element model to determine the beam reactions. It was also found that the number of beam elements need not be greater than the number of attached soil elements.

The way CANDE deals with beam elements is different from the way RISA deals with them. RISA analyses are not dependent upon the number of subdivisions in the element. In

fact one beam element was all that was required. This is due to the fact that RISA uses a frame modeling approach which converts intermediate loads into equivalent fixed end reactions which are then input into the solution matrix. This means that while the CANDE model is sensitive to both the number of beam elements and the number of adjacent soil elements, the RISA model is only sensitive to the number of adjacent soil elements.

Another modeling consideration is the culvert slice width. Originally the comparison assumed both models to be one inch wide. This is a requirement in CANDE. However in RISA, any width is possible. This is helpful because for 2D culvert rating analyses, the width of the culvert slice is typically assumed to be one foot. Comparison of a one-inch wide RISA model with a one-foot wide model converted into similar units showed that both models produced the same results.

When comparing the predicted moments, shears and thrust between the RISA and CANDE programs, it was found that they matched very closely (see Figure 3.10). For moments, the differences were less than 10%. For axial loads, differences were less than 25%. For shear in the mid-span, the differences were acceptably slight. However, near the supports, shear did not match as closely as desired. The shape of the shear diagrams for the two models were similar. Both approaches seem valid and they are reasonably close.



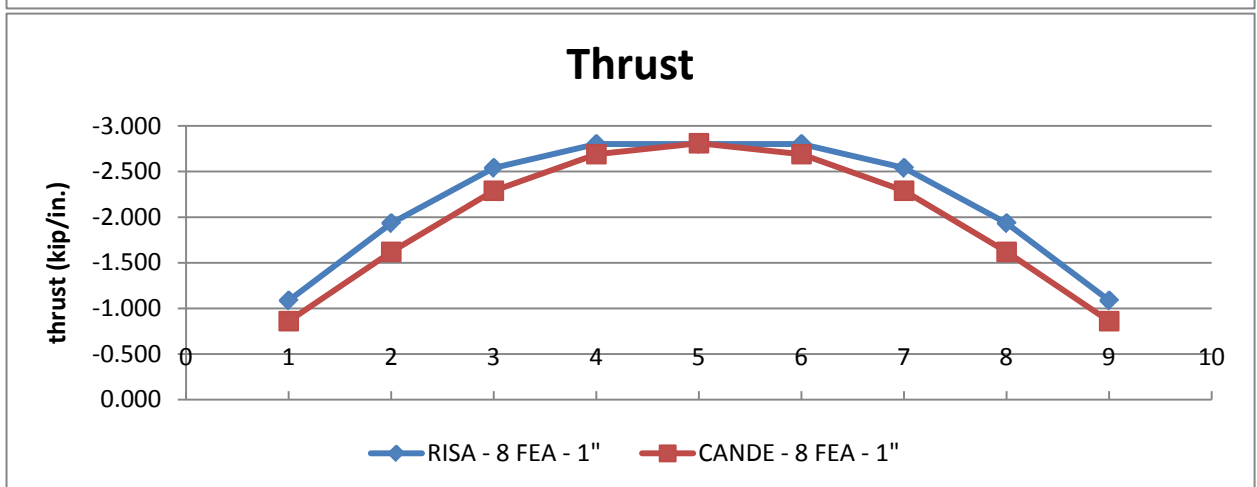
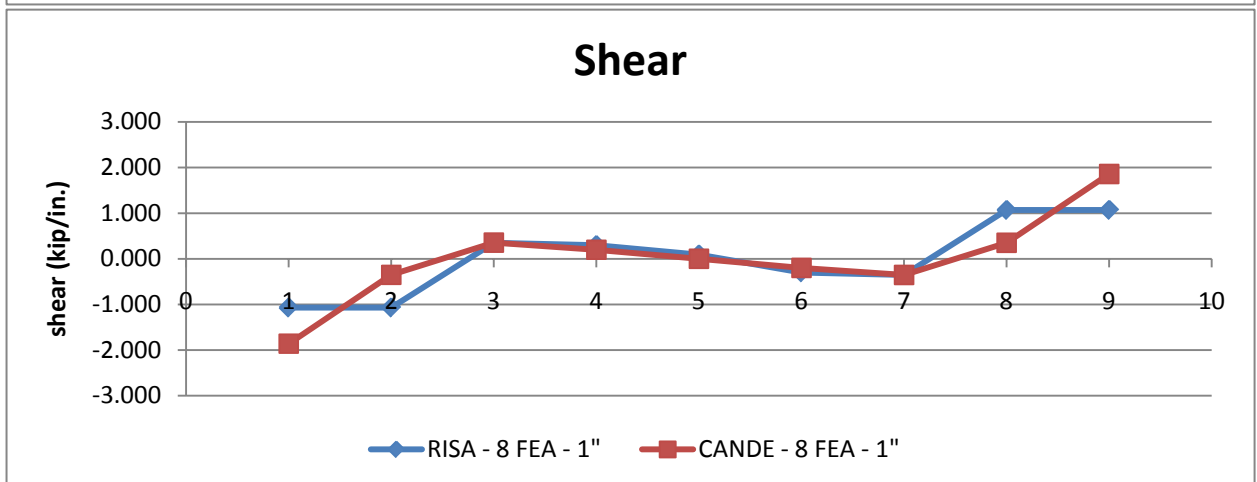
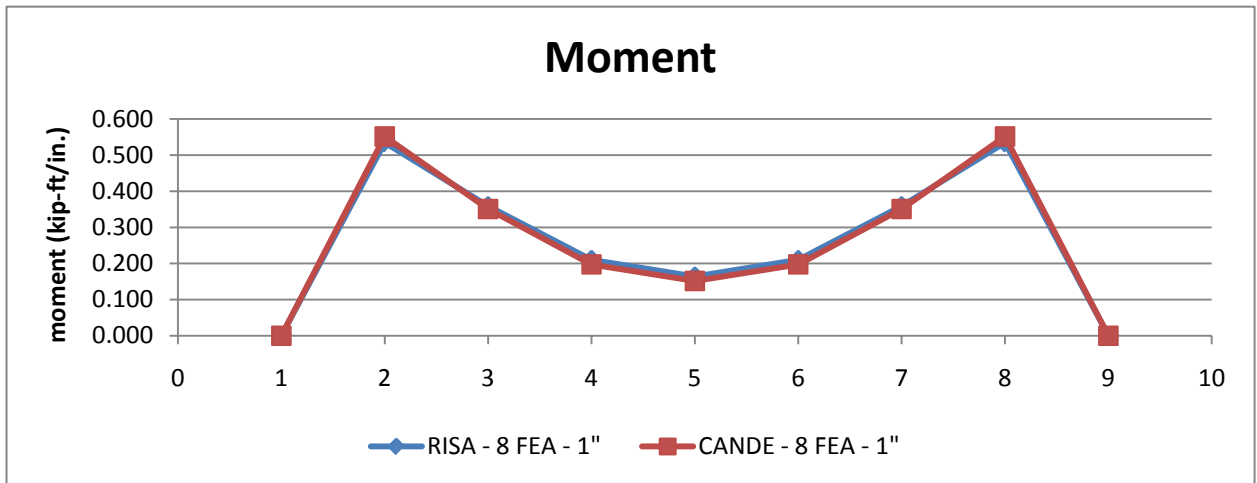

FIGURE 3.10. DEMANDS FROM SIMPLE BEAM MODEL COMPARISON.

#### 4. Full Culvert Model Comparison Between CANDE and RISA

To further evaluate consistency between the CANDE and RISA models, it was necessary to analyze a full culvert using both programs and compare the results. The culvert selected for this analysis was a two barrel culvert from sheet MC5-2, five feet wide and three feet tall per span.

This culvert-model test revealed more nuances concerning the similarities between RISA-2D and CANDE-2007. The most remarkable and important note is the sensitivity of these models to the number of soil elements adjacent to the culvert beams. The CANDE model only used six elements, while the initial RISA model used eight. This resulted in a 25 percent higher rating using RISA, highlighting the importance of this issue.

For comparison purposes, CANDE was first modeled using a linear elastic beam model. This is referred to as CANDE LEFE in the graphs. However, CANDE’s advantage over RISA is its advanced concrete model capabilities. When this was used, another problem emerged. CANDE refused to converge upon a solution. As seen in the linear elastic models, the test culvert for most soil qualities and models does not rate for an HS-20 truck. Therefore when CANDE attempts to “accurately” model the concrete, it finds that the concrete fails and “yields” without convergence. To work around this problem, the load was reduced to the truck weight represented by the CANDE LEFE model. This also leads to a more precise rating because CANDE does not follow a linear relationship and therefore, the linear assumptions in the load rating equations do not really hold. To properly rate a culvert using CANDE, the maximum size truck should be used to result in a load rating factor of 1.0. The resulting load rating factors are included in the following graphs as CANDE Advanced (uses advanced concrete model).

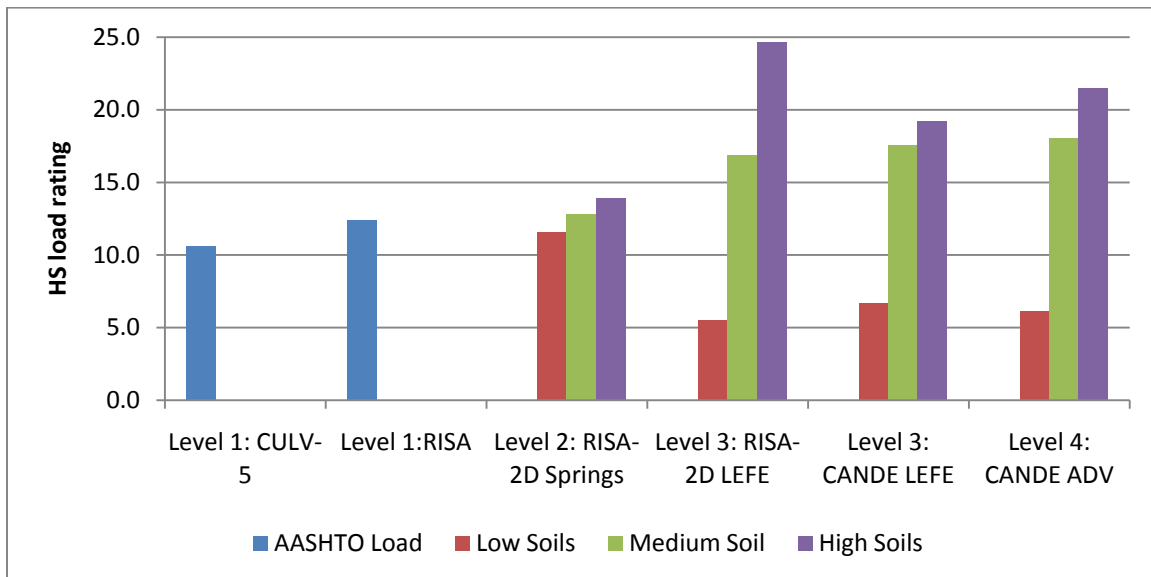

FIGURE 3.11. LOAD RATING COMPARISON OF FULL SCALE CULVERT

Figure 3.11 shows the comparison of load ratings determined by the different analytical models. For purposes of this analysis, it should be noted that the RISA and CANDE models

produce similar rating trends. Results from CANDE using the full array of its concrete models are lower than results from RISA because of CANDE's nonlinear analysis approach.

When trying to determine whether RISA and CANDE yield similar results, it is more helpful to compare the moment ratings from similarly meshed models (Figure 3.12). This figure shows that a RISA model with essentially the same mesh as the CANDE model produces essentially the same load rating.

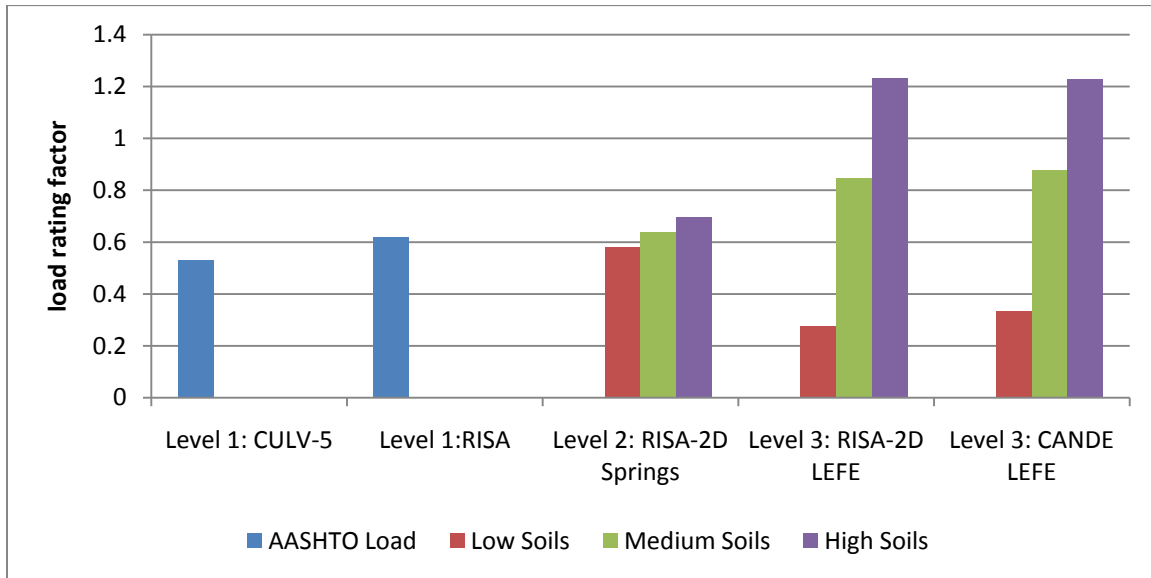

FIGURE 3.12. MOMENT RATING OF FULL SCALE CULVERT

### 5. *RISA-2D as the Level 3 Analysis Program of Choice*

RISA-2D and CANDE handle linear elastic finite element modeling of moment and deflection in essentially the same ways. Some discrepancy occurs in the calculations of shear and thrust, but these rarely control in culvert applications. The lessons learned during this comparison between RISA and CANDE are:

- Eight or more “soil” elements must be used along each culvert slab or wall to get similar results
- RISA-2D may be under-conservative when calculating shear
- For problem culverts which rate at less than HS-20, CANDE may not provide a solution when using the advanced concrete models
- Culvert analyses using CANDE’s advanced concrete models must use a truck load equal to the rating to produce an accurate rating.

For TxDOT’s culvert load rating applications, this research indicates that RISA-2D and CANDE-07 do provide similar results for moment ratings. By virtue of its production-ready capabilities and in particular, its user-friendly graphical user interface, RISA-2D emerges as the program of choice for Level 3 analytical modeling.

Therefore, the *Culvert Rating Guide* identifies RISA-2D as the Level 3 model, and provides step-by-step instructions to construct a model, set boundary conditions and load cases, and determine the demands using RISA-2D with linear elastic finite elements. The *Culvert Rating Guide* provides a straightforward overview of the issues associated with using finite element modeling. It also discusses the strengths and limitations of the RISA-2D program for modeling a linear elastic finite element soil-structure system.

## 8. COMMENTARY ON THE CULVERT RATING GUIDE

The following paragraphs provide a commentary on development of each chapter of the *Culvert Rating Guide*.

### 1. Chapter I: Introduction

The introduction to the *Culvert Rating Guide* discusses the purpose, history, scope and philosophy of the *Guide*. The purpose of the *Culvert Rating Guide* is the purpose of this research endeavor; that is, to articulate a clear, reliable procedure for the load rating of culverts. This section also introduces the AASHTO definition of a load rating as the largest truck load permissible on a structure either indefinitely (the inventory rating) or limited use (operating rating) (AASHTO, 2003).

The history of culvert design in TxDOT highlights design eras and unique design information, in particular, design philosophies and the problematic Texas Highway Department Supplement No. 1. This information derives from a thorough investigation of TxDOT reinforced box culvert designs archived by the TxDOT Bridge Division.

The scope of the *Culvert Rating Guide* was limited by the Project Monitoring Committee to include the load rating of in-service, cast-in-place, reinforced concrete box culverts with drained backfill and adequate visual inspection condition. The principles in the *Culvert Rating Guide* have limited applicability to other culvert types and conditions but must be applied with caution and engineering judgment.

The philosophy of the *Culvert Rating Guide* summarizes the load rating process as a comparison of capacity, dead load demand and live load demand. The capacity is determined using AASHTO specifications. The dead and live load demands are determined using an analytical modeling approach which uses analytical tools of escalating complexity, difficulty and accuracy.

### 2. Chapter II: Policy Requirements

It has been noted that the Project Monitoring Committee established that the policy which must be followed for culvert load rating is found in the AASHTO *Manual for Condition Evaluation of Bridges* (AASHTO, 2003) and *Standard Specifications for Highway Bridges* (AASHTO, 2002). Whereas historic TxDOT practices for culvert load rating sometimes differs from AASHTO policy, the *Culvert Rating Guide* requires that AASHTO policy must be satisfied.

The AASHTO *SSHB* defines three failure modes, critical sections, and total and reduced lateral load cases. A unique interpretation of these policy requirements is defined explicitly in the *Guide* in order to avoid confusion. An analysis approach which considers the cross sectional slice of the culvert as a two dimensional model is also explicitly described and is typical in structural analysis practice. The rating variables as defined by AASHTO *SSHB* and *MCEB* are also explicitly defined and interpreted. The *MCEB* rating equations are also reiterated and defined.

### **3. Chapter III: Culvert Load Rating Procedure**

Load rating is one portion of the larger culvert inspection process. The third chapter of *Culvert Rating Guide* puts load rating into context and outlines the overall load rating procedure. The load posting and visual inspection context of the culvert load rating process are governed by TxDOT's *Bridge Inspection Manual*, AASHTO's *MCEB*, and the Federal Highway Administration's (FHWA) *Culvert Inspection Manual* (AASHTO, 2003; FHWA, 1986; TxDOT, 2002).

The complexity of the culvert load rating process is illustrated using the flow chart reprinted as Figure 3.2 in this report. The *Culvert Rating Guide* also emphasizes the concept of economy of work versus sophistication of analysis when selecting an analytical model and the importance of quality control, review and checking of load rating calculations and the oversight of a Licensed Professional Engineer.

### **4. Chapter IV: Culvert Details**

Chapter four of the *Culvert Rating Guide* leads the engineer through the process of collecting the pertinent data needed to load rate a culvert. The section on units discusses the typical units used to describe culverts. Culvert dimension variables are defined and given symbolic nomenclature. The structural material properties, such as steel and concrete, are discussed. These data can be taken from the standards or plan sheets, collected from tests on field samples or from steel quality control tickets, or assumed to be the values provided by AASHTO *MCEB*.

The section dealing with soil properties addresses soil unit weight, modulus of subgrade reaction, Poisson's ratio, and modulus of elasticity. The simplest of the soil parameters is the unit weight, with this value controlled by the AASHTO *SSHB*.

The modulus of subgrade reaction used in the second level analysis can be determined by correlation based on soil classification of the bearing soil for the culvert. The *Culvert Rating Guide* presents a table of typical values selected from pavement and beam-on-elastic-foundations texts. Alternatively, this parameter can be established through field tests.

Soil input parameters for the third level of analysis include soil modulus and Poisson's ratio. The parametric analysis discussed in Chapter 5 in this report indicates that the culvert load rating is not particularly sensitive to Poisson's ratio.

The soil modulus of elasticity is a highly important variable for the Level 3 analysis. The load rating varies widely based on this parameter. A table showing typical modulus ranges and recommended values based on soil classification is provided. This table was derived from a collection of published geotechnical and pavement resources. The *Culvert Rating Guide* recommends that the modulus be verified in the field. Based on the field test portion of this project, the falling weight deflectometer is recommended for validating the soil modulus.

The next section of chapter four outlines the nomenclature for discussing the steel reinforcing schedule. This is fairly normal for the discussion of doubly reinforced concrete beams and slabs.

The last section of chapter four discusses the culvert installation method. AASHTO manuals discuss this variable at length, though not articulately. In general, it is believed that the installation method only affects the early age behavior of the culvert. For load rating of older, in-service culverts, the installation method can be ignored.

### **5. Chapter V: Culvert Capacity Calculations**

Calculation of the culvert capacity is dictated by policy. The first section of this chapter identifies the applicable policy sections from the AASHTO *SSHB*.

The second section articulates the unified sign convention for the *Culvert Rating Guide*. The bending sign convention was developed according to typical structural standard for the top midspan. This convention was applied throughout the culvert in relationship to the inside and outside of the culvert, rather than the typical top and bottom tensile faces. The sign convention in the *Culvert Rating Guide* states that for positive bending, the tension face is inside the culvert (*i.e.*, for the top midspan the bottom surface is in tension). When the tension face is outside the culvert, bending is negative (*i.e.*, for the top midspan the top surface is in tension).

The third section outlines a generalized procedure for determining the capacities for the critical sections in the culvert. Though not all the equations shown in this section are included in the *SSHB* they are all derived from the code.

### **6. Chapter VI: Analytical Modeling for Demand Loads**

The sixth chapter is the heart and soul of the *Culvert Rating Guide*. The first section provides an overview for the rest of the chapter. The analytical modeling philosophy starts with the models which are the easiest to use and have the most conservatism, and then moves to more complex models with less conservatism. The demand calculation process for culvert load rating is significantly less defined than the capacity calculations. Again, guidance exists in the AASHTO policy, in particular Section 6 of the *SSHB*, but it gives the engineer much more leeway. The AASHTO *SSHB* specifies a soil unit weight, equivalent fluid weight and live load distributions through the soil. It does not specify the type of model that should be used or specifically how to apply the loads to the models. Because of this, great care must be taken when constructing a model, and every model-specific assumption should be noted.

The second section of this chapter provides a generalized process for determining demands. This procedure determines the demands and then uses the previously calculated demands to determine load rating factors and select the controlling load rating.

The third section of the chapter provides special guidance for when shear controls. The generalized approach to culvert load rating assumes that moment controls, and this typically is the case. However, if shear controls the code allows for a less conservative shear critical

section, as well as a demand-dependent shear capacity. This section provides a step-by-step procedure for applying these more complicated shear provisions.

The remaining sections of this chapter provide specific guidance for performing demand calculations using three different models of increasing model sophistication. When developing the *Culvert Rating Guide*, all possible models were considered and evaluated to determine production readiness.

### **7. Chapter VII: The General Analytical Model for Culvert Load Rating**

In this chapter, a Level 4 analysis is defined. More sophisticated models, or models which are not production oriented, may be used to further refine the culvert load rating. The *Culvert Rating Guide* makes it clear that a Level 4 analysis is used only in specific cases. Usually such a load rating will not be economically feasible for production rating of culverts. This chapter also discusses the differences and advantages between two-dimensional and three-dimensional models. CANDE-07 is the recommended program for a Level 4 two-dimensional analysis. Other generalized programs can be used for three-dimensional analysis.

### **8. Chapter VIII: Limitations**

Chapter eight of the *Culvert Rating Guide* includes specifically articulated limitations for using the *Guide*. These limitations are generally bounded by the limitations of the validation process. These include the culvert type, fill depths, backfill drainage conditions, soil parameters and analytical models. The guiding force in determining the scope of applicability was driven by the perceived needs of TxDOT as articulated by the project monitoring committee.



## 9. VALIDATION OF THE CULVERT RATING GUIDE

The *Culvert Rating Guide* was written in several drafts with critical reviews, both informal and formal, conducted on each version. Having articulated TxDOT's recommended practices and procedures for culvert load rating, the research focus was directed toward validating these practices and procedures. This involved three distinct research activities.

First, the *Culvert Rating Guide* was applied to a statistically representative sample of 100 of TxDOT's 1477 unique culvert designs. Chapter 4 of this report presents this research effort.

Second, a parametric study was performed to evaluate six independent variables associated with culvert load rating. Chapter 5 of this report presents the parametric analysis.

Third, the research team instrumented and load tested three in-service culverts in the field. This work facilitated a comparison of measured demand moments to predicted values obtained through analytical modeling as per the *Culvert Rating Guide*. Chapter 6 of this report presents this research effort.

Taken together, these three research tasks explore the breadth of application, sensitivity of expression, depth of correlation of the culvert rating practices and procedures in the Culvert Rating Guide relative to the full population of TxDOT's reinforced concrete box culverts.



## 4. LOAD RATING 100 TxDOT CULVERT DESIGNS

### 1. OVERVIEW

This chapter reports research findings from load rating a statistically representative sample of 100 TxDOT culvert designs. The research team performed this work with several objectives in mind, including:

- Confirm that the load rating procedures in the *Culvert Rating Guide* are clear and repeatable.
- Verify that the load rating procedures in the *Culvert Rating Guide* can be applied to the full population of TxDOT culvert designs.
- Determine whether load rating results for a broad sample of TxDOT's culvert designs cohere with the intuitions and experiences of TxDOT engineers who work with culverts on a daily basis.
- Identify characteristics of “problem” culverts
- Test the hypotheses that analytical models with increased sophistication will produce increased load ratings.

Load-rating 100 culvert designs provided a broad evaluation of the efficacy of the *Culvert Rating Guide* relative to production load rating of TxDOT culverts. The following sections of this chapter present the findings.

## 2. METHOD

### 1. Sample of 100 Representative Culvert Designs

TxDOT's culvert inventory includes 13,192 in-service culverts, constructed between 1905 and 2008, as shown in Figure 4.1. The TxDOT culvert design archives reflect 1477 unique designs on 73 standard box culvert design sheets. Culvert design has evolved throughout TxDOT's history. TxDOT archives reveal four eras of culvert design, each representing substantively different design approaches. These are the 1938 era, the 1946 era, the 1958 era, and the 2003 era.

Culvert designs from the 1938 era were designed using slightly unconservative earth loads, lower truck loads, but overly-conservative concrete construction that resulted in very durable culverts. The 1938 collection consists of 428 different culvert designs representing a diverse range of span lengths, number of spans, and barrel heights. Fill depths typically range from 0 to 6 feet.

During the mid-1940s, principally when the Farm-to-Market road system was being constructed, new culvert designs (59 total) were added to the body of 1938 designs. The 1946 era culverts were issued under the less conservative structural codes of the Texas Highway Department Supplement No. 1. These designs resulted in culverts which generally perform well, but which are not as robust as culverts designed per current AASHTO standards.

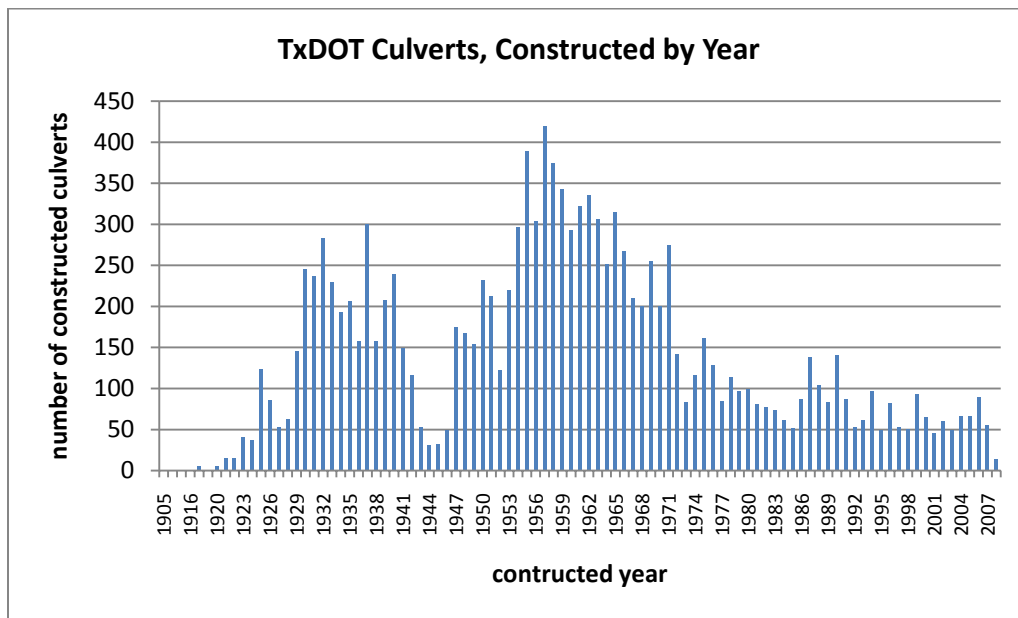

FIGURE 4.1. TXDOT'S AS-BUILT CULVERT POPULATION

In 1958, coincident with the advent of the Interstate Highway System, TxDOT redesigned and reissued their full set of culvert construction drawings. The 1958 set consists of 380 designs representing a diverse range of span lengths, number of spans, and barrel heights, with fill depths from 0 to 6 feet. The 1958-era designs use slightly less conservative soil loads but more conservative structural considerations and HS-20 truck loads.

The most recent era of culvert designs dates from 2003. Once again TxDOT redesigned, expanded, and reissued their complete set of culvert construction drawings. The 2003 set consists of 610 culvert designs, including new designs for deep fill culverts with fill heights up to 23 feet. Culvert designs for the 2003 era are based on current AASHTO policy.

For this study, 100 culvert designs were selected to statistically represent the full population of TxDOT culverts. In sample selection, consideration was given both to the diversity of culvert designs and the characteristics of the as-built culvert population.

### 1. Weighted by Era

Because of the importance of era, the 100 sampled culvert designs were selected with consideration to the number of designs in an era and the number of culverts actually constructed. Figure 4.2 shows the percentage of designs, the percentage of constructed culverts and the percentage of the 100 culvert sample corresponding to each era.

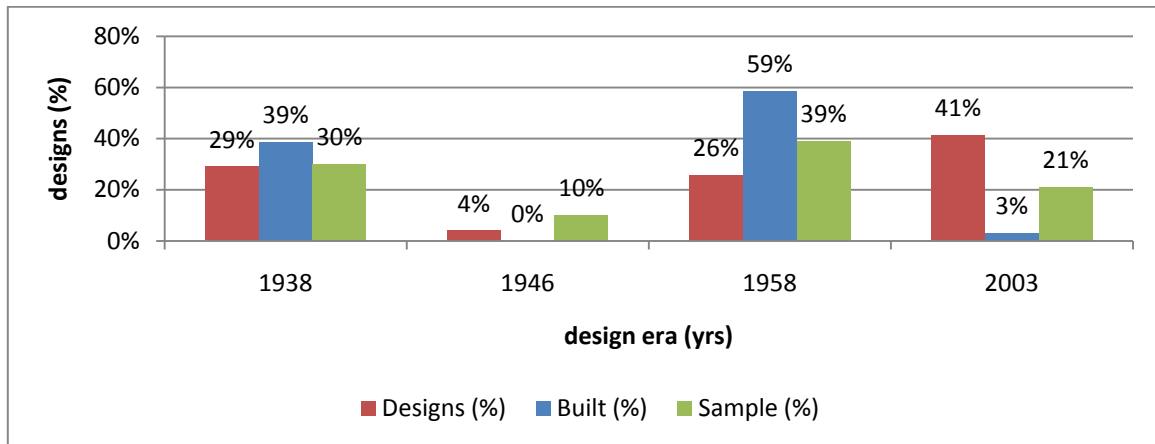

FIGURE 4.2. CULVERT DESIGNS VS BUILT VS SAMPLE BY DESIGN ERA

Allocation of the 100 culvert sample to the different design eras was accomplished as follows:

- 1938 era – 30 culverts. This number is representative of both the percentage of culverts built and the percentage of designs. These culverts typically are not problematic from a load-rating perspective.
- 1946 era – 10 culverts. As-built culverts of the 1946 era are included with the 1938 era statistic. TxDOT personnel identified culverts from this era as problematic relative to load rating. This era was oversampled to reflect their concerns.
- 1958 era – 39 culverts. The selected number of culverts is roughly the average of the percentage of designs and the percentage of constructed culverts. Because the majority of Texas’ in-service culverts were built in this era, it was felt that this era needed to be more heavily sampled.
- 2003 era – 21 culverts. Though very few culverts have been built in the 2003 era, this is the era with the most designs. It is also unclear when these designs will be

updated, so this design era may continue for the next twenty years or more. Therefore, it was appropriate to analyze several designs from this era in an effort to consider not only culverts that have been constructed, but those that will be built.

Having allocated the 100 culvert sample to the four design eras, this set the stage for stratified sampling relative to other key culvert variables.

## 2. *Representative by Variable*

The full population of culverts was sorted by independent variable, and the sample was randomly selected to represent the population. Besides design era, there are four distinguishing and important culvert design variables. These are the number of spans, the box length, the box height and the depth of fill. A stratified sort by these variables achieved the sample of 100 culverts which is representative for all variables.

### 1. Number of Spans

It is important to consider the number of spans in a multi-barrel box culvert. It is anticipated that single span culverts will experience greater stress than equivalent multi-span culverts. Multi-span culverts should have reduced moment, at least in the top and bottom slabs, because of the effect of continuous slab support. Figure 4.3 shows the percentage of culvert designs, constructed culverts and sampled culvert designs for each era.

### 2. Length of Spans

Another unique culvert variable is the length of the individual spans. This variable should be well represented from short spans to very long spans. Figure 4.4 shows the distributions for the length of span for each era.

### 3. Height of Box

The height of the culverts is another important variable. Perhaps, only the tallest boxes will experience significant bending in the wall mid-span, but the whole range of heights should be considered. Figure 4.5 illustrates that the sample distribution, though not perfectly matching the culvert design distribution, does cover the whole range of box heights.

### 4. Depth of Fill

The last culvert variable is the maximum design depth of fill. Depth of fill is important because of its direct effect on the ratio of the live load demand to the dead load demand (this ratio is the essence of load rating). When the depth of fill is low, the dead load demand is low while the live load demand is high. When the depth of fill is high, the live load becomes nearly negligible and dead load dominates. At intermediate fill depths, the effect of dead and live load is split. Therefore, it is crucial to match ranges of depth of fill in the sample to the ranges in the culvert design population. Figure 4.6 shows the distributions in each design era.

Figure 4.2 through Figure 4.6 show that the sample of 100 culvert designs is an accurate representation of the total population of TxDOT culvert designs by era. Results and trends detected for the sample of 100 culverts will therefore indicate trends in the whole culvert population.

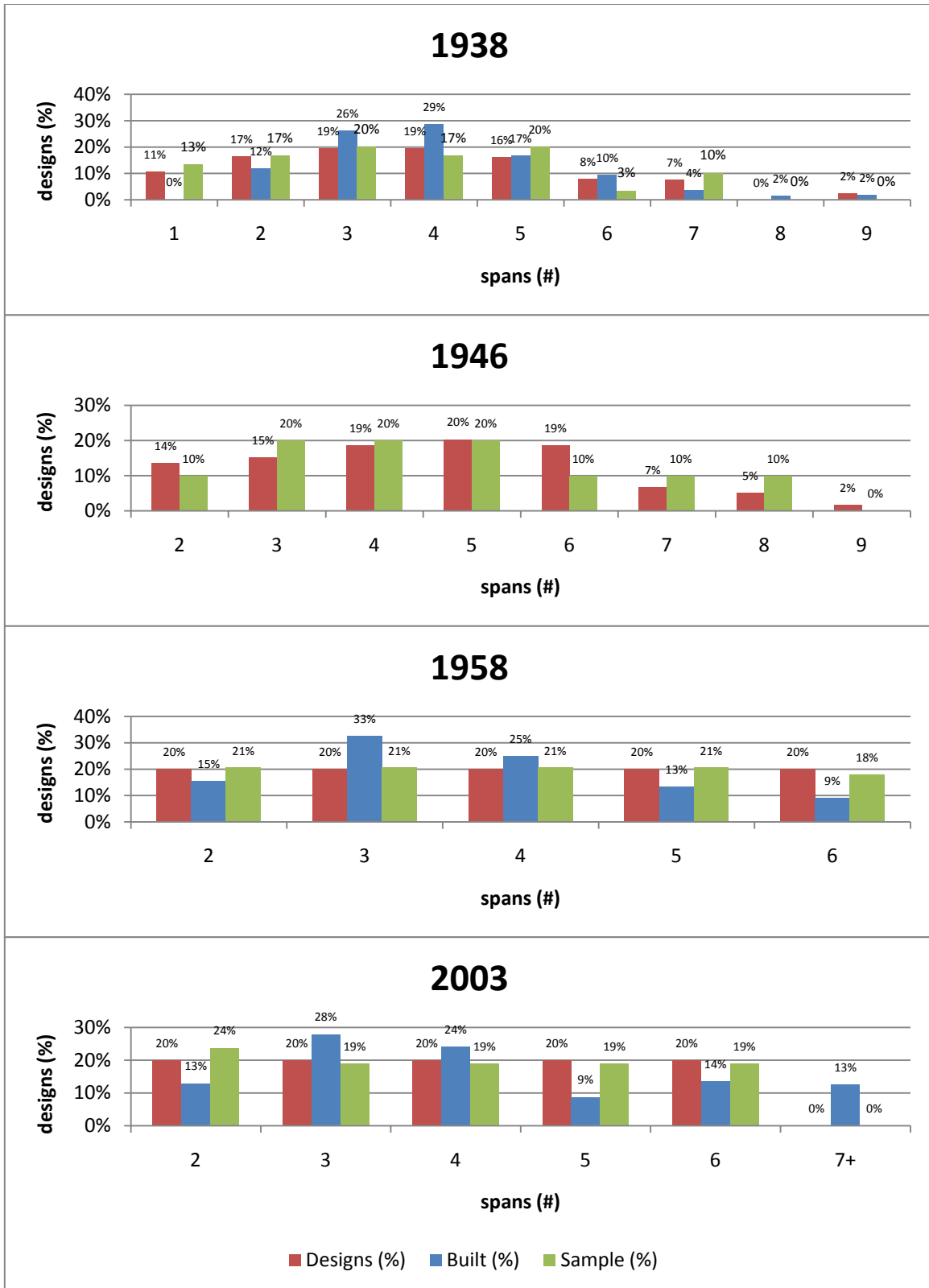

FIGURE 4.3. DISTRIBUTION OF THE NUMBER OF SPANS FOR DESIGNS, BUILT AND SAMPLE POPULATIONS





FIGURE 4.4. DISTRIBUTION OF THE LENGTH OF SPANS FOR DESIGNS, BUILT AND SAMPLE POPULATIONS

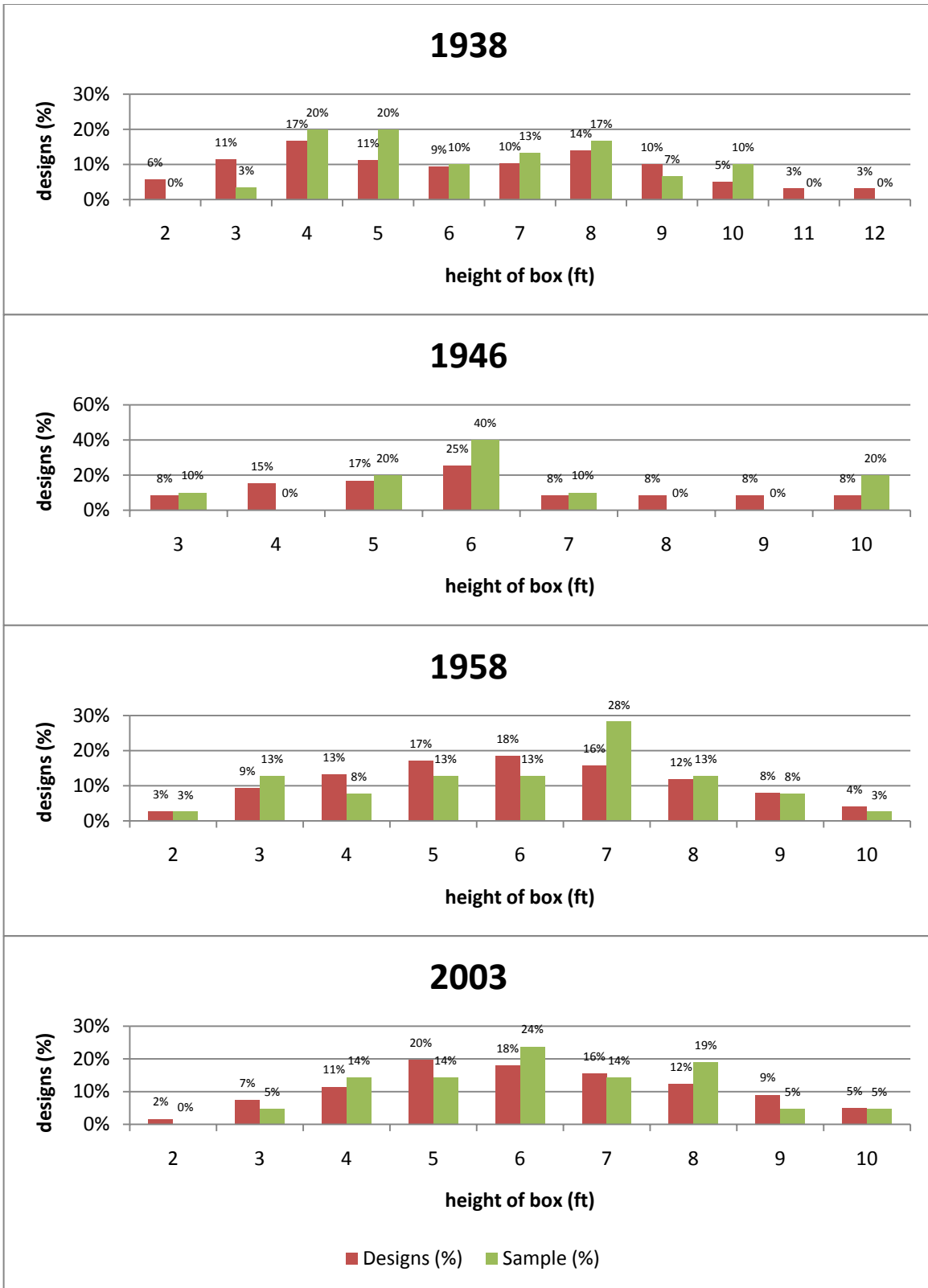

FIGURE 4.5. DISTRIBUTION OF BOX HEIGHTS FOR DESIGNS AND SAMPLE POPULATIONS

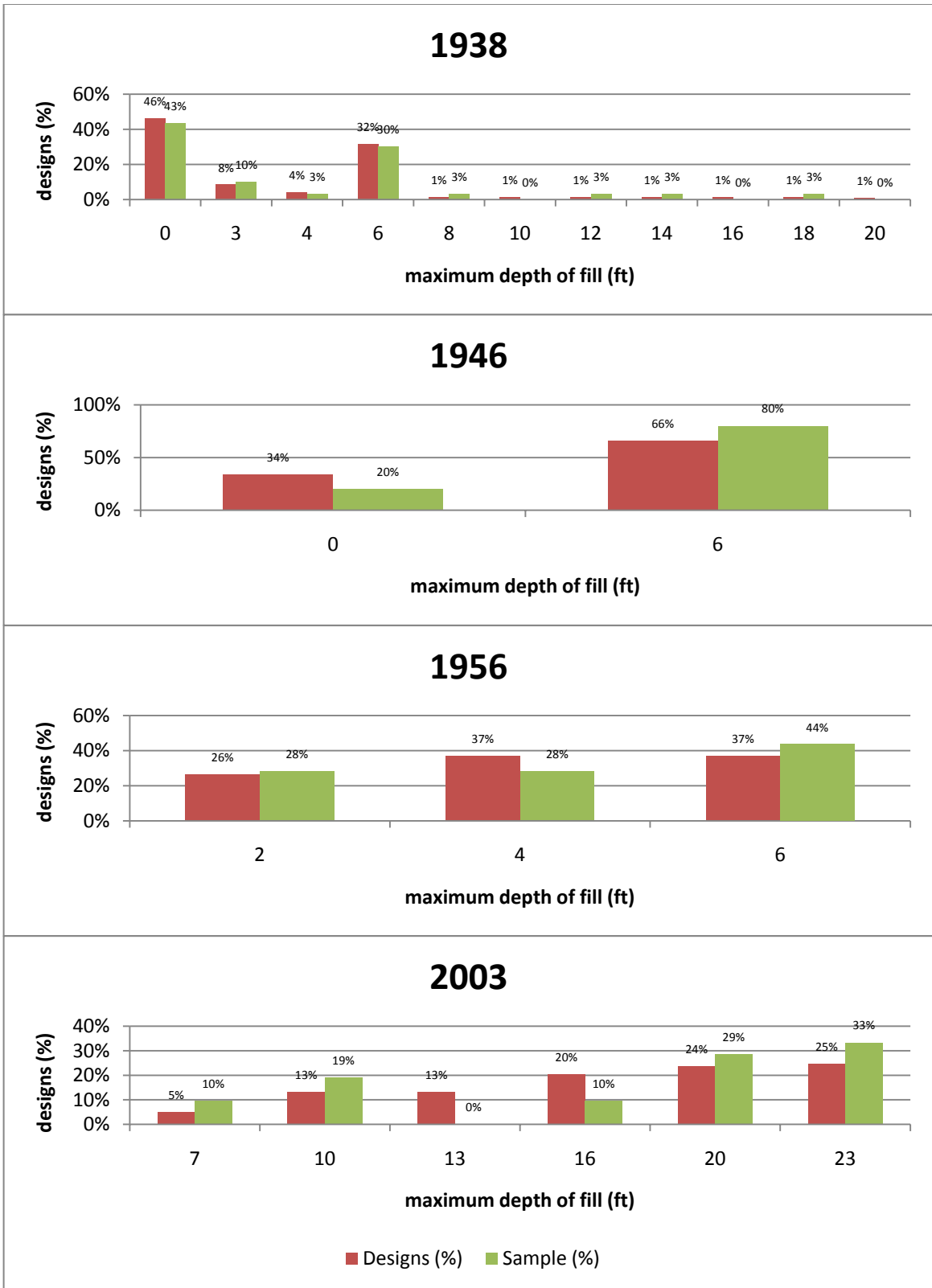

FIGURE 4.6. DISTRIBUTION OF MAXIMUM DEPTH OF FILL FOR DESIGNS AND SAMPLE POPULATIONS

## ***2. Application of Load Rating Method to Domains***

Each culvert design in the sample of 100 TxDOT culvert designs was load rated seven times following the procedures in the *Culvert Rating Guide*. The first load rating used TxDOT's prepackaged culvert analysis program, CULV-5, to calculate demands (Level 1 analysis). The next three load ratings used RISA-2D as a two-dimensional *structural* program. Each rating used a different value for the spring constant from the *Culvert Rating Guide*, hence the three ratings (Level 2 analysis). The final three load ratings were determined using RISA-2D as a two-dimensional, *soil-structural* program. Each rating used a different modulus of elasticity from the *Culvert Rating Guide* (Level 3 analysis).

The culvert load rating process yields inventory and operating ratings. To fully describe the nature of the ratings, the controlling critical section, failure mode (moment, shear or thrust) and load case (total or reduced lateral) must also be defined. This means that for a single culvert load rating, a total of 32 data points is produced: seven inventory load ratings, seven operating load ratings, seven controlling critical sections, seven controlling failure modes, and four controlling load cases.

### 3. LOAD RATING RESULTS FOR 100 CULVERT DESIGNS

#### 1. *Operational Statement and Hypotheses*

As noted in Chapter 1, it is expected that more sophisticated, production-ready analytical models produce more reliable load ratings for culverts. To test this concept, our research compared the results of seven load ratings per culvert, performed upon 100 representative designs for TxDOT cast-in-place, reinforced concrete box culverts, using CULV-5, RISA-2D with springs (structural model) and RISA-2D with linear-elastic finite elements (LEFE) (soil-structural model). The objective was to determine whether the two-dimensional soil-structural model produced a higher load rating than the two-dimensional structural model, which in turn should produce a higher load rating than the prepackaged culvert-specific model.

Modeling sophistication is what allows the load-soil-structure interaction portion of reliability to be identified and analyzed. The CULV-5 program (Level 1 analysis) does not model soil-structure interaction. Therefore, a high degree of conservatism must be included in this model to account for the uncertainties associated with load-soil-structure interaction. The RISA-2D with spring model slightly reduces some of this over-conservatism by considering the interaction between the foundation and the bottom slab (Level 2 analysis). RISA-2D with LEFE removes a great deal of uncertainty by modeling the whole load-soil-structure system in two dimensions (Level 3 analysis). Presumably, some over-conservatism still exists in the out-of-plane direction.

The hypotheses are designed to test the portion of reliability associated with load-soil-structure interaction as detected by model sophistication. Because uncertainty and over-conservatism are removed with each increase in modeling sophistication, it was expected that the load ratings would generally increase with increases in modeling sophistication.

The hypotheses for this study are:

*H-1.* RISA-2D with spring supports (Level 2 analysis) will produce a higher rating than CULV-5 (Level 1 analysis).

*H-2.* RISA-2D with LEFE (Level 3 analysis) will produce a higher rating than RISA-2D with springs (Level 2 analysis).

*H-3.* RISA-2D with LEFE (Level 3 analysis) will produce a higher rating than CULV-5 (Level 1 analysis).

#### 2. *Presentation of the Research Findings*

The results of the seven-fold load rating of the 100 culverts produced more than 3000 data points. To simplify presentation of this information, results will be considered by design era. This means that four sets of results will be presented, one per culvert design era. The direct relationship between inventory and operating ratings also simplifies the problem. These two ratings show exactly the same trends with only a coefficient difference between them. Therefore, only one plot for the dependent variable, in this case inventory rating, is needed. Appendices A through E include all the data in tabulated form by era; however, to

make trends easier to identify, this chapter presents the results in chart form. Five different classes of data are presented: (1) undifferentiated inventory ratings, (2) identification of statistically-significant culvert variables, (3) differentiated inventory ratings by significant culvert variable, (4) controlling failure mode, and (5) controlling critical section.

### *1. Undifferentiated Inventory Ratings*

The first plot will show the inventory ratings for all rated designs in the era. Results are sorted by analytical method ordered according to the expected increase in load rating: i.e. CULV-5, followed by RISA-2D with Springs using low, then medium, then high quality soil parameters, followed by RISA-2D with LEFE using low, then medium, then high quality soil parameters. Also included in this plot is the average of all the positive load ratings. A negative load rating means that the culvert fails under dead load, but the magnitude of negative load rating is essentially meaningless. The nature of the load rating equation makes it extremely sensitive to small live loads. A large magnitude negative rating may actually be closer to rating positively than a small magnitude negative rating. For this reason, negative live loads are neglected in the average calculation. The average allows trends to be identified more easily.

### *2. Identification of Statistically-Significant Culvert Variables*

The second set of plots show the inventory ratings compared to the various independent variables: depth of fill, box span, number of spans and box height. The coefficient of determination for each relationship is used to identify which independent variables directly affect load rating values. Those which are statistically significant are further evaluated.

### *3. Differentiated Inventory Ratings by Significant Culvert Variables*

The third set of plots presents the inventory ratings in terms of the analytical method but this time the plots are differentiated by significant variable. An average trend line is included in these graphs as well. This will allow for the identification of trends between models and the significant independent culvert variables.

### *4. Controlling Failure Mode*

The fourth plot presents the controlling failure modes: moment, shear or thrust. If multiple failure modes control, the plot differentiates between models. From these plots the most probable failure mode can be identified.

### *5. Controlling Critical Section*

The last set of plots shows the controlling critical section differentiated by significant independent variable. The controlling critical sections (Figure 4.7) are expected to change with analytical method. By comparing the critical sections to intuitive expectations, interesting trends may become obvious.

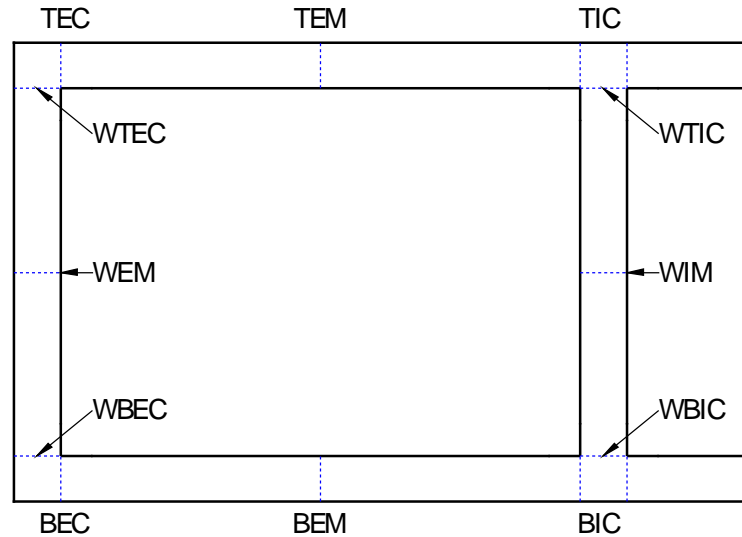

FIGURE 4.7. MOMENT CRITICAL SECTIONS FOR CULVERTS WITHOUT HAUNCHES.

Abbreviations for the typical critical sections shown in Figure 4.7, listed clockwise, are: top exterior corner (TEC), top exterior mid-span (TEM), top interior corner (TIC), top interior mid-span (TIM), wall top interior corner (WTIC), wall interior mid-span (WIM), wall bottom interior corner (WBIC), bottom interior mid-span (BIM), bottom interior corner (BIC), bottom exterior mid-span (BEM), bottom exterior corner (BEC), wall bottom exterior corner (WBEC), wall exterior mid-span (WEM), and wall top exterior corner (WTEC). For multiple-span box culverts, the sections are designated as per the culvert span; e.g., TIC1, TIC2, BIC1, BIC2, etc.

#### 4. 1938 ERA RESULTS

The 1938 era is the first complete set of TxDOT’s standard reinforced box culvert design sheets. The designs are typified by larger gross slab dimensions, lower strength materials and haunches. Though many culverts were originally designed for 15 ton trucks, because of the inherent conservatism in the older allowable stress design and material assumptions, many of these culverts perform very well, both analytically and in the real world.

##### 1. Undifferentiated Inventory Ratings

For the 1938 era, Figure 4.8 shows all the inventory ratings and an average trend line.

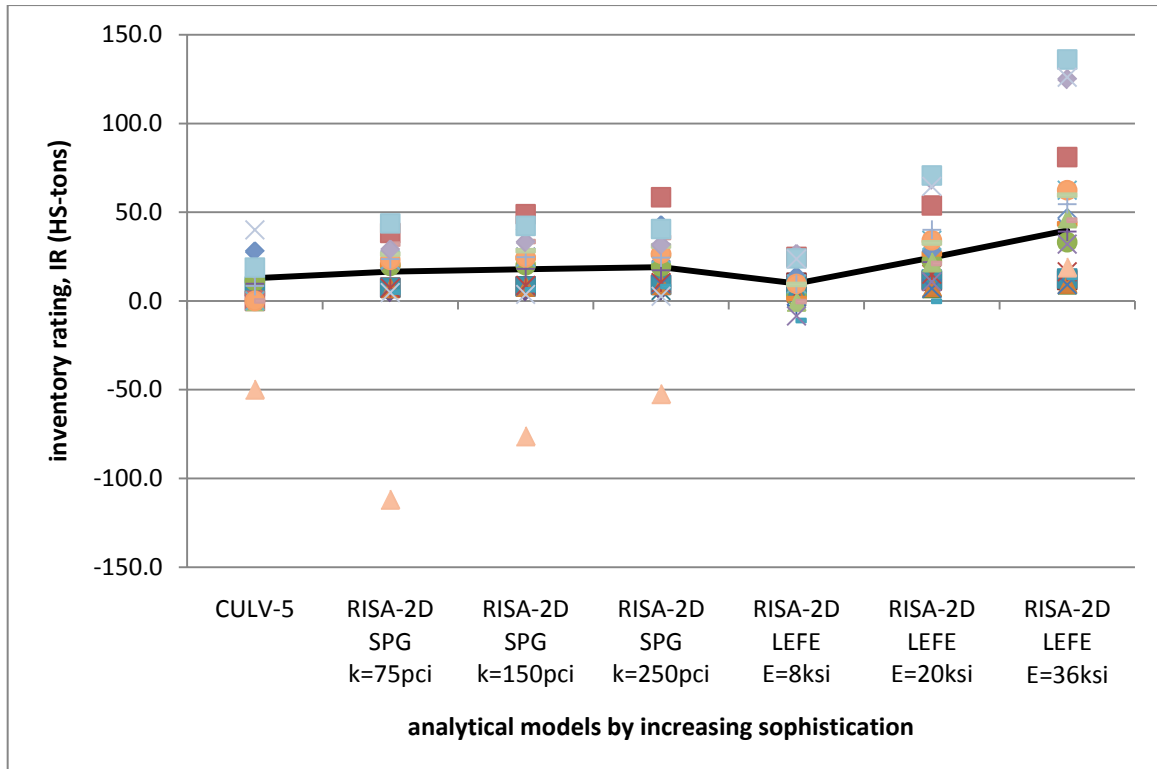

FIGURE 4.8. 1938 ERA INVENTORY RATINGS: UNDIFFERENTIATED

It appears that on average, the first hypothesis is supported. The load ratings from RISA-2D with spring-supports are just slightly higher than the CULV-5 ratings. Interestingly, the increase from CULV-5 to RISA-2D with springs is of the same order of magnitude as the increase from soft springs to medium springs and medium springs to stiff springs. The increase is small.

The second hypothesis is only partially supported by the whole of the 1938 sample. If the modulus of elasticity of the soil is high enough, an increase of load rating can be expected from RISA-2D with springs to RISA-2D of LEFE. However, for low stiffness soil, the calculated load rating using RISA-2D with LEFE tends to be less than the RISA-2D with spring analysis. The hypothesis is supported by the high and medium stiffness soils, but unsupported by low stiffness soils.



The third hypothesis is also only partially supported. For very stiff soils, the LEFE model produces higher ratings, but for soft soils, the load rating is lower than even CULV-5. RISA-2D with LEFE appears to be highly sensitive to the modulus value.

## 2. Identification of Statistically-Significant Culvert Variables

It is reasonable to ask, “Which independent variables affect the load ratings for a given sample of culverts?” This question can be answered by performing linear regression of the relationship between the independent variables and the actual inventory ratings. Figure 4.9 presents these results for the 1938 era along with the coefficient of determination for each variable.

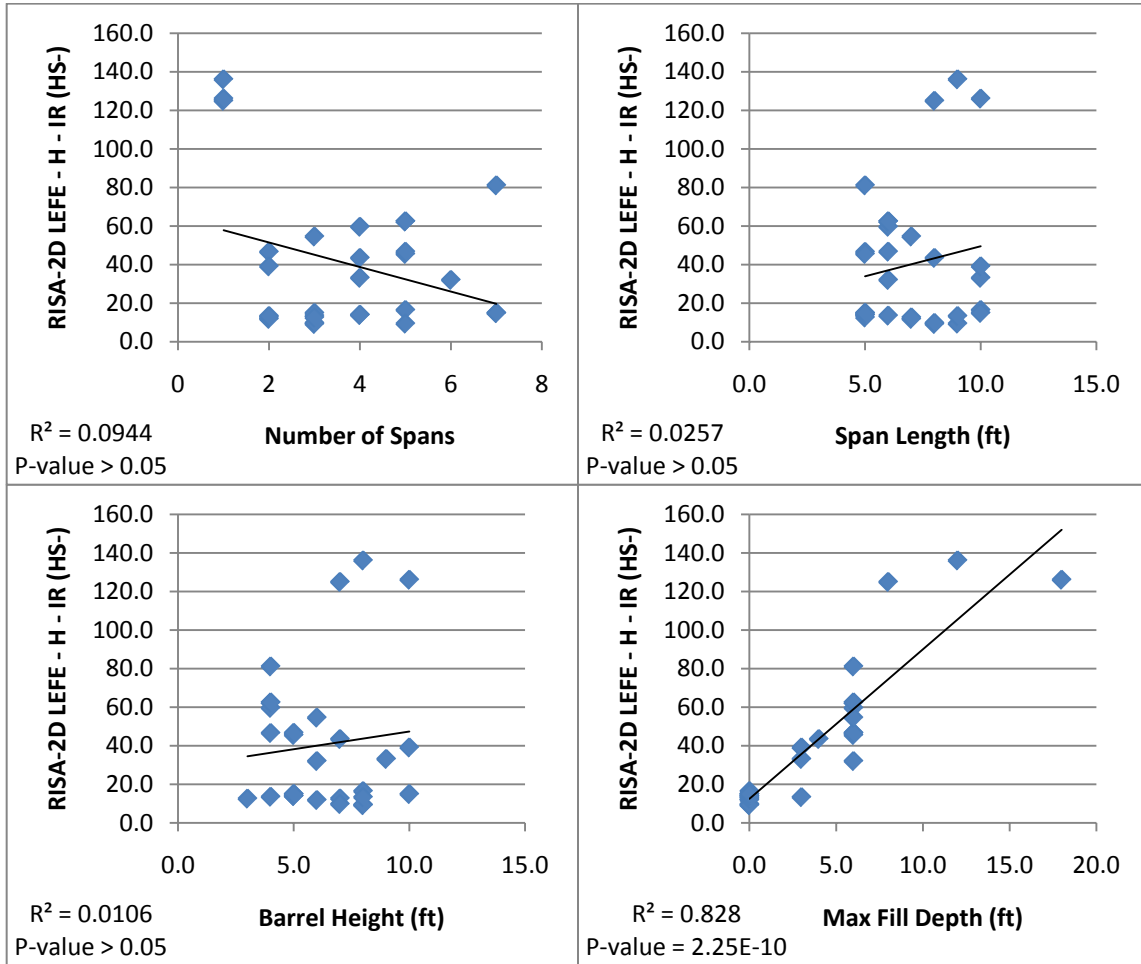

FIGURE 4.9. 1938 ERA STATISTICAL ANALYSIS FOR SIGNIFICANT INDEPENDENT VARIABLES

According to the linear regression analysis, the only significant variable for the 1938 era designs is the depth of fill. No statistically significant relationships exist between number of spans, barrel height or span length and the load rating. However, the relationship between depth of fill and load rating tends toward higher load ratings for higher depths of fill.

### 3. Differentiated Inventory Ratings by Significant Culvert Variables

Figure 4.10 shows the inventory ratings for direct traffic culverts – that is, those with no fill – in the 1938 era. In this subset, the first hypothesis is not supported. In this case, CULV-5 produces a higher rating than the all but the stiffest soil springs in the RISA-2D model. The second and third hypotheses are again only partially supported. For stiff soils, RISA-2D with LEFE produces a higher rating than RISA-2D with springs and CULV-5. However for low quality soils, the rating is lower.

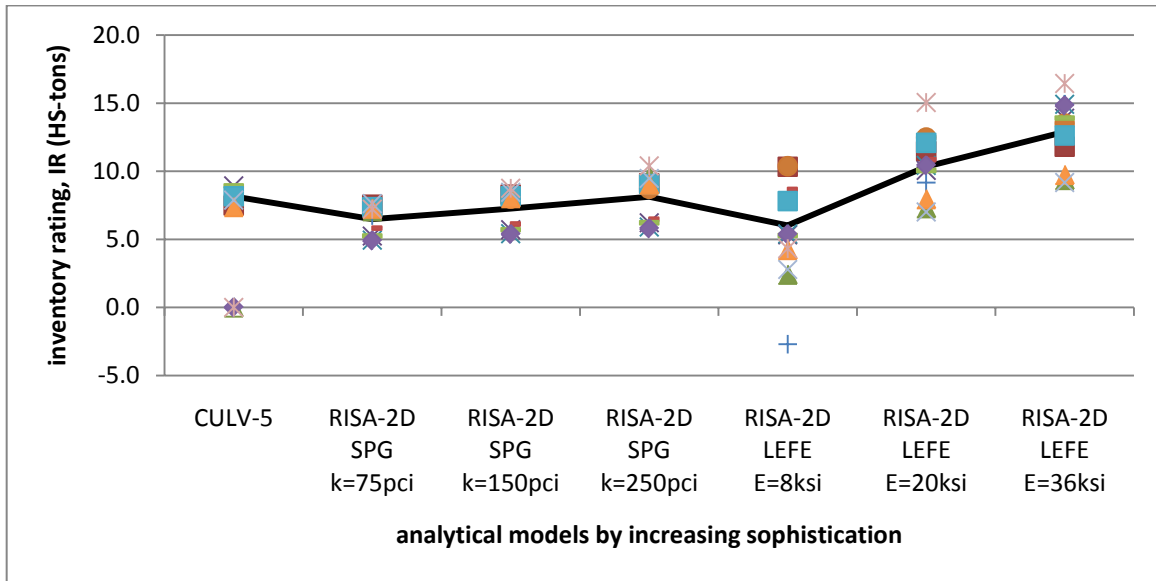

FIGURE 4.10. 1938 ERA INVENTORY RATINGS: DIRECT TRAFFIC

Figure 4.11 and Figure 4.12 show the inventory ratings for medium fill culverts. This subset supports the first hypothesis; RISA-2D with springs produces noticeably higher load ratings than CULV-5. Again the second and third hypotheses are only partial supported. For low soil stiffness the RISA-2D with LEFE produces lower ratings than the CULV-5 and RISA-2D with spring models. However, if the soil is stiff enough, the second and third hypotheses are supported.

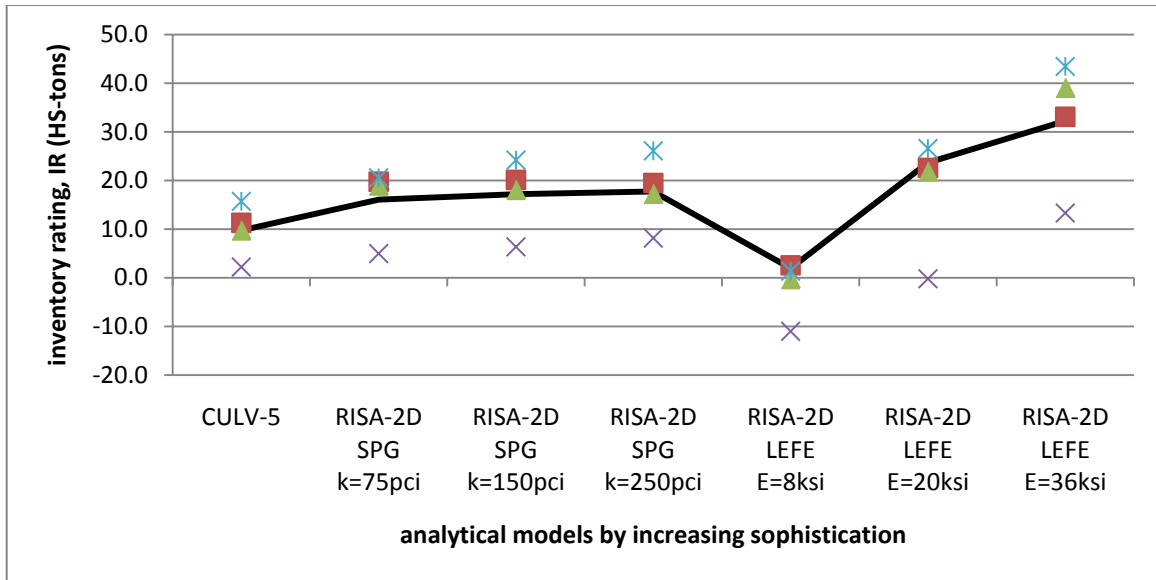

FIGURE 4.11. 1938 ERA INVENTORY RATINGS: 3' AND 4' OF FILL

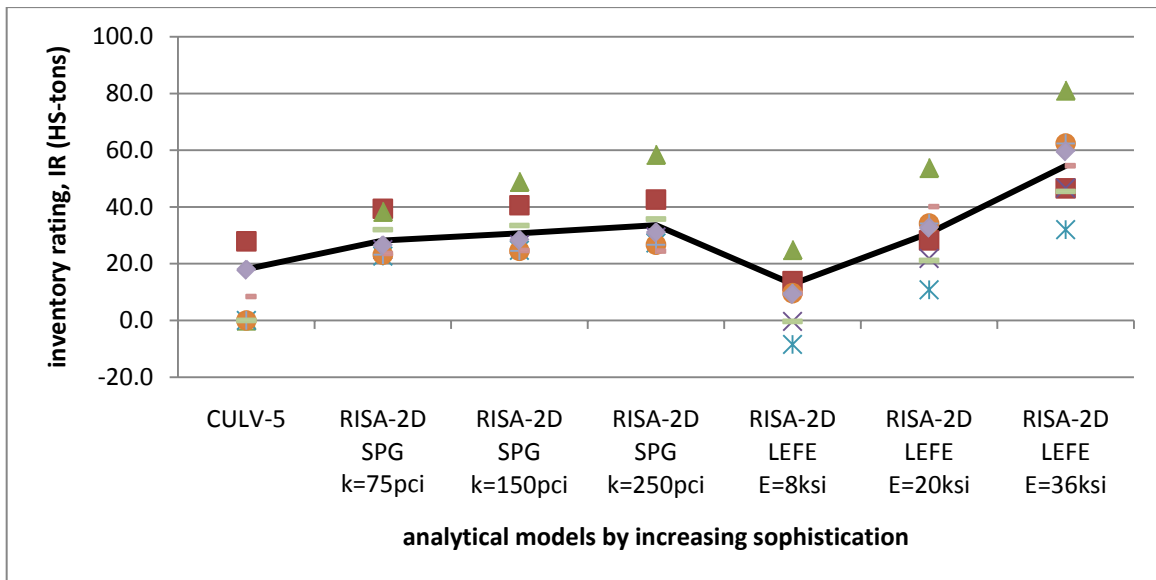

FIGURE 4.12. 1938 ERA INVENTORY RATINGS: 6' OF FILL

Figure 4.13 shows the inventory ratings for four deep-fill culverts. These are from a single sheet showing single barrel culvert designs. For these culverts, CULV-5 and RISA-2D with springs provide very similar ratings. The results are so close, in fact, that they cannot be said to support or not support the first hypothesis. The second and third hypotheses are supported for these deep fill culverts for stiff soils. They are neither supported nor unsupported for the lowest quality soil.

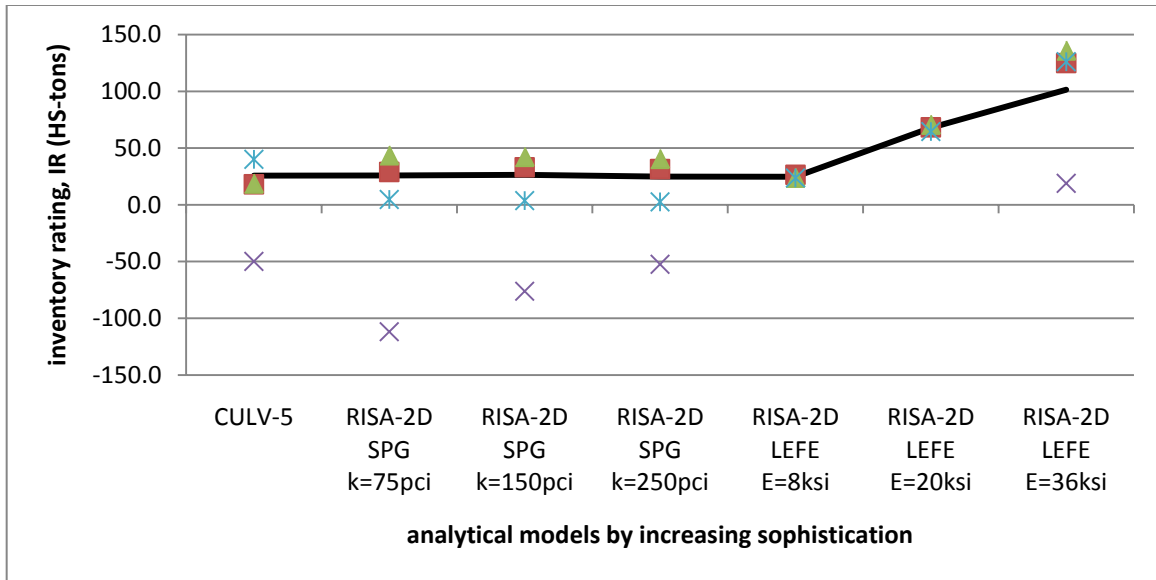

FIGURE 4.13. 1938 ERA INVENTORY RATINGS: 8' TO 18' OF FILL

#### 4. Controlling Failure Mode

Figure 4.14 shows that in the 1938 era, the load ratings are controlled by moment alone. This is to be expected due to the haunches characteristic of this design era.

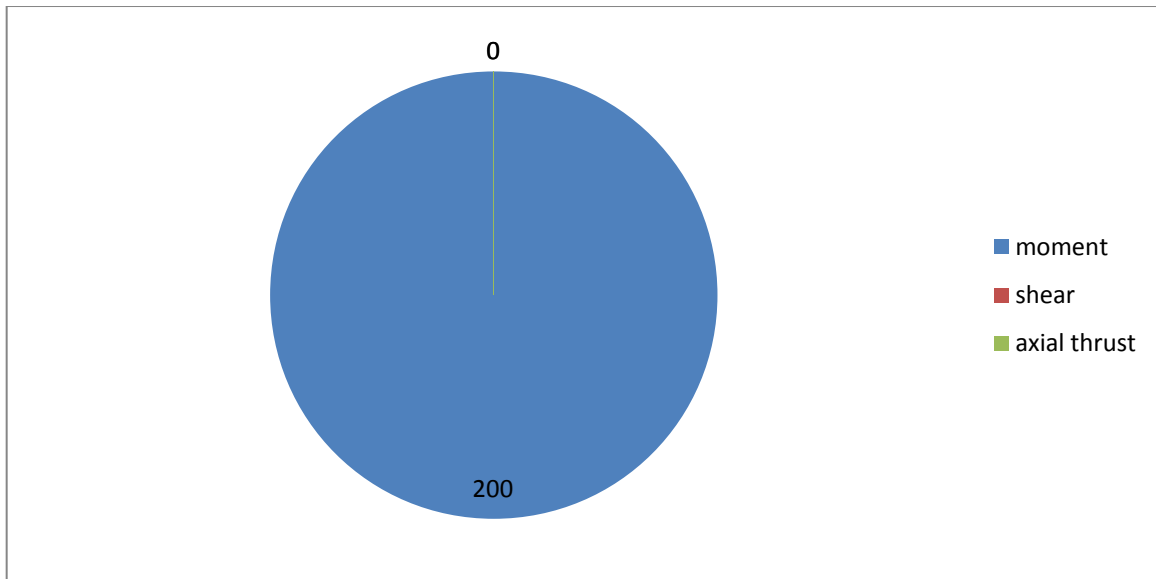

FIGURE 4.14. 1938 ERA CONTROLLING FAILURE MODES

### 5. Controlling Critical Section

Figure 4.15 shows the critical sections for the 1938 era stratified by depth of fill. The number of designs show along the horizontal axis differs for CULV-5 because CULV-5 can only load rate culverts with four or fewer barrels.

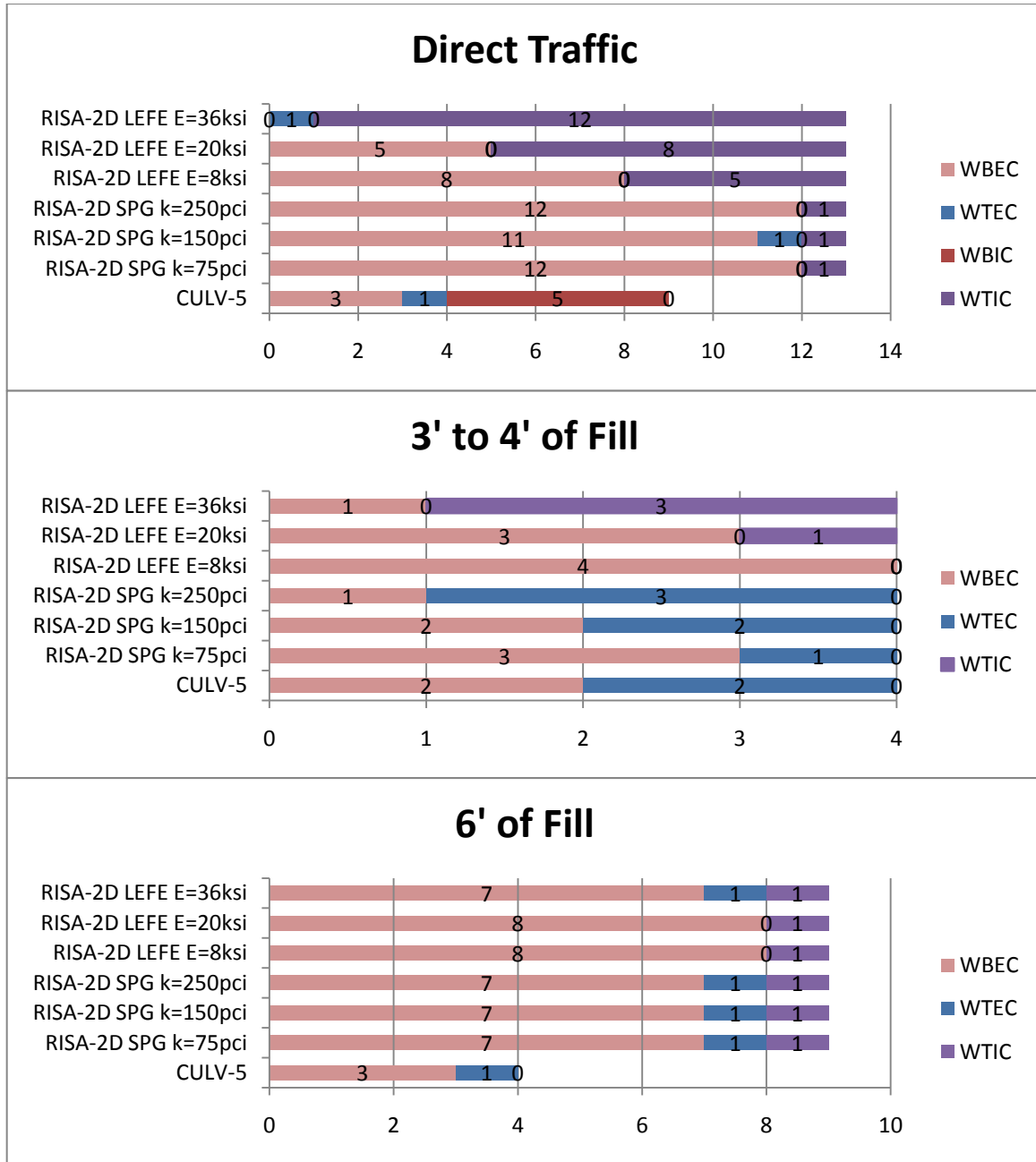

FIGURE 4.15. 1938 ERA CONTROLLING CRITICAL SECTIONS: 0 TO 6' OF FILL

For the direct traffic to medium fill culverts, the critical sections show the same tendencies. First, all the critical sections are in wall corners. Second, softer soils tend to push the critical section to the bottom corner, while stiffer soils are more likely to fail in the top interior corners.

Figure 4.16 shows the critical section for the high fill culverts in the 1938 era. All of these culverts also happen to be single barrel culverts. This may be partially responsible for the mid-span critical sections controlling so often.

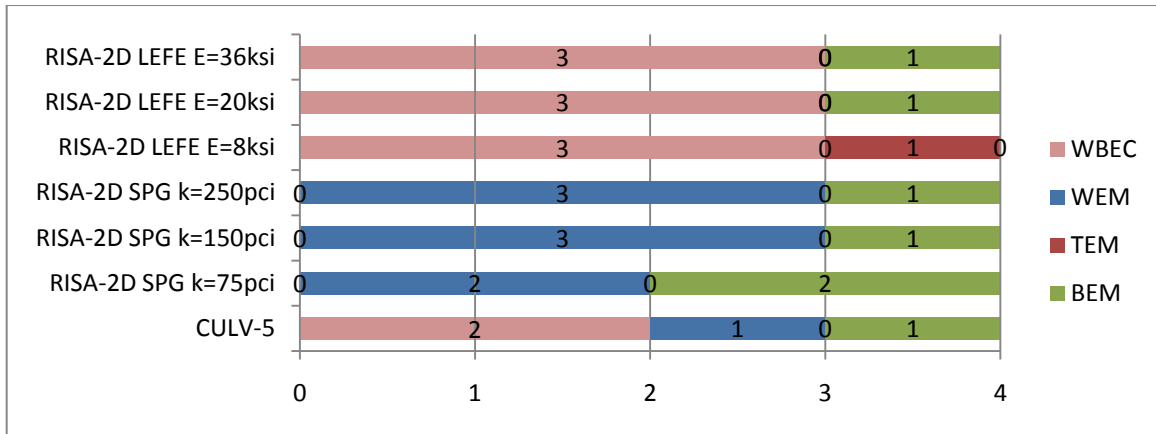

FIGURE 4.16. 1938 ERA CONTROLLING CRITICAL SECTIONS: 8' TO 18' OF FILL

## 5. 1946 ERA RESULTS

The 1946 era is the smallest of the design eras with only 53 designs on three sheets. The distinctive characteristics for this era must be broken down by sheet. Originally designed in 1946, the FM-MBC-3-26 sheet appears to be the last and pinnacle design using the 1938 era design philosophy. It is a zero to six foot of fill design with haunches. The MBC-3 sheet was also designed in 1946. This design has more in common with the 1958 era design philosophy. The sheet was designed for direct traffic using slightly thinner slabs without haunches. The MC-10-3-45 is the only sheet designed with a 45 degree skew angle. This sheet was also designed under the Texas Highway Department Supplement Number 1. The TxDOT *Bridge Inspection Manual* specifically notes that the THD supplement produced drastically unconservative designs. The MC-10-3-45 was designed for four to six feet of fill.

### 1. Undifferentiated Inventory Ratings

Figure 4.17 shows all the inventory ratings for the 1946 era. This plot indicates that the first hypothesis is generally supported by this era. The RISA-2D with spring model produces higher ratings than the CULV-5 model. Again the second and third hypotheses are partially supported. For medium and high quality soils, the RISA-2D with LEFE produces higher ratings than RISA-2D with springs and CULV-5, but for low quality soil, RISA-2D with LEFE produces the lowest ratings.

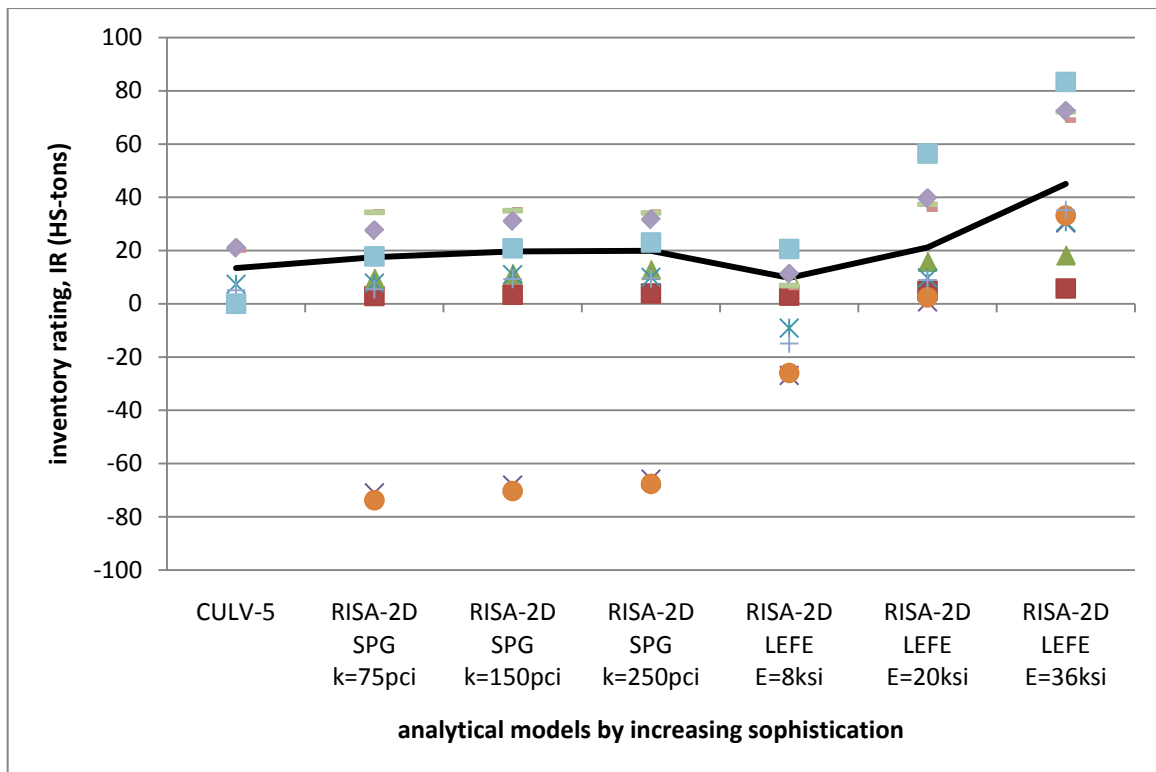

FIGURE 4.17. 1946 ERA INVENTORY RATINGS: UNDIFFERENTIATED



## 2. Identification of Statistically-Significant Culvert Variables

Figure 4.18 shows the linear-regression plots for the 1946 era. However, because of the transitional nature of the design philosophies in this era, the load rating is most significantly affected by the design sheet rather than these variables.

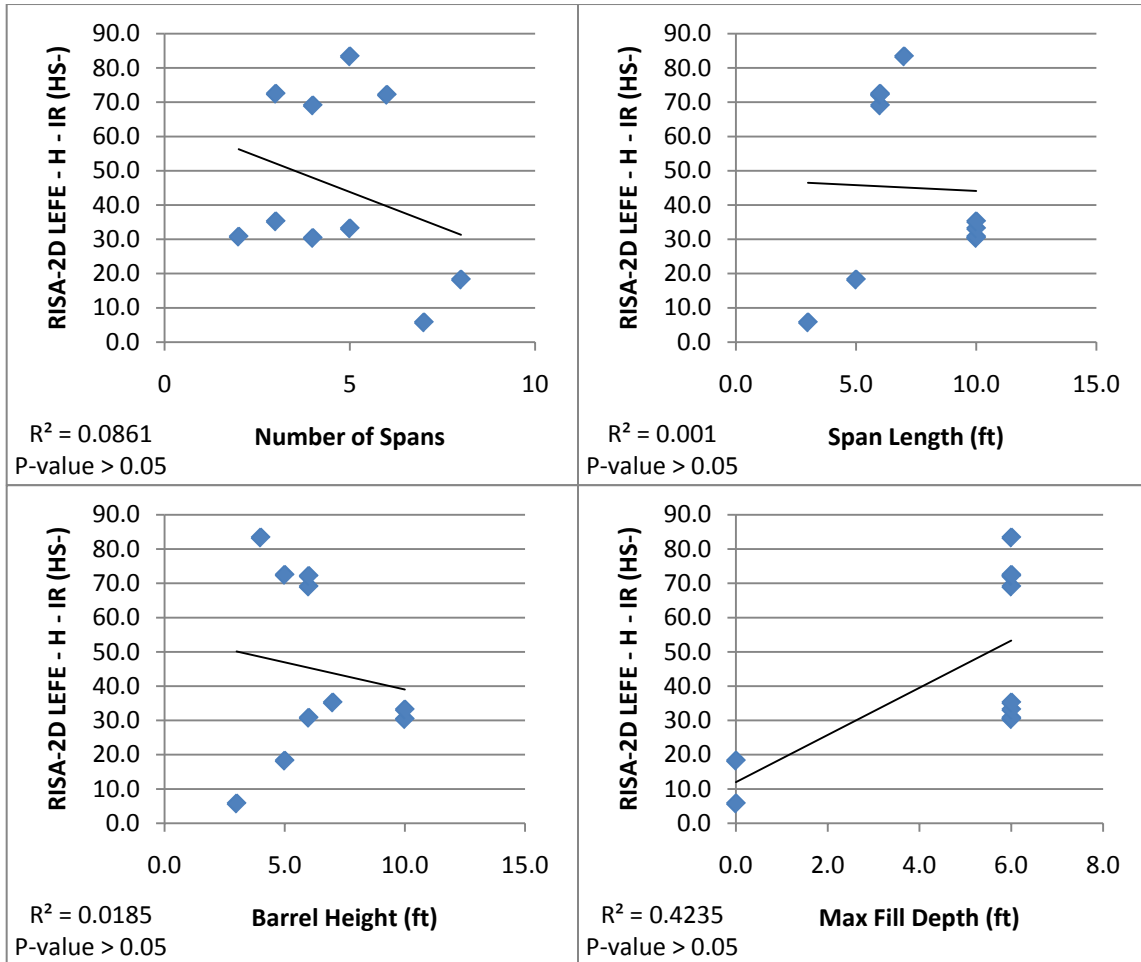

FIGURE 4.18. 1946 ERA STATISTICAL ANALYSIS FOR SIGNIFICANT INDEPENDENT VARIABLES

### 3. Differentiated Inventory Ratings by Significant Culvert Variables

Figure 4.19 shows the inventory ratings for the direct traffic designs sampled from the MBC-3 sheet. These designs produced very low ratings. The first and third hypotheses are unconfirmed for this subset, because the sampled culvert designs had more than four barrels making them unratable using CULV-5. The second hypothesis is confirmed only for the higher level soil stiffness. For low soil stiffness, RISA-2D with LEFE produces comparable ratings to RISA-2D with springs.

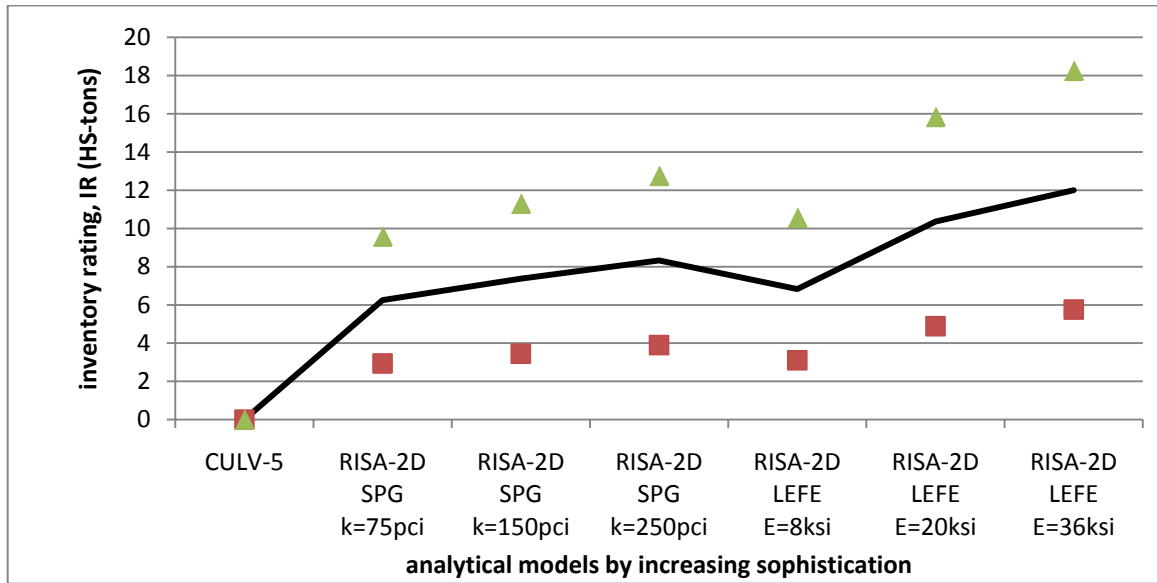

FIGURE 4.19. 1946 ERA INVENTORY RATINGS: MBC-3

Figure 4.20 shows that half the designs sampled from the sheet which were designed using THD Supplement Number 1 fail to rate positively for all but the stiffest RISA-2D with LEFE model. For the designs that do rate positively, the first hypothesis is only slightly supported by marginally higher RISA-2D with spring ratings than CULV-5 ratings. The second and third hypotheses are unsupported by the lowest soil stiffness in the RISA-2D with LEFE model, indefinite for the medium soil stiffness in the RISA-2D with LEFE model and supported for the high soil stiffness in the RISA-2D with LEFE model.

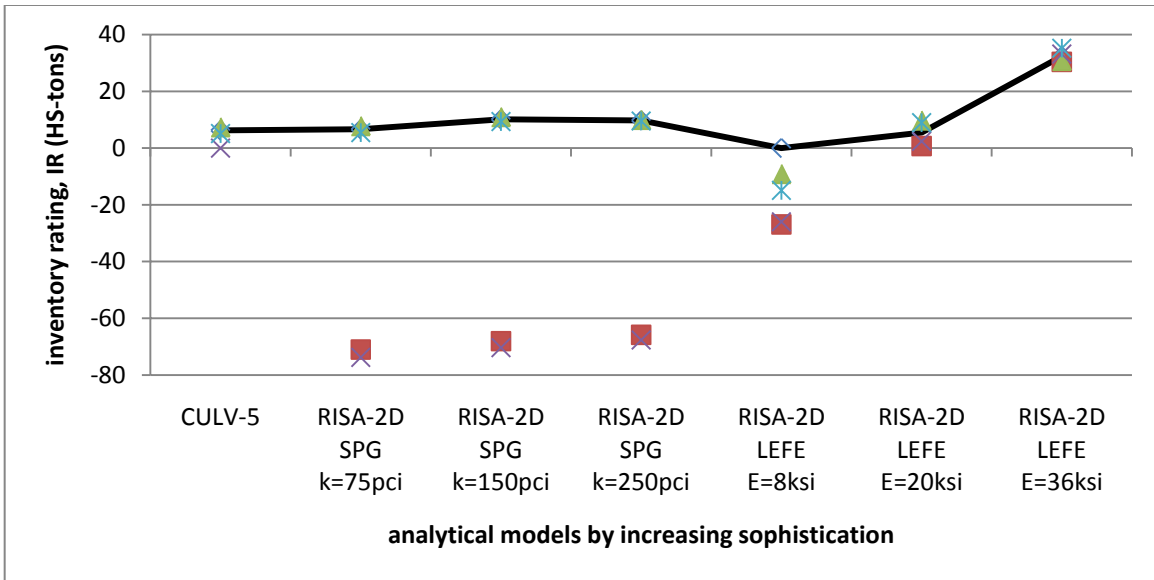

FIGURE 4.20. 1946 ERA INVENTORY RATINGS: MC10-3-45

Figure 4.21 applies to sheet FM-MBC-3-26 which is most closely related to the 1938 era. The newest haunch designs perform very well. The low CULV-5 rating supports the first hypothesis. The second and third hypotheses are supported by the medium and high grade soil in the RISA-2D with LEFE but are unsupported by the low grade soil stiffness.

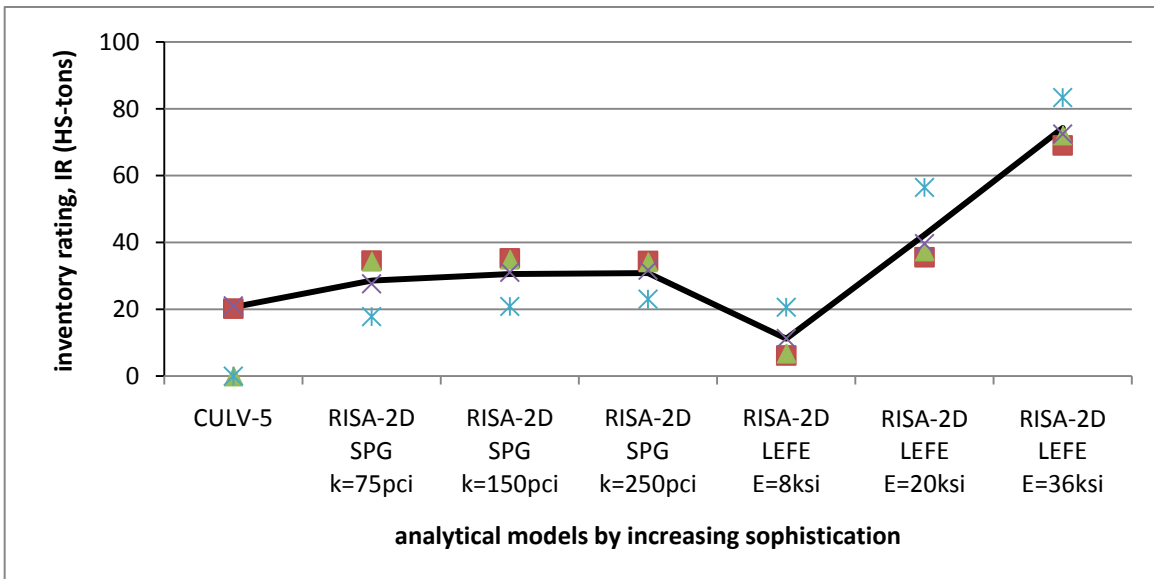

FIGURE 4.21. 1946 ERA INVENTORY RATINGS: FM-MBC-3-26

#### 4. Controlling Failure Mode

Figure 4.22 shows that the only controlling failure mode is moment.

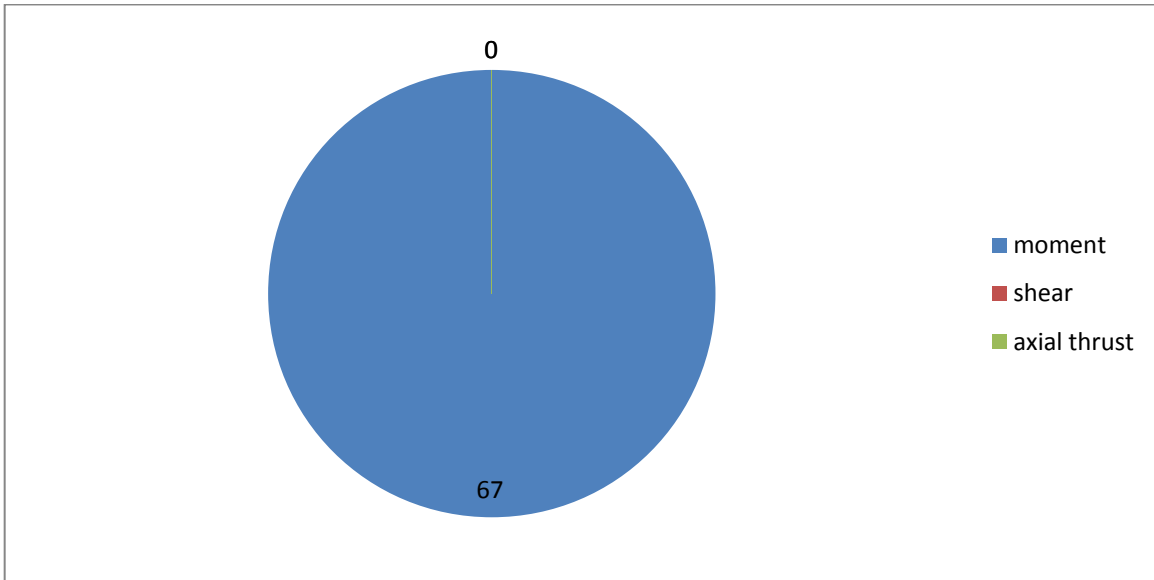

FIGURE 4.22. 1946 ERA CONTROLLING FAILURE MODES

#### 5. Controlling Critical Section

Figure 4.23 shows that the earliest of the 1946 design philosophies tended to create weak points in the top of the walls.

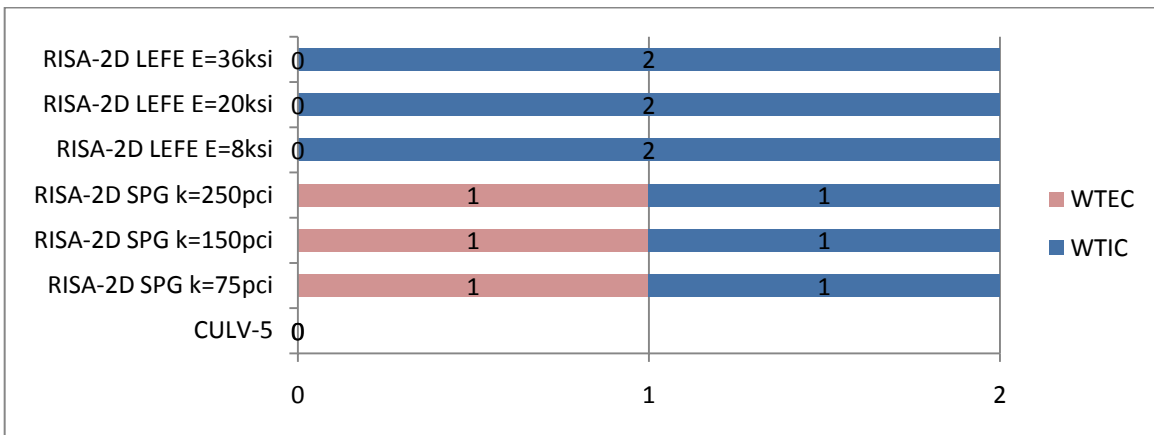

FIGURE 4.23. 1946 ERA CONTROLLING CRITICAL SECTIONS: MBC-3

Figure 4.24 shows that while the bottom wall exterior corner is the most likely place for failure, the THD Supplement Number 1 may have lead to under designing the mid-spans.

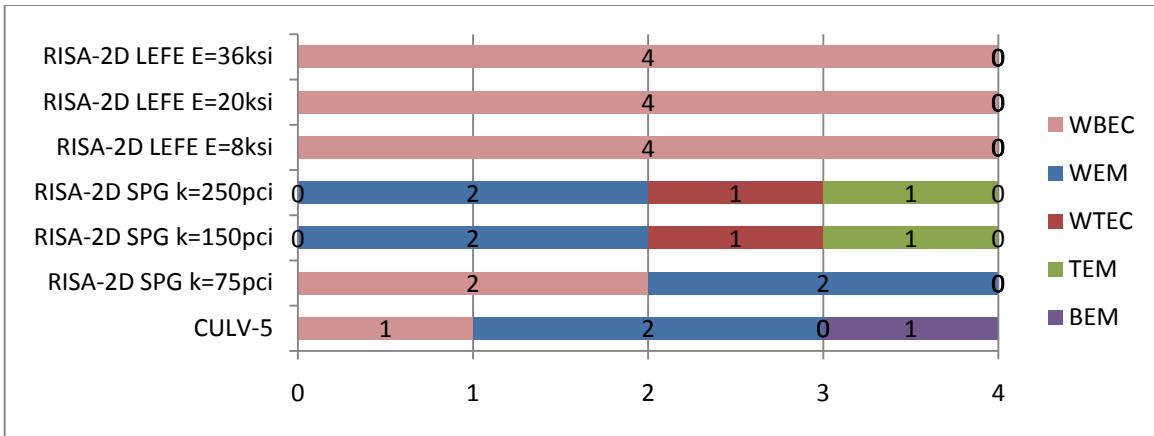

FIGURE 4.24. 1946 ERA CONTROLLING CRITICAL SECTIONS: MC-10-3-45

Figure 4.25 shows that for the sheet most related to the 1938 era, the trends are the same as for the 1938 era. Stiffer soil models tend to move the critical section from the base of the exterior wall to the top of the exterior wall.

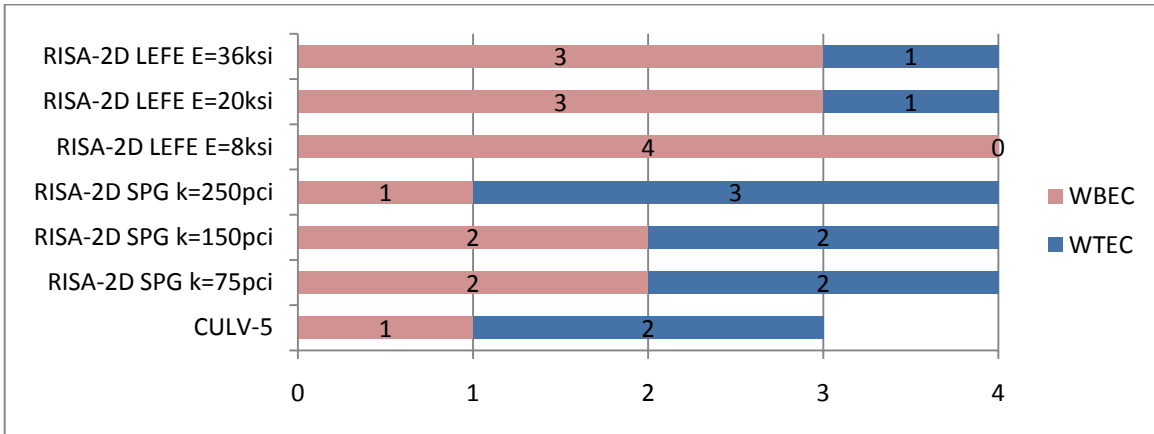

FIGURE 4.25. 1946 ERA CONTROLLING CRITICAL SECTIONS: FM-MBC-3-26

## 6. 1958 ERA STRUCTURAL GRADE STEEL (36 KSI)

The 1958 era represents the design era under which most of TxDOT's culverts have been built. Designs from this era have no haunches. The designs were originally developed for HS-20 loading but with a reduced dead load, and this resulted in increasing the allowable stress in the structure. Under the current load rating requirements, these designs show some of the greatest variety in load rating and critical section. Available data suggest that this design era was updated in 1977 to require grade 60 steel instead of the assumed structural grade steel required by the original design. This has the affect of basically splitting this era into two sub-eras: the 1958-1977 era (which uses structural grade steel) and the 1977-2003 era (which uses grade 60 steel). Therefore the sample culverts in this era were analyzed twice. The first round of analysis assumed structural grade steel with a yield stress of 36ksi.

### 1. Undifferentiated Inventory Ratings

Figure 4.26 shows all the load rating for the 1958 era using 36ksi steel. From this chart is difficult to say if the hypotheses are supported. CULV-5, RISA-2D with springs and the lowest quality RISA-2D with LEFE all produce equivalent results on average. The second and third hypotheses are partially supported by the medium and high quality soils in the RISA-2D with LEFE. These two methods provide higher ratings than all the others. Also of interest is the fact that almost all of the less sophisticated models produce load ratings below the required HS-20. It is only with decent soils and the LEFE model that the culverts begin to load rate adequately.

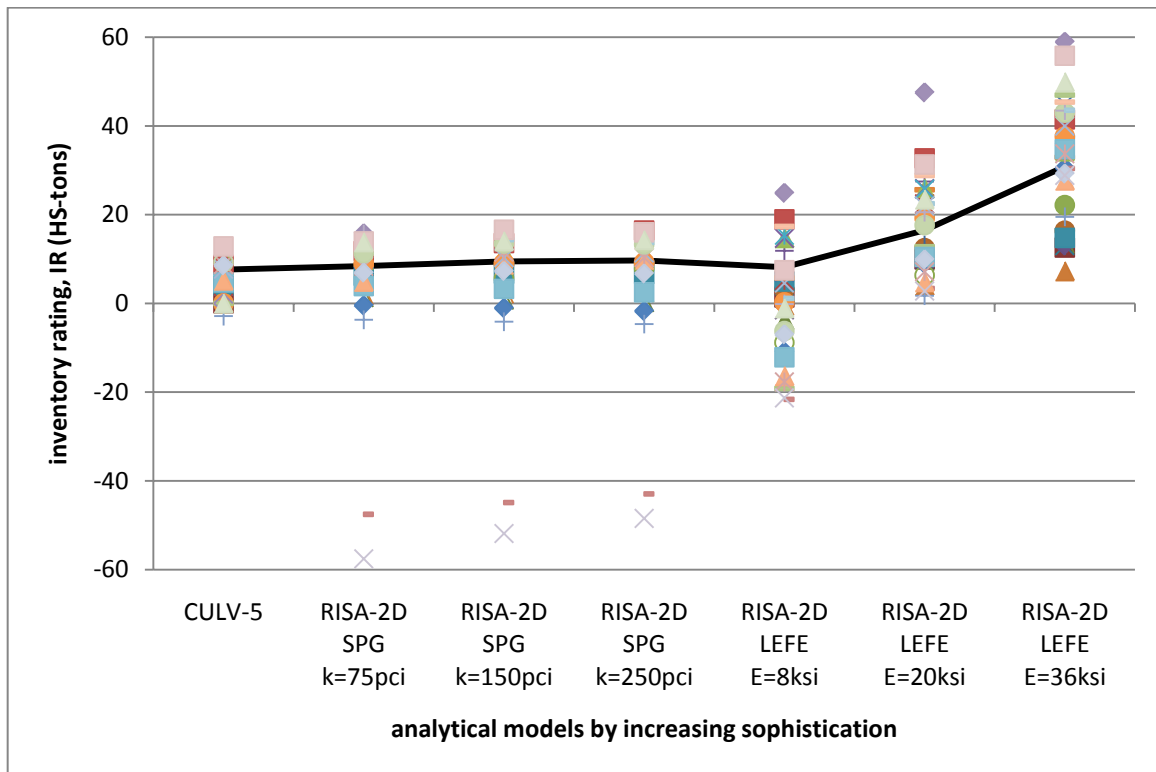

FIGURE 4.26. 1958 ERA 36KSI STEEL INVENTORY RATINGS: UNDIFFERENTIATED

## 2. Identification of Statistically-Significant Culvert Variables

Figure 4.27 makes it clear that depth of fill is the only variable which is directly related to the inventory rating.

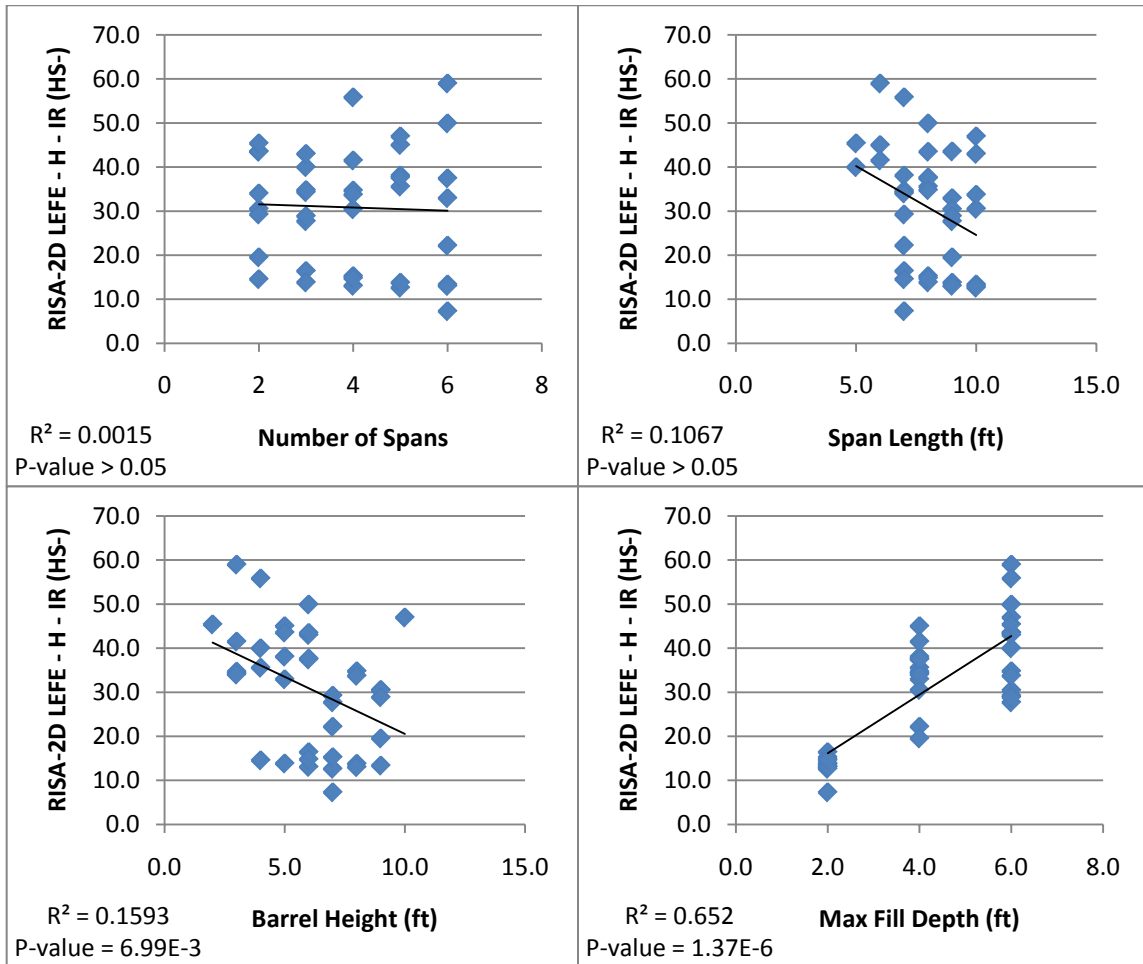

FIGURE 4.27. 1958 ERA 36KSI STEEL STATISTICAL ANALYSIS FOR SIGNIFICANT INDEPENDENT VARIABLES

### 3. Differentiated Inventory Ratings by Significant Culvert Variables

Figure 4.28 shows what is quickly becoming the normative trend. The CULV-5 rating is lower than the RISA-2D with spring ratings, thus supporting the first hypothesis. The second and third hypotheses are supported because the medium and high quality soils in the RISA-2D with LEFE model produce higher ratings than RISA-2D with springs and CULV-5. However, the second and third hypotheses are not supported totally because the RISA-2D with LEFE model using low stiffness soils produces lower ratings than CULV-5 and RISA-2D with springs.

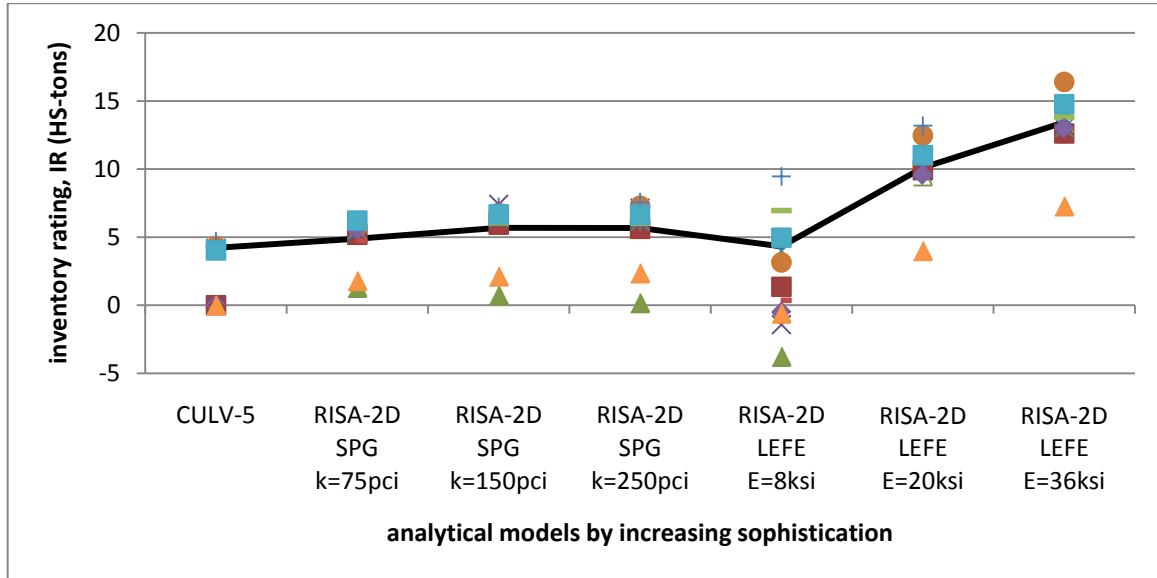

FIGURE 4.28. 1958 ERA 36KSI STEEL INVENTORY RATINGS: 2' OF FILL

It is also worth noting that no culvert designed for two feet of fill rates high enough to not require load posting. This suggests a weakness in the TxDOT culvert designs in this sub-era.

Figure 4.29 and Figure 4.30 show the inventory ratings for four foot and six foot of fill. For these medium depth culverts, the ratings using CULV-5, RISA-2D with spring and the low quality soil in the RISA-2D with LEFE model are too close together to make a judgment call. It is clear that for higher stiffness soil, RISA-2D with LEFE rates higher than other methods.



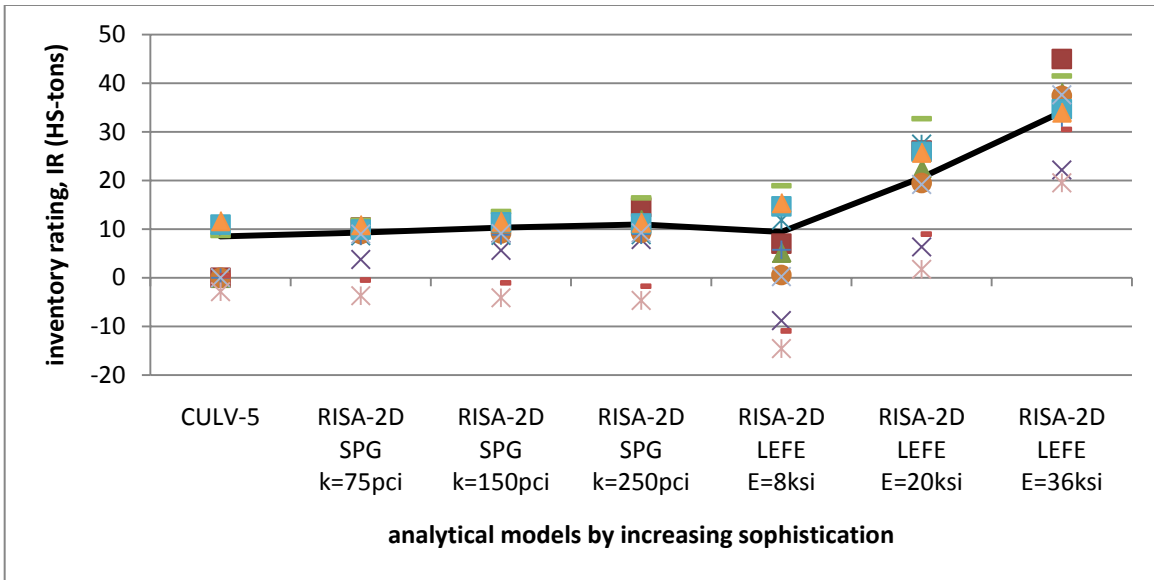

FIGURE 4.29. 1958 ERA 36KSI STEEL INVENTORY RATINGS: 4' OF FILL

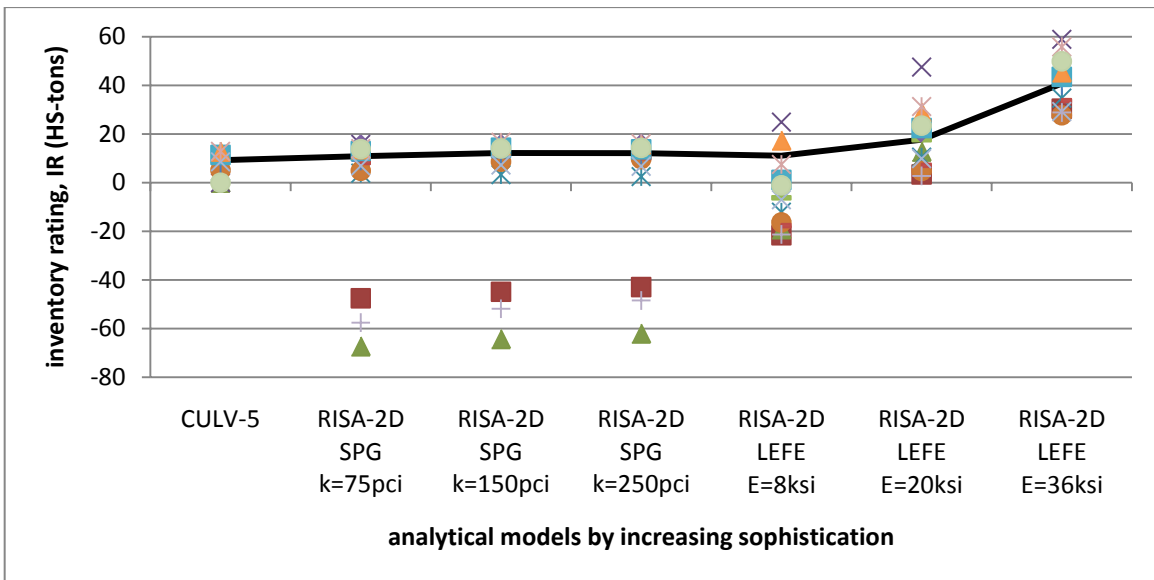

FIGURE 4.30. 1958 ERA 36KSI STEEL INVENTORY RATING: 6' OF FILL

#### 4. Controlling Failure Mode

Figure 4.31 shows that for this sub-era, moment is the predominant controlling failure mode. A single rating failed in shear for the highest quality soil in the RISA-2D with LEFE. This would be disturbing if that single rating were not nearly three times greater than the design load (HS-59 compared to HS-20).

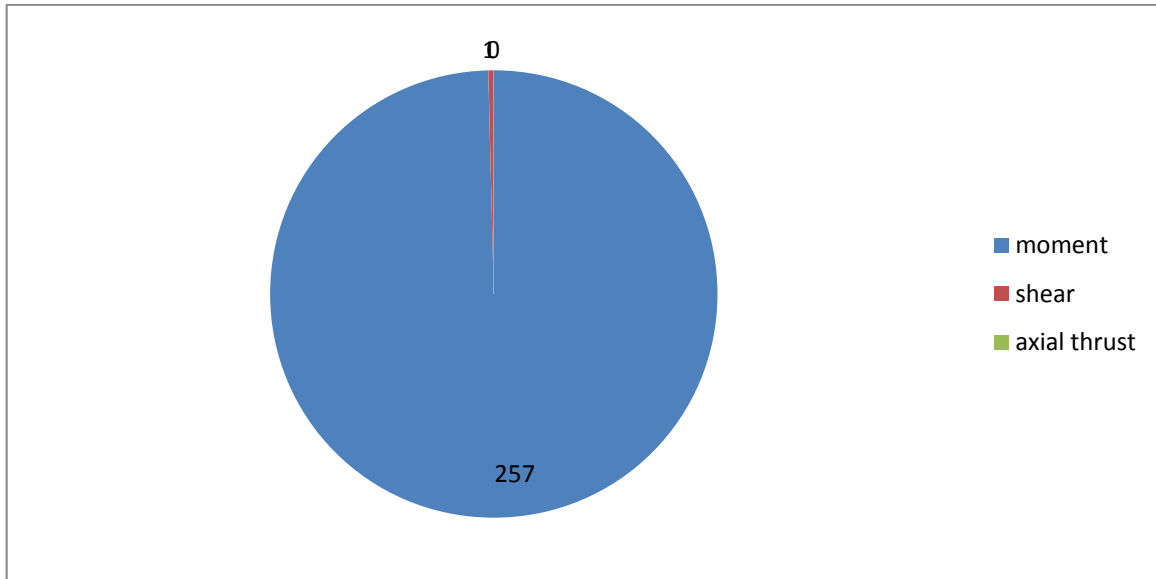

FIGURE 4.31. 1958 ERA 36KSI STEEL CONTROLLING FAILURE MODES

#### 5. Controlling Critical Section

The controlling critical sections showed a great deal of variety. For the low fill culverts, Figure 4.32 shows that CULV-5 produced failing critical sections in the bottom slab only. TxDOT has always felt CULV-5 was overly conservative in the bottom slab. The other models showed failure modes throughout the corners of the structures. Interestingly for the higher level RISA-2D with LEFE models, the controlling critical sections occurred at interior corners. These are not typically thought to be critical in culvert design.

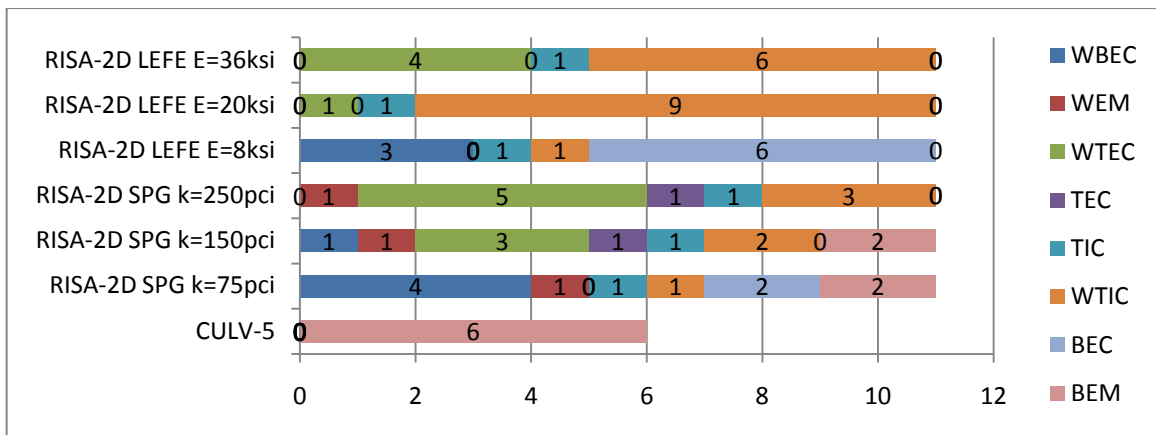

FIGURE 4.32. 1958 ERA 36KSI STEEL CONTROLLING CRITICAL SECTIONS: 2' OF FILL

Figure 4.33 shows that for the culverts designed for four feet of fill, the results are only slightly different. CULV-5 tended to identify the bottom slab. In the RISA-2D with springs models, the top slab was often the controlling section. For the RISA-2D with LEFE the exterior wall corners were the weakest points.

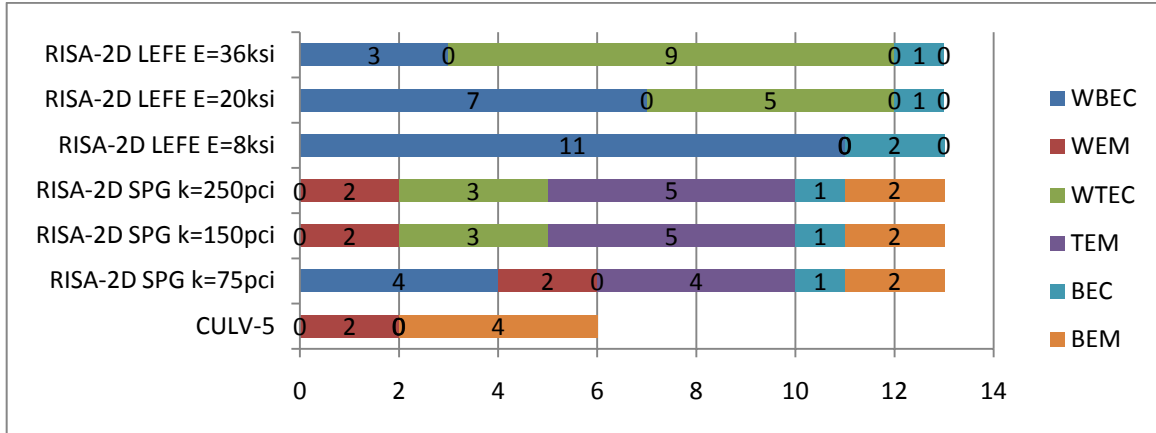

FIGURE 4.33. 1958 ERA 36KSI STEEL CONTROLLING CRITICAL SECTIONS: 4' OF FILL

Figure 4.34 shows that for the six foot of fill culverts, the CULV-5 and RISA-2D with springs identified similar critical sections in the wall and top slab mid-spans. For RISA-2D with LEFE the bottom exterior wall corner tended to controlled again.

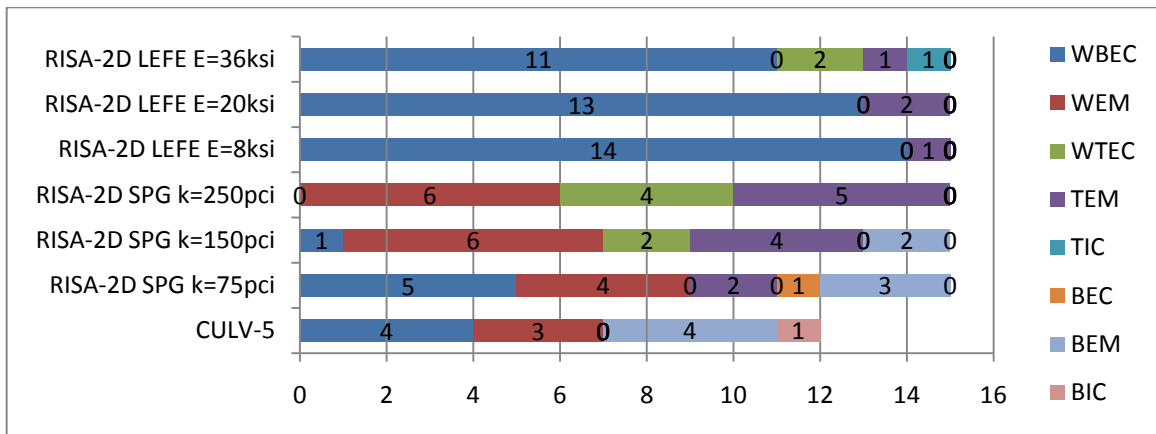

FIGURE 4.34. 1958 ERA 36KSI STEEL CONTROLLING CRITICAL SECTIONS: 6' OF FILL

## 7. 1958 ERA GRADE 60 STEEL (60 KSI)

The second round of analysis for this era assumed a steel yield strength of 60ksi. The demands were unchanged, but the capacity was increased. This resulted in different results altogether.

### 1. Undifferentiated Inventory Ratings

In Figure 4.35, the most obvious improvement in the 1958 era using 60ksi steel is the overall increase in the ratings. Even CULV-5 averages above HS-20. This is a significant increase in load rating over the 36ksi equivalent. Much like the 36ksi sub-era, the values neither support or deny the first hypothesis. CULV-5 and RISA-2D with springs simply provide solutions which are too similar. What is interesting is that the second and third hypotheses are for the first time, fully supported. All levels of RISA-2D with LEFE produce higher ratings than CULV-5 or RISA-2D with springs.

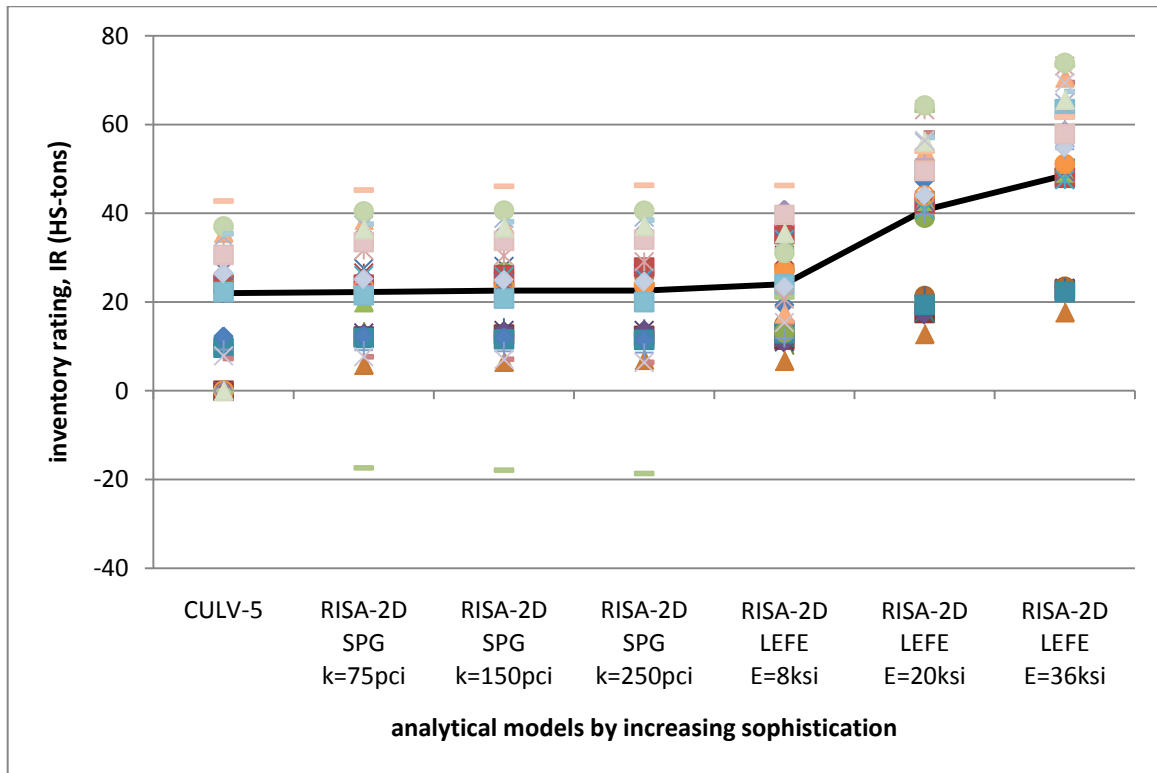

FIGURE 4.35. 1958 ERA 60KSI STEEL INVENTORY RATINGS: UNDIFFERENTIATED

## 2. Identification of Statistically-Significant Culvert Variables

For the 1958 era with 60ksi steel, Figure 4.36 shows that the only independent variable that statistically impacts the inventory rating is the depth of fill.

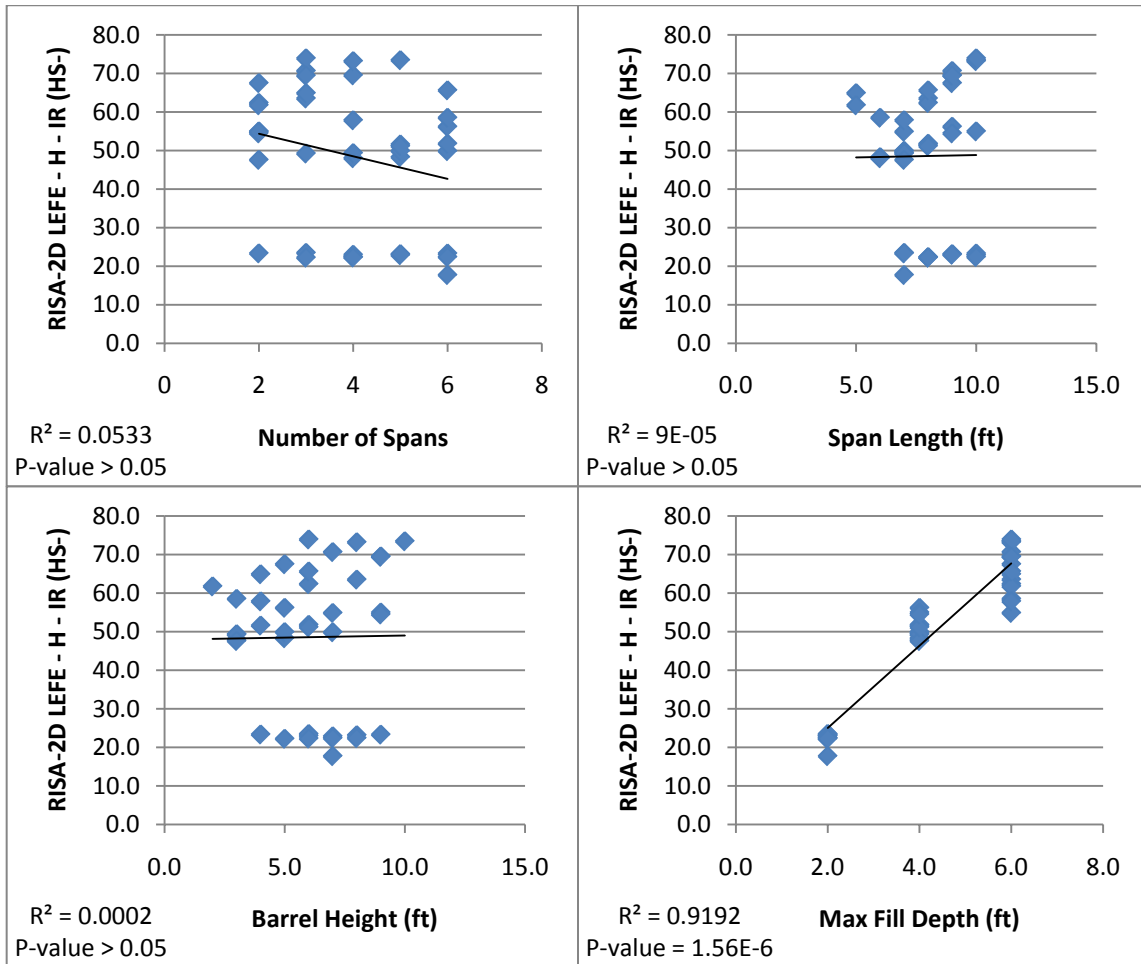

FIGURE 4.36. 1958 ERA 60KSI STEEL STATISTICAL ANALYSIS FOR SIGNIFICANT INDEPENDENT VARIABLES

### 3. Differentiated Inventory Ratings by Significant Culvert Variables

For this sub-era with two feet of fill, Figure 4.37 shows that all hypotheses are supported. RISA-2D with LEFE produces higher ratings that RISA-2D with springs which is higher than CULV-5.

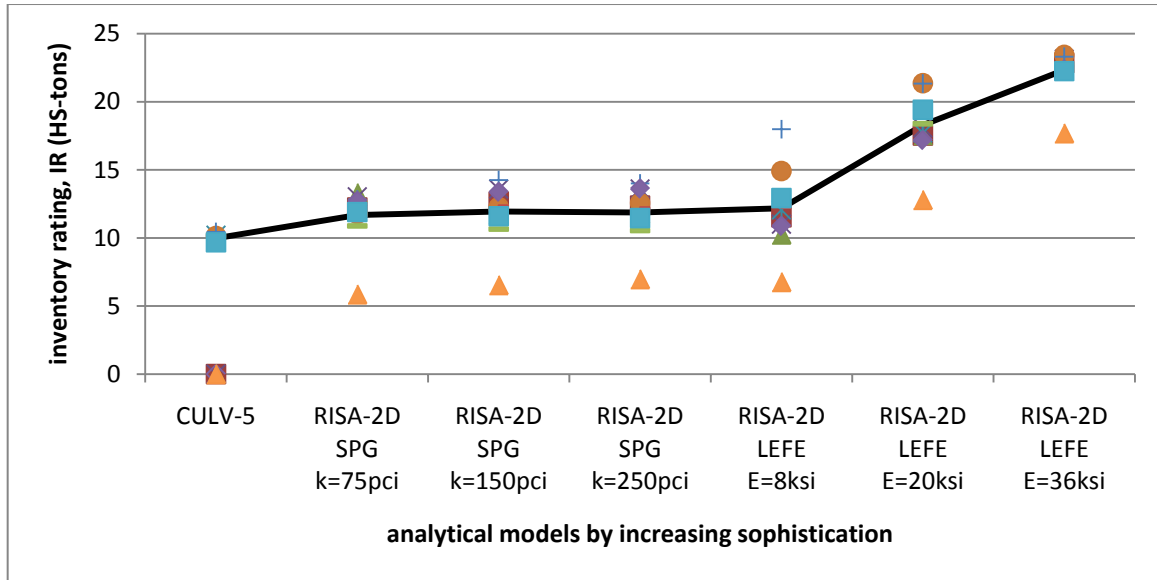

FIGURE 4.37. 1958 ERA 60KSI STEEL INVENTORY RATINGS: 2' OF FILL

For the four foot of fill culverts, Figure 4.38 shows that the case is not as conclusive for the first hypothesis. The CULV-5 and RISA-2D with springs models all produce approximately the same load ratings. The second and third hypotheses are fully supported. The RISA-2D with LEFE models produce far greater ratings than the CULV-5 or RISA-2D with spring models.

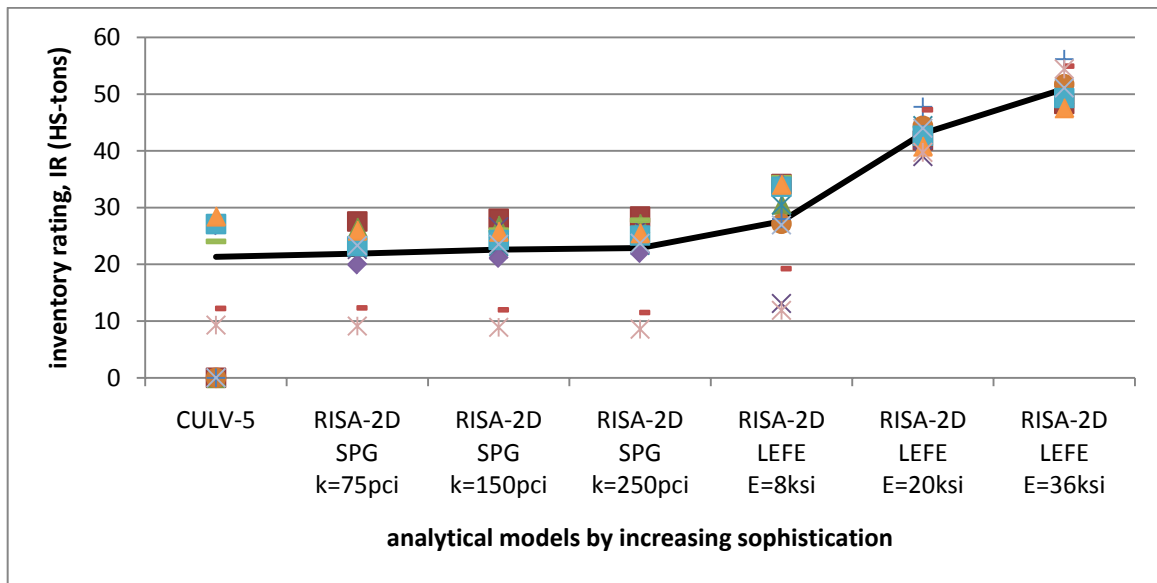

FIGURE 4.38. 1958 ERA 60KSI STEEL INVENTORY RATING: 4' OF FILL

The six foot of fill culvert ratings in Figure 4.39 show inconclusive changes in the load rating between the CULV-5, RISA-2D with springs and the lowest quality RISA-2D with

LEFE models. That means that the second and third hypotheses are only partly supported by the higher ratings of the RISA-2D with LEFE models using the medium and high stiffness soil modulus.

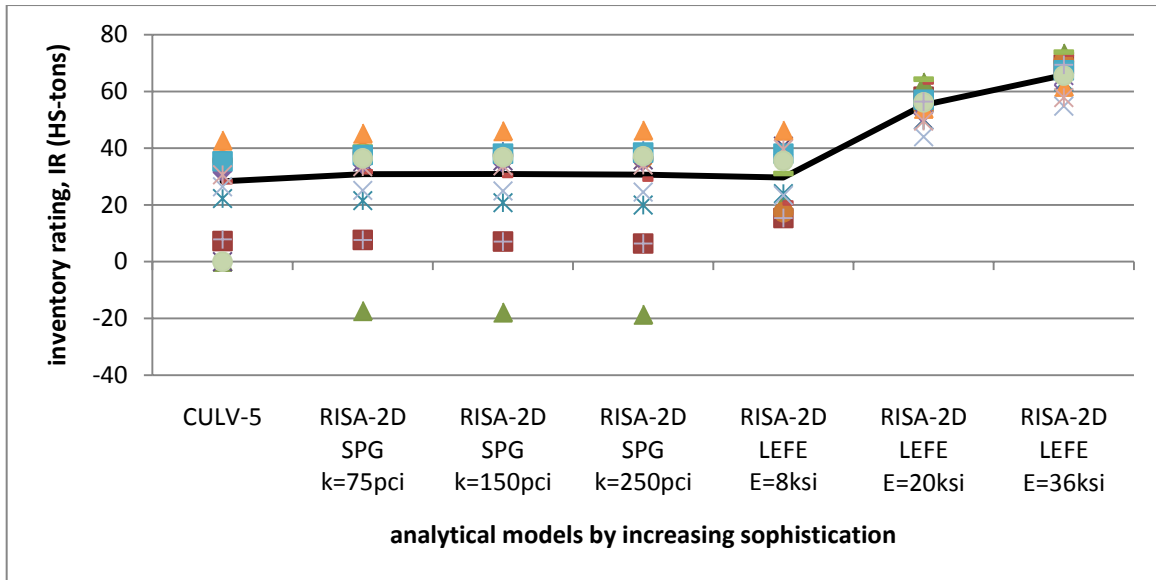

FIGURE 4.39. 1958 ERA 60KSI STEEL INVENTORY RATINGS: 6' OF FILL

#### 4. Controlling Failure Mode

Figure 4.40 shows the controlling failure modes differentiated by model for the 1958 era culverts using 60ksi steel. In this case shear controls nearly a third of the time. The increase in steel strength is directly related to an increase in moment capacity, but shear capacity is unaffected by reinforcing steel. Shear controls more often in the stiffer RISA-2D with LEFE models.

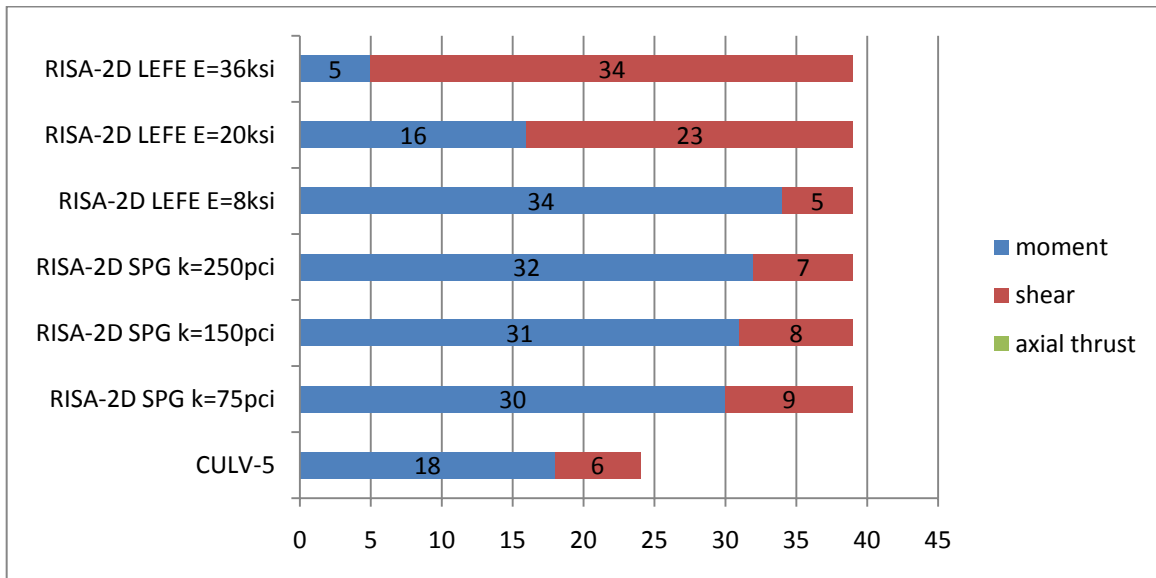

FIGURE 4.40. 1958 ERA 60KSI STEEL CONTROLLING FAILURE MODES

### 5. Controlling Critical Section

Figure 4.41 shows that for this 1958 sub-era, the most popular controlling critical section in the top of the interior wall corner. For CULV-5, the bottom mid-span controls. As the soil becomes stiffer, the RISA-2D with LEFE model identifies critical sections in the top slab at the interior corners.

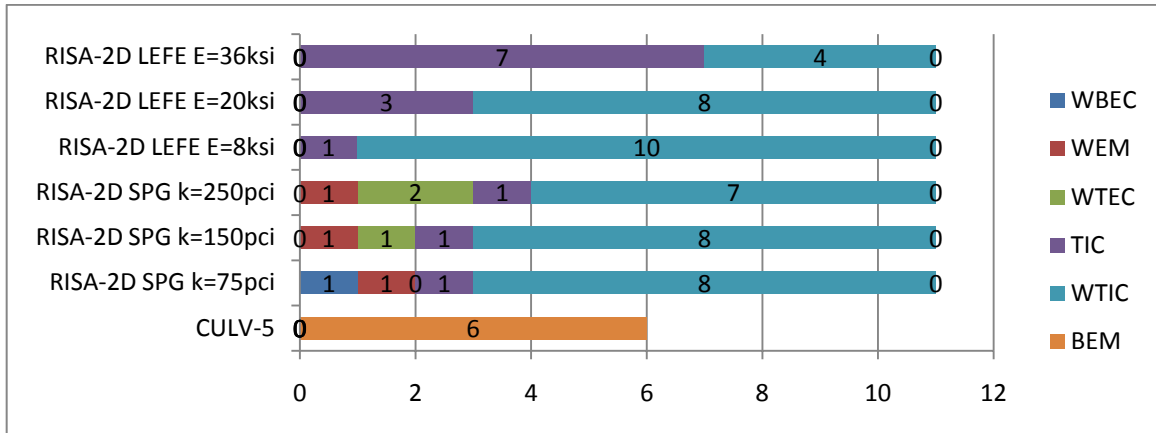

FIGURE 4.41. 1958 ERA 60KSI STEEL CONTROLLING CRITICAL SECTIONS: 2' OF FILL

Figure 4.42 shows the critical sections for those culverts with four feet of fill. The less sophisticated models show no defined trends. In the higher stiffness RISA-2D with LEFE, the top span interior corners control almost exclusively.

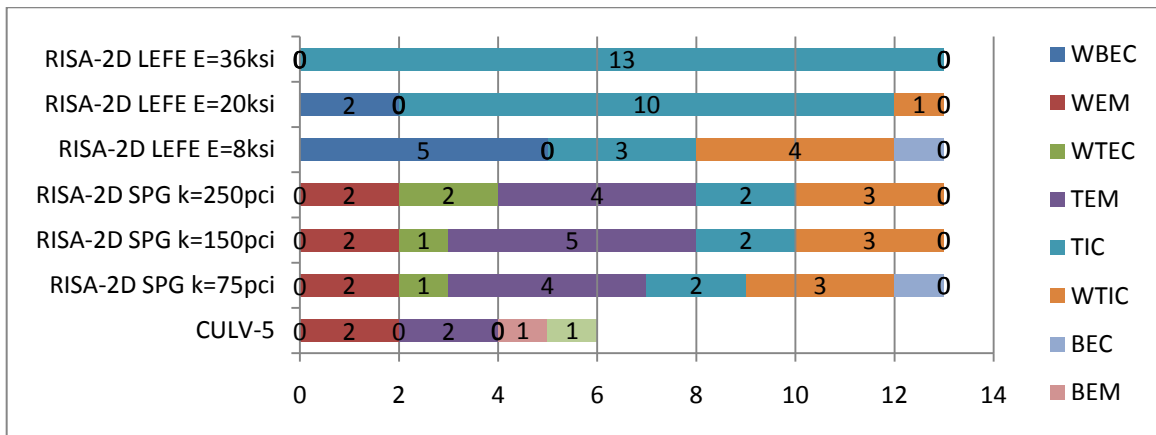

FIGURE 4.42. 1958 ERA 60KSI STEEL CONTROLLING CRITICAL SECTIONS: 4' OF FILL

In the culverts designed for six foot of fill, Figure 4.43 shows that the top interior corner is the most likely critical section. For the less sophisticated models the exterior wall mid-span also has a high probability of controlling the load rating.



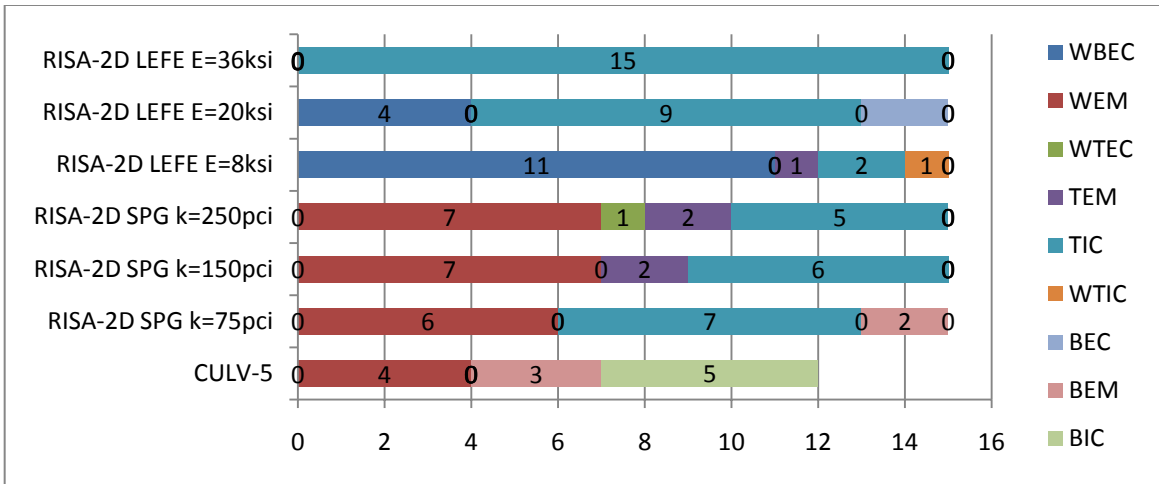

FIGURE 4.43. 1958 ERA 60KSI STEEL CONTROLLING CRITICAL SECTIONS: 6' OF FILL

## 8. 2003 ERA

The most recent full set of culverts sheets were designed in 2003. These culverts feature high strength steel and concrete, have no haunches and are relatively thin slabbed. This set contains the largest number of designs and the fewest number of constructed culverts. The most notable design characteristic is the depth of fill. Previous designs were developed for no more than six feet of fill and usually for only a two foot range. The 2003 culverts are designed for maximum fill between seven and twenty-three feet. For all designs the minimum fill is two feet. This makes the whole set of culverts significantly different from all other design eras.

### 1. Undifferentiated Inventory Ratings

Figure 4.44 shows the trends for all the designs sampled from this era. Clearly, the first hypothesis is not supported. CULV-5 produces slightly higher ratings than the RISA-2D with springs models. The second and third hypotheses are partially supported for the medium and high stiffness soils in the RISA-2D with LEFE models. The low stiffness modulus in the RISA-2D with LEFE produce lower load ratings than the CULV-5 and RISA-2D with springs models. Also, on average the ratings are higher than HS-20.

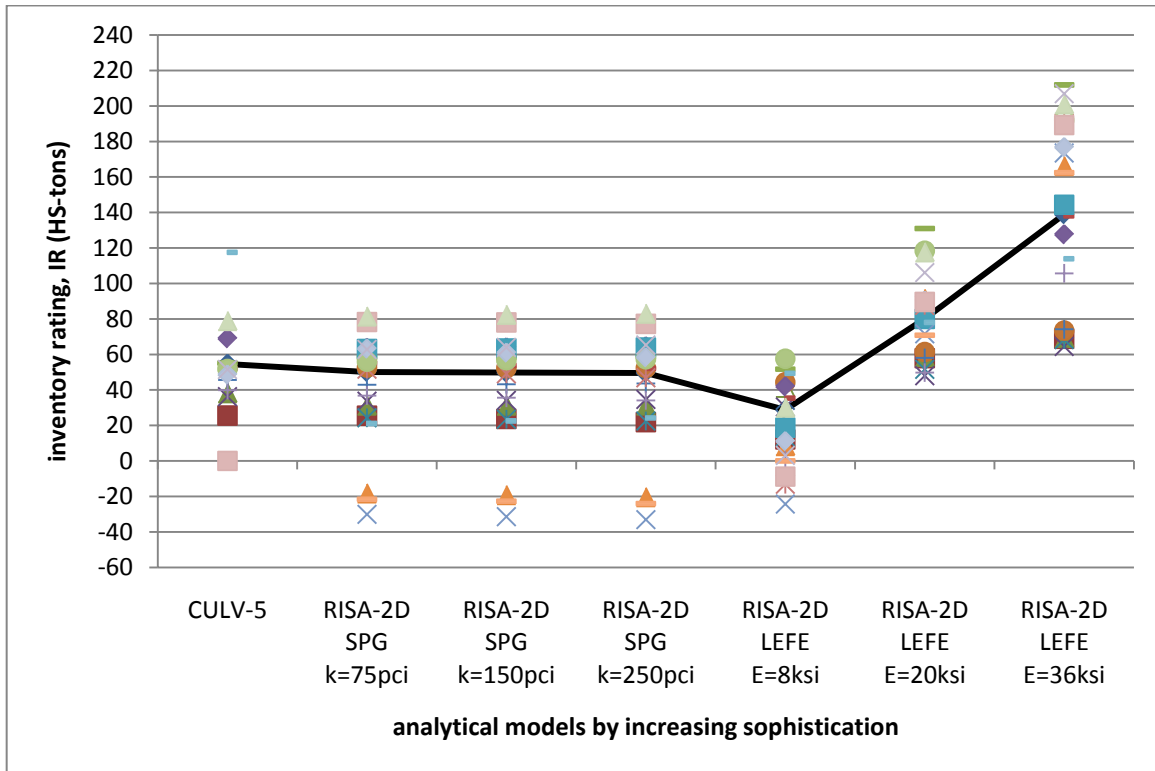

FIGURE 4.44. 2003 ERA INVENTORY RATINGS: UNDIFFERENTIATED

## 2. Identification of Statistically-Significant Culvert Variables

Once again, Figure 4.45 shows that the only variable that significantly impacts the inventory rating is the depth of fill.

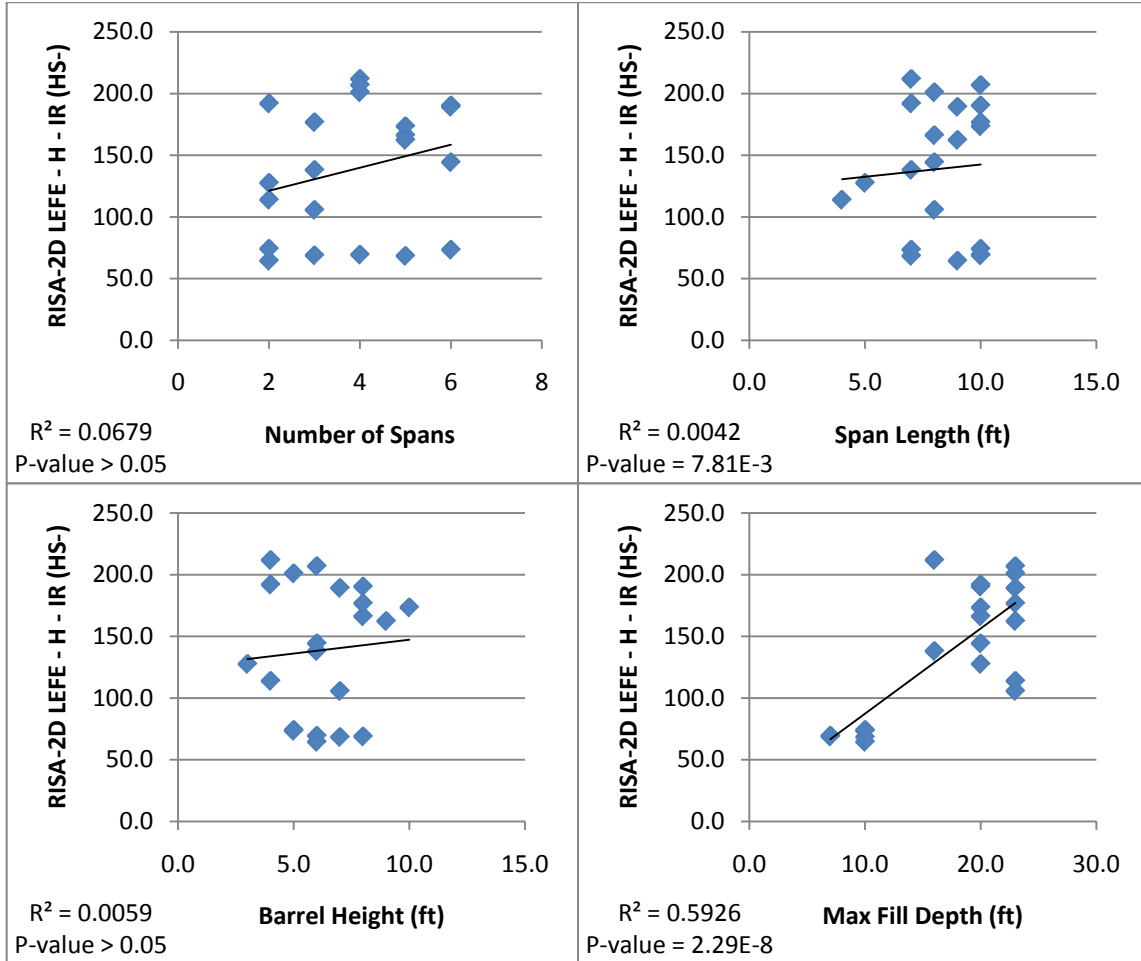

FIGURE 4.45. 2003 ERA STATISTICAL ANALYSIS FOR SIGNIFICANT INDEPEDNET VARIABLES

### 3. Differentiated Inventory Ratings by Significant Culvert Variables

The lowest fill culverts in this era have more fill than the high fill culverts in the previous design eras. For culverts with between seven feet and sixteen feet of fill, Figure 4.46 shows that it is too close to decide if the first hypothesis is supported. The CULV-5 model may produce slightly higher load ratings than the RISA-2D with springs. The lowest stiffness RISA-2D with LEFE model produces even lower ratings. Never the less, the second and third hypotheses are partially supported by higher ratings in the medium and high quality RISA-2D with LEFE analyses.

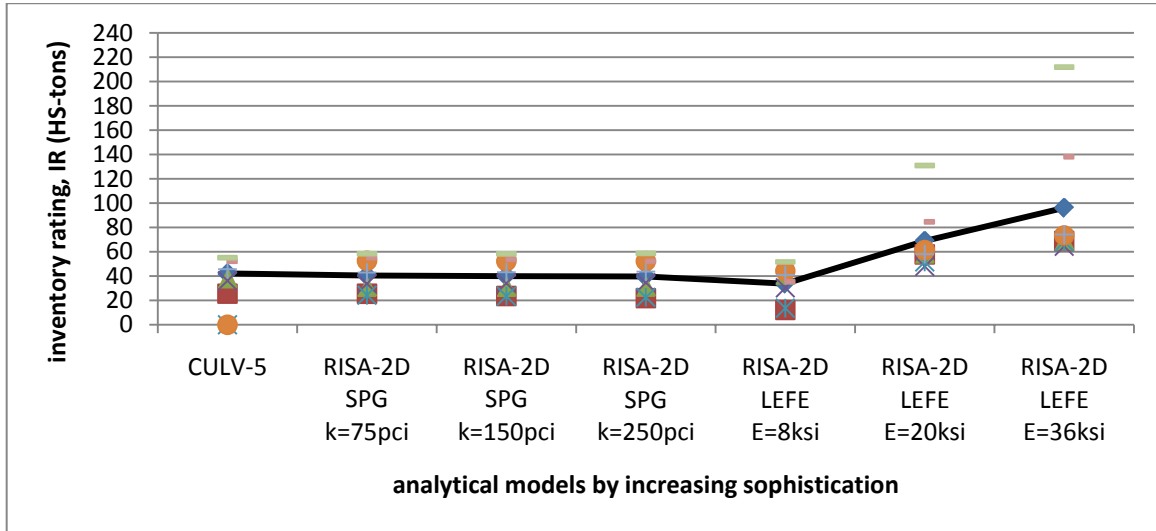

FIGURE 4.46. 2003 ERA INVENTORY RATINGS: 7' TO 16' OF FILL

For twenty feet of fill, the trend is much the same. Figure 4.47 shows that CULV-5 produces marginally higher ratings than RISA-2D with springs. RISA-2D with LEFE and low soil stiffness produces the lowest ratings, but RISA-2D with LEFE and the medium and high soil stiffnesses produce ratings higher than the other models. The first hypothesis is barely unsupported, while the second and third hypotheses are partially supported.

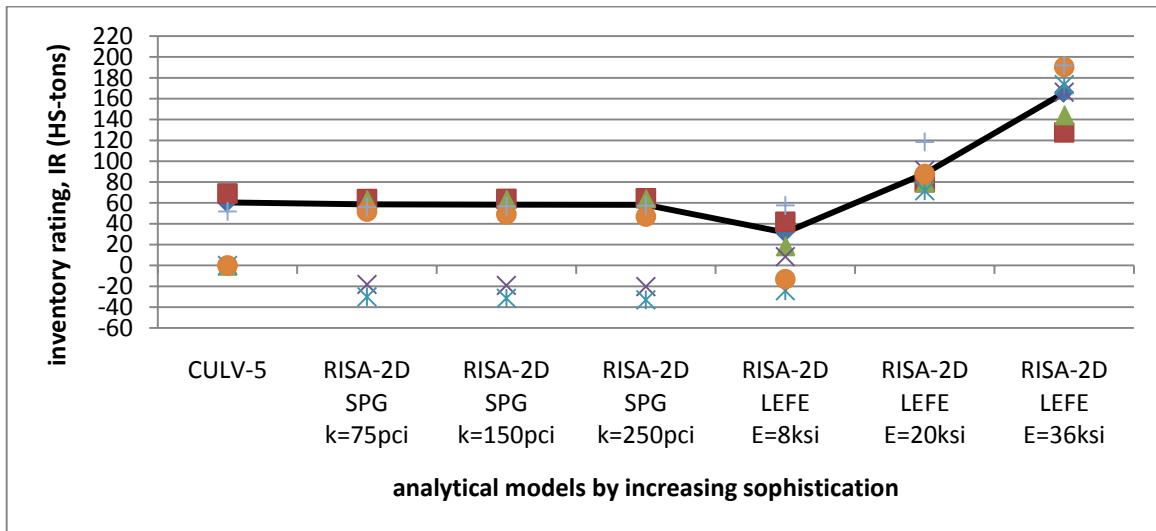

FIGURE 4.47. 2003 ERA INVENTORY RATINGS: 20' OF FILL

For the deepest fill culverts, Figure 4.48 shows that the first hypothesis is decidedly unsupported. The second and third hypotheses are again partially supported with higher load ratings for the medium and high stiffness soils.

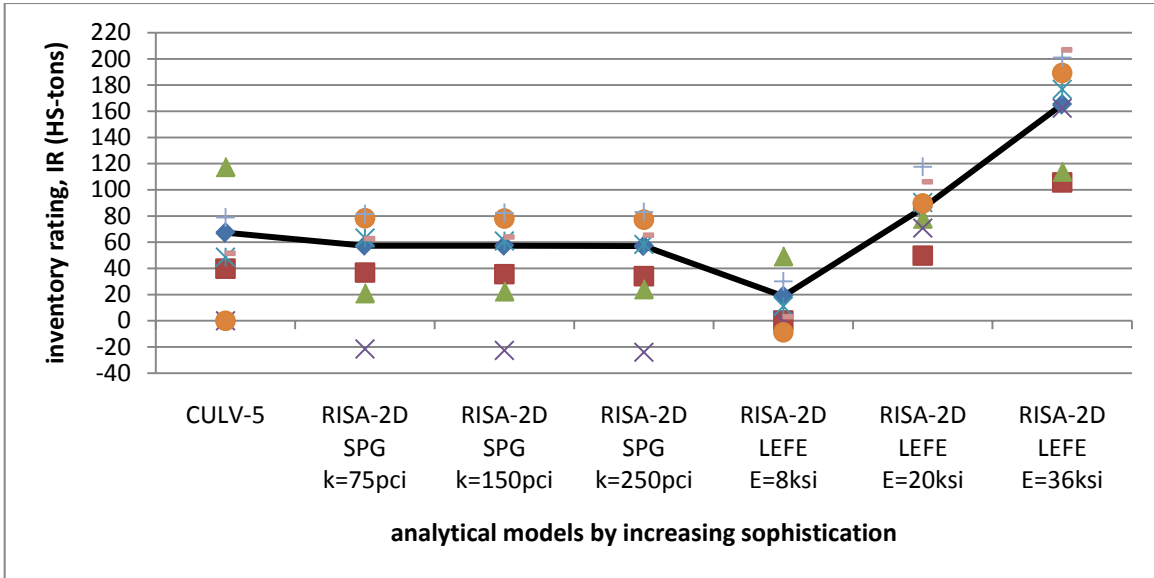

FIGURE 4.48. 2003 ERA INVENTORY RATINGS: 23' OF FILL

#### 4. Controlling Failure Mode

Figure 4.49 shows that the split between shear controlled failure and moment controlled failure is nearly even. Having shear control so often is unnerving.

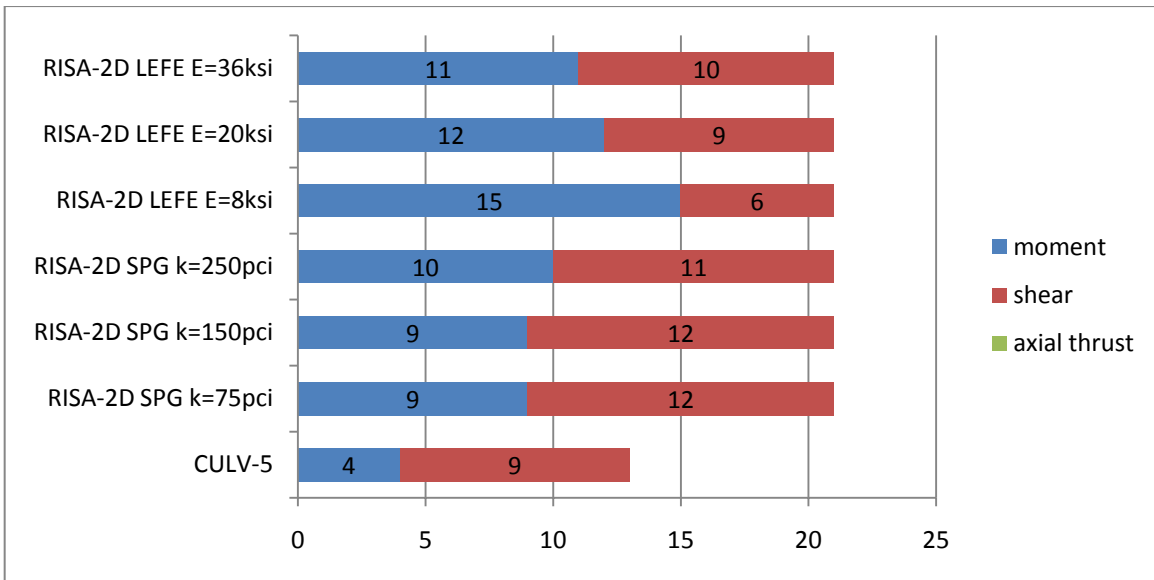

FIGURE 4.49. 2003 ERA CONTROLLING FAILURE MODE

### 5. Controlling Critical Section

Figure 4.50 shows that for the seven foot to sixteen foot subset of the 2003 culverts, CULV-5 and RISA-2D with LEFE favor the bottom slab interior corner more than half the time. The RISA-2D with spring model fails either in the wall mid-span or in the top slab interior corners.

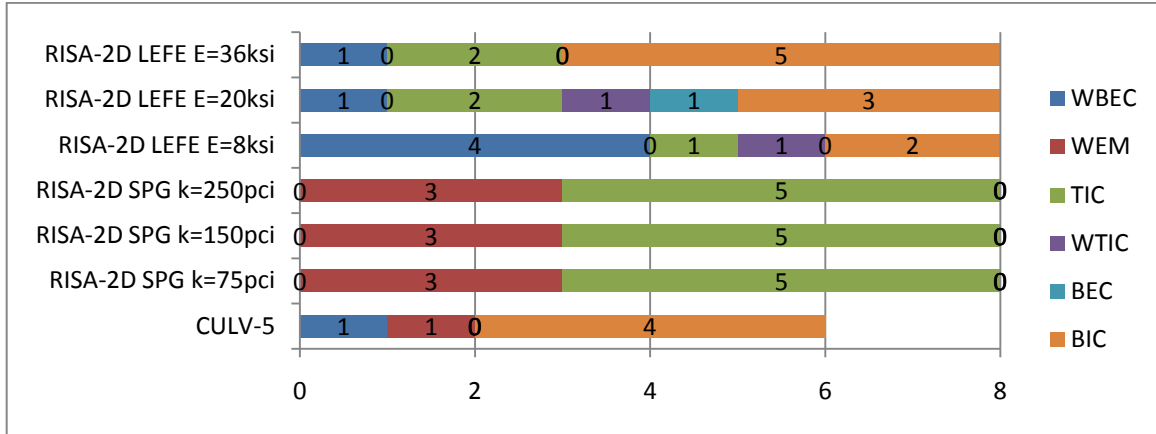

FIGURE 4.50. 2003 ERA CONTROLLING CRITICAL SECTIONS: 7' TO 16' OF FILL

For twenty feet of fill, Figure 4.51 shows that the CULV-5 model identifies the bottom slab interior corners. RISA-2D with springs evenly splits the controlling section between the wall mid-spans and the top slab interior corners. The RISA-2D with LEFE models tend to fail around the top interior corners, either in the wall or the top slab.

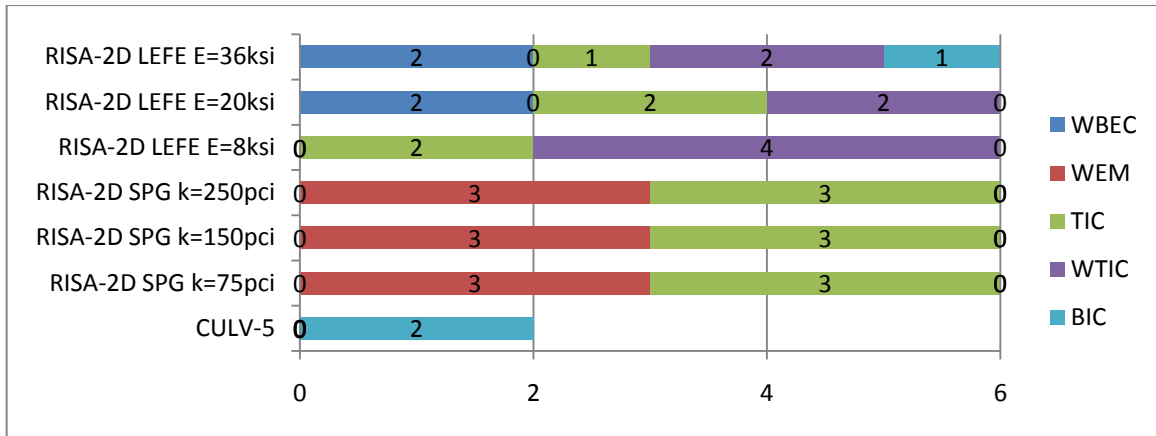

FIGURE 4.51. 2003 ERA CONTROLLING CRITICAL SECTIONS: 20' OF FILL

Figure 4.52 indicates that for the deepest fill culverts, the top interior corners are the consistently weak points, though the wall mid-span often controls in the lower order models.

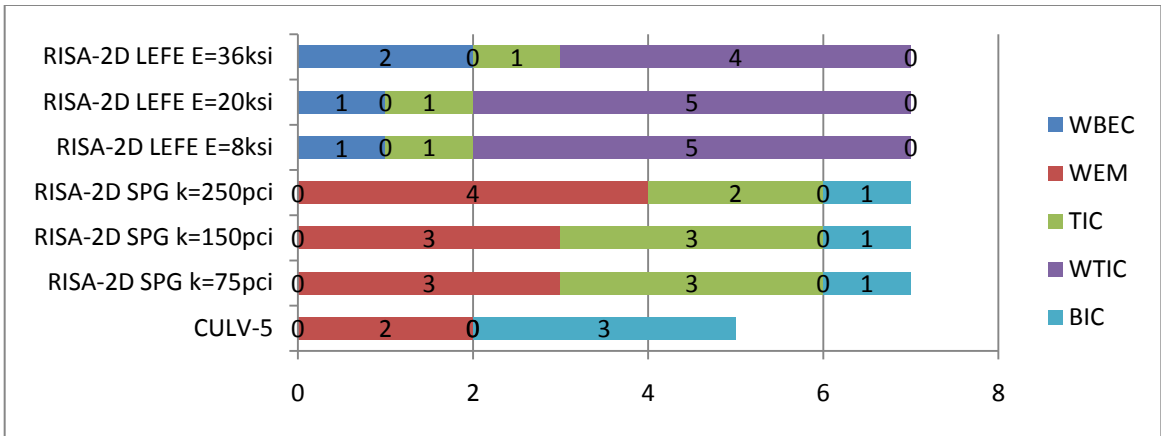

FIGURE 4.52. 2003 ERA CONTROLLING CRITICAL SECTIONS: 23' OF FILL

## 9. DISCUSSION

### 1. Evaluation of Hypotheses

#### 1. By Era

In Table 4.1, the hypotheses are shown as supported (S), unsupported (US) or indeterminate (I) relative to each era and the soil parameters selected for analysis. From this table, several generalizations can be made about the hypotheses.

TABLE 4.1. EVALUATION OF HYPOTHESES BY ERA.

ERA	INVENTORY RATING FIGURE	HYPOTHESIS 1: CULV-5 < RISA-2D SPRG			HYPOTHESIS 2: RISA-2D SPRG < RISA-2D LEFE			HYPOTHESIS 3: CULV-5 < RISA-2D LEFE		
		SPRG LOW	SPRG MEDIUM	SPRG HIGH	LEFE LOW	LEFE MEDIUM	LEFE HIGH	LEFE LOW	LEFE MEDIUM	LEFE HIGH
1938	FIGURE 4.8	S	S	S	US	S	S	US	S	S
1946	FIGURE 4.17	S	S	S	US	S	S	US	S	S
1958 36KSI	FIGURE 4.26	I	I	I	I	S	S	I	S	S
1958 60KSI	FIGURE 4.35	I	I	I	S	S	S	S	S	S
2003	FIGURE 4.44	I	I	I	US	S	S	US	S	S

The first hypothesis stated that RISA-2D with springs would produce higher ratings than CULV-5. In practice, this appears to be supported only by the oldest culverts designed in the 1938 and 1946 era. For more recent designs, no definitive trend exist to suggest that RISA-2D with springs would load rate a culvert higher or lower than CULV-5. To summarize, for culverts designed before 1958, RISA-2D with springs will probably be a slight improvement over CULV-5, but for culverts designed in 1958 or later, both programs produce similar ratings.

It is also interesting to note that the varying levels of soil stiffness in the RISA-2D with springs models do not differ greatly in the load rating they produce. A more in-depth parametric analysis would be helpful in confirming this, but it appears that generally speaking the spring stiffness does not appreciably influence the load rating. In essence, the results suggest that CULV-5 and RISA-2D with varying soil spring stiffnesses really represent a single level of reliability.

The second and third hypotheses stated that RISA-2D with LEFE would produce higher load ratings than RISA-2D with springs and CULV-5 respectively. Clearly, for medium to high modulus of soil elasticity, the hypothesis is supported. However, for low modulus values, the hypotheses are unsupported.

For RISA-2D with LEFE, the load rating is highly sensitive to the modulus of elasticity of the soil. On one hand, this can be very helpful. If a culvert fails to rate using simpler models and the culvert has excellent quality backfill, the RISA-2D with LEFE load rating



may show that the culvert rates acceptably. But it also means that for low quality fill, the RISA-2D with LEFE model may show far worse performance than the other models. The sensitivity to modulus also means that the soil modulus should be determined using field testing. A textbook value will not be sufficient to accurately load rate the culvert.

The bottom line when looking at model performance by era is simple. First, RISA-2D with springs does not produce higher load ratings often enough to be preferred over CULV-5. Second, RISA-2D with LEFE can greatly improve the load rating, if and only if the soil modulus of elasticity is high enough.

## 2. *By Depth of Fill*

Depth of fill clearly impacts load ratings, so this must be taken into account when evaluating trends. When load ratings are differentiated by depth of fill, the support or lack of support for the first hypothesis may vary. The relationships between CULV-5 and RISA-2D with spring differ from the general conclusions.

### 1. Low Depth of Fill: Direct Traffic to Two Feet

For culverts with two feet or less of fill, Table 4.2 shows the extent to which the hypotheses were supported, unsupported or indefinite.

TABLE 4.2. EVALUATION OF HYPOTHESES FOR LOW FILL CULVERTS

ERA	INVENTORY RATING FIGURE	HYPOTHESIS 1: CULV-5 < RISA-2D SPRG			HYPOTHESIS 2: RISA-2D SPRG < RISA-2D LEFE			HYPOTHESIS 3: CULV-5 < RISA-2D LEFE		
		SPRG LOW	SPRG MEDIUM	SPRG HIGH	LEFE LOW	LEFE MEDIUM	LEFE HIGH	LEFE LOW	LEFE MEDIUM	LEFE HIGH
1938	Figure 4.10	US	US	I	US	S	S	US	S	S
1946	Figure 4.19	I	I	I	US	S	S	I	I	I
1958 36KSI	Figure 4.28	S	S	S	US	S	S	I	S	S
1958 60KSI	Figure 4.37	S	S	S	S	S	S	S	S	S

By era, it has already been seen that the difference between load ratings calculated using CULV-5 were not predictably different for the ratings determined using RISA-2D with springs. However, for low fill heights, RISA-2D with springs can produce higher load ratings than CULV-5. For low fill heights, the first hypothesis is supported.

The second and third hypotheses are supported in the same manner in the low depth of fills as they are in the population at large. If the modulus of elasticity is high enough, RISA-2D with LEFE produces higher ratings than RISA-2D with springs or CULV-5.

## 2. Medium Depth of Fill Culverts: Three to Six Feet

Table 4.3 shows the evaluation of the hypotheses for medium fill culverts.

**TABLE 4.3. EVALUATION OF HYPOTHESES FOR MEDIUM FILL CULVERTS**

ERA	INVENTORY RATING FIGURE	HYPOTHESIS 1: CULV-5 < RISA-2D SPRG			HYPOTHESIS 2: RISA-2D SPRG < RISA-2D LEFE			HYPOTHESIS 3: CULV-5 < RISA-2D LEFE		
		SPRG LOW	SPRG MEDIUM	SPRG HIGH	LEFE LOW	LEFE MEDIUM	LEFE HIGH	LEFE LOW	LEFE MEDIUM	LEFE HIGH
1938	Figure 4.11	S	S	S	US	S	S	US	S	S
1938	Figure 4.12	S	S	S	US	S	S	US	S	S
1946	Figure 4.20	I	S	S	US	I	S	US	I	S
1946	Figure 4.21	S	S	S	US	S	S	US	S	S
1958 36	Figure 4.33	I	I	S	I	S	S	I	S	S
1958 36	Figure 4.34	I	I	I	I	S	S	I	S	S
1958 60	Figure 4.38	I	I	I	S	S	S	S	S	S
1958 60	Figure 4.39	I	I	I	I	S	S	I	S	S

Medium fill culverts support the hypotheses in exactly the same manner as the population at large. The first hypothesis is a split almost evenly along the era division. For the older culverts, RISA-2D with springs produces higher load ratings than CULV-5. For newer culverts RISA-2D and CULV-5 produce approximately the same load ratings. The second and third hypotheses are again only supported for medium to high soil stiffnesses. With low soil stiffness, RISA-2D with LEFE will not produce load ratings higher than RISA-2D with springs or CULV-5.

### 3. High Depth of Fill Culverts: Seven to Twenty-Three Feet

Table 4.4 shows the hypotheses as supported, unsupported or indefinitely supported for the high fill depth culverts.

**TABLE 4.4. EVALUATION OF HYPOTHESES FOR HIGH FILL CULVERTS**

ERA	INVENTORY RATING FIGURE	HYPOTHESIS 1: CULV-5 < RISA-2D SPRG			HYPOTHESIS 2: RISA-2D SPRG < RISA-2D LEFE			HYPOTHESIS 3: CULV-5 < RISA-2D LEFE		
		SPRG	SPRG	SPRG	LEFE	LEFE	LEFE	LEFE	LEFE	LEFE
		LOW	MEDIUM	HIGH	LOW	MEDIUM	HIGH	LOW	MEDIUM	HIGH
1938	Figure 4.13	I	I	I	I	S	S	I	S	S
2003	Figure 4.50	I	I	I	US	S	S	US	S	S
2003	Figure 4.51	I	I	I	US	S	S	US	S	S
2003	Figure 4.52	US	US	US	US	S	S	US	S	S

In this case, the first hypothesis is neither supported nor denied in the high fill culverts. Generally speaking CULV-5 and RISA-2D with springs produce the same ratings. However, for the deepest fill culverts, it is more likely that CULV-5 will produce the higher, less conservative load rating than RISA-2D with springs. The second and third hypotheses react in exactly the same way as before: the higher quality soil modulus produce higher ratings than CULV-5 and RISA-2D with springs, but the lowest soil modulus fails to raise the load rating.

It should be noted that the hypothesis evaluations based on depth of fill and those based on era may be identifying the same trend. Era and depth of fill are not truly independent of each other. Most of the high fill culverts are also 2003 design era. The question arises as to whether the models are providing different ratings due to design philosophy or to depth of fill. This study is not able to accurately answer that question.

### 3. *Concerns about Findings*

An issue of great concern arises from the findings of this study. Namely, if a more sophisticated model, which is assumed to be more reliable, produces lower load ratings than a less-sophisticated, less-reliable model, are the less sophisticated models unconservative? It is the responsibility of every structural engineer to design and maintain safe structures. Typically, this is accomplished by incorporating an intentional bias to overdesigning the structure. But what if the tools used are not as conservative as originally believed?

The most disturbing finding of this research is that soils with low stiffness in a finite-element, soil-structure model create worse loading conditions than the AASHTO loadings. The soil stiffness must be reliable. Though the analytical model suggests this might be the case, there are several factors not considered by the scope of this thesis. For example, how many culverts are actually backfilled with extremely low grade material? Most culverts probably have fair to excellent quality backfill, otherwise more culverts would be found to be experiencing structural distress. There is also the potential that a uniform stiffness soil mass does not accurately model soil behavior. Perhaps soil stiffness that increases with depth, as it does in reality, would actually produce the amount of reliability that is assumed within a two-dimensional, linear-elastic, soil-structural model. Needless to say, there are several concerns that will need to be addressed in future study on this issue.

## *2. Evaluations of Failure Modes*

Three different failure modes – moment, shear or thrust – could have controlled each load rating. Typically in culvert and slab design, moment is assumed to be the primary concern. This study shows that more than three-fourths of the time, this is the case. However, shear does control occasionally.

Shear controlled failures are unexpected and, in many ways, undesired. Concrete box culverts, like most concrete slab structures, are designed without shear reinforcing. Shear is only resisted by concrete strength. While moment failures in reinforced concrete are, by design, ductile failures, shear failures in concrete without shear reinforcement tend to be brittle, rapidly forming failures. This means that a culvert that fails in shear will fail suddenly and without warning. Though this is unnerving, it is comforting to realize that in the minority of culverts that are controlled by shear in the sampled designs, the load ratings are well above the required HS-20 level. So, at least for the sample of TxDOT culvert designs, shear may control from time to time, but it should not be a problem in actuality.

Also noteworthy are the classes of culverts that fail in shear. The culverts which are most likely to fail in shear are the 2003 design era and the 1958 design era with 60ksi steel. Both of the design eras use higher strength reinforcing steel. High strength reinforcing steel creates high moment capacity in relatively thin slabs. Meanwhile, the reinforcing steel does nothing for shear capacity. The only way to increase shear capacity in a slab structure is to increase the slab thickness. The primary reason that the newer culverts have a tendency to fail in shear is because the moment capacity created by better quality materials is much higher than the required capacity, but the shear capacity is relatively unimproved. It is a matter of design philosophy and material qualities.

The models used have only a slight effect on failure mode. Generally, all models have the same probability of finding shear as the controlling mode as they do of finding moment as the controlling mode. The controlling mode is much more sensitive to culvert slab design. However, in the case of the 1958 era with 60ksi steel, a trend does appear where the higher stiffness soil in the RISA-2D with LEFE models are more likely to show shear as the controlling mechanism. This is because the RISA-2D with LEFE model automatically predicts the effect called soil arching.

The soil arching effect is automatically determined in the RISA-2D with LEFE model. This phenomenon may account for shear controlling the load rating more often. The increase shear controlled failures with soil stiffness is primarily due to the fact that the stiffer soils redistribute the load more. The mid-span moment directly decreases the mid-span moment load rating, causing the relatively unaffected corner shear ratings to control.

### 3. Evaluation of Controlling Critical Sections

Table 4.5 identifies the most popular controlling critical section for each model, divided by era and depth of fill.

TABLE 4.5. PROMINENT CONTROLLING CRITICAL SECTIONS

ERA	CRITICAL SECTION FIGURE	CULV-5	RISA-2D	RISA-2D	RISA-2D	RISA-2D	RISA-2D	RISA-2D
			SPRG LOW	SPRG MEDIUM	SPRG HIGH	LEFE LOW	LEFE MEDIUM	LEFE HIGH
1938	Figure 4.15	WBIC	WBEC	WBEC	WBEC	WBEC	WTIC	WTIC
1938	Figure 4.15	WTEC/ WBEC	WBEC	WTEC/ WBEC	WTEC	WBEC	WBEC	WTIC
1938	Figure 4.15	WBEC	WBEC	WBEC	WBEC	WBEC	WBEC	WBEC
1938	Figure 4.16	WBEC	WEM BEM	WEM	WEM	WBEC	WBEC	WBEC
1946	Figure 4.23		WTIC/ WTEC	WTIC/ WTEC	WTIC/ WTEC	WTIC	WTIC	WTIC
1946	Figure 4.24	WEM	WEM/ WBEC	WEM	WEM	WBEC	WBEC	WBEC
1946	Figure 4.25	WTEC	WTEC/ WBEC	WTEC/ WBEC	WTEC	WBEC	WBEC	WBEC
1958 36	Figure 4.32	BEM	WBEC	WTEC	WTEC	BEC	WTIC	WTIC
1958 36	Figure 4.33	BEM	WBEC/ TEM	TEM	TEM	WBEC	WBEC	WTEC
1958 36	Figure 4.34	BEM/ WBEC	WBEC	WEM	WEM	WBEC	WBEC	WBEC
1958 60	Figure 4.41	BEM	WTIC	WTIC	WTIC	WTIC	WTIC	TIC
1958 60	Figure 4.42		TEM	TEM	TEM	WBEC	TIC	TIC
1958 60	Figure 4.43	BIC	TIC	WEM	WEM	WBEC	TIC	TIC
2003	Figure 4.50	BIC	TIC	TIC	TIC	WBEC	BIC	BIC
2003	Figure 4.51	BIC	TIC/ WEM	TIC/ WEM	TIC/ WEM	WTIC		
2003	Figure 4.52	BIC	TIC/ WEM	TIC/ WEM	WEM	WTIC	WTIC	WTIC

Some trends exist. The easiest trend to identify is that almost every time the controlling critical section changes from model to model. In real culverts, only one critical section controls. The actual controlling critical section should match the controlling critical section from the most reliable model. This could act as a qualitative reliability check on analytical models against actual field behavior. Comparing the controlling critical sections from field testing to the critical sections from each model would provide one check of reliability of the type of structural response, beyond simply comparing the magnitudes of the demands or ratings.

Another clear trend shows that the most popular critical sections are located at the wall corners. Particularly for RISA-2D with LEFE, the corners control almost exclusively. This is most likely due to soil arching which decreases the center span moments at the expense of corner moments and shears.

Another noteworthy trend occurs in tall, deep fill culverts. In these cases, in the CULV-5 and RISA-2D with springs models, the wall mid-span has an increased probability of controlling. Moment failures in the wall mid-spans are most strongly affected by lateral earth pressure assumptions. The sections may only control because of TxDOT's less conservative lateral earth pressure design assumptions.

## 10. CONCLUSIONS

### 1. *Reliability and Modeling Sophistication*

In this study, reliability has been defined as the coherence between predicted and observed behavior. For culvert load rating, reliability is a function of the actual behavior of the soil-structural system, accepted conservatism to account for design and construction uncertainties, and model sophistication related to load-soil-structure interaction. Within the results, the balance of actual behavior and accepted conservatism is assumed to be constant. The conclusions focus on model sophistication as a way to identify load-soil-structure interaction.

The hypotheses are intended to test the portion of reliability associated with load-soil-structure interaction as detected by model sophistication. Because uncertainty and over-conservatism are removed with each increase in modeling sophistication, it was expected that the load ratings would generally increase with increases in modeling sophistication. This research shows that though this is often the case, there are occasions where the hypotheses are not entirely supported.

### 2. *Principle Findings*

#### 1. *RISA-2D with Spring Supports will produce a higher rating than CULV-5.*

The first hypothesis predicted that RISA-2D with springs would produce higher load ratings than CULV-5. Generally speaking, this hypothesis was neither supported nor denied. RISA-2D with springs did not significantly change when the modulus of subgrade reaction increased. This suggests that CULV-5 and RISA-2D with all three spring stiffness represent the same level of reliability.

However, the hypothesis was found to be supported for older and shallow fill depth culverts. For these depths, spring supports are thought to provide more reliable and higher load ratings.

#### 2. *RISA-2D with Linear-Elastic Finite-elements (LEFE) will produce a higher rating than RISA-2D with Springs.*

The second hypothesis stated that RISA-2D with LEFE would produce higher load ratings than RISA-2D with springs. This hypothesis was only partially supported. RISA-2D with LEFE proved to be highly sensitive to the modulus of elasticity used to model the soil. For medium to high modulus values, i.e. stiffer soils, the hypothesis was easily supported. However, for the least stiff soil model with the lowest modulus values, RISA-2D with LEFE rarely produced load ratings at or above the level of RISA-2D with springs.

#### 3. *RISA-2D with LEFE will produce a higher rating than CULV-5.*

The third hypothesis claimed that RISA-2D with LEFE would produce higher load ratings than CULV-5. Because CULV-5 and RISA-2D were found to produce similar load ratings, it should be unsurprising to find that the third hypothesis was partially supported in



the same manner as the second hypothesis. For medium and high modulus values, RISA-2D with LEFE easily outclassed CULV-5. However, the low stiffness RISA-2D with LEFE model rarely produced load ratings as high as CULV-5.

### ***3. Limitations of Research***

Though this portion of the report clearly met its operational statement, one limitation should be noted. Though design era and depth of fill were identified as significant variables, the relationship between these variables and the analytical models were not completely investigated.

For example, a general trend showed that deep fill and new culverts tend to produce the same load ratings between RISA-2D with springs and CULV-5. However, depth of fill and design era are not totally independent. Are the trends really applicable to depth of fill or design era? The data from this study does not answer that question.

Another example arises when the controlling critical section and failure mode change and move between models. Is this a function of modeling methodology or design methodology? Is the model placing more stress in certain parts of the culvert or were those parts under-designed? In all likelihood the effect is created by a combination of the two, but this study fails to identify the distinction.



## 5. PARAMETRIC ANALYSIS OF SIX CULVERT VARIABLES

### 1. OVERVIEW

This chapter presents research findings from a parametric study designed to evaluate the influence of selected culvert variables on inventory rating values for a sample of seven culvert designs taken from the 100 TxDOT culvert designs discussed in Chapter 4. The research team performed this work with the following objectives in mind:

- Evaluate the sensitivity of inventory load ratings over an expected range of parameter values.
- Establish the desired level of precision necessary for the various parameters.
- Further explore trends identified when load rating the 100 culvert designs.

Table 5.1 identifies the variables of interest, the models to which they apply, the range of values considered in the parametric analyses, the untested variable assumptions, and the desired results.

**TABLE 5.1. PARAMETRIC ANALYSIS TEST MATRIX**

Variable	Model	Range				Assumptions	Conclusive result
<i>Modulus of subgrade reaction, k</i>	2	75 pci	150 pci	250 pci		LEP = 60/30 psi; DOF = max	ΔIR < 10%
<i>Poisson's ratio, ν</i>	3	0.1	0.3	0.5		Uniform E = 20ksi; DOF = max	ΔIR < 10%
<i>Multibarrel effects</i>	3	5 vs 4	6 vs 4	7 vs 4	8 vs 4	Uniform E = 20ksi; DOF = max; ν = 0.3	ΔIR < 10%
<i>Lateral earth pressures, lep</i>	1 & 2	40 pcf	60 pcf	80 pcf	100 pcf	Typ. K; DOF = max	Record ΔIR
<i>Modulus of elasticity, e</i>	3	8 ksi	20 ksi	36 ksi		Typ. N; DOF = max	Ranges where ΔIR < 10%
<i>Depth of fill, dof</i>	1, 2 & 3	Min	Mid	Max	Max +	Average typ. values for each level	Record ΔIR

**Abbreviations note:**

pci – pounds per square inch/inch (cubic inch)  
 LEP – lateral earth pressure  
 DOF – depth of fill  
 ΔIR – change in inventory rating  
 ksi – kips per square inch  
 vs – versus  
 pcf – pounds per cubic foot  
 Typ – typical  
 min – minimum  
 mid – mid-range  
 max – maximum

## 2. SAMPLE CULVERT DESIGNS

The parametric study was tested on seven culvert designs selected from the 100 culvert designs previously tested. These designs represent a “good” and a “bad” design from the 1938 era, a culvert from each fill range from the 1958 era, and two deep-fill culverts from the 2003 era. Table 5.2 shows the distribution of culvert variables for the sample.

TABLE 5.2. PARAMETRIC SAMPLE

SHEET	# OF SPANS	BARREL LENGTH, FT.	BARREL HEIGHT, FT.	SKREW (S/H)	FILL RANGE, FT.	MAX FILL HEIGHT, FT.	ORG. YEAR	ID
MBC-5-34	5	9.0	8.0	1.13	0.0	0.0	1934	MBC-5-34 5 9X8W0
MBC-1-44-F	2	5.0	4.0	1.25	0.0 - 6.0	6.0	1935	MBC-1-44-F 2 5X4W6
MC9-2	2	9.0	9.0	1.00	2.08 - 4.0	4.0	1958	MC9-2 2 9X9W4
MC6-2	6	6.0	3.0	2.00	4.08 - 6.0	6.0	1958	MC6-2 6 6X3W6
MC7-1	3	7.0	6.0	1.17	0.0 - 2.0	2.0	1958	MC7-1 3 7X6W2
MC-10-20	5	10.0	10.0	1.00	2.0 - 20.0	20.0	2003	MC-10-20 5 10X10W20
MC-7-16	4	7.0	4.0	1.75	2.0 - 16.0	16.0	2003	MC-7-16 4 7X4W16

### 3. RESULTS

#### 1. Modulus of Subgrade Reaction, $k$

##### 1. Parametric Sample

The modulus of subgrade reaction ( $k$ ) estimates the support of the soil layer below a rigid concrete slab; *e.g.*, the bottom slab of the culvert.

For a sample of 7 culvert designs, the inventory ratings were determined using three different values of the modulus of subgrade reaction. These values were chosen as representative for low quality (75 pci), medium quality (150 pci) and high quality (250 pci) soils.

##### 2. Results

Table 5.4 presents the calculated values of the inventory rating and Figure 5.1 presents plot of inventory rating with respect the modulus of subgrade reaction. As can be clearly seen in Figure 5.1, the change in rating with respect to subgrade reaction is very small. The percent difference between the inventory ratings is generally small as seen in Table 5.3. Some outliers occur when the magnitude of the rating is small, but this represents sensitivity to the percent difference calculation (smaller magnitudes result in larger percent differences) rather than sensitivity in the load rating process. For these cases the inventory rating does not change by more than HS-2 between the selected subgrade modulus values. Clearly there is very little sensitivity in the load rating to modulus of subgrade reaction as a parameter.

TABLE 5.3. PERCENT DIFFERENCE IN INVENTORY RATINGS.

ID	$\Delta IR(K)$ L TO H	$\Delta IR(K)$ L TO M	$\Delta IR(K)$ M TO H
MC-7-16 4 7X4W16	1%	0%	1%
MC6-2 6 6X3W6	2%	1%	1%
MBC-1-44-F 2 5X4W6	8%	3%	5%
MC-10-20 5 10X10W20	9%	4%	5%
MC7-1 3 7X6W2	21%	15%	7%
MC9-2 2 9X9W4	21%	10%	11%
MBC-5-34 5 9X8W0	27%	14%	15%

**TABLE 5.4. THE LOAD RATING FOR 7 REPRESENTATIVE CULVERT DESIGNS WITH THREE VARYING MODULUS OF SUBGRADE REACTION, K (PSI).**

ID	RISA-2D SPG – L – K = 75 PSI						RISA-2D SPG – M – K = 150 PSI						RISA-2D SPG - H– K = 250 PSI					
	LR	SR	WBEC	M	MIN	RLL	LR	SR	WBEC	M	MIN	RLL	LR	SR	WBEC	M	MIN	RLL
MBC-5-34 5 9X8W0	7.1	11.8	WBEC	M	MIN	RLL	8.2	13.7	WBEC	M	MIN	RLL	9.6	16.1	WBEC	M	MIN	RLL
MBC-1-44-F 2 5X4W6	39.4	65.7	WBEC	M	MIN	RLL	40.6	67.8	WBEC	M	MIN	RLL	42.6	71.1	WBEC	M	MIN	RLL
MC9-2 2 9X9W4	-3.7	-6.2	WEM	M	MAX	TL	-4.1	-6.9	WEM	M	MAX	TL	-4.7	-7.8	WEM	M	MAX	TL
MC6-2 6 6X3W6	15.8	26.3	TEM	M	MAX	RLL	15.9	26.6	TEM	M	MAX	RLL	16.1	26.9	TEM	M	MAX	RLL
MC7-1 3 7X6W2	5.8	9.7	BEM	M	MAX	RLL	6.8	11.3	BEM	M	MAX	RLL	7.3	12.2	WTIC	M	MIN	RLL
MC-10-20 5 10X10W20	-30.1	-50.3	WEM	M	MIN	TL	-31.4	-52.5	WEM	M	MIN	TL	-33.1	-55.2	WEM	M	MIN	TL
MC-7-16 4 7X4W16	58.3	97.4	TIC	V	MIN	RLL	58.3	97.3	TIC	V	MIN	RLL	58.7	98.0	TIC	V	MIN	RLL

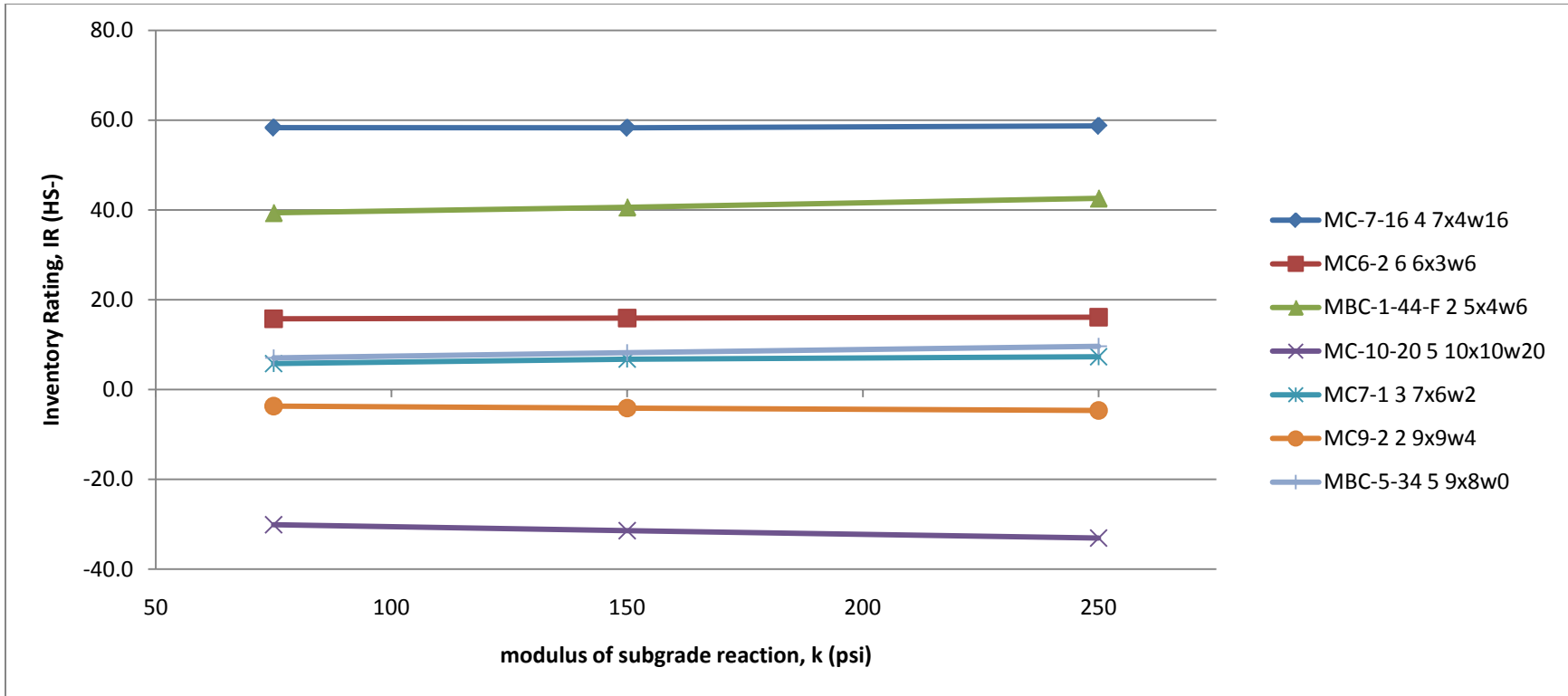

FIGURE 5.1. MODULUS OF SUBGRADE REACTION VS. THE INVENTORY RATING FOR SEVEN REPRESENTATIVE CULVERT DESIGNS.

### 3. *The Sample of 100 Culvert Designs:*

Subgrade modulus data are available from the full sample of 100 culvert designs because that task determined load ratings for each of the three subgrade modulus values. For this larger sample, the percent differences in the inventory rating values found that for the expected variation of the modulus of subgrade reaction, the percent difference between the inventory rating for the lowest k and the highest k may be larger than desired. Table 5.5 shows the number of culvert designs that satisfy the shown criteria. Again, this analysis is sensitive to the magnitude of the ratings with smaller magnitudes resulting in larger percent differences.

TABLE 5.5. NUMBER OF CULVERT DESIGNS OUT OF A SAMPLE OF 100 REPRESENTATIVE DESIGNS WHICH MEET SPECIFIC CRITERIA FOR THE MAXIMUM PERCENT DIFFERENCE IN THE INVENTORY RATING.

CRITERIA	$\Delta IR(K)$ L TO H	$\Delta IR(K)$ L TO M	$\Delta IR(K)$ M TO H
$\Delta IR(K) < 10\%$	43	66	80
$\Delta IR(K) < 20\%$	76	89	94
$\Delta IR(K) < 30\%$	89	95	96
$\Delta IR(K) < 40\%$	93	96	98

### 4. *Summary and Conclusion*

The sensitivity of the inventory rating to the modulus of subgrade reaction in the Level 2 model is small. The slope of rating versus the modulus of subgrade reaction is less than 0.02 HS-tons/pci. The percent difference between the lowest k (75 pci) and the highest k (250 pci) is less than 20% for 76 of the 100 sample culverts, and in most of the remaining culverts the difference was less than HS-2. This indicates that while the sensitivity of the inventory rating to the modulus of subgrade reaction is low, the three values for the modulus are analytically appropriate for keeping the error under control.



## 2. Poisson's Ratio

### 1. Parametric Sample

Poisson's ratio ( $\nu$ ) is the ratio, when a sample object is stretched, of the contraction or transverse strain (perpendicular to the applied load), to the extension or axial strain (in the direction of the applied load).

For a sample of 7 culvert designs, inventory ratings were determined using three different values of the Poisson's ratio and an "average" soil modulus of elasticity of 20 ksi. Poisson's ratio values of 0.5, 0.3, and 0.1 were chosen for analysis.

### 2. Results

Table 5.7 shows the calculated inventory rating values and Figure 5.2 presents a plot of the inventory rating with respect the Poisson's ratio. As can be clearly seen in Figure 5.2, the slope of the change in rating with respect to Poisson's ratio is typically very small. The percent difference between the inventory ratings is generally small as seen in Table 5.6.

TABLE 5.6. PERCENT DIFFERENCE IN INVENTORY RATINGS.

ID	$\Delta IR(N)$ L TO H	$\Delta IR(N)$ L TO M	$\Delta IR(N)$ M TO H
MC-10-20 5 10X10W20	232%	0%	232%
MC6-2 6 6X3W6	12%	7%	5%
MC-7-16 4 7X4W16	5%	1%	4%
MBC-1-44-F 2 5X4W6	6%	1%	5%
MC7-1 3 7X6W2	1%	2%	3%
MBC-5-34 5 9X8W0	12%	5%	8%
MC9-2 2 9X9W4	568%	203%	255%

One outlier, MC-10-20 5 10x10w20, occurs because for very high Poisson's ratio (low quality soil) in this tall, deeply buried culvert, the critical section moves to the midspan of the exterior wall. The rating then becomes negative.

The other outlier, MC9-2 2 9x9w4, occurs because the magnitude of the rating is small. Again, this is sensitivity to the percent difference calculation (smaller magnitudes result in larger percent differences) rather than sensitivity in the load rating process.

### 3. Conclusion

The inventory rating is not very sensitive to the Poisson's ratio, generally exhibiting less than a 10% change across the range of Poisson's ratios. For most cases, a typical value for Poisson's ratio of 0.3 provides suitable results. One exception occurs for tall culverts under significant depth of fill and which are backfilled with very poor materials; *i.e.*, highly plastic clays. For this case, it is appropriate to use a Poisson's Ratio of 0.5. But unless the soil is very poor and the culvert is tall and deeply buried, an average value for the Poisson's ratio of 0.3 is appropriate

**TABLE 5.7. THE LOAD RATING FOR 7 REPRESENTATIVE CULVERT DESIGNS WITH THREE POISSON'S RATIOS, N.**

ID	RISA-2D LEFE - N = .1					RISA-2D LEFE - N = .3					RISA-2D LEFE - N = .5				
	71.	119.			MA	71.	119.			MA	-	-			MA
MC-10-20 5 10X10W20	5	4	WTIC	M	X	7	6	WTIC	M	X	54.2	90.5	WEM	M	X
MC6-2 6 6X3W6	50.	84.7	TEM	M	MA	47.	79.3	TEM	M	MA	45.4	75.8	TEM	M	MA
MC-7-16 4 7X4W16	36.	60.6	BIC	V	MA	36.	61.0	BIC	V	MA	38.1	63.6	BIC	V	MIN
MBC-1-44-F 2 5X4W6	28.	46.7	WBEC	M	MIN	28.	47.1	WBE C	M	MIN	29.7	49.6	WBE C	M	MIN
MC7-1 3 7X6W2	12.	20.5	WTIC 1	M	MA X	12.	20.8	WTIC	M	MA X	12.1	20.2	BEC	M	MIN
MBC-5-34 5 9X8W0	6.9	11.6	WTIC	M	MA X	7.3	12.2	WTIC	M	MA X	7.9	13.2	WTIC	M	MA X
MC9-2 2 9X9W4	5.2	8.7	WBEC	M	MIN	1.7	2.9	WBE C	M	MIN	-1.1	-1.9	WBE C	M	MIN

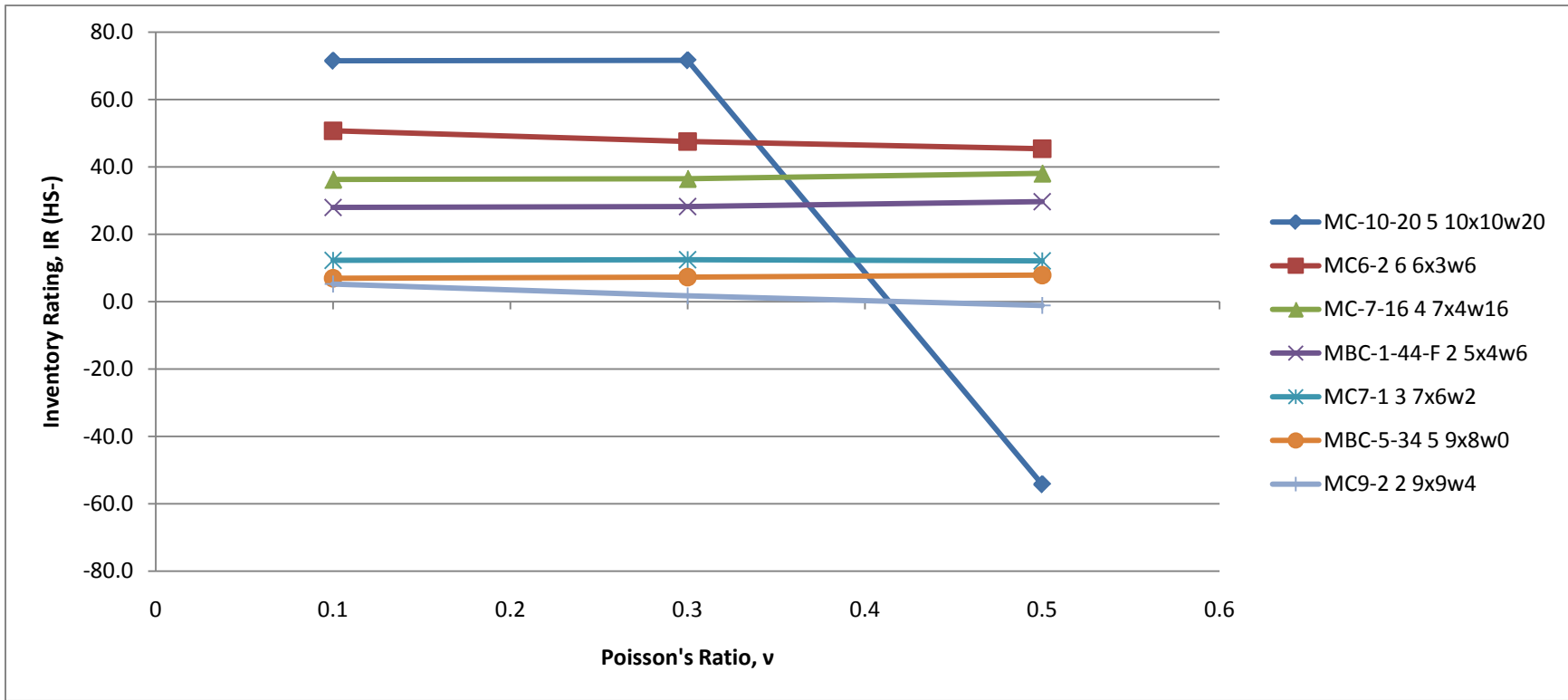

Figure 5.2. Poisson's Ratio vs. the Inventory Rating for Seven Representative Culvert Designs.

### 3. Multibarrel Effects

#### 1. Parametric Sample

One of the limitations in TxDOT’s CULV-5 program is that it cannot model culverts with more than four barrels. When TxDOT engineers encounter a culvert with more than four barrels, they analyze the culvert as if it only had four barrels, assuming this is a safe assumption. The question being addressed for this aspect of the parametric study was whether it is acceptable to model a 5+ barrel culvert as a having only 4 barrels.

For a sample of 7 culvert designs, the inventory ratings were determined using RISA-2D with LEFE for culverts having 4, 5, 6, and 7 barrels. Analyses were based on the number of barrels designed for on the appropriate design sheet. For all designs, no changes were made to dimensions or reinforcing to account for additional boxes. Analyses used a Poisson’s ratio of 0.3 and a modulus of elasticity of 20 ksi which are representative of medium quality soil.

#### 2. Results

Table 5.9 presents the calculated inventory rating values and Figure 5.3 is a plot of the inventory rating with respect the number of barrels. As can be clearly seen in Figure 5.3, the slope of the change in rating with respect to the number of barrels is very small. The percent difference between the inventory ratings is small and typically less than the 10% structural tolerance, as seen in Table 5.3.

The trends show that the 4 barrel model generally produces the lowest and most conservative rating. The only place where this trend does not hold true is for the culvert with a load rating much larger than necessary.

The other outlier, MC9-2 2 9x9w4, occurs because the magnitude of the rating is small. This represents sensitivity to the percent difference calculation (smaller magnitudes result in larger percent differences) rather than sensitivity in the load rating process.

TABLE 5.8. PERCENT DIFFERENCE IN INVENTORY RATINGS.

ID	4 BARREL	5 BARREL	6 BARREL	7 BARREL	ΔIR(K) 4 TO 5, 6, OR 7
MC-10-20 5 10X10W20	77.5	71.7	70.7	NA	-10%
MC6-2 6 6X3W6	46.8	47.1	47.5	NA	2%
MC-7-16 4 7X4W16	36.5	38.3	38.3	NA	5%
MBC-1-44-F 2 5X4W6	26.7	27.5	28.6	29.1	8%
MC7-1 3 7X6W2	12.4	12.6	12.9	NA	4%
MBC-5-34 5 9X8W0	7.4	7.3	NA	NA	-2%
MC9-2 2 9X9W4	1.1	3.3	3.1	NA	64%

### 3. *Conclusion*

The sensitivity of the inventory rating to the number of culvert barrels included in the model is small, less than a 10% change for 5, 6 and 7 barrel culverts modeled as a 4 barrel culvert. Generally this is conservative assumption. The only exceptions occur when the rating is very near zero or much greater than HS-20. This suggests it is acceptable to model 5+ barrel culverts with only 4 barrels. However, whenever possible it is preferable to model all the barrels in the culvert.

TABLE 5.9. THE LOAD RATING FOR 7 REPRESENTATIVE CULVERT DESIGNS WITH INCREASING NUMBER OF BARRELS.

ID	4 BARREL				5 BARREL				6 BARREL				7 BARREL			
	LR	WTIC	WBEC	M	LR	WTIC	WBEC	M	LR	WTIC	WBEC	M	LR	WTIC	WBEC	M
MC-10-20 5 10X10W20	77.5	129.4	WTIC	M	71.7	119.6	WTIC	M	70.7	118.1	WTIC	M	NA	NA	NA	NA
MC6-2 6 6X3W6	46.8	78.1	TEM	M	47.1	78.6	TEM	M	47.5	79.3	TEM	M	NA	NA	NA	NA
MC-7-16 4 7X4W16	36.5	61.0	BIC	V	38.3	63.9	BIC	V	38.3	64.0	BIC	V	NA	NA	NA	NA
MBC-1-44-F 2 5X4W6	26.7	44.5	WBEC	M	27.5	46.0	WBEC	M	28.6	47.7	WBEC	M	29.1	48.5	WBEC	M
MC7-1 3 7X6W2	12.4	20.6	WTIC	M	12.6	21.1	WTIC	M	12.9	21.6	WTIC	M	NA	NA	NA	NA
MBC-5-34 5 9X8W0	7.4	12.4	WTIC	M	7.3	12.2	WTIC	M	NA	NA	NA	NA	NA	NA	NA	NA
MC9-2 2 9X9W4	1.1	1.9	WBEC	M	3.3	5.5	WBEC	M	3.1	5.2	WBEC	M	NA	NA	NA	NA

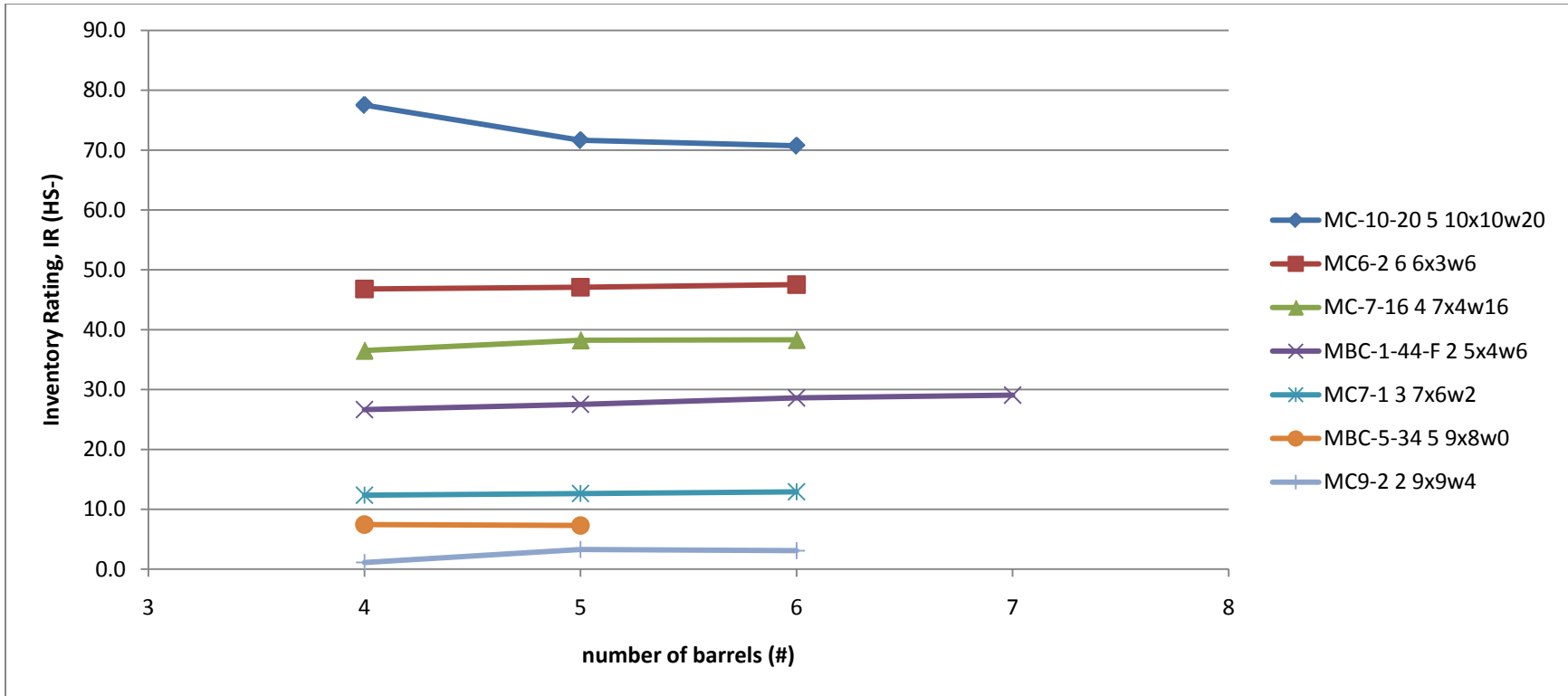

FIGURE 5.3. NUMBER OF BARRELS VS. THE INVENTORY RATING FOR SEVEN REPRESENTATIVE CULVERT DESIGNS.

#### 4. Lateral Earth Pressure, LEP

##### 1. Parametric Sample

Lateral earth pressure (LEP) is the pressure soil exerts in the horizontal plane. When calculating lateral earth pressures, engineers commonly assume the pressure distribution to be triangular and calculate the magnitude of the pressure as if the soil were an “equivalent fluid.” This calculation requires the equivalent fluid unit weight for the soil which in turn depends on soil properties, the stress history of the soil, and the characteristics of the application.

For a sample of 7 culvert designs, the inventory ratings were determined using lateral earth pressure (equivalent fluid unit weight) values ranging from 40pcf to 100pcf, varied at 20pcf increments. CULV-5 and RISA-2D with springs apply the lateral earth pressures to the culvert sidewalls, and these were the methods tested for this parameter. RISA-2D with LEFE does not apply lateral earth pressures to the culvert as loads but instead calculates soil stresses around the entire culvert subsurface regime.

##### 2. Results

Table 5.11 shows the calculated inventory rating values. Figure 5.4 and Figure 5.5 are plots of the inventory rating with respect the lateral earth pressure (equivalent fluid unit weight) values. These plots show that unless the inventory rating becomes negative, the load rating is not particularly sensitive to the lateral earth pressure value. Negative ratings occur in tall culverts because the critical section moves to the exterior wall mid-spans.

Table 5.10 shows the change in the inventory rating and the percent change in the inventory rating. It is clear that unless the inventory rating is very small or negative, the lateral earth pressure does not significantly affect the load rating.

TABLE 5.10. CHANGE IN INVENTORY RATING AND PERCENT DIFFERENCE IN INVENTORY RATING.

RATING DATA ID	CULV-5		RISA-2D	
	DIFFERENCE (HS-TONS)	PERCENT DIFFERENCE	DIFFERENCE (HS-TONS)	PERCENT DIFFERENCE
MC-7-16 4 7X4W16	-5.1	-9%	-5.0	-9%
MBC-1-44-F 2 5X4W6	1.2	4%	3.8	10%
MC6-2 6 6X3W6	-0.7	-6%	-0.7	-5%
MBC-5-34 5 9X8W0	-0.5	-9%	-0.6	-8%
MC7-1 3 7X6W2	1.0	25%	2.7	41%
MC-10-20 5 10X10W20	123.1	334%	78.3	-1015%
MC9-2 2 9X9W4	638.0	8119%	139.2	1222%



### 3. *Conclusion*

The sensitivity of the load rating to the lateral earth pressure is surprisingly small. Lateral earth pressures appear to only affect tall sidewall culverts, and as such produce negative load ratings where the magnitude of the rating does not have numerical significance (failure under dead load). Because lateral earth pressures matter very little when determining load ratings, it is logical to use the AASHTO requirement of 60pcf. The AASHTO values are reasonable, approved, and provide liability protection.

**TABLE 5.11. THE LOAD RATING FOR  
SEVEN REPRESENTATIVE CULVERT DESIGNS WITH INCREASING LATERAL EARTH PRESSURE.**

ID	CULV-5 LEP = 40PSF					CULV-5 LEP = 60PSF					CULV-5 LEP = 80PSF					CULV-5 LEP = 100PSF				
MBC-5-34 5 9X8W0	5.7	9.6	BIC	M	RLL	5.9	9.9	BIC	M	RLL	6.1	10.2	BIC	M	RLL	6.3	10.5	BIC	M	RLL
MBC-1-44-F 2 5X4W6	28.4	47.4	WBEC	M	TL	27.9	46.6	WBEC	M	TL	27.1	45.3	WBEC	M	TL	27.1	45.3	WBEC	M	TL
MC9-2 2 9X9W4	7.9	13.1	BEM	M	RLL	-2.9	-4.8	WEM	M	TL	-13.3	-22.2	WEM	M	TL	-630.2	-1051.9	WEM	M	TL
MC6-2 6 6X3W6	13.2	22.0	BEM	M	RLL	13.4	22.4	BEM	M	RLL	13.7	22.8	BEM	M	RLL	13.9	23.2	BEM	M	RLL
MC7-1 3 7X6W2	4.2	7.0	BEM	M	RLL	4.3	7.2	BEM	M	RLL	4.5	7.5	BEM	M	RLL	3.2	5.3	WEM	M	TL
MC-10-20 5 10X10W20	36.9	61.5	BIC	V	RLL	-29.2	-48.7	WEM	M	TL	-66.0	-110.1	WEM	M	TL	-86.2	-143.9	WEM	M	TL
MC-7-16 4 7X4W16	53.5	89.3	BIC	V	RLL	55.2	92.1	BIC	V	TL	56.8	94.9	BIC	V	RLL	58.5	97.7	BIC	V	RLL

ID	RISA-2D LEP = 40PSF					RISA-2D LEP = 60PSF					RISA-2D LEP = 80PSF					RISA-2D LEP = 100PSF				
MBC-5-34 5 9X8W0	7.6	12.7	WBEC	M	RLL	8.2	13.7	WBEC	M	RLL	8.0	13.3	WBEC	M	RLL	8.2	13.6	WBEC	M	RLL
MBC-1-44-F 2 5X4W6	39.4	65.8	WBEC	M	RLL	40.6	67.8	WBEC	M	RLL	41.8	69.8	WBEC	M	RLL	35.6	59.4	WEM	M	TL
MC9-2 2 9X9W4	11.4	19.0	TEM	M	RLL	-4.1	-6.9	WEM	M	TL	-14.7	-24.6	WEM	M	TL	-127.8	-213.3	WEM	M	TL
MC6-2 6 6X3W6	15.7	26.2	TEM	M	RLL	15.9	26.6	TEM	M	RLL	16.2	27.0	TEM	M	RLL	16.4	27.4	TEM	M	RLL
MC7-1 3 7X6W2	6.6	11.1	BEM	M	RLL	6.8	11.3	BEM	M	RLL	6.3	10.6	BEC	M	TL	3.9	6.6	WEM	M	TL
MC-10-20 5 10X10W20	-7.7	-12.9	WBEC	V	TL	-31.4	-52.5	WEM	M	TL	-66.5	-111.0	WEM	M	TL	-86.0	-143.6	WEM	M	TL
MC-7-16 4 7X4W16	56.7	94.6	TIC	V	RLL	58.3	97.3	TIC	V	RLL	60.0	100.1	TIC	V	RLL	61.7	102.9	TIC	V	RLL

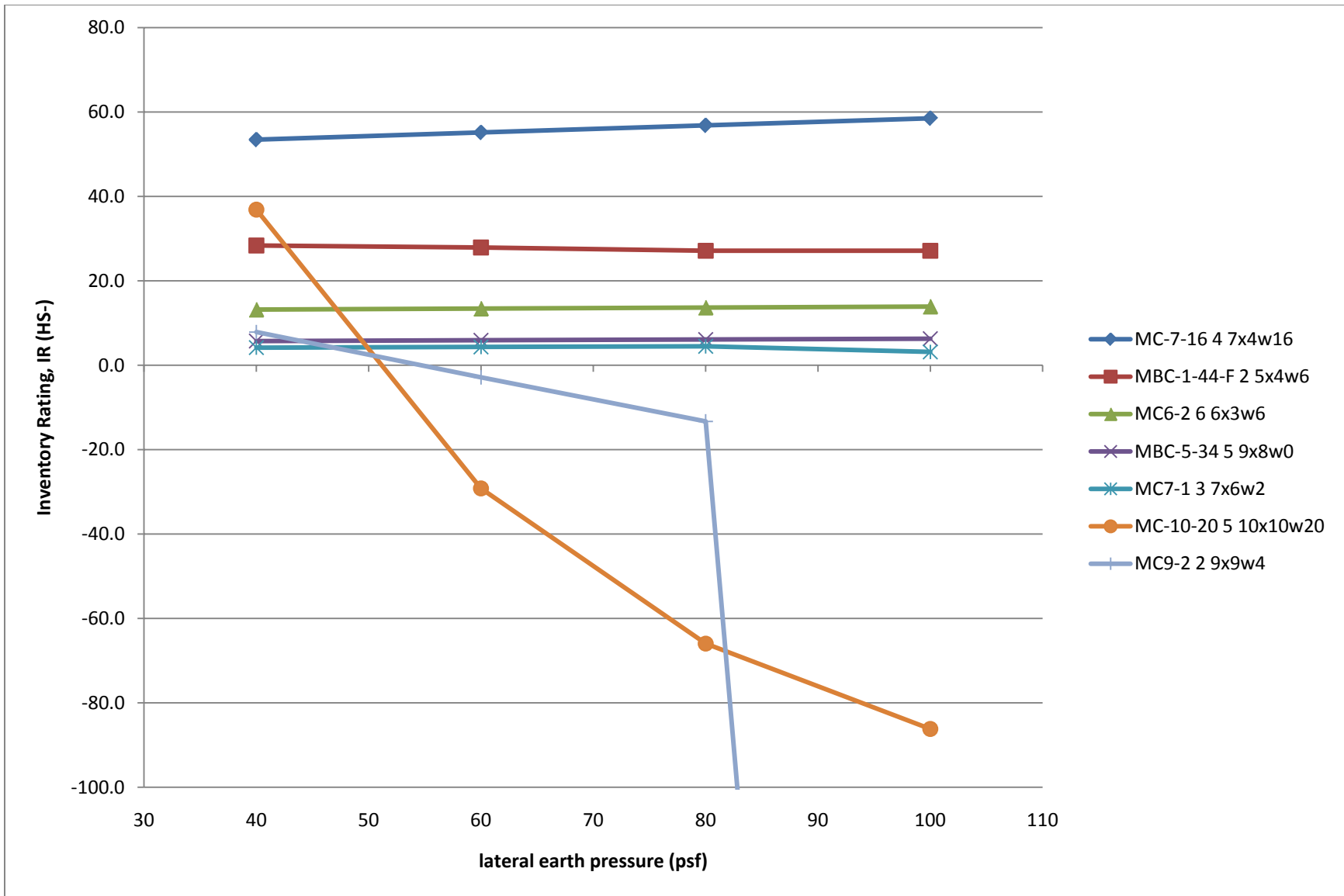

FIGURE 5.4. LATERAL EARTH PRESSURE VS. THE INVENTORY RATING FOR SEVEN REPRESENTATIVE CULVERT DESIGNS USING CULV-5.

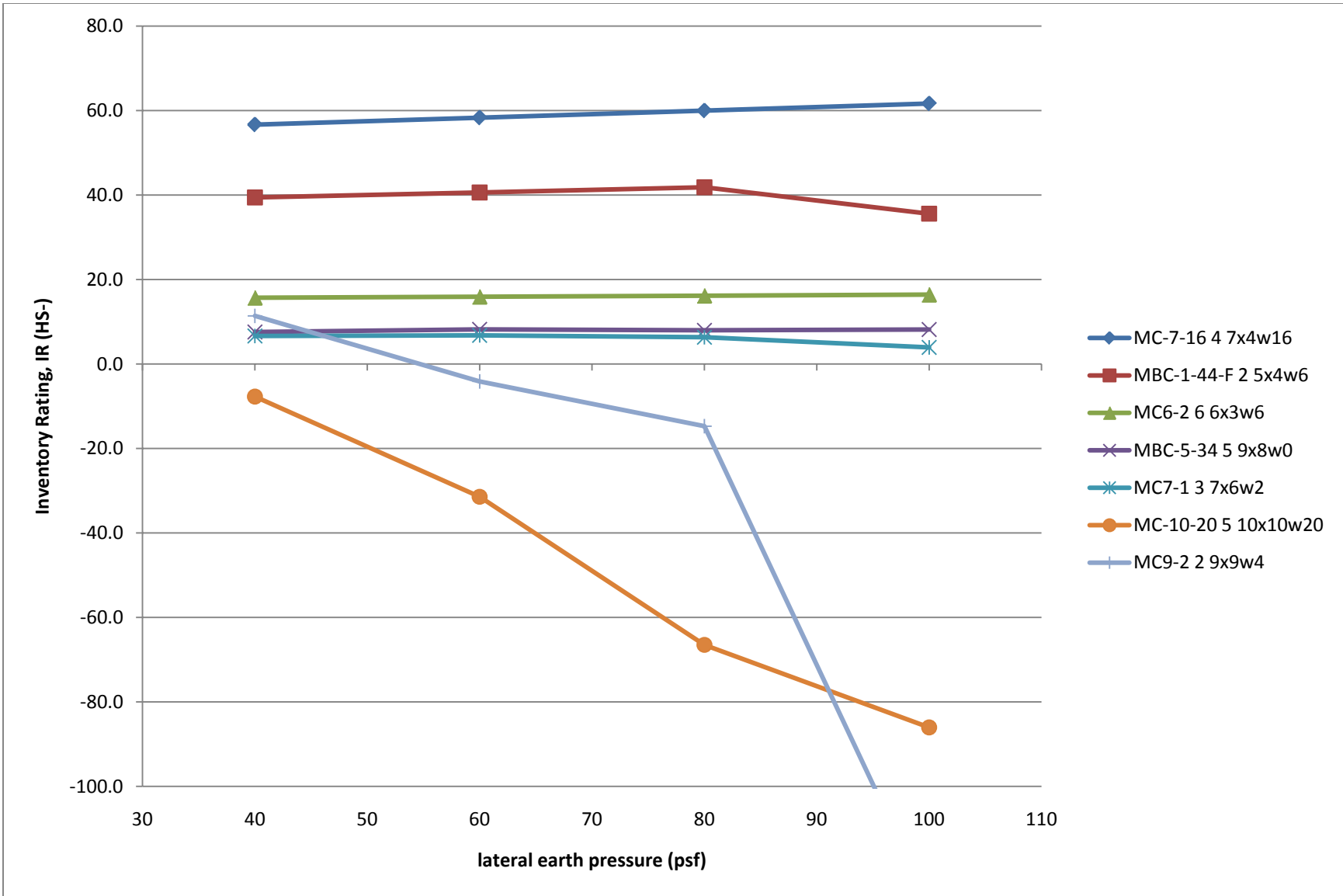

FIGURE 5.5. LATERAL EARTH PRESSURE VS. INVENTORY RATING FOR SEVEN REPRESENTATIVE CULVERT DESIGNS USING RISA-2D.MODULUS OF ELASTICITY, E

### *1. Parametric Sample*

The modulus of elasticity for a material is basically the slope of its stress-strain plot within the elastic range. Sometimes called Young's modulus, the elastic modulus (E) can be determined for any solid material and represents a constant ratio of stress and strain (a stiffness).

For a sample of 7 culvert designs, the inventory ratings were determined using a modulus of elasticity ranging from 4 ksi to 40 ksi by intervals of 4 ksi. This parameter only applies to the RISA-2D with LEFE model, as it uses a linear-elastic constitutive soil model. Poisson's ratio of 0.3 was selected for all analyses.

### *2. Results*

Table 5.13 presents the calculated inventory rating values. Figure 5.6 presents a plot of the inventory rating with respect the modulus of elasticity.

The clearest trend observed is that greater depths of fill show greater sensitivity to modulus of elasticity. This means that for deeper culverts it is more important to accurately identify the actual modulus.

Figure 5.6 shows that the relationship between modulus and inventory rating is not linear. However, linear approximations of the slopes between measured points can be used to estimate the required precision in modulus to determine the inventory rating to within HS-2 (10% of the design load, HS-20). Using this approach, Table 5.12 shows the average and maximum slope values and the average and worst-case tolerances required for each of the analyzed culverts. This analysis indicates that for inventory rating calculations to be reliable, the modulus of elasticity must be known with a high degree of precision.

**TABLE 5.12. REQUIRED CONFIDENCE FOR MODULUS OF ELASTICITY, E.**

<b>ID</b>	<b>AVERAGE SLOPE (HS-TONS/KSI)</b>	<b>MAX SLOPE (HS-TONS/KSI)</b>	<b>AVERAGE REQUIRED CONFIDENCE (KSI)</b>	<b>WORST-CASE REQUIRED CONFIDENCE (KSI)</b>
MC-7-16 4 7X4W16	5.9	9.3	0.34	0.21
MC-10-20 5 10X10W20	7.4	11.4	0.27	0.18
MC6-2 6 6X3W6	1.3	3.1	1.49	0.64
MBC-1-44-F 2 5X4W6	1.2	1.3	1.70	1.54
MC9-2 2 9X9W4	1.2	1.7	1.60	1.17
MC7-1 3 7X6W2	0.5	1.2	3.94	1.71
MBC-5-34 5 9X8W0	0.4	1.2	5.65	1.62

More specifically, Table 5.12 suggests it would not be unreasonable to say that the soil modulus must be identified to within  $\pm 200$  psi for fill depths greater than 6 ft and  $\pm 1000$  psi for fill depths less than 6 ft. This is very high precision for geotechnical work.

### 3. Conclusion

The modulus of elasticity greatly and directly affects the inventory rating. For higher fill depths the influence of soil modulus on load rating is even more pronounced. To control error in load rating calculations to within 10% according to structural tolerance ( $\pm$ HS-2), the modulus of elasticity should be identified to within  $\pm$ 200 psi for high fill depths (more than 6 ft of fill) and  $\pm$ 1000 psi for low fill depths (less than 6 ft of fill).

Much can be said about the challenge of achieving a reasonable degree of precision for the soil elastic modulus value. Soils are highly variable, their strength properties are stress-dependent, and these properties can vary over time. All of the uncertainties and errors associated with geotechnical sampling and testing come into play. Further, the soil modulus parameter can be obtained by multiple methods, ranging from the selection of tabulated “textbook” values to site-specific determination through in-situ tests. These factors suggest that the selection of soil modulus values for culvert load rating purposes can introduce significant uncertainty into the calculation.

**TABLE 5.13. THE LOAD RATING FOR SEVEN REPRESENTATIVE CULVERT DESIGNS WITH INCREASING MODULUS OF ELASTICITY.**

ID	E = 4 KSI				E = 8 KSI				E = 12 KSI				E = 16 KSI				E = 20 KSI			
MC-7-16 4 7X4W16	14.4	24.0	WTIC	M	51.7	86.3	WTIC	M	81.4	135.9	WTIC	M	107.0	178.6	WTIC	M	130.9	218.6	WTIC	M
MC-10-20 5 10X10W20	-69.9	-116.8	WTIC	M	-24.3	-40.6	WTIC	M	11.5	19.2	WTIC	M	42.8	71.5	WTIC	M	71.7	119.6	WTIC	M
MC6-2 6 6X3W6	12.3	20.6	WBEC	M	24.9	41.5	WBEC	M	32.7	54.6	TEM	M	40.1	66.9	TEM	M	47.5	79.3	TEM	M
MBC-1-44-F 2 5X4W6	8.7	14.4	WBEC	M	13.8	23.1	WBEC	M	18.8	31.3	WTIC	M	23.6	39.3	WBEC	M	28.2	47.1	WBEC	M
MC9-2 2 9X9W4	-21.4	-35.8	WBEC	M	-14.6	-24.3	WBEC	M	-8.7	-14.4	WTIC	M	-3.3	-5.5	WBEC	M	1.7	2.9	WBEC	M
MC7-1 3 7X6W2	-1.5	-2.5	BEC	M	3.1	5.3	BEC	M	6.9	11.5	WBEC	M	10.0	16.7	WBEC	M	12.5	20.8	WTIC	M
MBC-5-34 5 9X8W0	-2.5	-4.2	WTIC	M	2.4	4.0	WTIC	M	5.1	8.5	WTIC	M	6.6	11.1	WTIC	M	7.3	12.2	WTIC	M

ID	E = 24 KSI				E = 28 KSI				E = 32 KSI				E = 36 KSI				E = 40 KSI			
MC-7-16 4 7X4W16	153.0	255.5	WTIC	M	173.5	289.6	WTIC	M	193.5	323.1	WTIC	M	211.9	353.7	BIC	V	226.5	378.1	BIC	V
MC-10-20 5 10X10W20	98.1	163.7	WEM	M	121.0	201.9	WEM	M	146.1	243.9	WEM	M	173.5	289.6	WTIC	M	196.8	328.5	WTIC	M
MC6-2 6 6X3W6	52.9	88.3	TIC	V	55.0	91.9	TIC	V	57.1	95.3	TIC	V	59.0	98.4	TIC	V	60.6	101.2	TIC	V
MBC-1-44-F 2 5X4W6	32.9	54.9	WBEC	M	37.5	62.6	WBEC	M	41.9	70.0	WBEC	M	46.6	77.7	WBEC	M	51.0	85.1	WBEC	M
MC9-2 2 9X9W4	6.5	10.8	WBEC	M	11.0	18.3	WBEC	M	15.3	25.6	WBEC	M	19.5	32.6	WBEC	M	23.6	39.4	WBEC	M
MC7-1 3 7X6W2	13.7	22.9	WTIC	M	14.9	24.9	WTIC	M	15.9	26.6	WTEC	M	16.4	27.4	WTEC	M	16.8	28.0	WTEC	M
MBC-5-34 5 9X8W0	8.5	14.1	WTIC	M	9.0	15.1	WTIC	M	9.5	15.9	WTIC	M	9.9	16.5	WTIC	M	10.2	17.0	WTIC	M



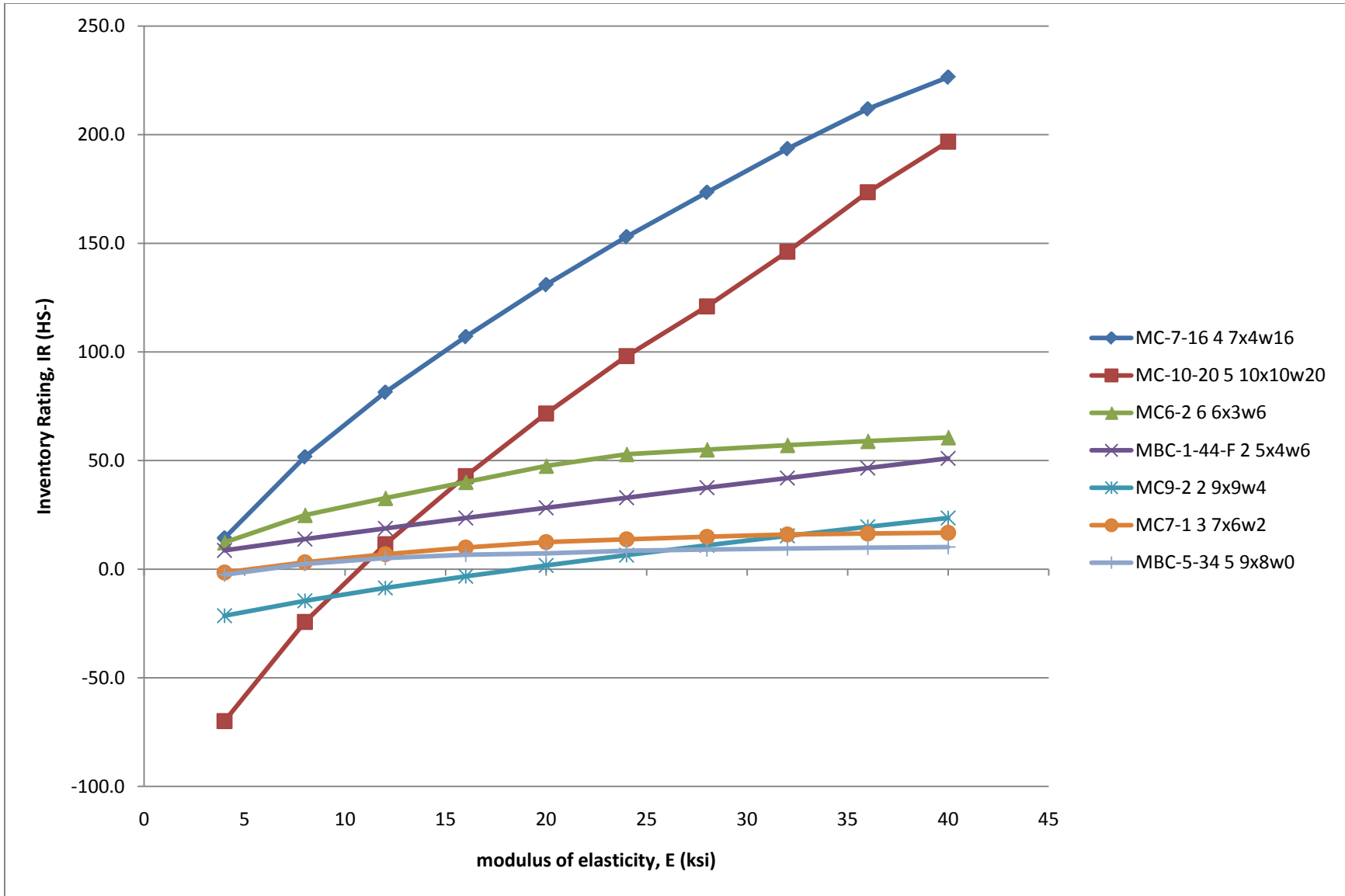

FIGURE 5.6. MODULUS OF ELASTICITY VS. THE INVENTORY RATING FOR SEVEN REPRESENTATIVE CULVERT DESIGNS.

## **5. *Depth of Fill***

### **1. *Parametric Sample***

The depth of fill refers to the amount of overburden soil above the culvert top slab. Direct traffic culverts are those with less than 2 feet of fill, and deep-fill culverts are those with more than six feet of fill. Culvert designs typically are specified relative to a maximum fill depth. However, situations arise, such as in roadway rehabilitation projects, where it becomes desirable to increase the depth of fill above the design amount, or to lessen the depth of fill. The question being addressed with this parameter is, what influence does the depth of fill have on the culvert inventory rating.

For a sample of seven culvert designs, the inventory ratings were determined five times for each culvert at four different fill depths. Four depths of fill were chosen for each culvert to represent the minimum and maximum design depth, an average between the two and an overload depth. No increments of less than 2ft were used. Analytical models included CULV-5 with AASHTO lateral earth pressures, RISA-2D with springs with a modulus of subgrade reaction of 150psi and AASHTO lateral earth pressures, and RISA-2D with LEFE using a Poisson's ratio of 0.3 and soil modulus values of 8ksi, 20ksi and 30ksi. These were chosen to portray the range of model abilities and soil qualities.

### **2. *Results***

Table 5.14 presents the calculated inventory rating values for different depths of fill. Figure 5.7 through Figure 5.13 are plots of the inventory rating with respect to the depth of fill.

Several observations may be made from these data. First, the data emphasize the sensitivity of the relationship between modulus of elasticity and depth of fill. As the depth of fill increases, the sensitivity to changes in the modulus of elasticity also increases.

Second, typically the highest rating occurs when the depth of fill is at the maximum design depth. At this depth, the culvert is precisely designed for the dead load, and the live load is most dissipated.

Third, it is clear that just because a culvert rates well for maximum fill, it may not rate as well for the minimum fill. Though the dead load is less for the minimum fill, the live load may be exponentially larger. There is less fill to dissipate the live loads.

Fourth, typically, the intermediate fill depths produce load ratings in between the maximum and minimum values.

Fifth, it appears that culverts may have some capacity for overload fill depths, though this may be highly dependent upon soil properties.

**TABLE 5.14. THE LOAD RATING FOR SEVEN REPRESENTATIVE CULVERT DESIGNS WITH INCREASING DEPTH OF FILL.**

ID	LVL 1: MIN					LVL 1: AVERAGE					LVL 1: MAX					LVL 1: OVERLOAD				
MC-7-16 4 7X4W16	16.1	26.8	WTIC	M	RLL	81.1	135.3	WTIC	M	RLL	55.2	92.1	BIC	V	RLL	-242.3	-404.5	BIC	V	TL
MC-10-20 5 10X10W20	9.9	16.6	WEM	M	TL	-4.2	-7.1	WEM	M	TL	-29.2	-48.7	WEM	M	RLL	-7761.4	-12955.6	BIC	V	TL
MC6-2 6 6X3W6	14.5	24.3	BEM	M	RLL	13.4	22.4	BEM	M	RLL	4.6	7.7	BEM	M	RLL	-11.9	-19.8	BEM	M	RLL
MBC-1-44-F 2 5X4W6	9.9	16.5	WBEC	M	TL	16.3	27.2	WBEC	M	TL	27.9	46.6	WBEC	M	TL	23.6	39.4	WBEC	M	TL
MC9-2 2 9X9W4	-0.9	-1.4	WEM	M	TL	-2.9	-4.8	WEM	M	TL	-16.3	-27.2	WBEC	M	TL	-41.4	-69.1	WBEC	M	TL
MC7-1 3 7X6W2	6.2	10.4	BEM	M	RLL	4.3	7.2	BEM	M	RLL	3.0	5.0	BEM	M	RLL	-4.8	-8.1	BEM	M	RLL
MBC-5-34 5 9X8W0	5.9	9.9	BIC	M	RLL	1.7	2.9	BIC	M	RLL	-5.4	-9.1	BIC	M	RLL	-19.8	-33.1	BIC	M	RLL

ID	LVL 2: MIN					LVL 2: AVERAGE					LVL 2: MAX					LVL 2: OVERLOAD				
MC-7-16 4 7X4W16	10.1	16.9	WTIC	M	RLL	77.2	128.9	WTIC	M	RLL	58.3	97.3	TIC	V	RLL	-134.2	-224.0	TIC	V	TL
MC-10-20 5 10X10W20	12.8	21.4	WEM	M	TL	-4.9	-8.2	WEM	M	TL	-31.4	-52.5	WEM	M	TL	-4788.3	-7992.8	TIC	V	TL
MC6-2 6 6X3W6	15.8	26.3	TEM	M	RLL	15.9	26.6	TEM	M	RLL	8.8	14.7	TEM	M	RLL	-10.5	-17.6	TEM	M	RLL
MBC-1-44-F 2 5X4W6	16.7	27.9	WBEC	M	RLL	20.7	34.6	WBEC	M	RLL	40.6	67.8	WBEC	M	RLL	53.3	88.9	WBEC	M	RLL
MC9-2 2 9X9W4	-1.5	-2.6	WEM	M	TL	-4.1	-6.9	WEM	M	TL	-81.8	-136.5	WEM	M	TL	-49.1	-81.9	WBEC	M	TL
MC7-1 3 7X6W2	7.5	12.5	WTIC	M	TL	6.5	10.9	BEM	M	RLL	6.9	11.6	BEM	M	RLL	-0.9	-1.5	BEM	M	RLL
MBC-5-34 5 9X8W0	7.8	13.0	WBEC	M	RLL	6.5	10.8	WBEC	M	RLL	9.2	15.3	WBEC	M	RLL	0.6	0.9	BIC	M	RLL

TABLE 5.14. THE LOAD RATING FOR SEVEN REPRESENTATIVE CULVERT DESIGNS WITH INCREASING DEPTH OF FILL. (CONT).

ID	LVL 3: E=8KSI: MIN				LVL 3: E=8KSI: AVERAGE				LVL 3: E=8KSI: MAX				LVL 3: E=8KSI: OVERLOAD			
MC-7-16 4 7X4W16	11.3	18.9	WTIC	M	-35.8	-59.7	WTIC	M	51.7	86.3	WTIC	M	-8.6	-14.3	TIC	V
MC-10-20 5 10X10W20	0.5	0.8	WTIC	M	-10.7	-17.9	WTIC	M	-24.3	-40.6	WTIC	M	-2982.5	-4978.5	BEC	V
MC6-2 6 6X3W6	21.1	35.3	TEM	M	24.9	41.5	WBEC	M	16.5	27.6	WBEC	M	4.7	7.8	WBEC	M
MBC-1-44-F 2 5X4W6	8.9	14.9	WBEC	M	12.3	20.6	WBEC	M	13.8	23.1	WBEC	M	5.9	9.8	WBEC	M
MC9-2 2 9X9W4	-3.1	-5.2	WBEC	M	-14.6	-24.3	WBEC	M	-27.1	-45.2	WBEC	M	-1435.7	-2396.6	BEM	M
MC7-1 3 7X6W2	6.1	10.2	WTIC	M	3.1	5.3	BEC	M	-2.5	-4.1	WBEC	M	-12.1	-20.1	WBEC	M
MBC-5-34 5 9X8W0	2.5	4.2	WTIC	M	-1.5	-2.5	WBEC	M	-11.5	-19.2	WBEC	M	-24.1	-40.3	WBEC	M

ID	LVL 3: E=20KSI: MIN				LVL 3: E=20KSI: AVERAGE				LVL 3: E=20KSI: MAX				LVL 3: E=20KSI: OVERLOAD			
MC-7-16 4 7X4W16	16.0	26.7	WTIC	M	32.2	53.7	WTIC	M	130.9	218.6	WTIC	M	68.9	115.0	TIC	V
MC-10-20 5 10X10W20	11.8	19.7	WTIC	M	41.5	69.3	WTIC	M	71.7	119.6	WTIC	M	-72.6	-121.2	WEM	M
MC6-2 6 6X3W6	33.6	56.0	TEM	M	47.5	79.3	TEM	M	46.9	78.3	WBEC	M	35.9	60.0	WBEC	M
MBC-1-44-F 2 5X4W6	12.4	20.7	WBEC	M	20.2	33.7	WBEC	M	28.2	47.1	WBEC	M	21.4	35.8	WBEC	M
MC9-2 2 9X9W4	7.3	12.1	WBEC	M	1.7	2.9	WBEC	M	-10.0	-16.8	WBEC	M	-25.2	-42.1	WBEC	M
MC7-1 3 7X6W2	8.3	13.9	WTIC	M	12.5	20.8	WTIC	M	12.8	21.4	WBEC	M	4.3	7.3	WBEC	M
MBC-5-34 5 9X8W0	7.7	12.8	WTIC	M	9.3	15.5	WTIC	M	12.4	20.7	WBEC	M	3.2	5.3	WBEC	M

ID	LVL 3: E=36KSI: MIN				LVL 3: E=36KSI: AVERAGE				LVL 3: E=36KSI: MAX				LVL 3: E=36KSI: OVERLOAD			
MC-7-16 4 7X4W16	18.9	31.5	WTIC	M	89.7	149.7	WTIC	M	211.9	353.7	BIC	V	156.2	260.8	BIC	V
MC-10-20 5 10X10W20	18.4	30.7	WTIC	M	92.8	155.0	WTIC	M	173.5	289.6	WTIC	M	14.5	24.3	WEM	M
MC6-2 6 6X3W6	48.6	81.2	TIC	V	59.0	98.4	TIC	V	58.6	97.9	BIC	V	49.8	83.1	BIC	V
MBC-1-44-F 2 5X4W6	14.8	24.7	TIC	M	30.0	50.0	WBEC	M	46.6	77.7	WBEC	M	40.7	67.9	WBEC	M
MC9-2 2 9X9W4	15.5	25.8	TEM	M	19.5	32.6	WBEC	M	10.0	16.6	WBEC	M	-3.7	-6.1	WBEC	M
MC7-1 3 7X6W2	8.9	14.9	WTIC	M	16.4	27.4	WTEC	M	28.7	47.8	WBEC	M	21.9	36.6	WBEC	M
MBC-5-34 5 9X8W0	9.9	16.5	WTIC	M	13.6	22.6	WTIC	M	32.0	53.4	WTIC	M	37.0	61.8	WBEC	M

FIGURE 5.7. INVENTORY RATING VS. DEPTH OF FILL FOR MC-7-16 4 7X4W16.

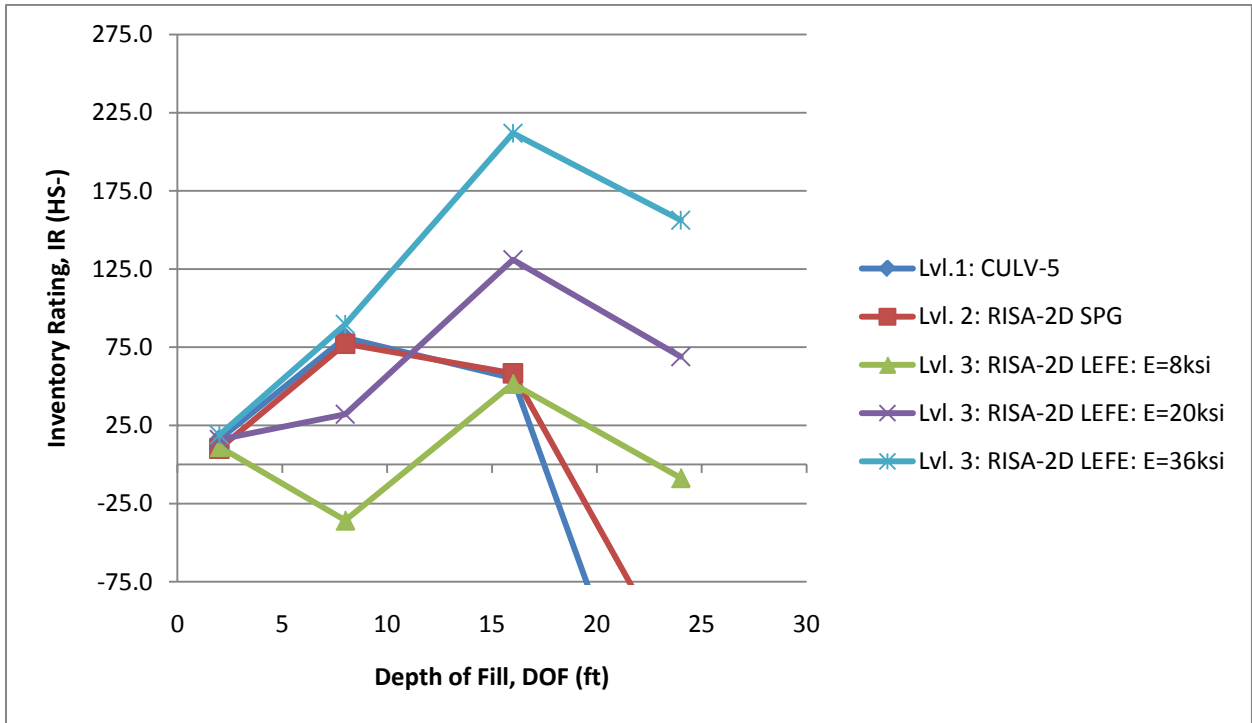

FIGURE 5.8. INVENTORY RATING VS. DEPTH OF FILL FOR MC-10-20 5 10X10W20.

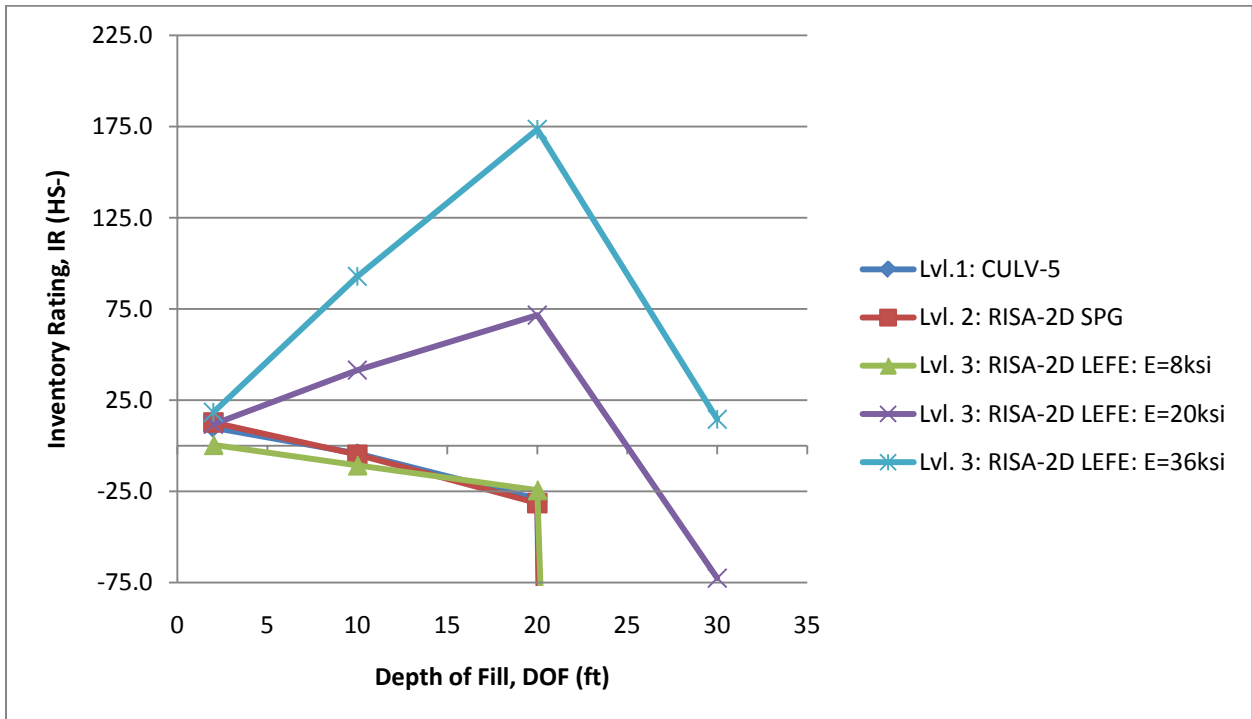

FIGURE 5.9. INVENTORY RATING VS. DEPTH OF FILL FOR MC7-1 3 7X6W2.

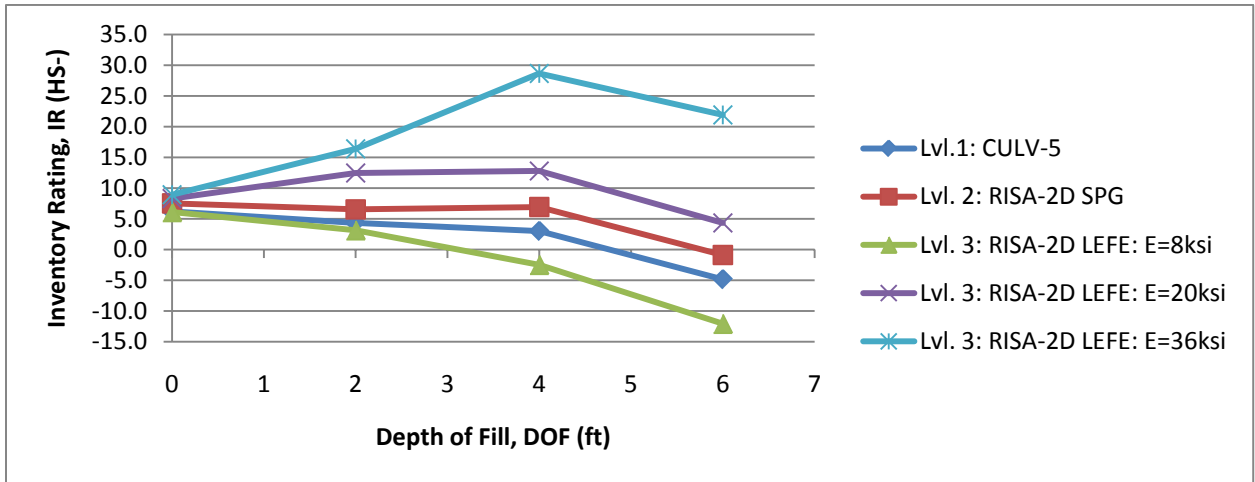

FIGURE 5.10. INVENTORY RATING VS. DEPTH OF FILL FOR MC9-2 2 9X9W4.

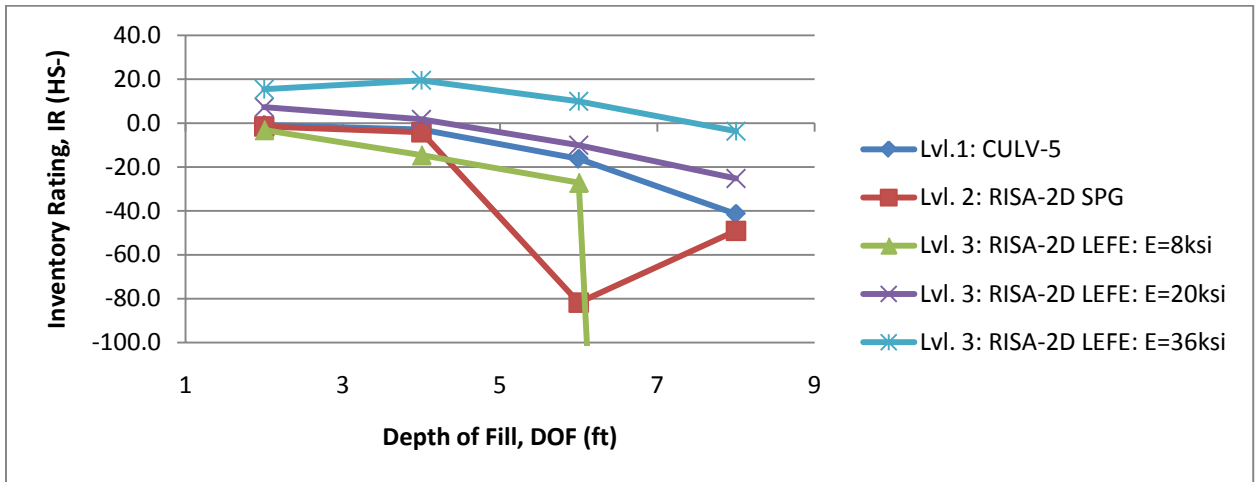

FIGURE 5.11. INVENTORY RATING VS. DEPTH OF FILL FOR MC6-2 6 6X3W6.

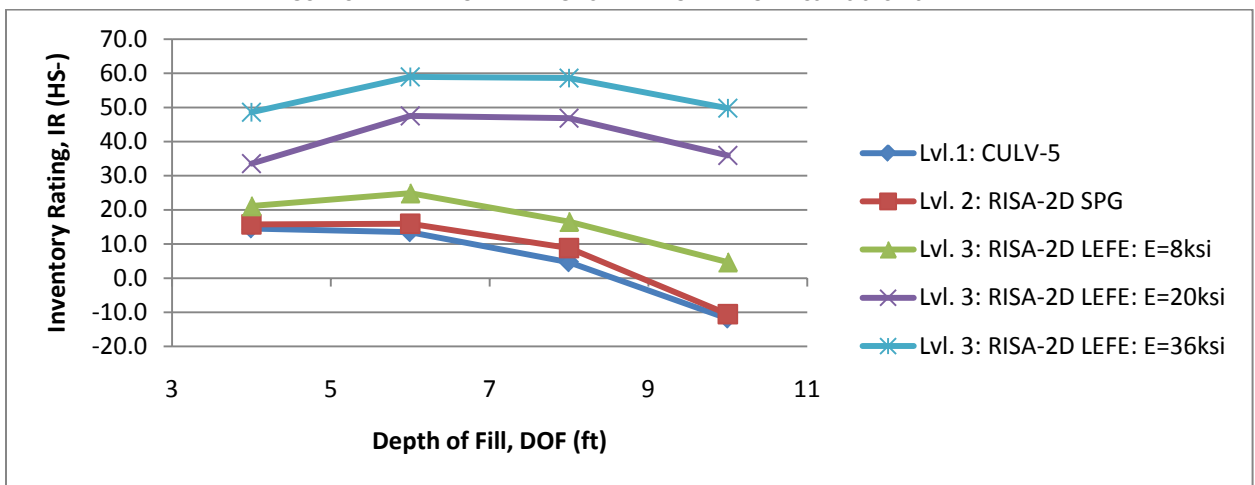

FIGURE 5.12. INVENTORY RATING VS. DEPTH OF FILL FOR MBC-5-34 5 9X8W0.

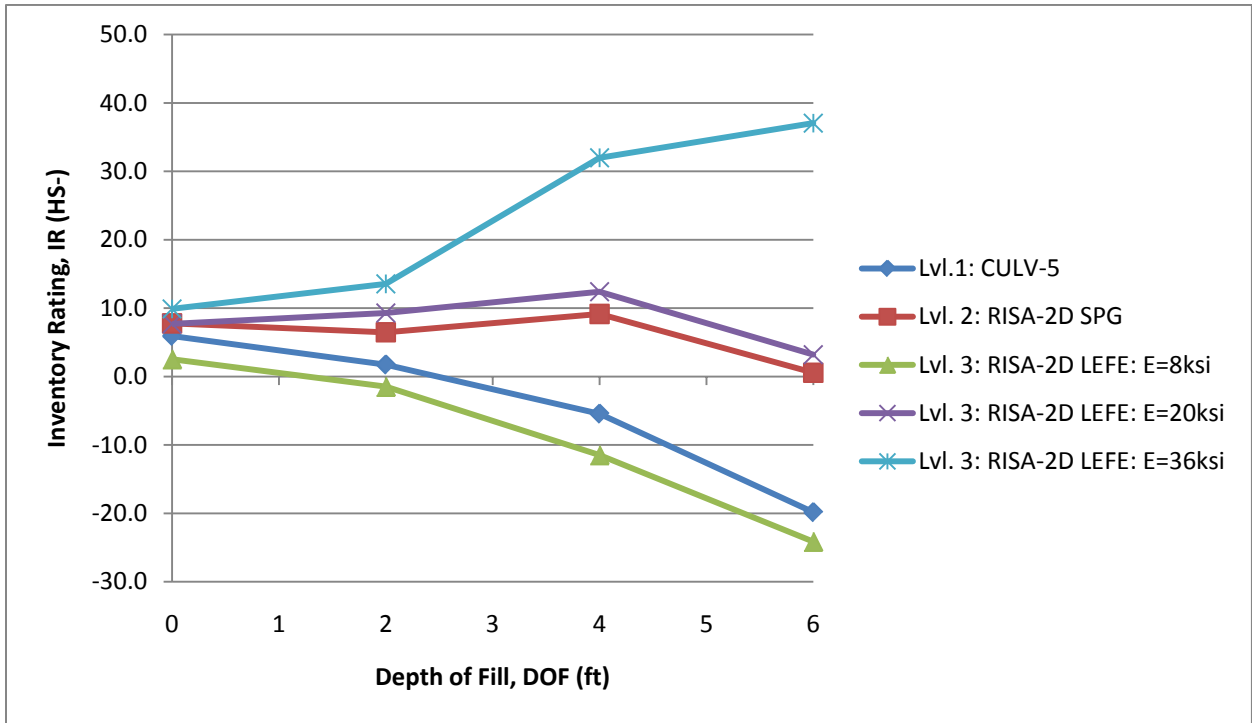
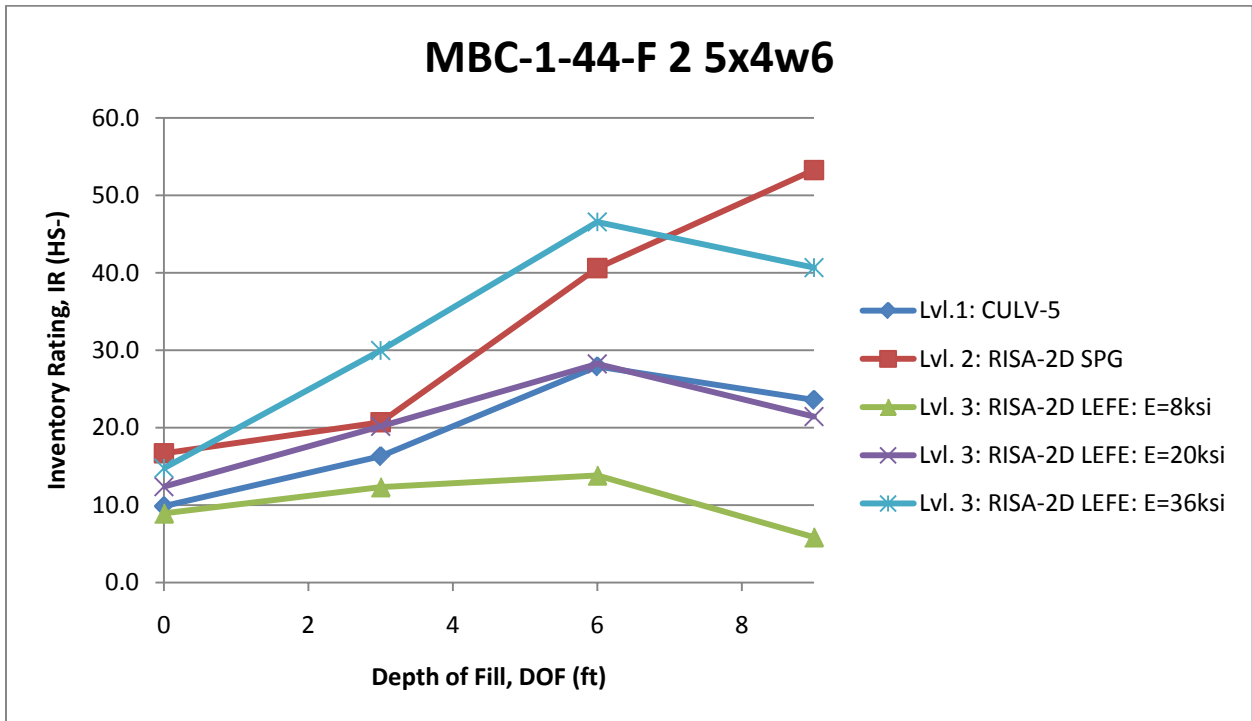

FIGURE 5.13. INVENTORY RATING VS. DEPTH OF FILL FOR MBC1-44-F 2 5X4W6.



### 3. *Conclusion*

The sensitivity of inventory rating to the depth of fill is very great and highly related to the structural design, particularly the maximum design fill depth. As expected, the load rating is heavily and non-linearly dependent upon depth of fill. As the fill depth increases, it becomes more important to identify the modulus of elasticity more precisely.

When designing culverts it is appropriate to calculate the load ratings for the maximum and minimum design fill depths, but intermediate fill depths may be ignored. When real culverts are rated, the rating should be calculated for the site-specific fill condition. If the soil properties reflect high quality backfill, it may be possible to exceed the maximum design fill depth, but soil properties must be validated.



#### 4. CONCLUSIONS

Table 5.15 summarizes results for the six variables analyzed in the parametric study. Four of the six variables – modulus of subgrade reaction, Poisson’s ratio, multibarrel effects, and lateral earth pressures – do not greatly influence the calculated inventory rating values.

TABLE 5.15. SUMMARY OF PARAMETRIC STUDY CONCLUSIONS.

VARIABLE	MODEL	SENSITIVITY OF INVENTORY RATING TO SELECTED PARAMETER
<i>Modulus of subgrade reaction, k</i>	2	Not sensitive; keep <i>Culvert Rating Guide</i> values
<i>Poisson's ratio, v</i>	3	Not sensitive; <i>Culvert Rating Guide</i> value of 0.3 is appropriate; 0.5 is more appropriate for deep fill clay soils
<i>Multibarrel effects</i>	3	Not sensitive; model 5+ barrels as 4 barrels for culv-5; model all barrels in higher order analyses
<i>Lateral earth pressures, lep</i> ( <i>equivalent fluid unit weight</i> )	1 & 2	Not sensitive; use AASHTO recommended value (60pcf)
<i>Modulus of elasticity, e</i>	3	Very sensitive; use factor of safety OR ±200 psi for high fill depths (more than 6ft) ±1000 psi for low fill depths (less than 6 ft)
<i>Depth of fill</i>	1, 2 & 3	Very sensitive; check at actual depth of fill for as-built culvert; check at maximum and minimum depth of fill for designs

Calculated inventory ratings are highly sensitive to the soil modulus of elasticity, which is the key parameter in the soil constitutive model for the Level 3 analysis (RISA 2D with LEFE). Given the complexity and variability of soil, it will be difficult to determine this parameter with the desired level of precision, and this will introduce uncertainty into the load rating process.

Calculated inventory ratings are also highly sensitive to the depth of fill above the culvert top slab. The effect is more pronounced for deep-fill culverts, compounding the sensitivity to soil modulus values. Culvert load rating analyses should model actual site conditions; whereas, culvert design should evaluate both maximum and minimum fill depths. A culvert’s capacity for overload fill depths will largely depend on the quality of the backfill.

Relative to validation of the *Culvert Rating Guide*, the findings from the parametric study are incorporated into the discussions for the respective parameters.



## 6. INSTRUMENTED LOAD TESTS ON THREE IN-SERVICE CULVERTS

### 1. OVERVIEW

#### 1. *Purpose and Scope*

This chapter presents findings from field instrumentation and load testing of three in-service reinforced concrete box culverts evaluated as part of this research study. The research team performed this work with the following objectives in mind:

- Obtain project-specific model input parameters for selected culverts.
- Measure actual strains and deflections under known load conditions to determine actual demand moments at critical sections for the culvert structure.
- Through site-specific geotechnical explorations, evaluate alternative methods for determining soil modulus values.
- Compare measured versus predicted demand moments to evaluate the reliability of the analytical modeling procedures presented in the *Culvert Rating Guide*.
- Further explore factors which influence production load rating of culverts.

This work continues the process of validation of the *Culvert Rating Guide* from *breadth* (load rating 100 culverts discussed in Chapter 4) to *sensitivity* (parametric analysis of 7 culverts discussed in Chapter 5) to an *in depth* study of the structural response of the culvert load-soil-structure system (presented herein).

#### 2. *Selection of Culverts for Instrumentation and Load Testing*

This project required that three in-service culverts be instrumented and load tested in the field. These three culverts were selected to be representative of the primary design eras of concern, namely 1946 era, the 1958 era with structural grade reinforcing, and the 1958 era with Grade 60 reinforcing. In addition to requiring three culverts from three different eras, the potential test culverts were evaluated for safety, ease of access, and distribution of other design parameters including depth of fill, box geometry, and number of spans.

The first test culvert is located 5 miles northwest of Shallowater, Texas. This culvert was built in 1963 making it an early 1958 era design (structural grade reinforcing). It consists of four 10' by 8' boxes. The location is a divided highway with a wide median; therefore, maneuvering room was available to perform load tests over two foot of fill and over four foot of fill.

The second test culvert is located in Plainview, Texas. This culvert was built in 1991 making it a late 1958 era design (Grade 60 reinforcing). It consists of four 10' by 6' boxes with 3.5 feet of fill and roadway over the culvert.

The third test culvert is located 8 miles east of Tulia Texas. This culvert was built in 1951 making it a 1946 transitional culvert design. It consists of five 6' by 6' barrels beneath 1.5 feet of fill and roadway.

## 2. LOAD TEST DESIGN

### 1. Load Rating Equation

The load test design for this study focuses on measuring and/or determining the three independent variables in load rating equation. These are the capacity, the dead load demand and the live load demand. Throughout this research, the capacity portion of the load rating equation has been assumed to be clearly defined per AASHTO policy and understood with a reasonable degree of precision. Apart from obtaining project-specific culvert parameters, capacity has not been specifically investigated in this task.

The dead and live load demands from the load rating equation, however, are determined through analytical modeling, and this research does investigate those terms. The field instrumentation plan and the load test procedure were designed to specifically measure and validate the live load moment demands relative to the culvert load rating process. This means that measuring live load demands is where most of the effort for this task was expended.

The initial research design restricted the load-testing portion of the study to consider only in-service culverts. One of the consequences of this *a priori* decision is that it places limitations on acquisition of dead load data. For in-service culverts, the initial stress condition of the as-built culvert is taken as a baseline for live load strain measurements. Those strains associated with placement of the culvert backfill, which amount to the dead load demand in the load rating equation, cannot be measured because the fill is already there. Notwithstanding this limitation, the research team did attempt to perform limited dead load measurements by placing overload fill at the Shallowater test site. Otherwise, the focus for the load test design was on measuring strains and deflections under known load conditions to calculate live load demands.

## 2. Measuring Live Load Demands – Instrumentation Design

Load ratings are determined for each critical section on the structure. Figure 6.1 shows the critical sections for a culvert without haunches. Two dimensional models are typically used to analyze culverts, therefore a unit width strip is typically considered. Because the load rating models consider a thin strip of the culvert and only analyze the demands at critical sections, the instrumentation plan was designed to consider a single cross section of the culvert at the critical sections. This was accomplished by establishing a gage line at a known location, normal to the culvert barrels, and placing various types of instrumentation along this gage line at or near the critical sections.

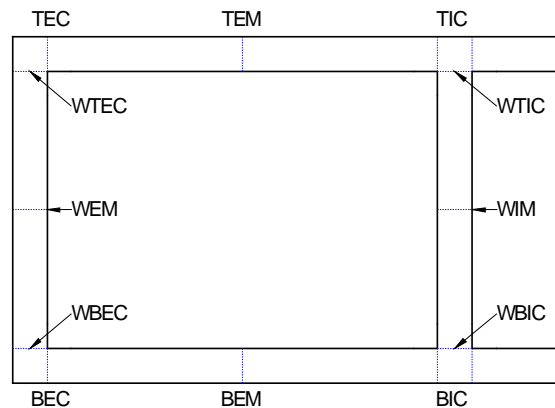

FIGURE 6.1. CRITICAL SECTIONS

The typical instrumentation plan consisted of placing strain gages at all interior critical sections for both corners and walls. Exterior critical sections were not readily accessible because the culvert is buried; however, critical sections along the top slab could typically be instrumented. In addition to the strain gages, the instrumentation plan included deflection measurements at midspans of the top and bottom slabs.

## 3. Application of Live Load – Field Test Procedure

The load test design was limited to in-service culverts in an effort to minimize field testing costs. The live load consisted of loaded TxDOT 10CY dump trucks. The live load procedure involved driving the loaded truck(s) across the top of the culvert, stopping the truck at two-foot increments along the pre-established gage line, and taking strain and deflection measurements at each stop. Once the truck(s) passed over the culvert, they were turned around and driven back over the culvert in the same manner but in the opposite direction, again stopping every 2 feet for a reading. Figure 6.1 shows a typical gage line used to establish the location of instrumentation as well as the dump truck's position above the culvert structure.



FIGURE 6.2. GAGE LINE CONSISTING OF TWO FOOT GRID MARKS TO DETERMINING TRUCK POSITIONS.

Three truck configurations were used for each load test. The first configuration consisted of a single truck driving over the culvert with the gage line between the wheels, *i.e.* straddling the gage line. The second configuration used a single truck driving over the culvert with one set of wheels directly on the gage line. The last configuration used two trucks driving over the culvert, in tandem, four feet apart with the gage line between them. Figure 6.3 shows the various truck positions over the gage line.



FIGURE 6.3. LIVE LOAD CONFIGURATIONS: A) TRUCK STRADDLING GAGE LINE B) WHEEL ON GAGE LINE C) 2 TRUCKS STRADDLING GAGE LINE.

The three truck configurations with the trucks traveling back and forth across the culvert were designed to facilitate creation of moment envelopes for the applied load combinations. The goal was to measure the worst case maximum and minimum moment demands for each critical section of the culvert structure.

#### 4. Predictive Analyses – Modeling the Load-Culvert-Soil System

The load test measured strains at the culvert critical sections; whereas, the load rating equation requires demand moments at each critical section. This means that the measured strains must be transformed into moment demands, and this is done through consideration of the strain profile in the culvert members (slabs and walls).

Curvature is calculated from strain. Where the strain is measured on both sides of the culvert slab or wall, the curvature is calculated directly using Equation 6.1.

**EQUATION 6.1. CURVATURE FROM INSIDE AND OUTSIDE STRAIN.**

$$\varphi = \frac{\varepsilon_I - \varepsilon_E}{h}$$

Where:  $\varphi$  = curvature  
 $\varepsilon_I$  = strain on the interior of the wall  
 $\varepsilon_E$  = strain on the exterior of the wall  
 $h$  = the wall thickness (in.)

Where the strain is only known on the inside face of the slab or wall, curvature is calculated assuming the centroid lies at the gross neutral axis according to Equation 6.2

**EQUATION 6.2. CURVATURE FROM INSIDE STRAIN.**

$$\varphi = \frac{2\varepsilon_I}{h}$$

Where:  $\varphi$  = curvature  
 $\varepsilon_I$  = strain on the interior of the wall  
 $h$  = the wall thickness (in.)

The cracked moment of inertia is established based on ACI approximations. For slabs, the cracked moment of inertia is 0.3 times the gross moment of inertia. For walls, the cracked moment of inertia is 0.5 times the gross moment of inertia. The measured moment is then calculated according to Equation 6.3.

**EQUATION 6.3. MEASURED MOMENT FROM STRAIN.**

$$M_m = \varphi E_c I$$

Where:  $M_m$  = the measured moment  
 $\varphi$  = curvature  
 $E_c$  = modulus of elasticity of concrete  
 $I$  = the moment of inertia of the wall

This process is consistent with standard mechanics of materials formulations and was used to convert the measured strains into demand moments at each critical section for each load test.

## 5. *Obtaining Test Parameters*

In addition to measuring live load demands, the field test procedure required acquisition of several other culvert parameters including dimensional data, structural strength data, soil parameters, and truck weights.

### 1. *Culvert dimensional data*

The number of barrels, span, height and wall thicknesses were determined from the culvert plan sheets and spot checked by field measurements for the actual culverts. Slab thicknesses and steel reinforcing schedules were determined from the plan sheets, and verified where practicable.

### 2. *Structural strength data*

The reinforcing steel yield strength was determined based on AASHTO *Manual for Condition Evaluation of Bridges (MCEB)* guidelines as per the culvert plan sheets. This research did not perform project-specific testing of the reinforcing steel.

The Level 2 and 3 analytical models used concrete compressive strengths determined by lab tests on concrete core specimens obtained from the bottom slab of the culverts. For the Level 1 model, the concrete compressive strength was assumed as per the *MCEB* values. The *MCEB* value was also used for the Level 2 model for comparison purposes. The modulus of elasticity of the concrete was calculated using the normal weight concrete relationship between compressive strength and modulus of elasticity.

### 3. *Soil parameters*

The soil unit weight was assumed as 120pcf according to guidance from the AASHTO *Standard Specifications for Highway Bridges (SSHB)*. This assumption was confirmed for reasonableness based on unit weight tests for undisturbed soil samples and nuclear density tests taken in the field. Soil strength data was determined from exploratory geotechnical borings, as described in the next section of this report.

### 4. *Truck weights*

The truck weights were measured independently by the TxDOT maintenance crews at local scales. Weights were measured for the whole truck, the front axle, and the rear tandem axle.



### **3. GEOTECHNICAL EXPLORATIONS AT THE CULVERT SITES**

#### ***1. Description***

The geotechnical exploration for this study consisted of drilling three geotechnical borings, approximately 15 feet deep, at each of the three culvert sites. TxDOT provided traffic control, and the boring locations were cleared for underground utilities (Dig-TESS) prior to drilling. The drill crew was required to follow TxDOT safety protocol while working within the TxDOT right-of-way including wearing reflective vests, hard hats, steel toe boots, etc.

#### ***2. Field Drilling and Sampling***

The test borings were drilled in the backfill zone of the culvert structures, two borings on one side and one boring on the other. Field drilling and sampling operations were designed to collect multiple sets of data from each boring including thin-walled tube samples (TWT), standard penetration tests (SPT), dynamic cone penetration (DCP) tests, pressuremeter tests (PMT), and Texas cone penetration (TCP) tests. Sampling and testing operations were performed in substantial accordance with applicable standard test methods. Appendix F presents the logs of borings for each culvert site.

#### ***3. Laboratory Testing***

The laboratory study consisted of performing tests on recovered samples to aid in identification and classification of soils and determination of soil properties. TxDOT personnel conducted these tests including Atterberg limits, minus-200 mesh sieve, sieve analysis, moisture content, unit weight, and unconfined compression. Tests were performed in substantial accordance with applicable TxDOT test methods. Data are summarized on the boring logs.

#### ***4. Falling Weight Deflectometer Testing***

In addition to the geotechnical sampling and testing, TxDOT conducted Falling Weight Deflectometer testing at each of the three culvert locations.

The falling weight deflectometer (FWD) is a trailer-mounted device that places an 11.8 inch (300 mm) diameter load plate in contact with the highway at each test location. A load column above the load plate carries a stack of weights that are dropped to impart a load to the pavement similar to that imparted by a passing dual truck tire set. A series of seven geophones spaced away from the load plate at 12 inch increments measures the surface deflection, generating a “deflection bowl.” (TxDOT, 2008) The testing interval was set at 30 locations per project, with data obtained for both approach and departure at each culvert.

FWD data including the raw deflection file, pavement layer thicknesses, layer Poisson ratios, probable layer moduli ranges, and asphalt temperatures at the time of testing are used to perform backcalculation of modulus values for the pavement subgrade. TxDOT currently uses version 6.0 of their MODULUS software for backcalculation of deflection data. Appendix G presents the backcalculated FWD modulus data for the each culvert.

## ***5. The Subsurface Profiles for Each Culvert Site***

The logs of borings (Appendix F) provide detailed information about subsurface conditions for each culvert site. These data were synthesized to create an idealized subsurface profile, and it is this idealized profile which is used for subsequent culvert modeling. Figure 6.4 summarizes the idealized profiles for each culvert site, along with a tabulation of field and laboratory soil strength tests.

Review of Figure 6.4 shows the following:

- Subsurface conditions for each project site can be idealized as two strata, Stratum I being from the top of ground to the base of the culvert, and Stratum II being below the base of the culvert.
- Culvert backfill soils are similar to the soils of the surrounding area. The culvert backfills explored for this study did not consist of “better material.”
- Significant variability exists in the raw soil data (SPT, TCP, DCP, UCS) for each stratum, with certain parameters easily varying more than an order of magnitude.
- Soil strength values used for analysis typically are the mean values with adjustments based on judgment.

The variability inherent in the raw soil data becomes significantly filtered in subsequent analyses. For example, SPT N-values for Stratum II of the Shallowater culvert range from 3 to 53 blows per foot, but subsequent analyses are based on a single value of 8 blows per foot. This means that geotechnical interpretations about basic soil strength properties do not carry forward the range of values, but the selected values do incorporate significant uncertainty.

## ***6. Determination of Modulus of Subgrade Reaction Parameters***

As has been noted, Level 2 analyses are based on the RISA-2D structural model and use soil springs for support of the culvert base. The stiffness of these springs is the modulus of subgrade reaction,  $k$ .

Figure 6.5 summarizes the idealized profiles for each culvert site, along with a tabulation of calculated modulus of subgrade reaction values for the lower soil stratum. Five methods were used to calculate the modulus of subgrade reaction values. These include:

- Table IV-2 of the *Culvert Rating Guide* (TxDOT, 2009)
- Portland Cement Association relationship chart (PCA, 1992)
- Figure 6, p. 7.1-219 from NAVFAC DM 7.1 (NAVFAC, 1986)
- Table 9.1, page 505 of *Foundation Analysis and Design* (Bowles, Foundation Analysis and Design, 1996)
- Equation 9.9, page 503, *Foundation Analysis and Design* (Bowles, Foundation Analysis and Design, 1996)

Figure 6.5 presents the modulus of subgrade reaction value for each method along with a brief statistical summary. Subgrade modulus values as determined by the different methods vary 200 to 350 percent. Recall that these calculations for modulus of subgrade reaction reflect idealized soil strength values, so this variation represents inherent scatter in the parameter, not variation in the soil. Of course, variation in the soil strength also exists.

### ***7. Determination of Soil Modulus Parameters***

Level 3 analyses are based on the RISA-2D structural model but use a linear-elastic constitutive model for the soil surrounding the culvert. The parameter that defines the stiffness of the linear-elastic soil model is the elastic modulus.

Figure 6.6 summarizes the idealized profiles for each culvert site, along with a tabulation of elastic modulus values determined for each soil stratum. Seven methods were used to calculate the elastic modulus values. These include:

- Tabular values from the *Culvert Rating Guide*
- Tabular values from McCarthy and Bowles texts (McCarthy D. F., 2007; Bowles, *Foundation Analysis and Design*, 1996)
- Derived values based on SPT data for sandy soils and UCS data for clayey soils (Bowles, *Foundation Analysis and Design*, 1996; Coduto, 2001)
- Correlated TCP data, related to SPT values (TxDOT, 2006)
- Correlated DCP data, related to SPT values (DGSI, 2005)
- Measured PMT data (Briaud J.-L. , 2005)
- Backcalculated values obtained from FWD data (TxDOT, 2008)

Review of Figure 6.6 shows the following:

- Elastic modulus values within a given stratum as determined by the different methods vary as much as 2500 percent or more. These calculations reflect idealized soil strength values, so this variation represents inherent scatter in the elastic modulus parameter, not variation in the soil. Of course, variation in the soil strength also exists.
- Tabulated elastic modulus values from the *Culvert Rating Guide* are typically at the high end.
- Falling weight deflectometer values are consistent and are typically second highest.
- Tabulated elastic modulus values from textbooks (beams on elastic foundations) are consistent and approximate the average of all values shown.

- Measured elastic modulus values based on the pressuremeter test are consistent and are the lowest values.
- Derived and correlated values based on field penetration tests yield the greatest variability.

As noted in Chapter 5, the inventory ratings for culverts are highly sensitive to the soil elastic modulus value. Therefore, rather than take an average of the different methods, this study determined the culvert load rating based on each of the different modulus values, the goal being to determine which method for determining soil modulus yields the most reliable results.

Culvert Site Location	Idealized Subsurface Profile	Raw Soil Data																			
		SPT N-values (blows/foot) uncorrected					TCP blowcounts (blows/foot)					DCP blowcounts (blows/1.75 inch)					UCS qu-values (tons per square foot)				
		min	max	mean	stdev	anal	min	max	mean	stdev	anal	min	max	mean	stdev	anal	min	max	mean	stdev	anal
Shallowater	0-10.5': Clayey Sand Fill (SC)	5	10	7.8	2.2	8	14	19	16.5	3.5	16	10	30	20.4	7.1	20					
	10.5'+: Clayey Sand (SC/SP)	3	53	28.0	35.4	8	11	11	11	na	16	7	12	10.0	2.6	20					
Plainview	0-10.5': Fat Clay Fill (CH)	5	14	9.8	4.0	10	13	18	15.5	3.5	16	4	27	12.7	10.2	15	2.7	7.6	4.7	2.2	4.0
	10.5'+: Silty/Clayey Sand (SP/SC)	16	27	21.5	7.8	20	99	99	99	na	100	6	25	17.3	10.0	23					
Tulia	0-7.5': Sandy Clay Fill (CL)	3	4	3.5	0.7	4	6	6	6	na	6	15	21	18.0	3.0	15	3.0	3.0	3.0	na	2.5
	7.5'+: Sand, clayey, silty (SP/SC)	8	29	17.8	9.5	18	13	101	57	62	60	7	30	14.4	9.1	16					

FIGURE 6.4. IDEALIZED SOIL PROFILE AND RAW FIELD AND LABORATORY SOIL STRENGTH DATA FOR THE THREE CULVERT SITES.

Culvert Site Location	Idealized Subsurface Profile	Modulus of Subgrade Reaction Values (all values shown in pounds per cubic inch (pci))										
		Culvert Rating Guide	PCA Chart	NAVFAC DM7.1	McCarthy Table 10.3	Bowles Table 9.1	Bowles Eq 9-9	min	max	mean	stdev	recm
		calc	calc	calc	calc	calc	calc					
Shallowater	0-10.5': Clayey Sand Fill (SC)											
	10.5'+: Clayey Sand (SC/SP)	150	200	87	87	77	74	74	200	113	51	150
Plairview	0-10.5': Fat Clay Fill (CH)											
	10.5'+: Silty/Clayey Sand (SP/SC)	150	250	150	130	242	117	117	250	173	58	150
Tulia	0-7.5': Sandy Clay Fill (CL)											
	7.5'+: Sand, clayey, silty (SP/SC)	150	250	87	87	186	72	72	250	139	70	150

FIGURE 6.5. IDEALIZED SOIL PROFILE AND DERIVED MODULUS OF SUBGRADE REACTION VALUES FOR THE THREE CULVERT SITES.

Culvert Site Location	Idealized Subsurface Profile	Recommended Soil Modulus Values for Analysis Purposes (all values shown in kips per square inch (KSI))																																		
		Culvert Rating Guide					Tabular Values (McCarthy, Bowles)					Derived Values (SPT-sand, UCS-clay)					Correlated Values (TCP-SPT)					Correlated Values (DCP-SPT)					Measured Values (PMT)					Backcalculated Values (FWD)				
		min	max	mean	stdev	recm	min	max	mean	stdev	recm	min	max	mean	stdev	recm	min	max	mean	stdev	recm	min	max	mean	stdev	recm	min	max	mean	stdev	recm	min	max	mean	stdev	recm
Shallowater	0-10.5': Clayey Sand Fill (SC)					<b>20</b>	1.4	11.7	5.9	4.1	<b>6</b>	1.0	7.0	2.6	2.3	<b>2</b>	1.0	7.0	2.6	2.3	<b>2</b>	1.3	7.6	3.3	2.4	<b>3</b>	0.92	1.17	1.0	0.2	<b>1.0</b>	10.8	13.1	12.0	0.9	<b>12</b>
	10.5'+: Clayey Sand (SC/SP)					<b>20</b>	1.4	11.7	5.9	4.1	<b>6</b>	1.0	7.0	2.6	2.3	<b>2</b>	1.0	7.0	2.6	2.3	<b>2</b>	1.3	7.6	3.3	2.4	<b>3</b>	0.89	1.96	1.4	0.8	<b>1.0</b>					
Plainview	0-10.5': Fat Clay Fill (CH)					<b>8</b>	1.0	14.5	6.4	6.0	<b>6</b>	3.3	49.4	23.0	18.5	<b>23</b>	21	28	24.5	4.9	<b>25</b>	9.2	32.2	19.2	9.9	<b>23</b>	0.60	1.14	0.9	0.4	<b>0.9</b>	7.1	8.1	7.6	0.7	<b>8</b>
	10.5'+: Silty/Clayey Sand (SP/SC)					<b>20</b>	6.9	11.8	9.4	2.7	<b>9</b>	1.6	8.5	4.9	2.9	<b>5</b>	4.5	19.9	9.2	6.0	<b>10</b>	1.3	7.8	3.4	2.4	<b>4</b>	0.60	0.94	0.8	0.2	<b>0.8</b>					
Tulla	0-7.5': Sandy Clay Fill (CL)					<b>8</b>	2.0	9.4	5.7	5.2	<b>6</b>	5.2	34.5	18.6	14.0	<b>18</b>	18	18	18	na	<b>18</b>	45	59	52.6	7.1	<b>54</b>	0.30	0.33	0.3	0.02	<b>0.3</b>	7.0	11.2	9.1	3.0	<b>9</b>
	7.5'+: Sand; clayey, silty (SP/SC)					<b>20</b>	12.1	14.7	13.4	1.8	<b>13</b>	1.5	8.5	4.6	2.7	<b>4</b>	2.1	12.0	6.1	3.8	<b>6</b>	1.2	7.5	3.1	2.2	<b>3</b>	1.48	2.33	1.9	0.6	<b>1.9</b>					

FIGURE 6.6. IDEALIZED SOIL PROFILE AND DERIVED ELASTIC MODULUS VALUES FOR THE THREE CULVERT SITES.



#### 4. THE SHALLOWATER CULVERT INSTRUMENTED LOAD TEST

##### 1. Culvert Condition

The Shallowater culvert is located in Lubbock County approximately 5 miles northwest of Shallowater, Texas. Figure 6.7 shows the location of the Shallowater test culvert. This culvert was built in 1963. The design is a Pre-1977 1958 era culvert designed under the THD Supplement No. 1. It consists of four 10' wide by 8' tall barrels. A three foot thick layer of silt had to be removed from inside this culvert before testing. The Shallowater culvert crosses US Highway 84, which is a divided four-lane road with a 45ft wide median. The culvert has 45° skew to the roadway. The culvert showed some distress with longitudinal cracking and efflorescence with rust. The culvert also suffered from very limited spalling.

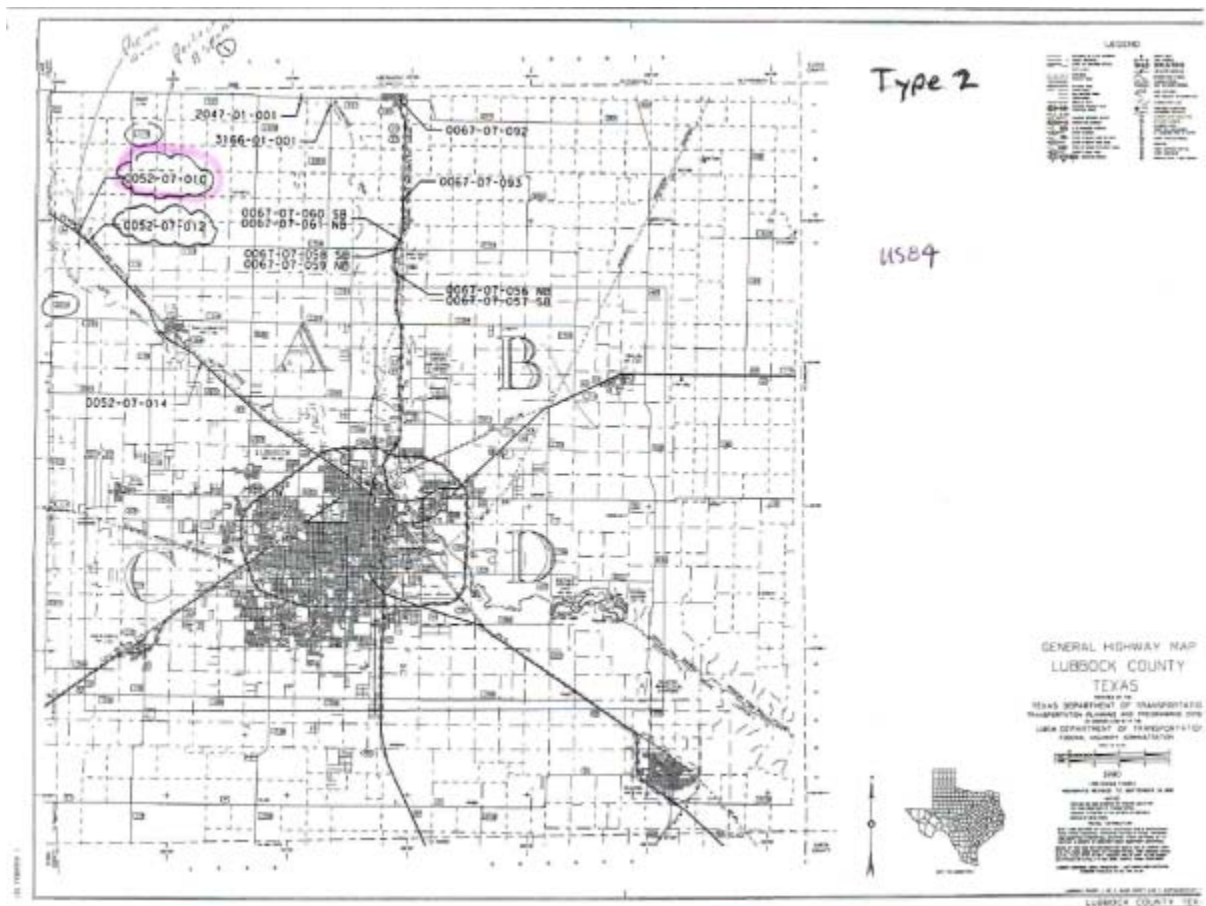

FIGURE 6.7. SHALLOWATER LOCATION.



## 2. *Summary of Parameters*

### 1. *Culvert Test Parameters*

Culvert dimensional data from the plan sheets showed 4 barrels, 10ft spans, 8ft height, 7.5in. thick top and bottom slabs, 8in. thick walls and 36ksi steel yield strength. According to the *MCEB*, 3ksi concrete was assumed for Level 1 and 2 analyses. For Level 2 and 3 analyses, the tested compressive strength of 6ksi from the concrete cores was used. The trucks weighed 54kips. The front single axles weighed 14kips, while the rear tandem axles weighed 40kips.

### 2. *Soil Test Parameters*

A soil unit weight of 120pcf was selected from the *Culvert Rating Guide*. A modulus of subgrade reaction,  $k$ , of 150pci from *Culvert Rating Guide* was used for Level 2 analysis. The modulus of elasticity for the soil,  $E_s$ ; was determined using seven different methods with values as follows:

1. 20 ksi from *Culvert Rating Guide*
2. 6 ksi from Bowles and McCarthy textbooks
3. 2 ksi from Standard Penetration Test (SPT)
4. 2 ksi from Texas Cone Penetration Test (TCP)
5. 3 ksi from Dynamic Cone Penetrometer (DCP)
6. 1 ksi from Pressuremeter (PMT)
7. 12 ksi from Falling Weight Deflectometer (FWD)

Testing was performed under two foot and four foot of fill.

### 3. Instrumentation Plan

The instrumentation plan involved placing 4in. electrical resistance strain gages at every critical section on the inside of the two westernmost barrels. Strain gages were also placed on the exterior of the top slab and at the top corner exterior walls opposite the corresponding interior gages. This allowed for direct measurement of changes in curvature in the strain profile. Linear displacement gages were placed at the centerline of the top and bottom slabs. Figure 6.8 shows the location of the strain gages (in purple) and the linear displacement gages (in blue).

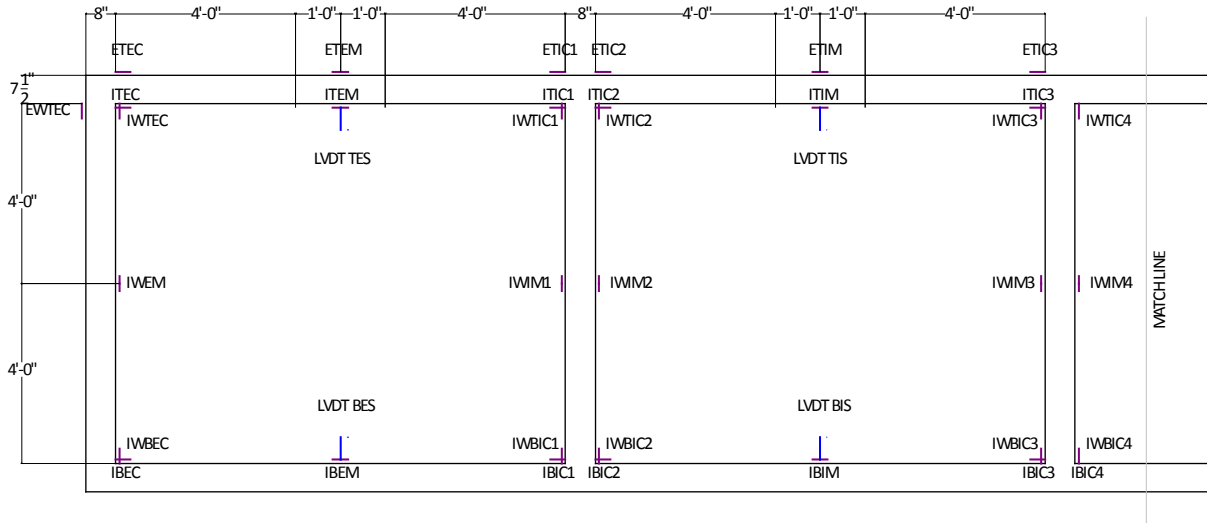

FIGURE 6.8. SHALLOWATER INSTRUMENTATION PLAN.

#### 4. Results for Shallowwater Culvert with 2' of Fill

##### 1. Load Rating

Figure 6.9 shows the normal load rating for the Shallowwater culvert under two feet of fill using all the different models and soil properties. Only four methods produced positive ratings and no methods produced a load rating, inventory or operating, above HS-20. The Level 2 analysis and the Level 3 analysis for both the *Culvert Rating Guide* and the falling weight deflectometer approaches show that the culvert should fail under live load. Level 1 and the other Level 3 analyses show that the culvert should fail under dead load.

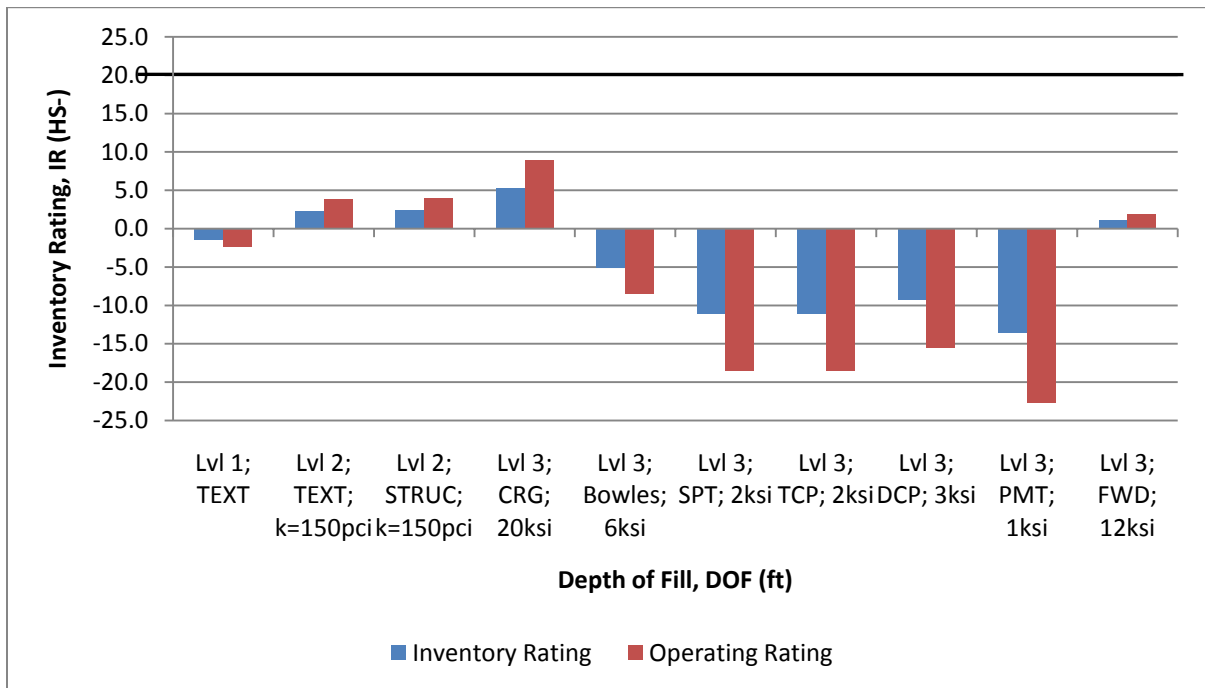

FIGURE 6.9. LOAD RATING FOR SHALLOWATER CULVERT: 2' OF FILL

Notwithstanding anticipated (poor) culvert performance as predicted by the load rating process, the Shallowwater culvert remains in service and clearly has *not* failed. Various explanations can be offered for this. First, the assumed structural material properties may be conservative. Second, it has already been noted that the soil around the culvert is a variable material and attempts to quantify soil strength relative to culvert support have produced a wide range of values. Third, the culvert rating calculation is sensitive to the constitutive model used for both the soil and the structure. The load ratings identified in Figure 6.9 reflect less-sophisticated constitutive models for both the reinforced concrete and the soil. And finally, environmental factors at this site are favorable, e.g., the site is typically dry and well-drained with low relative humidity. Taken together, these factors can account for the fact that the as-built culvert is serviceable, whereas the load rating prediction would suggest otherwise. The culvert has “stood the test of time.”

## 2. Live Load Moment – Predicted and Measured

Figure 6.10 shows the live load moment envelope for the Shallowater culvert beneath two feet of fill. The blue and red lines show the measured moment as well as error bars which show a reasonable range due to variations in concrete modulus, cracked moment of inertia and nature of four inch strain gages which measure average strain over the gage length and not the actual strain at the critical section. The measured moment is less than the predicted moment for all models.

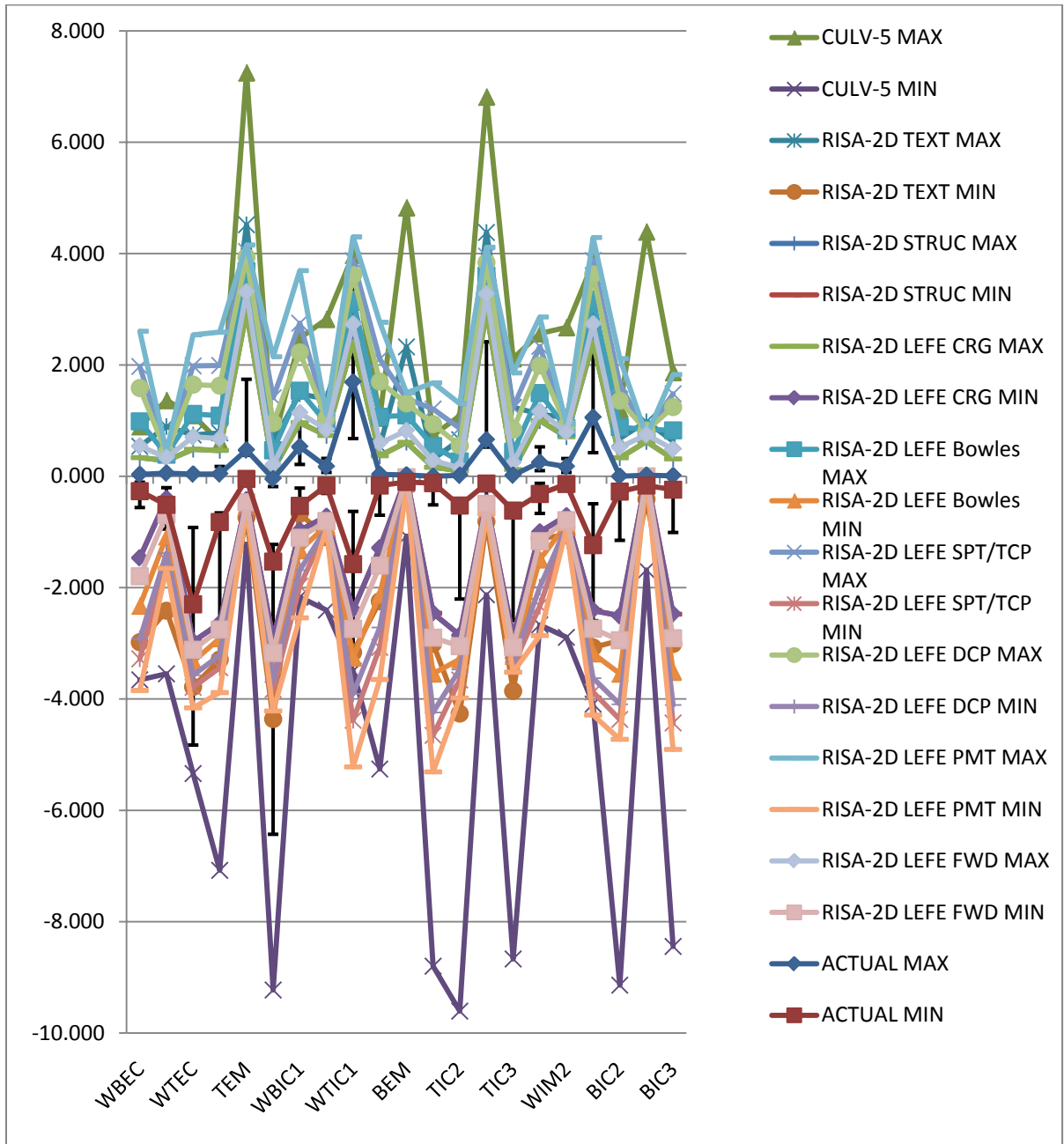

FIGURE 6.10. LIVE LOAD MOMENTS PREDICTED AND MEASURED FOR SHALLOWATER CULVERT: 2' OF FILL.

### 3. Dead Load Moment – Predicted

Figure 6.11 shows the predicted dead load distributions for the Shallowater culvert beneath two feet of fill for all models. The models predict similar directions for dead load effect, except for exterior corner locations.

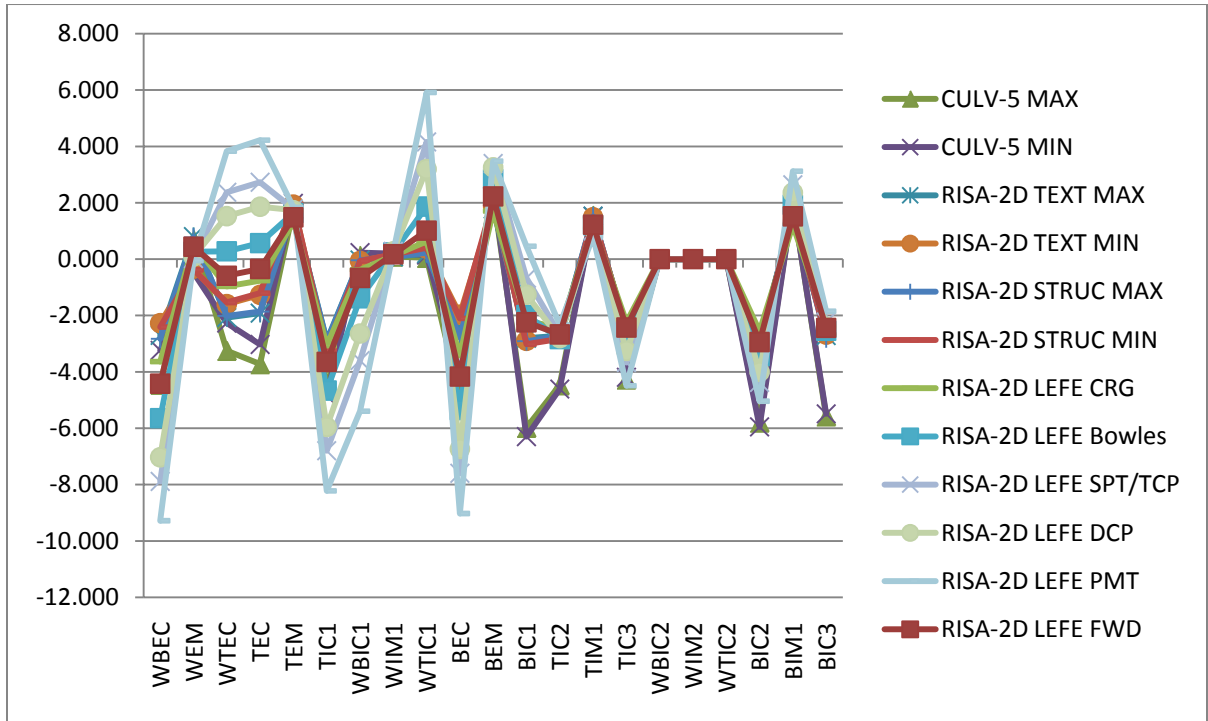

FIGURE 6.11. DEAD LOAD PREDICTED FOR SHALLOWATER CULVERT: 2' OF FILL.

#### 4. Live Load “Goodness”

In order to determine how well the model predicts live load (dead load cannot be measured on in-service culverts), the ratio of the predicted live load moment was compared to the actual live load moments. The ideal model would show a ratio of live load *predicted* to live load *actual* of 1.0. Excellent models would produce live load ratios only slightly greater than 1.0. Overly conservative models would produce live load ratios far greater than 1.0. Models which predict the appropriate direction but fail to predict significant magnitude would have a ratio of less than 1.0. A model which fails to even predict the appropriate direction would have a negative ratio. Table 6.1 shows the thresholds and color scheme used in the plots showing the goodness of the live load predictions.

From an economic view, critical sections which result in blue load ratings indicate a very safe but expensive model. Models which produce mostly green critical section ratios produce economical designs that maximize safety while minimizing cost. Yellow and red critical sections mean that the model makes unsafe predictions.

TABLE 6.1. LIVE LOAD PREDICTED TO ACTUAL RATIO THRESHOLDS

threshold	color	At that critical section, the model:
$10 < M_P/M_M$	dark blue	Is overly conservative.
$5 < M_P/M_M < 10$	blue	Is very conservative.
$2 < M_P/M_M < 5$	light green	Is conservative.
$1 < M_P/M_M < 2$	green	Is reasonably accurate.
$0 < M_P/M_M < 1$	yellow	Predicts the correct sign but an unconservative magnitude.
$M_P/M_M < 0$	red	Fails to predict the correct sign or magnitude.

Figure 6.12 shows the goodness plot for the Shallowater culvert beneath two feet of fill. The plot shows the number of critical sections which fall into each threshold. According to the plot, CULV-5 model produces the most conservative predictions. The least conservative model is the RISA-2D with LEFE using the *Culvert Rating Guide* and the Falling Weight Deflectometer soil moduli.

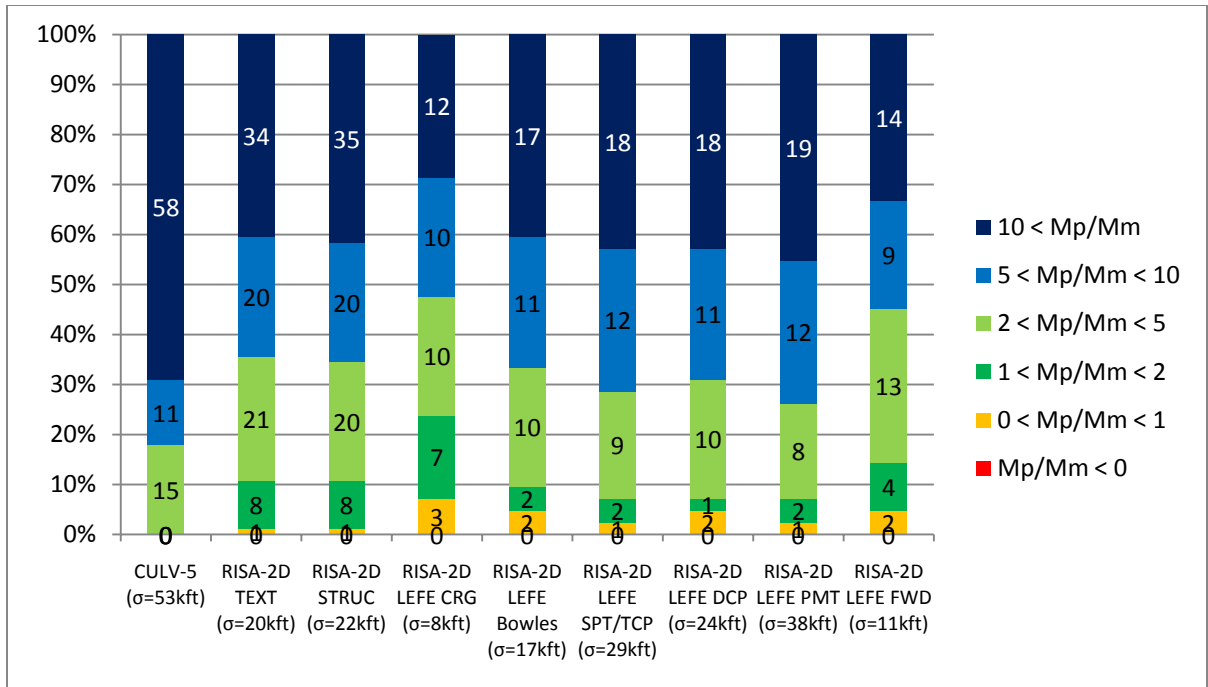

FIGURE 6.12. LIVE LOAD GOODNESS PLOT FOR SHALLOWATER CULVERT: 2' OF FILL

Also included in Figure 6.12 is the average standard deviation of the ratios for each of the models. The smaller the average standard deviation, the better the model fit. By this measure, CULV-5 is the least appropriate for accurately predicting the live load moments. RISA-2D with LEFE using the *Culvert Rating Guide* soil modulus values is the most appropriate model with the least amount of scatter and the most accurate prediction of the live load moment envelope shape.

### 5. Load Rating “Goodness”

Live load testing is a one-time load condition. Therefore, when evaluating the goodness of the load rating, the one-time load rating, or operating rating, was analyzed. The ratings calculated for the field test were determined using the field truck weights. Again the ideal model and design would produce a load rating of 1.0. Table 6.2 shows the thresholds and meaning of the various load ratings.

In this case, blue operating ratings means that the design as analyzed by that model at a given critical section is very adequate to carry the combined dead and live load at the cost of too stout a critical section. Green operating ratings indicate that the culvert was precisely adequate at that location to carry the dead load and truck weight. A yellow rating indicates that that critical section should have been broken under the truck load and the culvert was therefore unsafe under the truck load. A red rating indicated that that critical section should have failed under dead load alone and should not be standing under the dead load. Note that the color spectrum is the same for both Table 1.1 and Table 1.2, but these tables relate different concepts.

**TABLE 6.2. OPERATING RATING GOODNESS THRESHOLDS**

threshold	color	The critical section:
$10 < (C-1.3D)/2.17L$	dark blue	Has an overly high load rating.
$5 < (C-1.3D)/2.17L < 10$	blue	Has a very high load rating.
$2 < (C-1.3D)/2.17L < 5$	light green	Has an acceptably high load rating.
$1 < (C-1.3D)/2.17L < 2$	green	Has an optimized load rating.
$0 < (C-1.3D)/2.17L < 1$	yellow	Should fail under dead and live load.
$(C-1.3D)/2.17L < 0$	red	Should fail under dead load alone.

Figure 6.13 shows the number of critical sections in each threshold for each model. According to this plot, CULV-5 indicates that in at least one critical section the structure should be failed under dead load, and in almost 60% of the critical sections, the culvert should have failed under the truck load. RISA-2D with LEFE however shows that 50% of the culvert critical sections are well designed to handle the load and only 12% of the culvert critical sections should have failed under the truck load.



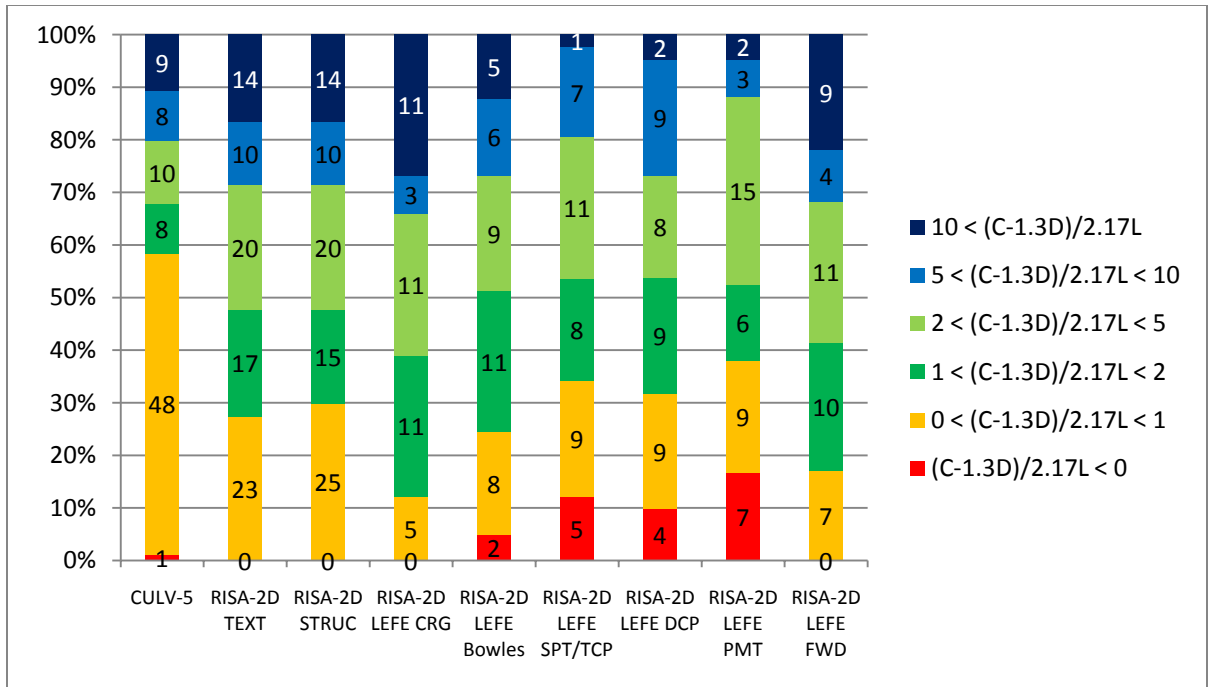

FIGURE 6.13. LOAD RATING GOODNESS PLOT FOR SHALLOWATER CULVERT: 2' OF FILL

## 6. Critical Section Analysis

It is important to note where the problem areas occur for the live load prediction and the operating rating. Problem sections for the live load predictions under-predict the live load moment. Problem sections for the load rating indicate that the in-service culvert should have failed under dead or live load. Qualitatively, the relationship between live load demand and load rating is inverse. This means that when the live load demand is low, the load rating will be high, and when the live load demand is high, the load rating will be low. Further, this means that the problem sections for the live load predictions, *i.e.* those sections where the live load demands are underestimated, will not produce the controlling, problematic, lowest load rating. In fact, the load rating should be controlled by the most conservative live load prediction.

To illustrate this point, the following tables show all the critical sections in every model for the Shallowater Culvert. Table 6.43 highlights the problem critical sections for the predicted live load demand. Table 6.4 shows the problem critical sections for the load rating. Careful examination of

Table 6.3 and Table 6.4 reveals that there is no overlap between the two sets of problem critical sections for the RISA-2D with spring models and most of the RISA-2D with LEFE models. Critical sections for live load are the same as critical sections predicted by the CULV-5 model at the wall top exterior corner WTEC and RISA-2D LEFE model with the pressuremeter soil values at the bottom interior midspan. These are the least accurate and most conservative models at non-critical sections.

**TABLE 6.3. LIVE LOAD DEMAND PROBLEM CRITICAL SECTIONS FOR SHALLOWATER CULVERT: 2' OF FILL**

	CULV-5				RISA-2D TEXT				RISA-2D STRUC				RISA-2D LEFE CRG		RISA-2D LEFE Bowles		RISA-2D LEFE SPT/TCP		RISA-2D LEFE DCP		RISA-2D LEFE PMT		RISA-2D LEFE FWD	
	TL		RLL		TL		RLL		TL		RLL		max	min	max	min	max	min	max	min	max	min	max	min
	max	min	max	min	max	min	max	min	max	min	max	min	max	min	max	min	max	min	max	min	max	min	max	min
WBEC	6.9	13.7	26.8	11.2	8.6	11.1	16.1	10.1	9.3	12.3	16.7	11.2	10.0	5.5	29.5	8.7	59.0	12.2	47.4	10.9	77.8	14.4	16.2	6.7
WEM	24.5	5.5	11.8	6.9	16.0	3.4	3.5	4.7	15.9	3.5	3.3	4.9	5.1	0.8	6.9	2.1	7.7	2.9	7.5	2.7	7.9	3.2	6.0	1.3
WTEC	11.1	2.3	28.1	2.0	12.4	1.6	19.0	1.5	14.5	1.6	21.1	1.5	12.4	1.3	28.7	1.4	50.8	1.6	42.2	1.6	65.0	1.8	18.1	1.4
TEC	4.0	8.6	14.6	8.1	9.2	4.0	18.6	3.5	11.2	4.0	20.6	3.5	11.1	3.2	26.1	3.5	47.6	4.2	38.9	3.9	61.9	4.7	16.3	3.3
TEM	15.1	26.1	15.4	23.3	9.3	15.9	9.6	13.2	9.4	15.8	9.6	13.1	6.3	9.0	7.8	10.9	8.6	11.9	8.4	11.6	8.8	12.2	7.0	10.0
TIC1	-13.0	5.9	-9.0	6.0	-14.0	2.8	-10.3	2.8	-14.8	2.8	-11.2	2.9	-2.7	1.9	-10.5	2.2	-31.9	2.5	-21.6	2.4	-48.6	2.8	-4.7	2.1
WBIC1	4.6	4.1	4.7	4.0	2.8	1.2	2.8	1.3	2.8	1.1	2.9	1.1	1.8	1.8	2.9	2.5	5.2	3.7	4.2	3.2	7.0	4.8	2.2	2.1
WIM1	15.9	14.4	16.3	14.0	7.7	6.6	8.0	6.3	8.0	6.6	8.3	6.3	4.2	4.3	5.5	5.3	6.2	5.6	6.0	5.6	6.4	5.6	4.8	4.8
WTIC1	2.3	2.2	2.3	2.2	1.7	2.0	1.7	2.0	1.6	2.0	1.7	2.0	1.4	1.5	1.9	2.1	2.3	2.8	2.1	2.5	2.5	3.3	1.6	1.7
BEC	17.6	31.6	30.6	28.9	4.5	13.5	15.7	11.0	5.4	15.3	16.4	12.9	10.7	7.7	31.2	12.7	61.3	18.5	49.6	16.3	80.7	21.9	17.4	9.6
BEM	192.0	10.5	197.4	9.2	92.5	1.8	95.0	0.7	104.2	1.9	107.3	0.7	25.0	0.1	44.7	0.5	57.2	1.3	53.5	1.0	61.3	2.0	33.5	0.2
BIC1		70.3		71.8	23.9		24.5		25.9		26.5		20.1		28.9		38.0		34.6		43.3		23.7	
TIC2	63.3	18.1	58.1	18.3	38.2	8.0	33.8	8.1	42.7	8.1	38.4	8.3	5.9	5.4	15.5	6.3	50.2	7.0	32.2	6.6	75.9	7.6	9.1	5.8
TIM1	10.4	16.2	10.4	16.4	6.7	6.1	6.7	6.3	6.7	6.1	6.7	6.3	4.5	3.6	5.5	4.2	6.0	4.8	5.9	4.6	6.3	5.2	5.0	3.8
TIC3	105.3	14.1	107.8	14.0	60.9	6.3	63.1	6.2	64.8	6.2	67.0	6.2	6.3	4.7	22.3	5.2	62.6	5.5	42.7	5.4	94.5	5.7	12.2	5.0
WBIC2	10.2	8.4	10.2	8.4	4.4	3.5	4.4	3.5	4.5	3.6	4.4	3.5	4.0	3.1	5.9	4.7	9.3	7.3	7.9	6.3	11.4	9.0	4.6	3.7
WIM2	15.5	20.7	15.5	20.7	6.1	7.5	6.1	7.5	6.1	7.5	6.1	7.6	4.1	5.1	5.0	6.2	5.3	6.6	5.3	6.5	5.5	6.7	4.6	5.7
WTIC2	3.6	3.3	3.6	3.3	2.9	2.5	2.9	2.5	2.9	2.5	2.9	2.5	2.3	2.0	3.0	2.6	3.7	3.1	3.4	2.9	4.1	3.5	2.6	2.2
BIC2		33.0		33.3	10.5		10.8		11.4		11.6		9.1		12.9		15.9		14.9		17.2		10.7	
BIM1	223.9	10.0	222.9	10.1	49.7	2.4	50.1	2.5	53.2	2.6	53.4	2.7	31.8	0.0	43.0	0.0	38.8	0.0	41.7	0.0	36.8	0.1	38.1	0.0
BIC3	185.4	35.1	190.4	34.9	60.7	12.5	64.2	12.4	61.7	13.3	65.2	13.3	31.8	10.3	84.1	14.6	151.0	18.4	126.7	17.1	186.2	20.4	49.3	12.1

**TABLE 6.4. OPERATING RATING PROBLEM CRITICAL SECTIONS FOR SHALLOWATER CULVERT: 2' OF FILL**

	CULV-5				RISA-2D TEXT				RISA-2D STRUC				RISA-2D LEFE CRG		RISA-2D LEFE Bowles		RISA-2D LEFE SPT/TCP		RISA-2D LEFE DCP		RISA-2D LEFE PMT		RISA-2D LEFE FWD	
	TL		RLL		TL		RLL		TL		RLL		max	min	max	min	max	min	max	min	max	min	max	min
	max	min	max	min	max	min	max	min	max	min	max	min	max	min	max	min	max	min	max	min	max	min	max	min
WBEC	26.12	0.05	5.41	0.47	14.94	0.65	7.21	0.88	14.35	0.65	7.22	0.88	15.65	0.75	7.36	-0.39	4.82	-0.96	5.46	-0.79	4.19	-1.18	11.12	0.18
WEM	0.67	1.88	3.19	1.17	0.91	3.16	9.84	1.78	0.97	3.16	10.75	1.78	3.90	13.17	3.50	4.64	3.74	3.15	3.67	3.50	3.80	2.83	3.51	7.49
WTEC	11.22	0.26	3.54	0.51	7.62	0.68	4.32	0.86	6.44	0.68	3.83	0.86	5.35	1.27	1.20	1.51	-0.38	1.88	0.06	1.75	-0.87	2.06	3.13	1.33
TEC	41.47	0.07	10.17	0.18	13.34	0.71	5.73	1.02	10.88	0.71	5.14	1.02	8.61	1.35	2.45	1.69	0.25	2.05	0.84	1.93	-0.38	2.20	5.27	1.45
TEM	0.20	3.21	0.17	3.79	0.33	5.22	0.28	6.61	0.34	5.22	0.29	6.61	0.64	10.37	0.43	9.14	0.36	8.65	0.38	8.79	0.34	8.50	0.53	9.66
TIC1	13.50	0.24	20.26	0.21	9.86	0.92	13.91	0.83	9.45	0.92	12.96	0.83	52.93	1.36	16.95	0.70	7.11	0.06	9.61	0.29	5.34	-0.28	33.09	1.06
WBIC1	0.94	1.16	0.87	1.25	1.65	3.59	1.66	3.47	1.64	3.59	1.64	3.47	2.91	2.10	2.48	0.78	2.19	-0.60	2.27	-0.13	2.12	-1.17	2.71	1.59
WIM1	0.83	1.04	0.78	1.11	1.73	2.27	1.62	2.43	1.68	2.27	1.57	2.43	3.14	3.54	2.29	3.01	2.00	2.89	2.06	2.91	1.95	2.88	2.69	3.23
WTIC1	0.60	0.70	0.57	0.74	0.78	0.82	0.70	0.90	0.79	0.82	0.71	0.90	0.74	1.27	0.18	1.32	-0.45	1.50	-0.21	1.44	-0.81	1.60	0.52	1.25
BEC	15.05	-0.12	7.92	0.03	44.77	0.70	11.50	1.25	38.11	0.70	11.34	1.25	20.95	0.72	9.03	-0.48	5.65	-1.06	6.49	-0.88	4.82	-1.29	14.17	0.10
BEM	0.41	4.11	0.35	4.94	1.08	21.49	1.00	53.56	0.93	21.49	0.85	53.56	4.23	524.94	1.33	122.09	0.65	47.47	0.79	64.01	0.55	32.15	2.52	308.44
BIC1	13.86	0.08	18.94	0.04	22.89	1.31	38.88	1.25	23.95	1.31	41.30	1.25	39.88	1.92	11.54	1.38	4.11	1.34	5.94	1.33	2.29	1.38	23.41	1.60
TIC2	7.05	0.24	7.82	0.23	8.99	0.97	10.36	0.93	8.12	0.97	9.19	0.93	56.46	1.60	22.74	1.27	6.86	1.19	10.91	1.22	4.27	1.18	37.86	1.43
TIM1	0.24	1.75	0.25	1.72	0.38	4.59	0.39	4.43	0.39	4.59	0.40	4.43	0.70	9.01	0.56	7.82	0.56	6.47	0.56	6.94	0.59	5.65	0.61	8.51
TIC3	3.61	0.29	3.49	0.30	4.77	1.10	4.58	1.12	4.52	1.10	4.35	1.12	44.49	1.66	13.61	1.33	5.61	0.98	7.74	1.13	4.16	0.72	23.58	1.50
WBIC2	0.94	0.90	0.94	0.90	2.15	2.15	2.18	2.18	2.13	2.15	2.20	2.18	2.42	2.42	1.62	1.62	1.04	1.04	1.22	1.22	0.85	0.85	2.08	2.08
WIM2	0.90	0.83	0.90	0.83	2.29	2.29	2.28	2.28	2.31	2.29	2.29	2.28	3.41	3.41	2.80	2.80	2.63	2.63	2.67	2.67	2.58	2.58	3.07	3.07
WTIC2	0.63	0.59	0.63	0.59	0.78	0.78	0.79	0.79	0.78	0.78	0.79	0.79	1.01	1.01	0.76	0.76	0.63	0.63	0.67	0.67	0.56	0.56	0.89	0.89
BIC2	8.33	0.09	9.15	0.08	10.42	1.31	12.00	1.24	10.40	1.31	11.94	1.24	20.60	1.73	8.76	0.97	5.25	0.58	6.11	0.70	4.41	0.39	13.91	1.34
BIM1	0.50	2.50	0.51	2.45	2.75	9.22	2.72	8.97	2.54	9.22	2.52	8.97	4.95	NA	2.80	NA	2.17	NA	2.36	NA	1.63	587.61	3.71	NA
BIC3	5.38	0.13	5.19	0.14	11.63	1.31	10.95	1.33	11.73	1.31	11.04	1.33	20.95	1.88	8.28	1.24	4.40	1.05	5.39	1.09	3.36	1.03	13.92	1.53

The meaningful conclusion from this analysis is that CULV-5 should be used for *design* purposes. In general, the CULV-5 model overestimates the demands and produces safe structures. However, for *load rating*, a much less conservative model, even an unconservative model, is desirable, because it will reduce over-conservatism in the controlling critical sections without actually introducing unconservatism into the load rating.

### 7. Deflections

Deflection data were collected as a backup measure. Because the strain data provided such consistent and accurate results, only a cursory look was given at the measured deflections under live load. Figure 6.14 shows the measured deflection in the culvert at the midspans. In the top spans the maximum deflection inward (positive) was between 0.84 and 0.64 millimeters. Some very slight outward deflection (negative) was also recorded. Deflections in the bottom slabs were essentially negligible.

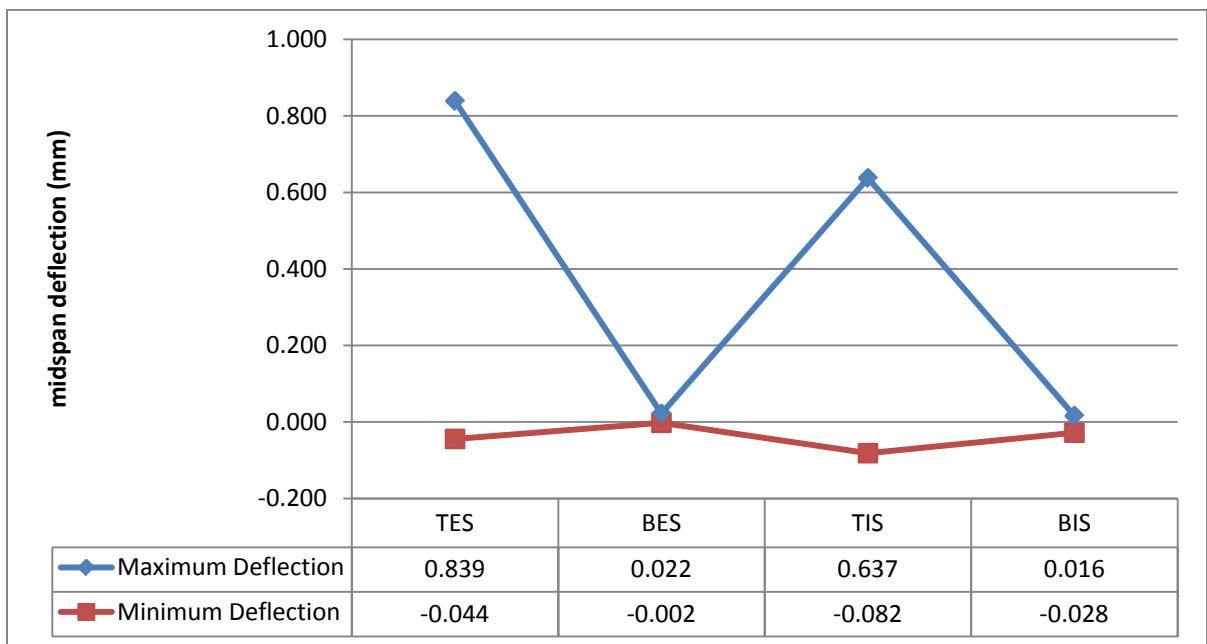

FIGURE 6.14. MEASURED DEFLECTIONS IN MILLIMETERS FOR THE SHALLOWATER CULVERT: 2' OF FILL

### 8. *Summary of Findings for the Shallowater Culvert with 2' of Fill*

From this case study the following findings are noted:

1. Predicted sign for live load moment corresponds to actual moment sign indicating excellent agreement between reality and the models.
2. Predicted magnitude for live load moment typically higher than actual moment magnitude and therefore conservative.
3. Scatter for predicted dead load moment is higher than for predicted live load moment (stdev = 0.98/0.56).
4. Critical sections for live load are not the same as critical sections for the Operating Rating.
5. CULV-5 yields most conservative moments and among the worst Operating Rating.
6. RISA-LEFE (Es per Culvert Rating Guide) yields least conservative moments and highest Operating Rating.

## 5. Results for Shallowater Culvert with 4' of Fill

### 1. Load Rating

Figure 6.15 shows the normal load rating for the Shallowater culvert under four feet of fill using all the different models and soil properties. Only one method produced positive ratings and no method produced a load rating, inventory or operating, above HS-20. The Level 3 analysis using the *Culvert Rating Guide* soil modulus shows that the culvert should fail under the slightest live load. All other models show that the culvert should fail under four feet of fill.

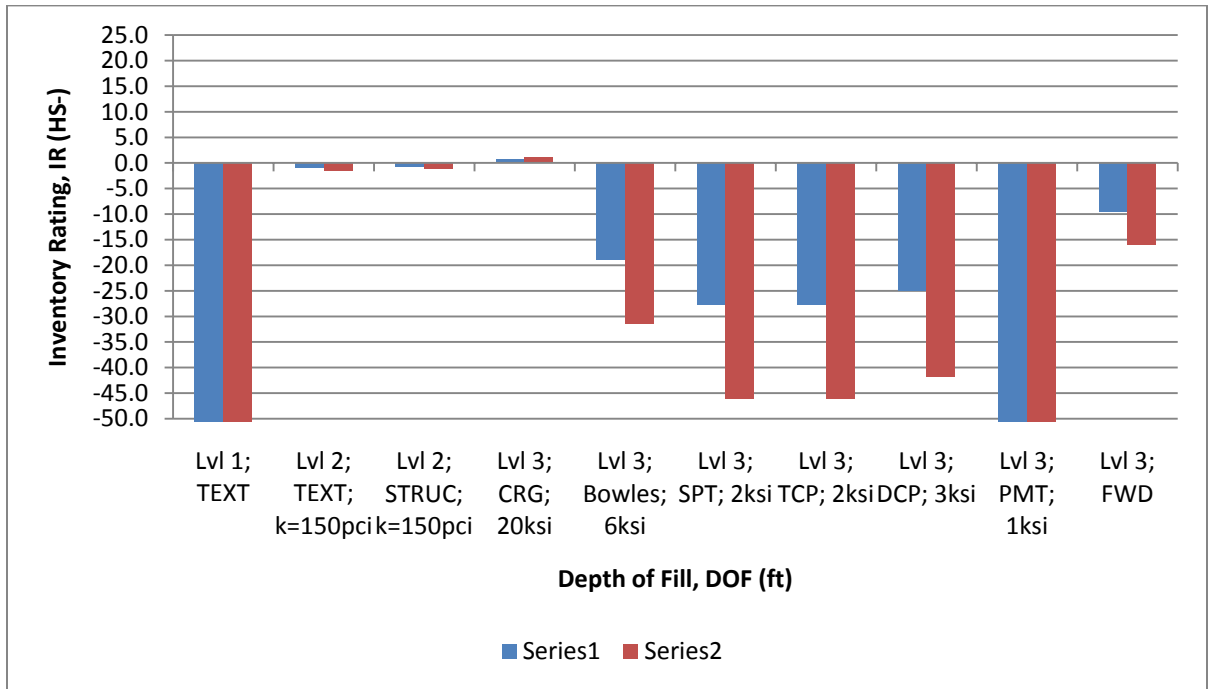

FIGURE 6.15. LOAD RATING FOR SHALLOWATER CULVERT: 4' OF FILL

As already noted, the Shallowater culvert remains in service and clearly has *not* failed, this despite the fact that the load rating process would predict otherwise. Favorable environmental conditions, conservative structural properties, soil properties, and constitutive models for both the reinforced concrete and the soil can reasonably explain why this culvert has “stood the test of time.”

## 2. Live Load Moment – Predicted and Measured

Figure 6.16 shows the live load moment envelope for the Shallowater culvert beneath four feet of fill. The blue and red lines show the measured moment. The error bars show a reasonable range due to variations in concrete modulus, cracked moment of inertia, and the nature of four inch strain gages which measure average strain over the gage length and not the actual strain at the critical section. The measured moment is less than the predicted moment for all models.

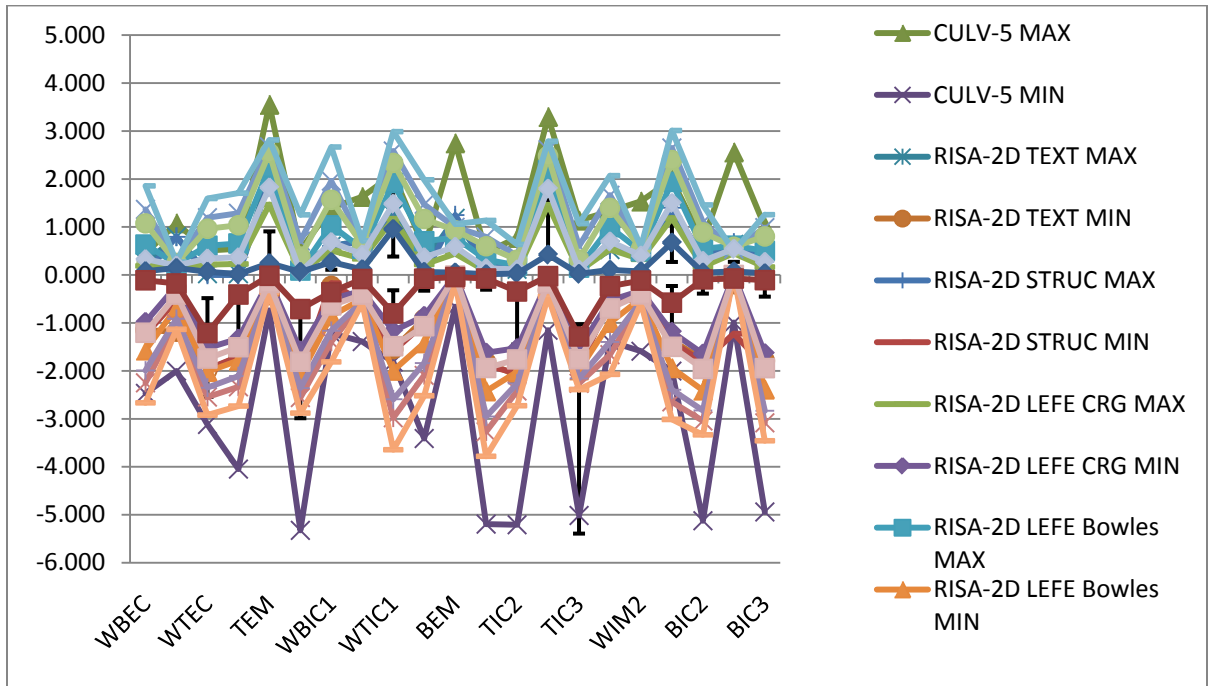

FIGURE 6.16. LIVE LOAD MOMENTS PREDICTED AND MEASURED FOR SHALLOWATER CULVERT: 4' OF FILL.

### 3. Dead Load Moment – Predicted

Figure 6.17 shows the predicted dead load distributions for the Shallowater culvert beneath four feet of fill for all models. The models predict similar directions for dead load effect, except for exterior corner locations.

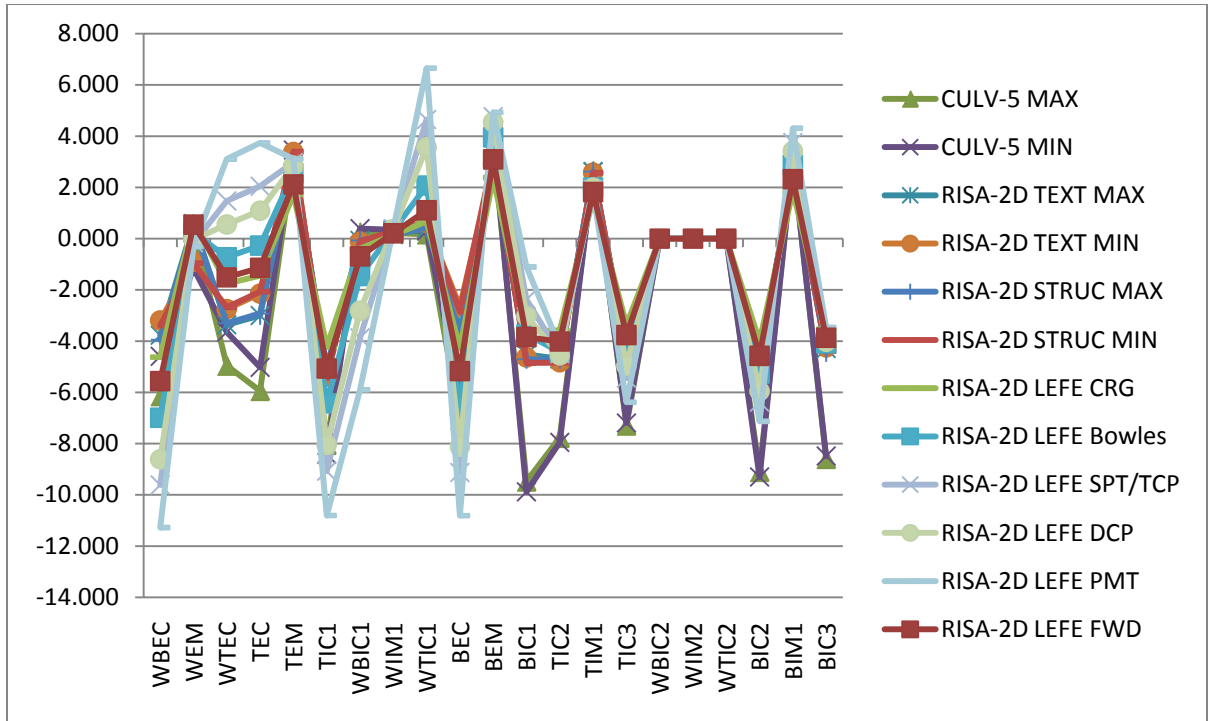

FIGURE 6.17. DEAD LOAD PREDICTED FOR SHALLOWATER CULVERT: 4' OF FILL.



#### 4. Live Load “Goodness”

Figure 6.18 shows the goodness plot for the Shallowater culvert beneath four feet of fill. The plot shows the number of critical sections which fall into each threshold. According to the plot, the CULV-5 model produces the most conservative predictions. The least conservative model is the RISA-2D with LEFE using the *Culvert Rating Guide* soil modulus.

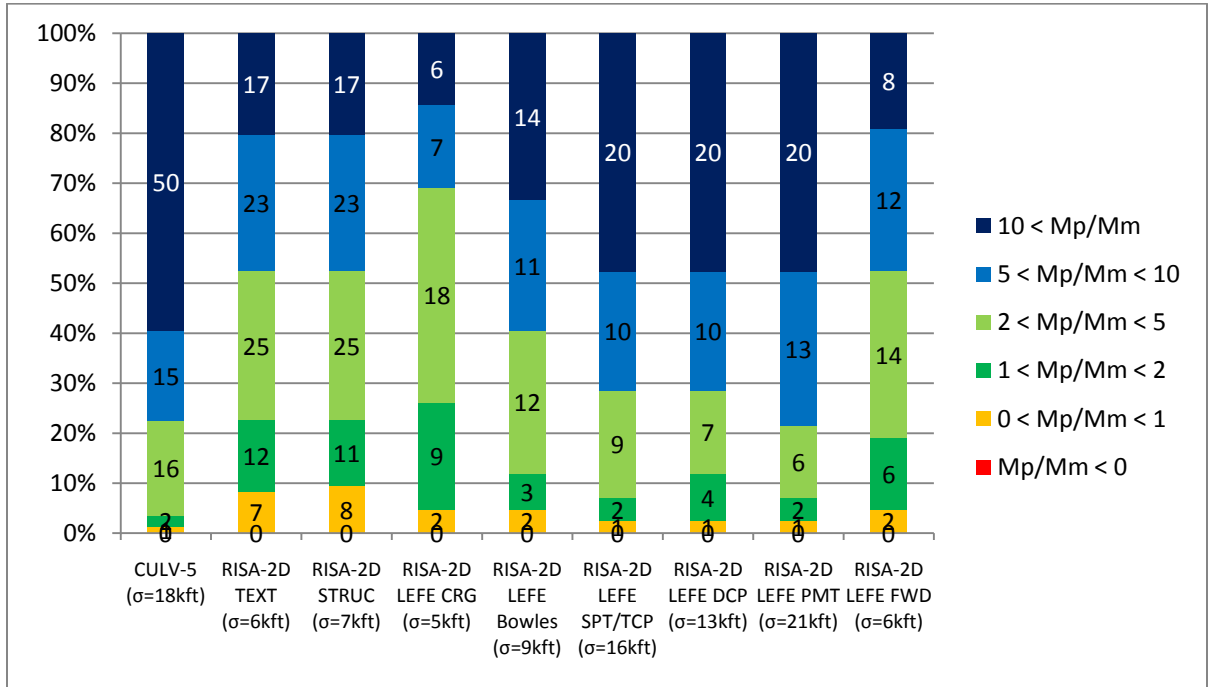

FIGURE 6.18. LIVE LOAD GOODNESS PLOT FOR SHALLOWATER CULVERT: 4' OF FILL

Also included in Figure 6.18 is the average standard deviation of the ratios for each of the models. The smaller the average standard deviation, the better the model fit. By this measure, CULV-5 and RISA-2D with LEFE using the pressurimeter (PMT) soil modulus are the least appropriate for accurately predicting the live load moments. RISA-2D with LEFE using the *Culvert Rating Guide* soil modulus values is the most appropriate model with the least amount of scatter and the most accurate prediction of the live load moment envelope shape.

### 5. Load Rating “Goodness”

Figure 6.19 shows the number of critical sections in each threshold for each model. According to this plot, CULV-5 indicates that 25% of the critical sections in the structure should fail under dead load, and in 10% of the critical sections, the culvert should have failed under the truck load. RISA-2D with LEFE using the *Culvert Rating Guide* however shows that nearly 50% of the culvert is well designed to handle the load and only two critical sections should have failed under the trucks.

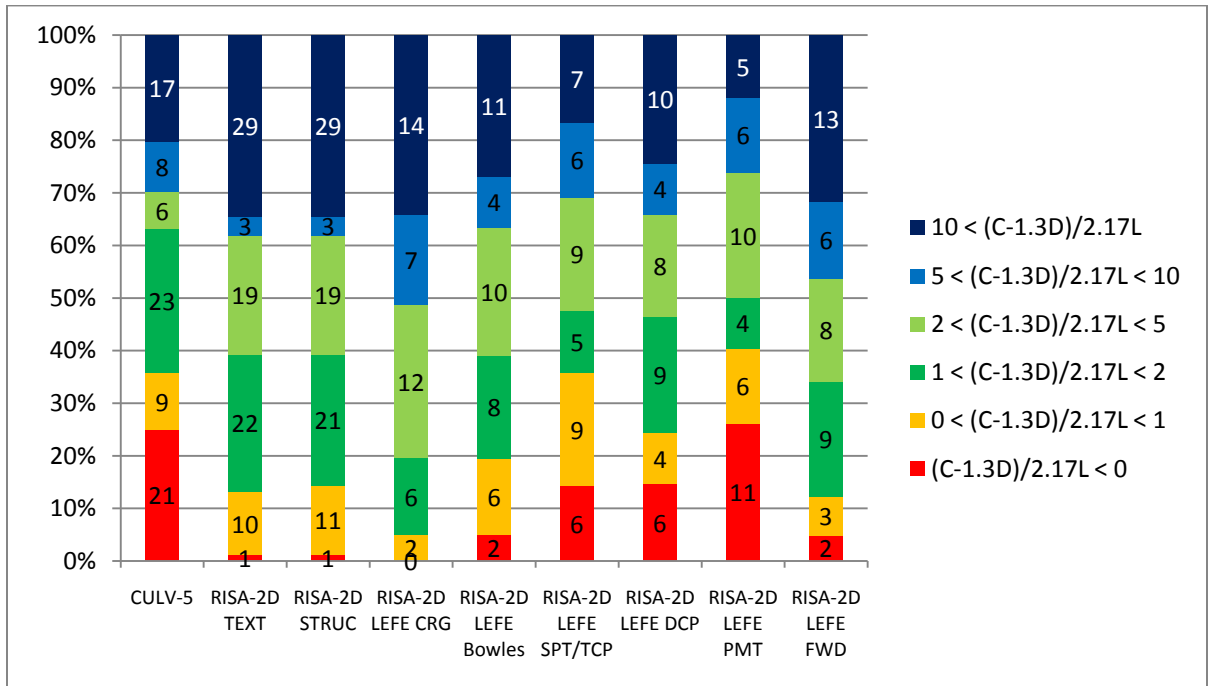

FIGURE 6.19. LOAD RATING GOODNESS PLOT FOR SHALLOWATER CULVERT: 4' OF FILL

### 6. Critical Section Analysis

The load rating should be controlled by the most conservative live load prediction. The following tables show all the critical sections in every model. highlights the problem critical section for the predicted live load demand. Table 6.6 shows the problem critical section for the load rating. Careful inspection of Table 6.5 and Table 6.6 reveals that there is no overlap between the two sets of problem critical sections.

TABLE 6.5. LIVE LOAD DEMAND PROBLEM CRITICAL SECTIONS FOR SHALLOWATER CULVERT: 4' OF FILL

	CULV-5				RISA-2D TEXT				RISA-2D STRUC				RISA-2D LEFE CRG		RISA-2D LEFE Bowles		RISA-2D LEFE SPT/TCP		RISA-2D LEFE DCP		RISA-2D LEFE PMT		RISA-2D LEFE FWD	
	TL		RLL		TL		RLL		TL		RLL		max	min	max	min	max	min	max	min	max	min	max	min
	max	min	max	min	max	min	max	min	max	min	max	min	max	min	max	min	max	min	max	min	max	min	max	min
WBEC	1.9	22.1	5.8	16.2	0.2	10.3	3.3	7.7	0.4	11.1	3.5	8.6	2.4	8.8	8.1	14.1	17.5	20.2	13.8	17.8	23.8	23.9	4.2	10.8
WEM	7.4	7.3	2.6	11.2	5.5	2.8	0.7	6.6	5.5	3.0	0.7	6.9	1.1	1.2	1.6	3.8	1.8	5.7	1.7	5.1	1.9	6.3	1.4	2.3
WTEC	0.1	2.6	7.6	2.0	0.2	1.6	0.4	1.4	0.2	1.6	0.4	1.4	3.2	1.3	9.1	1.7	17.8	2.1	14.4	1.9	23.8	2.4	5.1	1.4
TEC	5.9	9.9	31.7	8.8	0.9	4.2	1.5	3.3	0.9	4.2	1.5	3.2	13.3	3.3	38.0	4.4	74.6	5.7	60.2	5.2	99.0	6.7	21.4	3.7
TEM	13.9	43.0	14.5	35.3	8.0	24.3	8.5	16.9	8.0	24.5	8.5	17.0	6.0	6.7	9.1	14.1	10.9	19.1	10.4	17.6	11.5	21.0	7.4	9.9
TIC1	5130.6	7.2	3349.4	7.5	1830.0	2.8	590.0	3.0	1790.0	2.9	550.0	3.1	580.0	2.2	920.0	2.9	7070.0	3.6	3830.0	3.3	12540.0	4.0	550.0	2.5
WBIC1	5.0	3.4	5.2	3.2	2.2	0.6	2.2	0.6	2.2	0.5	2.3	0.5	1.9	1.4	3.9	2.4	7.3	3.9	5.9	3.3	10.0	5.1	2.6	1.8
WIM1	13.4	16.6	13.9	15.9	5.7	6.7	6.1	6.1	5.9	6.7	6.3	6.2	2.9	4.0	4.6	6.0	5.7	6.9	5.4	6.7	6.1	7.0	3.7	4.9
WTIC1	2.1	2.3	2.2	2.2	1.2	1.9	1.3	1.8	1.2	2.0	1.3	1.8	1.2	1.5	2.0	2.5	2.7	3.7	2.4	3.2	3.1	4.5	1.6	1.9
BEC	1.8	43.5	8.8	37.8	1.5	11.7	4.1	6.4	1.2	13.0	4.4	7.7	3.4	10.9	11.1	18.1	23.1	26.7	18.3	23.4	31.2	32.1	5.8	13.6
BEM	53.5	15.0	56.2	12.0	22.7	3.7	24.1	1.0	25.5	3.9	27.2	1.0	9.1	0.2	15.9	0.9	20.3	2.2	19.0	1.7	21.7	3.3	12.0	0.3
BIC1	32.0	68.2	19.7	70.7	14.3	23.8	5.9	24.8	14.2	25.6	5.7	26.7	5.4	22.1	21.7	33.0	53.9	44.5	40.6	40.2	77.2	51.4	9.5	26.4
TIC2	26.4	14.8	23.4	15.1	4.0	5.8	1.6	6.0	4.2	5.9	1.8	6.2	2.6	4.4	6.7	5.8	13.5	7.0	10.7	6.5	21.6	7.9	3.9	5.1
TIM1	7.8	46.3	7.7	47.1	4.4	12.5	4.4	13.2	4.5	12.7	4.4	13.4	3.5	4.9	5.2	10.7	6.2	15.7	5.9	14.0	6.6	18.2	4.3	7.2
TIC3	49.4	3.9	51.6	3.9	6.5	1.5	7.8	1.5	7.4	1.5	8.7	1.5	3.6	1.2	6.9	1.5	27.4	1.8	14.6	1.7	48.6	1.9	4.9	1.4
WBIC2	12.5	5.9	12.5	5.9	5.0	2.2	4.9	2.2	4.9	2.2	4.8	2.2	5.0	2.3	9.4	4.2	15.7	7.1	13.2	6.0	19.5	8.8	6.6	3.0
WIM2	21.2	13.6	21.2	13.6	7.0	4.3	7.1	4.4	7.1	4.4	7.1	4.4	4.5	2.8	6.8	4.2	7.9	4.9	7.6	4.7	8.1	5.0	5.6	3.5
WTIC2	3.0	3.5	3.0	3.5	2.0	2.4	2.0	2.3	2.1	2.4	2.1	2.4	1.8	2.1	2.9	3.3	3.9	4.6	3.6	4.1	4.5	5.2	2.2	2.6
BIC2	14.0	54.1	12.1	55.1	7.4	18.3	5.8	18.9	7.6	19.5	6.0	20.2	3.6	17.6	11.1	25.9	22.5	32.7	18.1	30.4	29.8	35.9	6.0	21.1
BIM1	34.8	13.2	34.5	13.5	8.5	2.5	8.6	2.6	9.2	2.7	9.3	2.9	6.2	0.0	8.3	0.0	7.3	0.0	8.0	0.0	6.7	0.0	7.4	0.0
BIC3	27.8	45.8	29.3	45.3	7.9	16.6	8.9	16.4	8.1	17.7	9.1	17.5	4.8	15.1	14.6	22.1	28.7	28.5	23.3	26.2	36.6	32.0	7.9	18.0

TABLE 6.6. OPERATING RATING PROBLEM CRITICAL SECTIONS FOR SHALLOWATER CULVERT: 4' OF FILL

	CULV-5				RISA-2D TEXT				RISA-2D STRUC				RISA-2D LEFE CRG		RISA-2D LEFE Bowles		RISA-2D LEFE SPT/TCP		RISA-2D LEFE DCP		RISA-2D LEFE PMT		RISA-2D LEFE FWD	
	TL		RLL		TL		RLL		TL		RLL		max	min	max	min	max	min	max	min	max	min	max	min
	max	min	max	min	max	min	max	min	max	min	max	min	max	min	max	min	max	min	max	min	max	min	max	min
WBEC	-7.00	-0.61	13.77	0.03	384.38	0.76	18.55	1.69	174.02	0.76	18.36	1.69	32.87	0.12	13.58	-1.43	8.23	-2.17	9.53	-1.95	6.95	-2.45	21.83	-0.68
WEM	1.15	3.87	7.46	1.74	1.28	10.61	25.31	3.17	1.37	10.61	26.87	3.17	5.74	24.29	5.96	7.30	6.88	4.50	6.62	5.14	7.14	3.91	5.49	12.88
WTEC	-1.99	-0.10	10.34	0.41	5.50	0.65	174.45	1.09	6.31	0.65	165.41	1.09	15.72	1.95	3.85	1.99	0.13	2.44	1.11	2.25	-0.93	2.68	9.13	1.85
TEC	89.97	-0.42	15.04	-0.22	3.40	0.73	213.50	1.58	3.85	0.73	212.11	1.58	20.44	2.18	5.35	2.28	0.92	2.74	2.07	2.57	-0.29	2.95	11.88	2.12
TEM	0.00	7.20	-0.08	9.23	0.03	12.58	-0.09	19.02	0.05	12.58	-0.08	19.02	1.03	40.92	0.31	22.91	0.10	18.21	-0.15	19.43	0.04	16.98	0.61	30.20
TIC1	21.90	-0.25	34.65	-0.31	45.03	0.86	145.33	0.65	46.55	0.86	157.56	0.65	128.50	1.78	105.08	0.28	17.42	-0.80	29.46	-0.44	11.20	-1.31	151.01	1.08
WBIC1	1.60	2.18	1.44	2.41	4.16	11.25	4.18	10.11	4.14	11.25	4.08	10.11	5.49	4.05	3.76	1.13	3.22	-1.04	3.34	-0.33	3.12	-1.92	4.55	2.72
WIM1	1.39	1.88	1.26	2.07	3.37	4.60	3.01	5.20	3.24	4.60	2.89	5.20	6.78	7.74	3.88	5.45	3.03	4.90	3.23	5.02	2.87	4.82	5.18	6.42
WTIC1	1.09	1.42	1.00	1.54	1.71	1.81	1.41	2.09	1.71	1.81	1.41	2.09	1.50	2.65	0.18	2.26	-0.86	2.38	-0.49	2.31	-1.42	2.49	0.89	2.38
BEC	100.85	-0.83	18.44	-0.62	5.77	0.73	26.24	3.17	6.47	0.73	25.24	3.17	39.37	0.05	15.38	-1.55	9.12	-2.29	10.65	-2.06	7.61	-2.57	25.65	-0.78
BEM	0.20	8.82	0.08	11.59	1.30	29.73	1.11	109.59	1.02	29.73	0.83	109.59	4.33	770.64	0.44	183.35	-0.47	80.18	-0.27	103.64	-0.60	54.82	2.04	436.46
BIC1	29.14	-0.56	48.78	-0.62	41.61	1.22	102.98	1.10	43.29	1.22	108.82	1.10	99.98	2.03	25.15	1.30	8.43	1.38	12.26	1.31	4.76	1.53	58.13	1.57
TIC2	14.13	-0.19	16.21	-0.23	66.28	1.03	174.34	0.93	64.09	1.03	155.38	0.93	89.80	2.25	38.68	1.29	19.46	1.05	24.65	1.09	11.71	1.04	63.60	1.71
TIM1	0.16	4.22	0.18	4.11	0.30	15.59	0.33	14.58	0.33	15.59	0.36	14.58	1.14	38.48	0.57	19.07	0.50	12.88	0.50	14.61	0.53	10.72	0.79	27.32
TIC3	9.63	-0.10	9.13	-0.08	52.77	1.25	43.89	1.29	46.84	1.25	39.52	1.29	82.51	2.38	49.21	1.38	14.37	0.70	25.52	0.96	8.98	0.27	64.20	1.85
WBIC2	1.81	1.73	1.81	1.73	4.56	4.55	4.62	4.61	4.72	4.55	4.76	4.61	4.55	4.55	2.43	2.43	1.46	1.46	1.73	1.73	1.17	1.17	3.47	3.47
WIM2	1.56	1.51	1.56	1.51	4.74	4.74	4.69	4.69	4.73	4.74	4.69	4.69	7.41	7.41	4.92	4.92	4.25	4.25	4.41	4.40	4.13	4.12	5.98	5.98
WTIC2	1.21	1.20	1.21	1.20	1.76	1.76	1.77	1.77	1.73	1.76	1.74	1.77	2.04	2.04	1.25	1.25	0.92	0.92	1.01	1.01	0.80	0.80	1.62	1.62
BIC2	19.45	-0.49	22.76	-0.52	24.52	1.20	31.77	1.07	24.40	1.20	31.33	1.07	47.73	1.75	17.55	0.67	9.70	0.17	11.58	0.33	7.83	-0.07	30.16	1.18
BIM1	0.43	5.40	0.45	5.25	2.83	25.27	2.78	23.89	2.47	25.27	2.45	23.89	5.36	NA	2.32	NA	1.02	545.22	1.49	NA	-0.83	-4.93	3.62	NA
BIC3	13.40	-0.39	12.63	-0.37	31.15	1.32	27.57	1.36	31.32	1.32	27.67	1.36	47.44	2.05	16.67	1.17	8.28	0.98	10.37	1.01	6.18	0.99	30.01	1.55

The meaningful conclusion from this analysis is that CULV-5 should be used for *design* purposes. In general, they overestimate the demands and produce safe structures. However, for *load rating*, a much less conservative model, even an unconservative model, is desirable, because it will reduce the conservatism in the controlling critical sections without actually introducing unconservatism into the load rating.

### 7. Deflections

Deflection data were collected as a backup measure. Figure 6.20 shows the measured deflection in the culvert at the midspans. The live load deflections for four feet of fill are roughly half the magnitude of the live load deflections for two feet of fill. This corresponds with a conceptual understanding of increased load distribution through more fill.

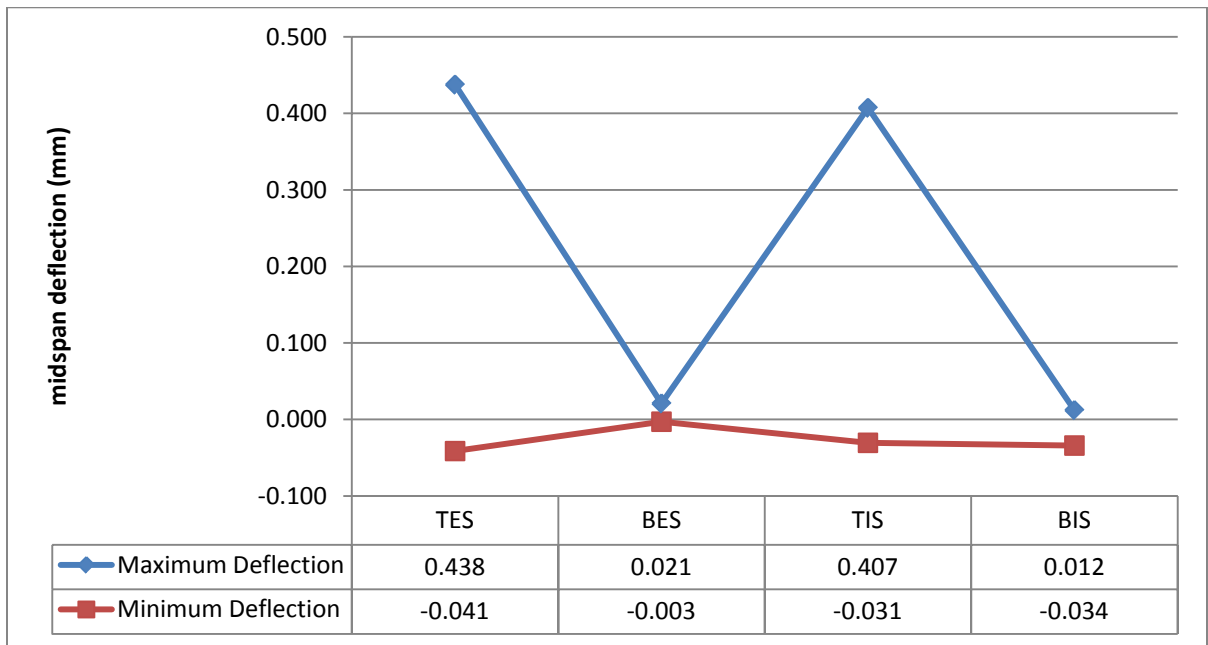

FIGURE 6.20. MEASURED DEFLECTIONS IN MILLIMETERS FOR THE SHALLOWATER CULVERT: 4' OF FILL

### 8. *Summary of Findings for the Shallowater Culvert with 4' of Fill*

From this case study the following findings are noted:

1. Predicted sign for live load moment corresponds to actual moment sign indicating excellent agreement between reality and the models.
2. Predicted magnitude for live load moment typically higher than actual moment magnitude and therefore conservative.
3. Scatter for predicted dead load moment is higher than for predicted live load moment (stdev = 1.15/0.44).
4. Critical sections for live load are not the same as critical sections for Operating Rating for all but CULV-5 WTEC and RISA-2D LEFE PMT BIM and these cases are not the controlling Operating Rating.
5. CULV-5 yields most conservative moments and among the worst Operating Rating.
6. RISA-LEFE ( $E_s$  per *Culvert Rating Guide*) yields least conservative moments and highest Operating Rating.

## 5. THE PLAINVIEW CULVERT INSTRUMENTED LOAD TEST

### 1. Culvert Condition

The Plainview culvert is located in Hale County on SH-194 approximately 100yd south of FM-70 in Plainview, Texas. Figure 6.21 shows the location of the Plainview test culvert. This culvert was built in 1991. The design is a Post-1977, 1958 era culvert design. It consists of four 10' wide by 6' tall barrels. The culvert is oriented perpendicular to the roadway underneath five lanes of traffic. The culvert showed very little distress.

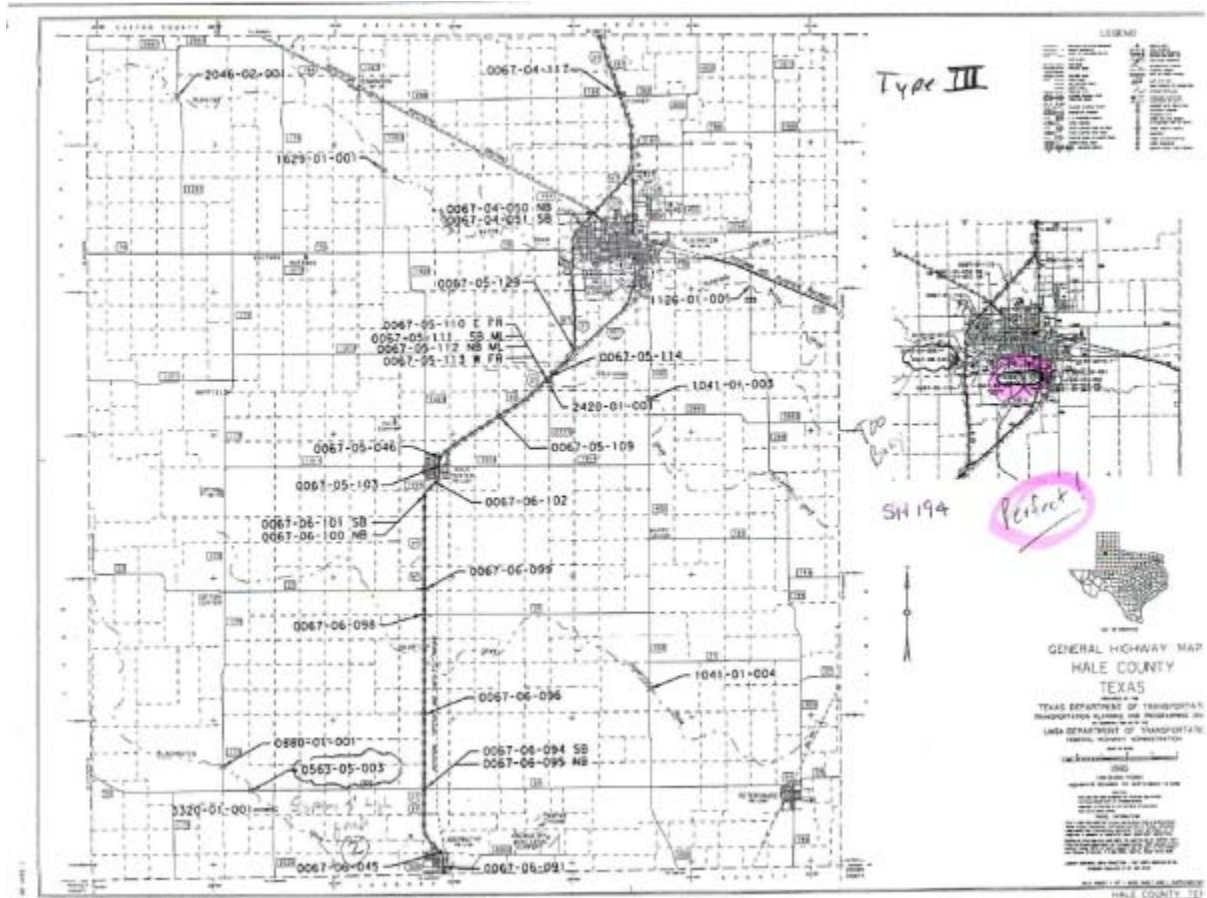

FIGURE 6.21. PLAINVIEW LOCATION.

## 2. Summary of Parameters

### 1. Culvert Test Parameters

Culvert dimensional data from the plan sheets showed 4 barrels, 10ft spans, 6ft height, 8.5in. thick top and bottom slabs, 7in. thick walls and 60ksi steel yield strength. According to the *MCEB*, 3ksi concrete was assumed for Level 1 and 2 analyses. For Level 2 and 3 analyses the tested compressive strength of 8ksi from the concrete cores was used. The truck weighed 47kips. The front single axles weighed 11.5kips, while the rear tandem axles weighed 35.5kips.

### 2. Soil Test Parameters

A soil unit weight of 120pcf was selected from the *Culvert Rating Guide*. A modulus of subgrade reaction,  $k$ , of 150pci from *Culvert Rating Guide* was used for Level 2 analysis. The modulus of elasticity for the soil,  $E_s$ ; was determined for a two layer soil system using seven different methods. The first modulus value represents the layer from the ground surface to slightly below the bottom of the culvert. The second modulus value is used for the native soil beneath the culvert.

1. 8 / 20 ksi from *Culvert Rating Guide*
2. 6 / 9 ksi from Bowles and McCarthy textbooks
3. 23 / 5 ksi from Unconfined Compressive Strength (UCS) and Standard Penetration Test (SPT)
4. 25 / 10 ksi from Texas Cone Penetration Test (TCP)
5. 23 / 4 ksi from Dynamic Cone Penetrometer (DCP)
6. 0.9 / 0.8 ksi from Pressuremeter (PMT)
7. 8 / 8 ksi from Falling Weight Deflectometer (FWD)

Testing was performed under three and a half foot of fill including the pavement surface.

### 3. Instrumentation Plan

The instrumentation plan involved placing 4in. electrical resistance strain gages at every critical section on the inside of the two northernmost barrels. An attempt was made to place strain gages on the exterior of the top slab and at the top corner exterior walls opposite the corresponding interior gages. However, there was greater fill depth than expected making gage placement impossible without causing significant damage to the pavement surface. Linear displacement gages were placed at the centerline of the top and bottom slabs. Figure 6.22 shows the location of the strain gages (in purple) and the linear displacement gages (in blue).

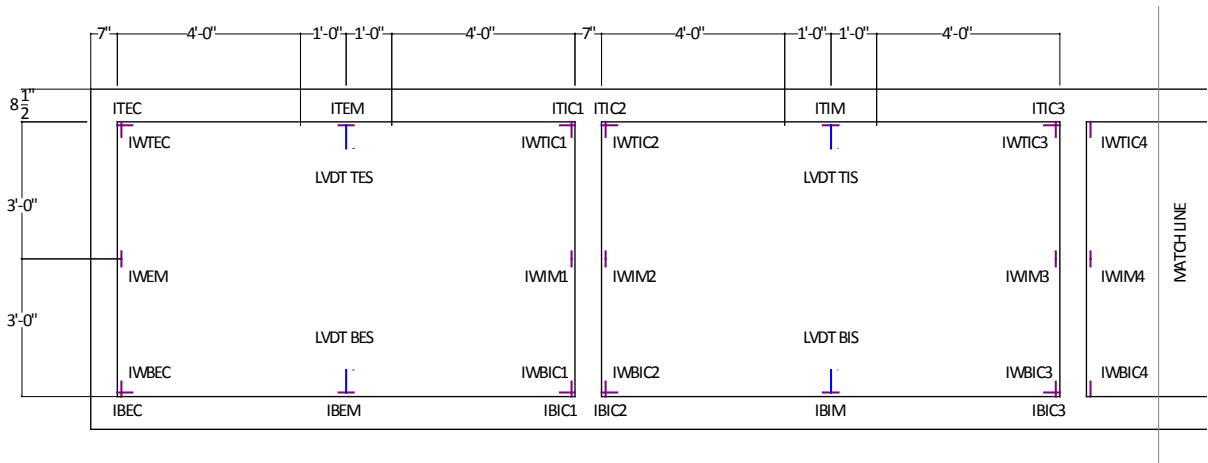

FIGURE 6.22. PLAINVIEW INSTRUMENTATION PLAN.



#### 4. Load Rating

Figure 6.23 shows the normal load rating for the Plainview culvert under three and a half feet of fill using all the different models and soil properties. All but one method produced positive ratings. Seven of the analysis methods produced Operating Ratings great than HS-20. Four of the methods produced inventory ratings above HS-20.

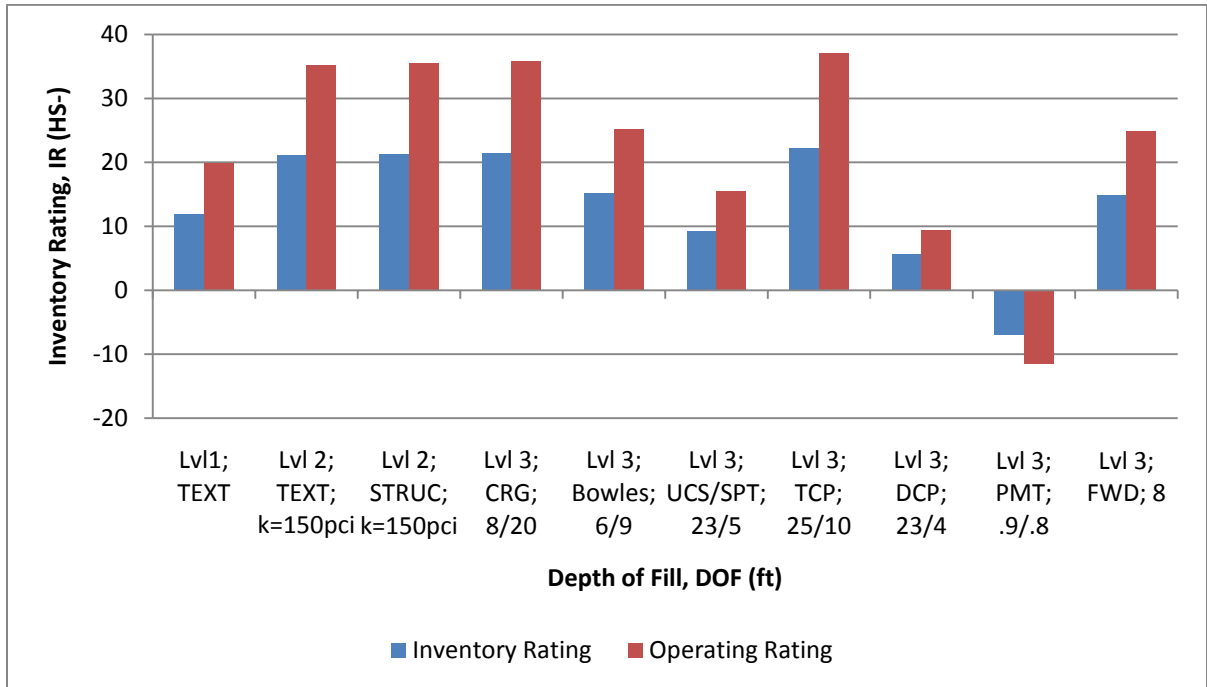

FIGURE 6.23. LOAD RATING FOR PLAINVIEW CULVERT: 3.5' OF FILL

### 5. Live Load Moment – Predicted and Measured

Figure 6.24 shows the live load moment envelope for the Plainview culvert beneath three and a half feet of fill. The blue and red lines show the measured moment as well as error bars which show a reasonable range due to variations in concrete modulus, cracked moment of inertia, and the nature of four inch strain gages which measure average strain over the gage length and not the actual strain at the critical section. The measured moment is less than the predicted moment for all models.

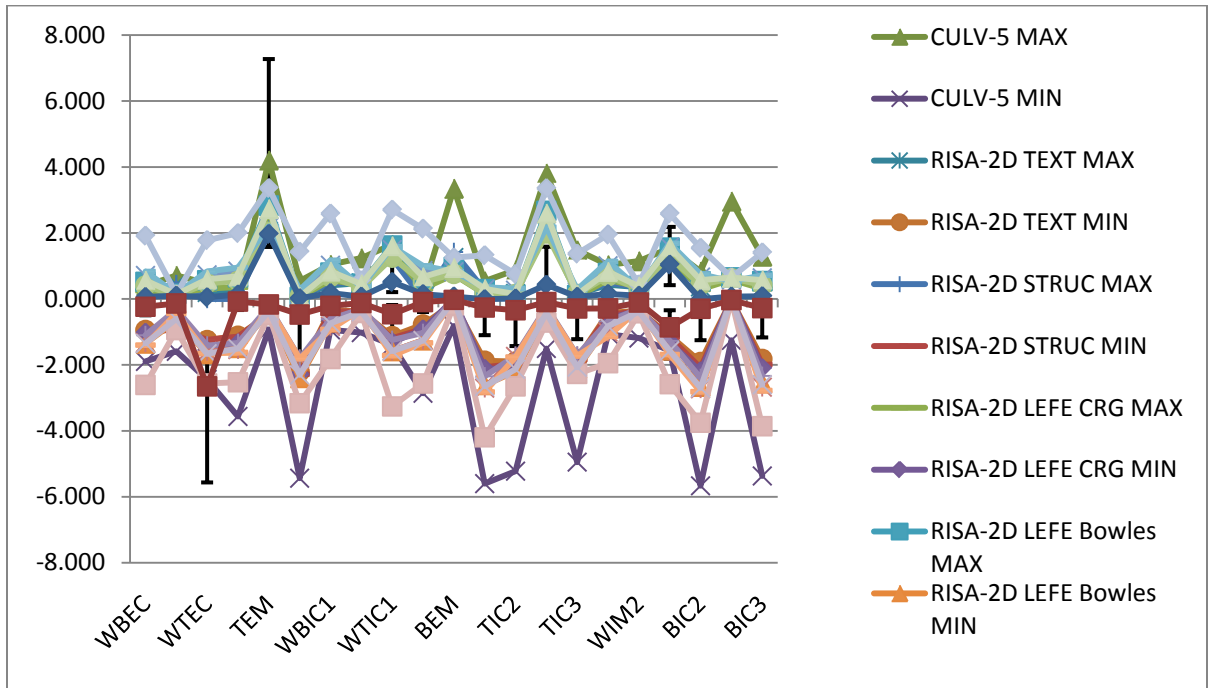

FIGURE 6.24. LIVE LOAD MOMENTS PREDICTED AND MEASURED FOR PLAINVIEW CULVERT: 3.5' OF FILL.

### 6. Dead Load Moment – Predicted

Figure 6.25 shows the predicted dead load distributions for the Plainview culvert beneath three and a half feet of fill for all models. The models predict similar directions for the dead load effect, except for exterior corner locations.

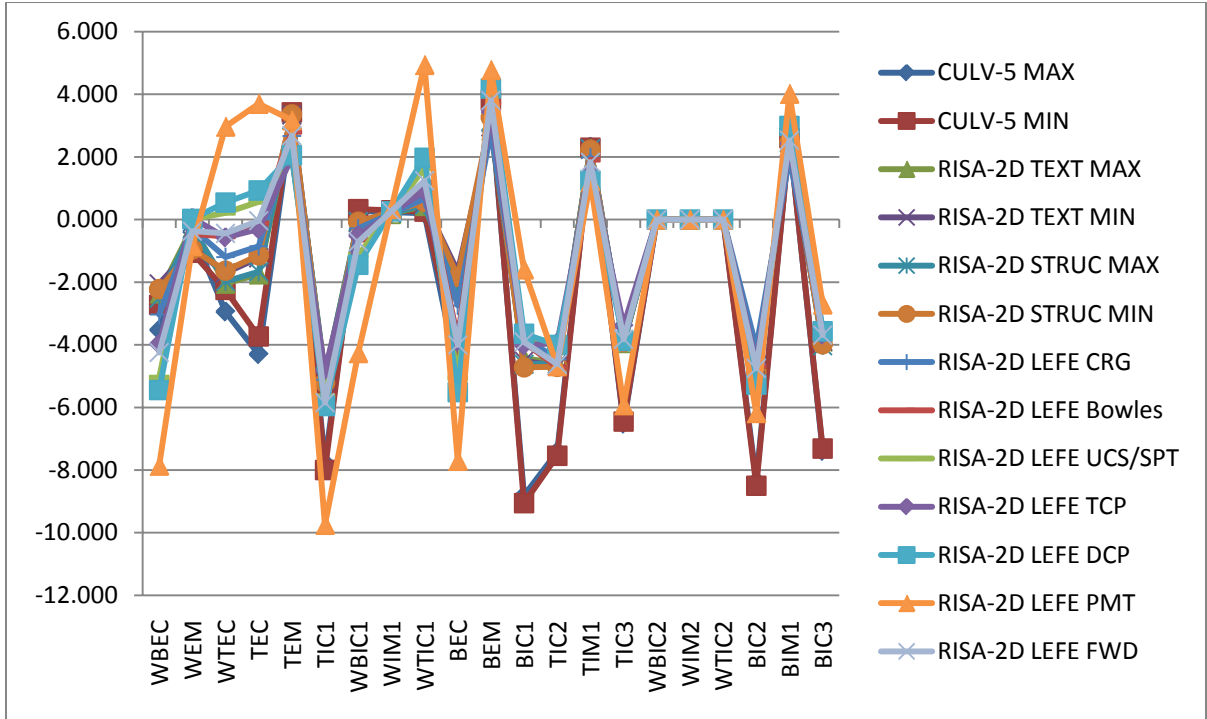

FIGURE 6.25. DEAD LOAD PREDICTED FOR PLAINVIEW CULVERT: 3.5' OF FILL.

### 7. Live Load “Goodness”

Figure 6.26 shows the goodness plot for the Plainview culvert beneath three and a half feet of fill. The plot shows the number of critical sections which fall into each threshold. According to the plot, CULV-5 model produces the most conservative predictions. The least conservative model is the RISA-2D with LEFE using the *Culvert Rating Guide* and the Texas Cone Penetrometer soil moduli.

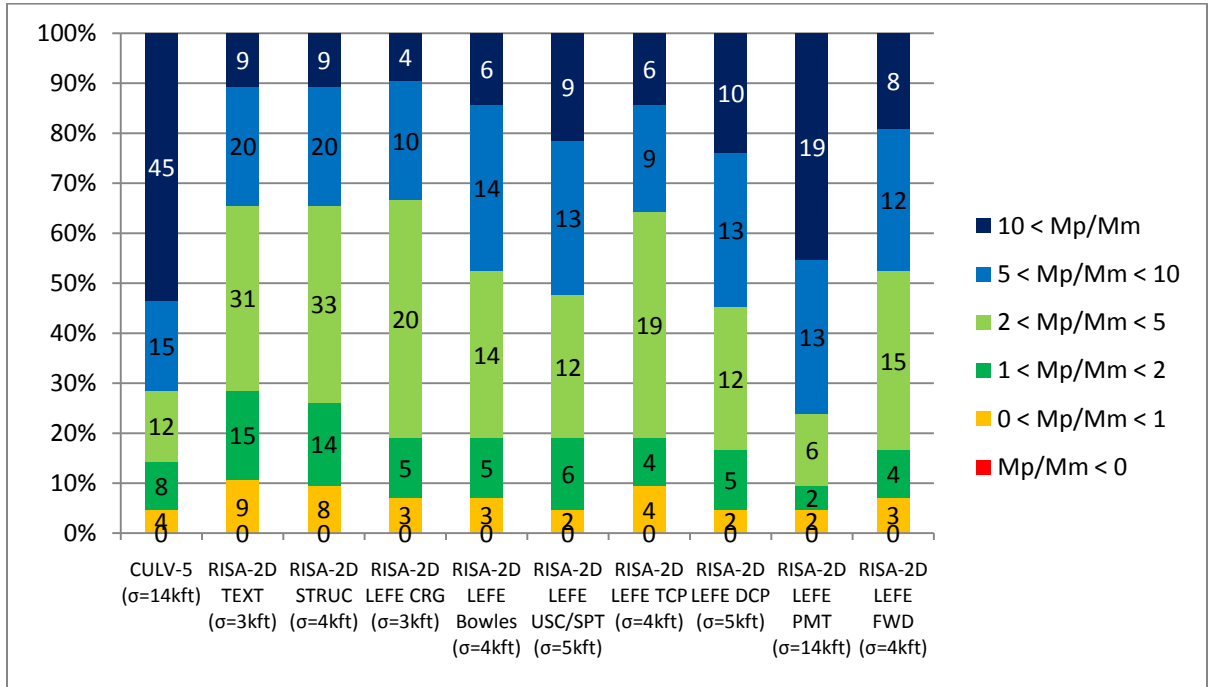

FIGURE 6.26. LIVE LOAD GOODNESS PLOT FOR PLAINVIEW CULVERT: 3.5' OF FILL

Also included in Figure 6.26 is the average standard deviation of the ratios for each of the models. The smaller the average standard deviation, the better the model fit. By this measure, CULV-5 and RISA-2D with LEFE using the Pressuremeter data are the least appropriate for accurately predicting the live load moments. RISA-2D with LEFE using the *Culvert Rating Guide* soil modulus values and RISA-2D with Springs using textbook assumptions are the most appropriate models with the least amount of scatter and the most accurate prediction of the live load moment envelope shape.

### 8. Load Rating “Goodness”

Figure 6.27 shows the number of critical sections in each threshold for each model. Overall, the models produce very good load ratings. This is more likely due to the adequate or even over-conservative structural design.

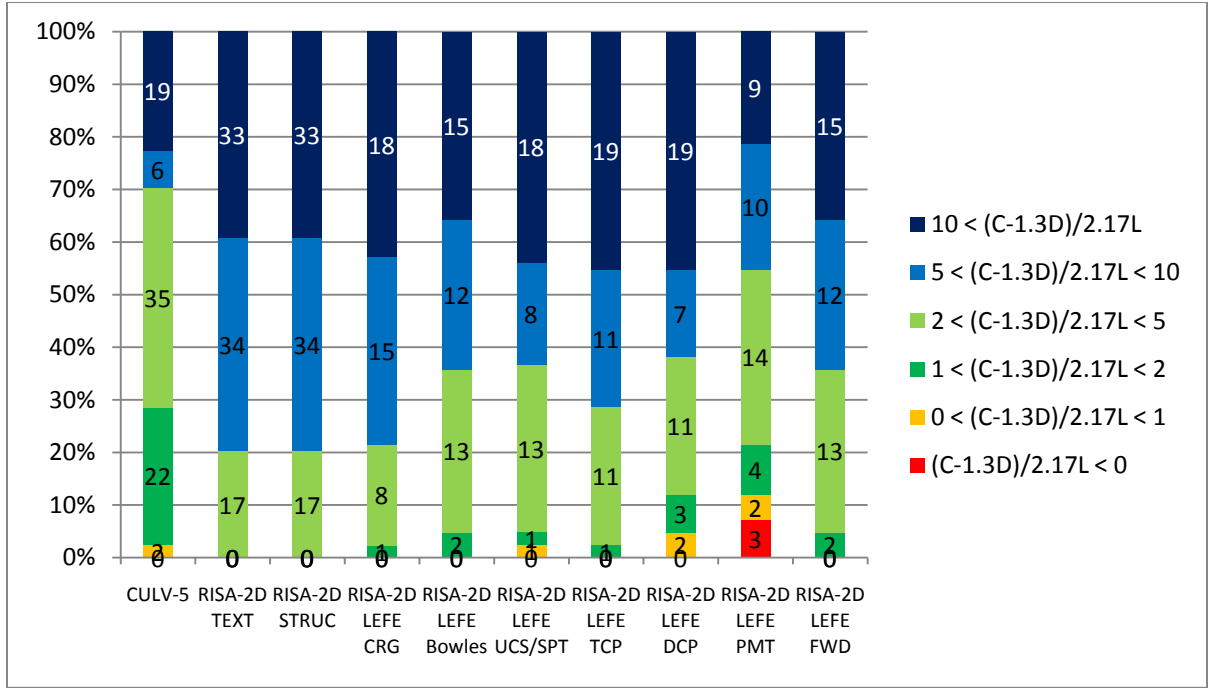

FIGURE 6.27. LOAD RATING GOODNESS PLOT FOR PLAINVIEW CULVERT: 3.5' OF FILL

### 9. Critical Section Analysis

IT IS IMPORTANT TO NOTE THE CRITICAL SECTIONS WHERE PROBLEM AREAS OCCUR FOR THE LIVE LOAD PREDICTION AND THE OPERATING RATING. THE FOLLOWING TABLES SHOW ALL THE CRITICAL SECTIONS IN EVERY MODEL. TABLE 6.7 HIGHLIGHTS THE PROBLEM CRITICAL SECTIONS FOR THE PREDICTED LIVE LOAD DEMAND. TABLE 6.8 SHOWS THE PROBLEM CRITICAL SECTIONS FOR THE LOAD RATING. CAREFUL INSPECTION OF

Table 6.7 and Table 6.8 reveals that there is no overlap between the two sets of problem critical sections. It is also meaningful to note that far fewer sections are problem sections than for the older Shallowater culvert.

**TABLE 6.7. LIVE LOAD DEMAND PROBLEM CRITICAL SECTIONS FOR PLAINVIEW CULVERT: 3.5' OF FILL**

	CULV-5				RISA-2D TEXT				RISA-2D STRUC				RISA-2D LEFE CRG		RISA-2D LEFE Bowles		RISA-2D LEFE UCS/SPT		RISA-2D LEFE TCP		RISA-2D LEFE DCP		RISA-2D LEFE PMT		RISA-2D LEFE FWD				
	TL		RLL		TL		RLL		TL		RLL		max	min	max	min	max	min	max	min	max	min	max	min	max	min	max	min	
	max	min	max	min	max	min	max	min	max	min	max	min	max	min	max	min	max	min	max	min	max	min	max	min	max	min	max	min	
WBEC	0.1	8.0	6.8	6.2	0.3	4.0	3.3	3.2	1.7	4.5	4.5	3.8	4.2	4.3	8.7	5.7	12.0	5.6	6.9	4.6	14.0	5.9	32.3	11.0	9.5	5.7	14.0	5.7	
WEM	7.2	8.8	3.4	11.5	4.5	3.6	0.8	6.2	4.5	3.7	0.8	6.4	1.8	4.0	1.6	4.7	1.4	3.0	0.9	2.3	1.6	3.2	1.4	6.8	1.4	4.4	4.4	5.4	
WTEC	1.1	0.9	9.6	0.8	0.5	0.5	4.0	0.4	1.0	0.5	4.6	0.4	6.3	0.6	11.4	0.6	14.9	0.6	9.5	0.5	16.8	0.6	36.1	1.0	12.0	0.6	12.0	0.6	
TEC	1.0	44.2	1.9	40.1	1.1	13.9	1.6	10.2	0.7	14.2	1.8	10.5	2.7	16.8	5.0	18.4	6.4	19.1	4.2	16.6	7.2	20.2	15.1	31.4	5.2	18.7	18.7	18.7	
TEM	2.1	5.5	2.1	4.9	1.1	2.8	1.2	2.2	1.1	2.8	1.2	2.2	1.3	2.2	1.4	2.4	1.1	1.6	1.0	1.4	1.1	1.6	1.7	2.9	1.4	2.2	2.2	2.2	
TIC1	25.0	11.2	19.2	11.5	4.7	4.4	0.5	4.7	4.8	4.6	0.5	4.8	2.3	4.8	2.7	5.1	6.7	3.8	3.5	3.8	12.3	3.8	65.3	6.7	3.1	4.9	4.9	4.9	
WBIC1	5.7	4.4	5.9	4.3	2.3	1.6	2.3	1.5	2.6	1.8	2.7	1.7	3.2	2.8	4.5	3.4	5.8	3.9	3.7	2.9	6.6	4.4	14.6	8.6	4.7	3.5	3.5	3.5	
WIM1	17.5	8.3	17.9	8.0	6.6	3.1	7.0	2.9	6.9	3.2	7.3	2.9	6.0	3.0	6.7	3.3	5.2	2.6	4.8	2.5	5.3	2.6	8.2	3.5	6.5	3.2	3.2	3.2	
WTIC1	3.2	3.0	3.2	2.9	2.3	2.4	2.4	2.3	2.3	2.6	2.4	2.4	2.8	2.8	3.2	3.4	2.9	3.4	2.4	2.7	3.1	3.7	5.3	7.0	3.1	3.4	3.4	3.4	
BEC	0.6	30.2	1.9	26.7	0.8	8.2	1.5	5.0	0.1	9.6	2.1	6.5	2.1	9.8	4.2	13.3	5.9	13.3	3.5	10.9	6.9	14.1	14.6	27.1	4.6	13.3	13.3	13.3	
BEM	44.6	28.2	46.0	24.8	16.5	4.6	17.3	1.4	18.6	4.9	19.5	1.8	10.1	0.1	13.3	0.7	11.3	1.6	10.4	0.5	11.3	2.1	17.2	6.7	13.0	0.8	0.8	0.8	
BIC1	5415.7	20.9	4136.0	21.4	2800.0	6.9	1970.0	7.2	2610.0	7.7	1780.0	7.9	1530.0	8.1	2990.0	10.0	2960.0	10.3	1550.0	9.0	3530.0	10.8	13210.0	16.0	3050.0	10.1	10.1	10.1	10.1
TIC2	60.5	15.1	55.3	15.3	11.2	5.4	7.2	5.6	12.8	5.6	8.7	5.8	3.4	6.2	8.1	6.5	18.2	5.1	10.1	5.0	21.5	5.2	52.1	7.8	10.1	6.3	6.3	6.3	
TIM1	8.9	15.8	8.9	15.9	4.8	5.2	4.8	5.4	4.9	5.3	4.8	5.5	5.8	4.3	6.2	4.8	5.0	2.9	4.6	2.6	5.1	3.0	7.8	7.6	6.1	4.5	4.5	4.5	
TIC3	22.0	17.0	22.6	16.9	1.8	6.3	2.1	6.2	2.1	6.3	2.4	6.3	1.0	7.2	1.7	7.3	3.3	6.0	2.3	5.9	4.3	5.9	20.9	7.8	2.0	7.1	7.1	7.1	
WBIC2	6.9	3.7	6.9	3.7	2.9	1.5	2.9	1.5	3.3	1.7	3.3	1.7	3.9	2.0	5.3	2.7	6.8	3.5	4.6	2.4	7.7	4.0	13.1	6.8	5.6	2.9	2.9	2.9	
WIM2	11.7	10.9	11.7	10.9	3.6	3.3	3.6	3.3	3.6	3.3	3.6	3.3	3.7	3.4	4.0	3.6	3.2	2.9	3.0	2.8	3.2	2.9	4.4	4.0	3.9	3.5	3.5	3.5	
WTIC2	1.5	1.8	1.5	1.8	1.1	1.3	1.1	1.3	1.1	1.3	1.1	1.3	1.3	1.5	1.5	1.8	1.5	1.8	1.2	1.5	1.6	2.0	2.5	3.0	1.5	1.8	1.8	1.8	
BIC2	8387.2	18.7	7624.8	19.0	3660.0	6.2	2980.0	6.4	4070.0	6.8	3390.0	7.0	2910.0	7.4	5350.0	8.9	6650.0	9.1	4230.0	8.0	7540.0	9.4	15470.0	12.6	5710.0	9.0	9.0	9.0	
BIM1	40.7	34.0	40.4	34.5	8.6	0.9	8.6	0.9	9.1	0.8	9.1	0.9	8.1	0.1	9.0	0.2	7.9	0.0	8.6	0.1	7.3	0.0	9.0	0.7	8.9	0.1	0.1	0.1	
BIC3	15.5	19.3	16.0	19.1	4.1	6.5	4.6	6.5	4.6	7.1	5.0	7.0	3.8	7.6	6.7	9.2	8.0	9.6	5.2	8.4	8.9	10.0	17.4	13.9	7.1	9.3	9.3	9.3	

**TABLE 6.8. OPERATING RATING PROBLEM CRITICAL SECTIONS FOR PLAINVIEW CULVERT: 3.5' OF FILL**

	CULV-5				RISA-2D TEXT				RISA-2D STRUC				RISA-2D LEFE CRG		RISA-2D LEFE Bowles		RISA-2D LEFE UCS/SPT		RISA-2D LEFE TCP		RISA-2D LEFE DCP		RISA-2D LEFE PMT		RISA-2D LEFE FWD			
	TL		RLL		TL		RLL		TL		RLL		max	min	max	min	max	min	max	min	max	min	max	min	max	min	max	min
	max	min	max	min	max	min	max	min	max	min	max	min	max	min	max	min	max	min	max	min	max	min	max	min	max	min	max	min
WBEC	171.69	1.26	11.37	2.16	233.95	3.78	20.26	5.07	54.91	3.46	19.47	4.46	24.28	3.08	13.72	1.56	11.35	0.87	17.21	2.03	10.19	0.54	5.69	0.64	12.95	1.45	1.45	1.45
WEM	3.66	4.54	9.72	3.05	5.53	11.47	39.36	5.83	5.70	11.43	40.97	5.94	14.19	10.76	17.00	8.75	16.52	15.08	23.83	19.35	14.34	14.23	21.90	5.69	18.93	9.64	9.64	9.64
WTEC	86.39	1.22	8.71	1.81	169.70	3.10	17.99	3.93	98.24	3.41	20.65	4.29	13.61	3.19	6.34	3.39	3.85	4.04	7.64	3.98	3.00	4.08	0.04	3.58	5.86	3.47	3.47	3.47
TEC	41.94	0.99	57.58	1.26	68.28	5.44	55.76	8.04	109.19	5.63	50.51	8.24	32.59	5.36	16.77	5.38	12.25	5.65	20.41	5.85	10.48	5.56	3.60	4.67	15.89	5.36	5.36	5.36
TEM	1.75	6.49	1.67	7.51	3.30	12.48	3.09	16.17	3.49	16.10	3.26	20.83	3.10	19.67	2.86	18.46	4.07	25.01	4.36	27.54	4.02	24.53	2.29	15.57	3.00	19.34	19.34	
TIC1	33.32	1.38	43.93	1.30	149.55	4.80	1559.42	4.49	152.91	5.18	1462.94	4.87	313.63	4.88	284.12	4.35	112.42	5.85	203.90	6.35	62.83	5.72	14.45	4.55	245.99	4.54	4.54	4.54
WBIC1	2.96	3.77	2.82	3.95	8.15	9.59	8.17	10.18	7.29	8.72	7.22	9.21	6.36	5.20	5.00	3.79	4.40	2.66	5.80	4.63	4.09	2.06	2.94	4.86	3.57	3.57	3.57	
WIM1	2.50	3.44	2.40	3.60	6.72	9.08	6.32	9.75	6.57	9.16	6.16	9.91	7.55	9.47	6.61	8.98	8.60	11.32	9.45	11.68	8.48	11.33	5.32	8.64	6.85	9.24	9.24	
WTIC1	1.90	2.49	1.83	2.58	2.42	3.28	2.24	3.54	2.42	3.21	2.25	3.45	1.90	3.05	1.34	2.86	1.14	3.15	1.95	3.43	0.87	3.10	0.59	2.54	1.31	2.90	2.90	
BEC	49.15	1.00	54.15	1.37	71.01	7.24	56.26	12.97	662.62	6.32	40.88	10.24	43.68	5.79	23.82	3.44	18.48	2.43	29.16	4.07	16.34	1.95	8.73	0.16	22.38	3.25	3.25	3.25
BEM	2.10	7.74	1.98	9.09	6.32	41.43	5.95	135.73	5.73	53.60	5.36	148.86	11.01	3643.43	7.37	432.31	8.29	185.17	9.77	528.52	8.11	141.92	4.87	47.46	7.48	344.95	344.95	
BIC1	35.54	1.33	47.12	1.26	53.08	6.41	75.87	6.18	59.40	6.41	87.64	6.17	95.64	6.48	49.48	5.21	49.64	5.06	96.14	5.75	41.16	4.91	9.44	3.79	48.50	5.12	5.12	
TIC2	20.36	1.49	22.43	1.44	92.09	5.72	145.30	5.47	83.69	6.14	123.69	5.89	307.01	5.63	132.20	5.27	56.46	7.05	100.78	7.20	47.87	6.98	20.61	4.39	105.45	5.48	5.48	
TIM1	2.13	3.40	2.15	3.35	3.95	10.30	4.00	9.84	4.12	13.44	4.17	12.88	3.56	16.12	3.36	14.06	4.47	21.10	4.73	24.11	4.43	20.21	2.88	7.94	3.49	14.94	14.94	
TIC3	11.79	1.73	11.42	1.76	123.88	6.10	103.15	6.18	109.00	6.72	92.45	6.80	220.57	6.07	130.22	5.87	67.28	7.27	95.14	7.55	52.14	7.21	12.27	4.57	109.70	6.03	6.03	
WBIC2	3.17	3.06	3.17	3.06	7.63	7.63	7.62	7.62	6.78	6.78	6.92	6.92	5.75	5.75	4.24	4.24	3.32	3.32	4.89	4.89	2.95	2.95	1.72	1.72	4.05	4.05		
WIM2	2.84	2.75	2.84	2.75	9.26	9.26	9.20	9.20	9.38	9.38	9.33	9.33	9.10	9.10	8.48	8.48	10.73	10.73	11.20	11.20	10.73	10.73	7.66	7.66	8.74	8.74		
WTIC2	2.12	2.09	2.12	2.09	2.94	2.94	2.95	2.95	2.89	2																		

The culmination of this data suggests that CULV-5 or RISA-2D with spring analyses are appropriate to be used to design culverts. However, safe, less conservative load ratings can be determined using RISA-2D with LEFE. In general, all the models overestimate the demands and produce safe structures. However, for load rating, a much less conservative model, even an unconservative model, is desirable, because it will reduce the conservatism in the controlling critical sections without actually introducing unconservatism into the load rating.

### 10. Deflections

Deflection data were collected as a backup measure. Figure 6.28 shows the measured deflection in the culvert at the midspans. In the top spans the maximum deflection inward (positive) was around 0.25 millimeter. Some very slight outward deflection (negative) was also recorded. Deflections in the bottom slabs were essentially negligible.

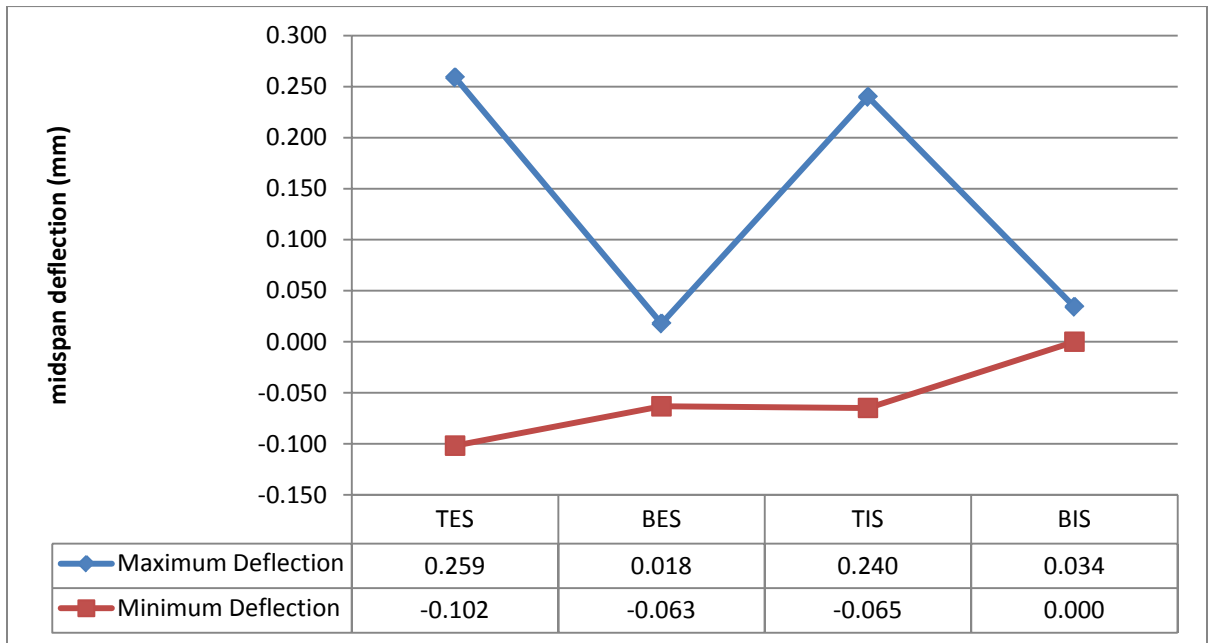

FIGURE 6.28. MEASURED DEFLECTIONS IN MILLIMETERS FOR THE PLAINVIEW CULVERT: 3.5' OF FILL



### ***11. Summary of Findings for the Plainview Culvert***

From this case study the following findings are noted:

1. Predicted sign for live load moment corresponds to actual moment sign indicating excellent agreement between reality and the models.
2. Predicted magnitude for live load moment typically higher than actual moment magnitude and therefore conservative.
3. Scatter for predicted dead load moment is higher than for predicted live load moment (stdev = 0.77/0.36).
4. Critical sections for live load are not the same as critical sections for Operating Rating.
5. CULV-5 yields most conservative moments and among the worst Operating Rating.
6. RISA-LEFE ( $E_s$  per *Culvert Rating Guide*) yields least conservative moments and highest Operating Rating.

## 6. THE TULIA CULVERT INSTRUMENTED LOAD TEST

### 1. Culvert Condition

The Tulia culvert is located in Swisher County approximately 8 miles east of Tulia, Texas on FM-1318. Figure 6.29 shows the location of the Tulia test culvert. This culvert was built in 1951. The design is a 1948 transition era culvert designed under the THD Supplement No. 1. It consists of five 6ft wide by 6ft tall barrels. This culvert is oriented perpendicular to the two lane FM road. It is in excellent condition and shows evidence of board form work.



FIGURE 6.29. TULIA LOCATION.

## 2. Summary of Parameters

### 1. Culvert Test Parameters

Culvert dimensional data from the plan sheets show 5 barrels, 6ft spans, 6ft height, 6in. thick top and bottom slabs, 7in. thick walls and 36ksi steel yield strength. According to the *MCEB*, 3ksi concrete was assumed for Level 1 and 2 analyses. For Level 2 and 3 analyses the tested compressive strength of 9.75ksi from the concrete cores was used. The truck weighed 51kips. The front single axles weighed 12.3kips, while the rear tandem axles weighed 38.7kips.

### 2. Soil Test Parameters

A soil unit weight of 120pcf was selected from the *Culvert Rating Guide*. A modulus of subgrade reaction,  $k$ , of 150pci from *Culvert Rating Guide* was used for Level 2 analysis. The modulus of elasticity for the soil,  $E_s$ ; was determined for a two layer soil system using seven different methods. The first modulus value represents the layer from the ground surface to slightly below the bottom of the culvert. The second modulus value is used for the native soil beneath the culvert.

1. 8 / 20 ksi from *Culvert Rating Guide*
2. 6 / 13 ksi from Bowles and McCarthy textbooks
3. 18 / 4 ksi from Unconfined Compressive Strength (UCS) and Standard Penetration Test (SPT)
4. 18 / 6 ksi from Texas Cone Penetration Test (TCP)
5. 54 / 3 ksi from Dynamic Cone Penetrometer (DCP)
6. 0.3 / 1.9 ksi from Pressuremeter (PMT)
7. 9 / 9 ksi from Falling Weight Deflectometer (FWD)

Testing was performed under one and a half foot of fill including the pavement structure.

### 3. Instrumentation Plan

The instrumentation plan involved placing 4in. electrical resistance strain gages at every critical section on the inside of the two westernmost barrels. Strain gages were also placed on the exterior of the top slab and at the top corner exterior walls opposite the corresponding interior gages. However, during the backfill process, the gages on the middle spans were lost. Linear displacement gages were placed at the centerline of the top and bottom slabs. Figure 6.30 shows the location of the strain gages (in purple) and the linear displacement gages (in blue).

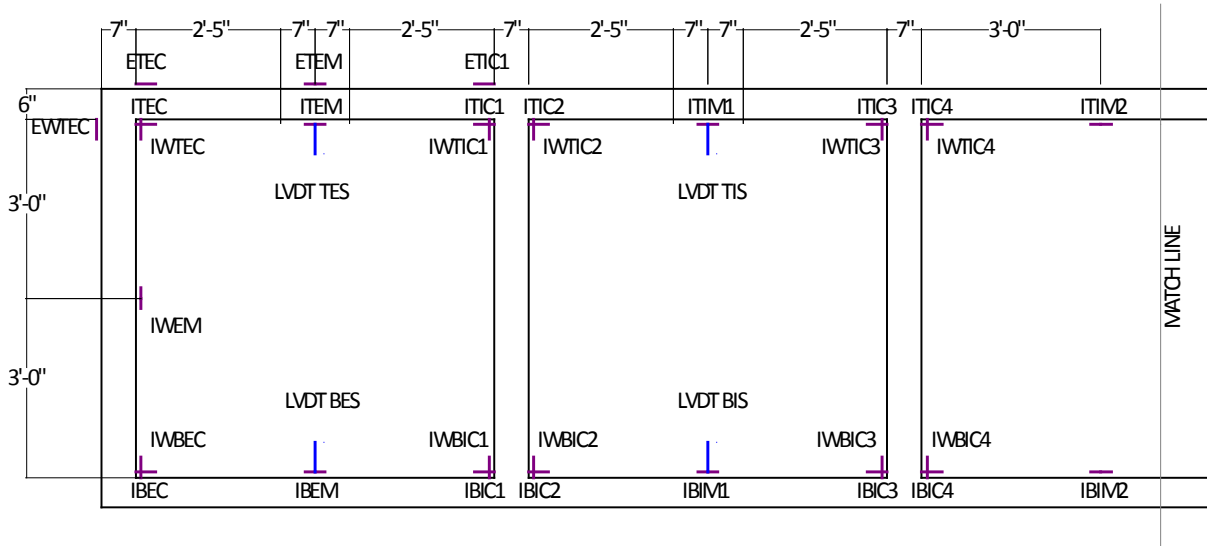

FIGURE 6.30. TULIA INSTRUMENTATION PLAN.

#### 4. Load Rating

Figure 6.31 shows the normal load rating for the Tulia culvert under one and a half feet of fill using all the different models and soil properties. Five methods produced positive ratings but no method produced a load rating, inventory or operating, above HS-20. Those models outlined in the *Culvert Rating Guide*, CULV-5, RISA-2D with Springs, and RISA-2D with LEFE, shows that the culvert should fail under live load. All other models show that the culvert should fail under the 1.5 feet of fill.

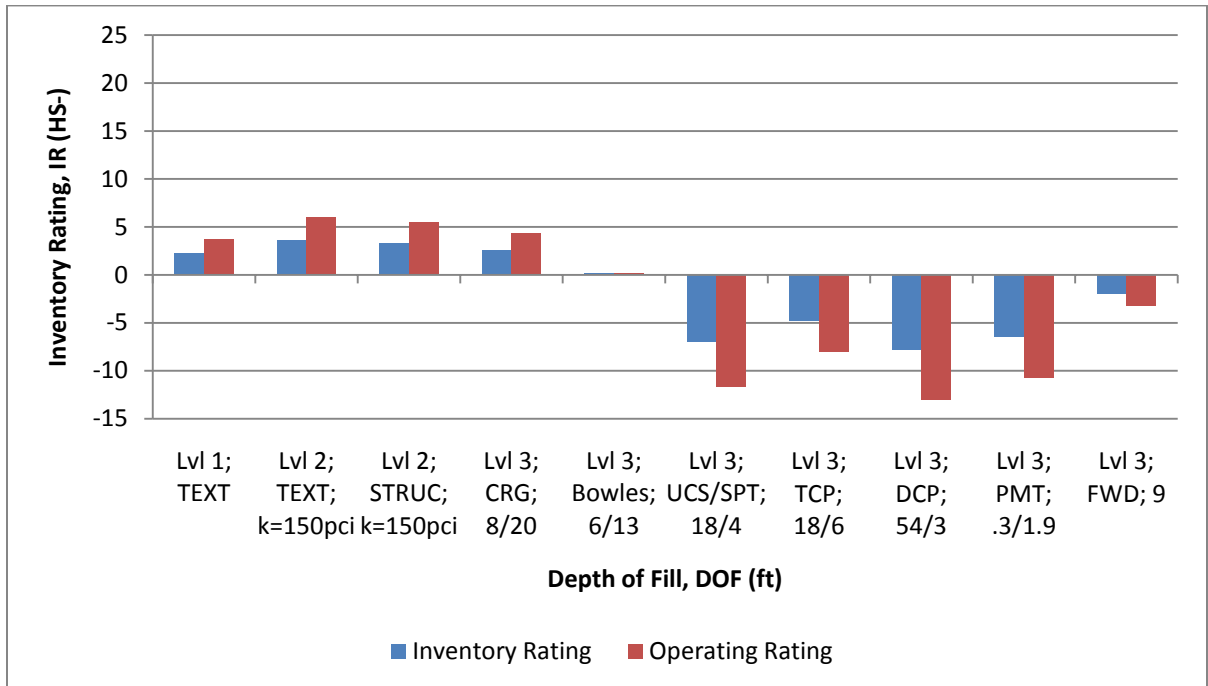

FIGURE 6.31. LOAD RATING FOR TULIA CULVERT: 1.5' OF FILL

Like the Shallowater culvert, the Tulia remains in service and clearly has *not* failed, this despite the fact that the load rating process would predict otherwise. Favorable environmental conditions, conservative structural properties, soil properties, and constitutive models for both the reinforced concrete and the soil can reasonably explain why this culvert has “stood the test of time.”

### 5. Live Load Moment – Predicted and Measured

Figure 6.32 shows the live load moment envelope for the Tulia culvert beneath one and a half feet of fill. The blue and red lines show the measured moment as well as error bars which show a reasonable range due to variations in concrete modulus, cracked moment of inertia, and the nature of four inch strain gages which measure average strain over the gage length and not the actual strain at the critical section. The measured moment is less than the predicted moment for all models.

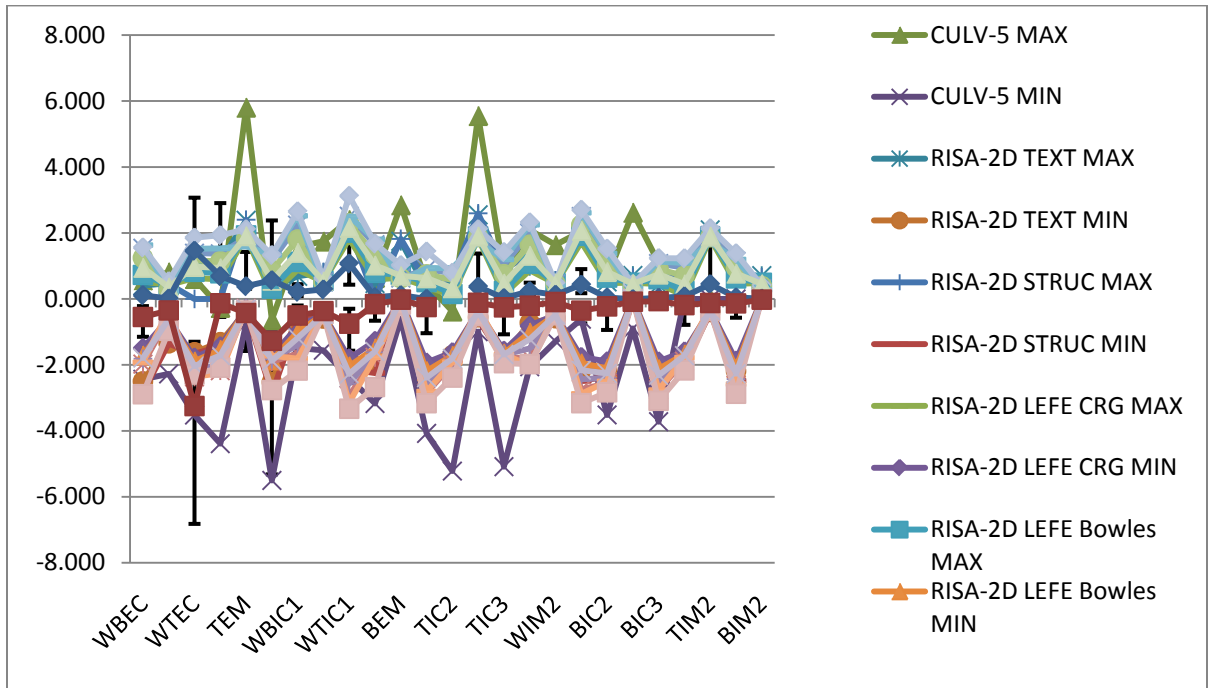

FIGURE 6.32. LIVE LOAD MOMENTS PREDICTED AND MEASURED FOR TULIA CULVERT: 1.5' OF FILL.

**6. Dead Load Moment – Predicted**

Figure 6.33 shows the predicted dead load distributions for the Tulia culvert beneath 1.5 feet of fill for all models. The models predict similar directions for dead load effect, except for some corner locations.

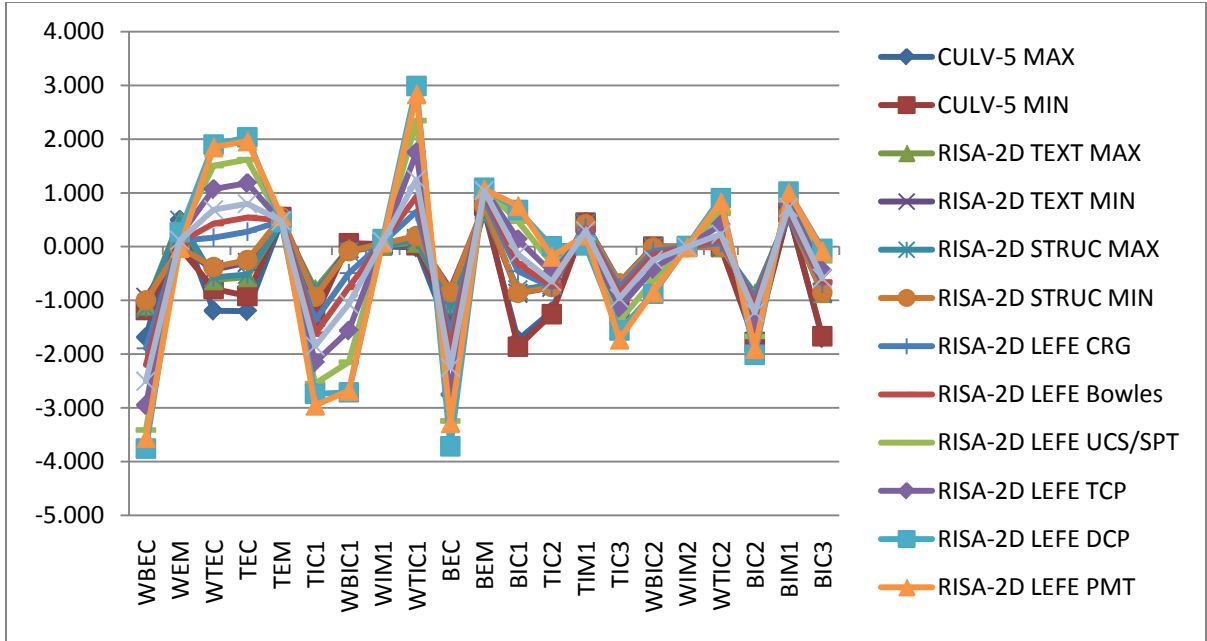

FIGURE 6.33. DEAD LOAD PREDICTED FOR TULIA CULVERT: 1.5' OF FILL.

## 7. Live Load “Goodness”

Figure 6.34 shows the goodness plot for the Tulia culvert beneath one and a half feet of fill. The plot shows the number of critical sections which fall into each threshold. In this case, CULV-5 has the most grossly over-conservative predictions, but it also shows some predictions that are in the wrong direction. However, in the general sense, the least conservative model is the RISA-2D with LEFE using the *Culvert Rating Guide* soil modulus.

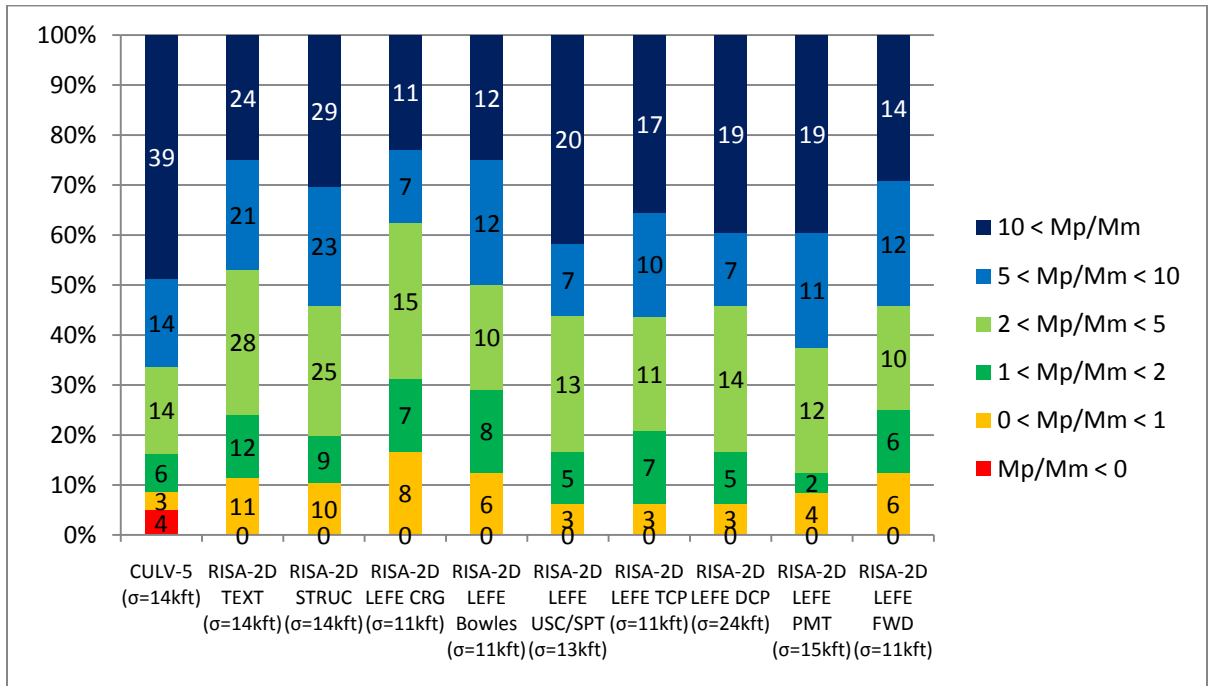

FIGURE 6.34. LIVE LOAD GOODNESS PLOT FOR TULIA CULVERT: 1.5' OF FILL

Also included in Figure 6.34 is the average standard deviation of the ratios for each of the models. The smaller the average standard deviation, the better the model fit. By this measure, the DCP based model is the least appropriate for accurately predicting the live load moments. RISA-2D with LEFE using the *Culvert Rating Guide*, textbook values, TCP and FWD soil moduli values all model the culvert with the same level of appropriateness with the least amount of scatter and the most accurate prediction of the live load moment envelope shape.



### 8. Load Rating “Goodness”

Figure 6.35 shows the number of critical sections in each threshold for each model. According to this plot, all the field test versions of the RISA-2D with LEFE model produce one or more critical sections in the structure that should fail under dead load. All the models show that the culvert should fail under live load, although CULV-5 indicates that in almost 60 percent of the critical sections, the culvert should have failed under the truck load.

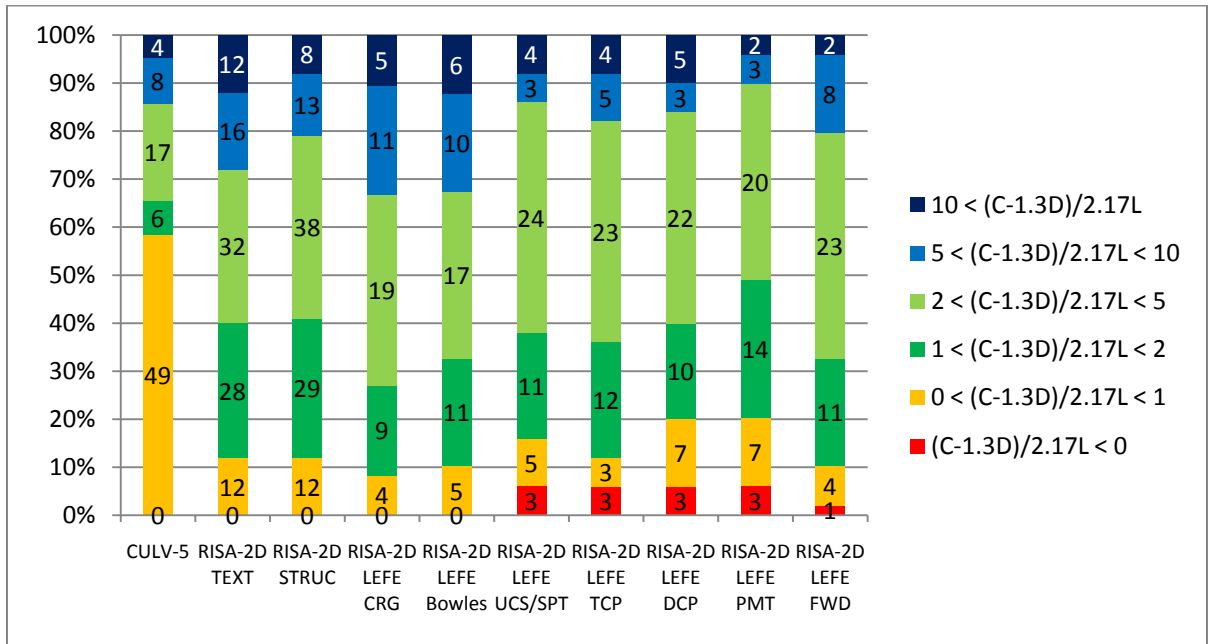

FIGURE 6.35. LOAD RATING GOODNESS PLOT FOR TULIA CULVERT: 1.5' OF FILL

### 9. Critical Section Analysis

For the most part, the critical sections which are problematic in the live load predictions do not produce problematic load ratings. Table 6.9 highlights the problem critical sections for the predicted live load demand. Table 6.10 shows the problem critical sections for the load rating. Careful inspection of Table 6.9 and Table 6.10 reveals that the only overlap is at the top wall exterior corner (WTEC) in CULV-5 and RISA-2D with springs. Even then this critical section does not control the load ratings.

TABLE 6.9. LIVE LOAD DEMAND PROBLEM CRITICAL SECTIONS FOR TULIA CULVERT: 1.5' OF FILL

	CULV-5				RISA-2D TEXT					RISA-2D STRUC					RISA-2D LEFE CRG		RISA-2D LEFE Bowles		RISA-2D LEFE UCS/SPT		RISA-2D LEFE TCP		RISA-2D LEFE DCP		RISA-2D LEFE PMT		RISA-2D LEFE FWD	
	TL		RLL		TL		RLL			TL		RLL			max	min	max	min	max	min	max	min	max	min	max	min	max	min
	max	min	max	min	max	min	max	min	max	min	max	min	max	min	max	min	max	min	max	min	max	min	max	min	max	min	max	min
WBEC	1.7	4.4	5.0	3.8	2.5	4.6	3.7	4.3	4.1	5.2	5.2	4.9	4.9	2.7	6.6	3.1	14.0	3.6	11.4	3.3	14.9	3.5	14.2	5.3	8.7	3.3		
WEM	74.6	5.3	37.1	6.5	43.9	2.7	7.0	3.9	41.8	2.7	4.6	3.9	38.6	1.7	39.1	1.9	23.4	1.6	24.2	1.5	22.7	1.0	49.1	2.8	32.7	1.8		
WTEC	0.2	1.1	0.4	1.0	0.7	0.5	0.8	0.5	0.8	0.5	0.9	0.5	0.4	0.5	0.6	0.6	0.9	0.7	0.8	0.7	1.0	0.7	1.3	0.7	0.7	0.6		
TEC	0.7	33.7	0.4	31.8	1.3	10.1	1.6	8.4	1.7	11.0	2.0	9.4	0.9	11.0	1.1	11.8	2.0	16.7	1.7	15.0	2.2	17.3	2.8	16.0	1.4	13.2		
TEM	14.9	1.7	15.1	1.6	6.0	0.9	6.2	0.7	6.0	0.9	6.2	0.7	4.9	0.7	5.0	0.7	4.8	0.7	4.7	0.7	4.1	0.7	5.5	0.8	5.0	0.7		
TIC1	11.3	4.3	4.3	4.3	0.6	1.9	0.5	2.0	0.8	2.2	0.7	2.3	0.2	1.4	0.6	1.5	2.1	1.5	1.4	2.4	1.4	2.3	2.2	1.0	1.5			
WBIC1	7.3	3.0	7.4	2.9	3.2	1.0	3.2	1.0	4.7	1.3	4.8	1.2	4.2	1.7	5.3	2.0	10.5	3.3	8.5	2.8	11.9	3.6	12.5	4.3	6.6	2.4		
WIM1	6.0	4.2	6.1	4.1	2.7	1.6	2.8	1.5	2.7	1.6	2.8	1.5	1.8	1.3	1.9	1.3	1.8	1.2	1.8	1.2	1.5	1.1	2.2	1.2	1.9	1.3		
WTIC1	2.2	3.2	2.2	3.1	1.7	2.5	1.8	2.4	1.9	2.9	2.0	2.8	1.7	2.4	1.9	2.7	2.3	3.9	2.1	3.4	2.3	4.2	2.9	4.5	2.0	3.0		
BEC	7.6	20.1	12.2	18.6	5.0	12.0	8.9	10.6	8.8	14.2	12.7	12.9	11.1	8.1	15.1	9.5	31.3	11.2	25.4	10.3	34.3	11.2	31.9	16.9	19.4	10.1		
BEM	24.8	30.1	25.4	26.4	15.1	4.8	15.6	1.2	15.7	5.1	16.3	1.4	5.8	0.5	15.1	10.0	5.7	4.2	5.6	2.9	4.9	5.2	9.1	8.3	6.2	1.7		
BIC1	4686.7	16.1	3729.6	16.4	2980.0	8.4	2370.0	8.5	5030.0	9.4	4520.0	9.6	3660.0	7.8	5120.0	8.8	9080.0	11.5	7440.0	10.5	9300.0	11.3	14360.0	12.7	6340.0	9.6		
TIC2	14.9	8.4	14.9	8.5	6.8	4.7	6.8	4.8	7.0	5.2	6.9	5.3	4.9	3.2	5.1	3.4	5.2	3.1	5.0	3.0	4.6	2.3	5.7	4.5	5.1	3.3		
TIM1	32.8	19.9	33.8	19.8	22.4	6.8	22.8	6.7	37.4	7.1	37.7	7.1	5.9	6.1	10.1	6.5	43.0	7.0	31.4	6.6	50.0	6.6	59.2	7.6	19.7	6.6		
WBIC2	8.9	9.9	8.9	9.9	4.2	3.5	4.2	3.5	5.7	4.6	5.7	4.6	3.7	3.9	4.6	4.9	8.5	8.7	7.0	7.3	9.6	9.7	9.9	9.6	5.6	5.9		
WIM2	13.1	13.5	13.1	13.5	4.5	6.1	4.5	6.1	4.5	6.0	4.4	6.1	3.7	5.0	3.8	5.1	3.6	4.0	4.9	3.7	4.9	3.3	4.4	3.8	5.2	3.8	5.1	
WTIC2	4.8	1.7	4.8	1.7	4.3	6.0	4.2	6.1	4.7	7.0	4.7	7.0	4.0	5.0	4.5	5.5	5.8	7.8	5.2	6.9	6.1	8.1	6.3	8.9	4.8	6.1		
BIC2	16.3	15.5	15.1	15.7	12.9	9.3	12.0	9.5	19.7	10.3	18.7	10.5	12.0	8.4	16.2	9.4	31.7	11.4	26.0	10.6	34.4	11.2	38.0	12.6	20.6	10.1		
BIM1	26220.0	10.5	26110.0	10.7	7130.0	0.2	7110.0	0.3	6580.0	0.6	6530.0	0.7	4940.0	0.0	4910.0	0.0	3240.0	60.0	3970.0	30.0	3200.0	150.0	4470.0	0.0	4600.0	0.0		
BIC3	33.5	54.6	34.3	54.3	31.1	31.1	13.2	31.0	18.3	35.3	18.7	35.2	14.1	27.8	18.7	31.2	33.4	40.4	28.1	37.0	35.3	40.6	38.6	45.3	23.2	34.0		
TIC4					6.7	9.9	6.8	9.9	9.6	10.9	9.8	10.9	1.3	8.5	3.2	8.9	12.5	10.1	9.3	9.5	14.4	9.5	16.3	11.6	6.0	9.2		
TIM2					4.7	3.2	4.7	3.2	4.8	3.4	4.8	3.3	4.1	2.7	4.2	2.8	4.3	2.5	4.2	2.6	3.9	1.8	4.8	2.9	4.3	2.8		
BIC4					13.7	16.1	13.9	16.0	19.2	18.2	19.4	18.1	10.3	13.8	14.1	15.4	25.9	19.2	21.5	17.9	27.2	19.0	31.4	21.1	17.6	16.7		
BIM2					88.4	1.1	88.5	1.5	81.2	1.6	81.6	2.3	61.3	0.0	61.0	0.1	39.3	2.4	48.9	1.3	34.8	4.4	50.8	0.9	57.0	0.5		

TABLE 6.10. OPERATING RATING PROBLEM CRITICAL SECTIONS FOR TULIA CULVERT: 1.5' OF FILL

	CULV-5				RISA-2D TEXT					RISA-2D STRUC					RISA-2D LEFE CRG		RISA-2D LEFE Bowles		RISA-2D LEFE UCS/SPT		RISA-2D LEFE TCP		RISA-2D LEFE DCP		RISA-2D LEFE PMT		RISA-2D LEFE FWD	
	TL		RLL		TL		RLL			TL		RLL			max	min	max	min	max	min	max	min	max	min	max	min	max	min
	max	min	max	min	max	min	max	min	max	min	max	min	max	min	max	min	max	min	max	min	max	min	max	min	max	min	max	min
WBEC	18.44	0.19	5.24	0.46	10.17	0.42	6.52	0.50	10.12	0.38	7.59	0.50	9.85	0.22	7.62	0.01	4.40	0.61	5.06	0.40	4.35	0.80	4.43	0.46	6.16	0.16		
WEM	0.59	1.41	2.45	0.93	1.01	2.79	12.97	1.58	1.10	2.85	20.15	1.58	2.09	3.82	2.13	3.41	2.98	4.62	3.00	4.62	2.92	7.33	1.89	2.27	2.45	3.80		
WTEC	11.55	0.27	4.05	0.43	2.40	0.94	1.93	1.15	3.18	0.99	2.72	1.15	5.04	1.34	3.55	1.40	1.33	1.57	1.96	1.49	0.95	1.75	0.81	1.77	2.72	1.43		
TEC	2.97	0.34	6.75	0.43	5.77	1.62	4.41	2.19	4.60	1.57	3.68	2.19	7.75	2.13	5.56	2.16	2.37	2.02	3.22	2.02	1.85	2.13	1.50	2.28	4.33	2.08		
TEM	0.73	2.29	0.71	2.67	1.82	4.58	1.73	5.96	1.89	7.81	1.80	5.96	2.34	9.86	2.27	9.55	2.36	10.32	2.41	10.28	2.76	10.42	2.03	8.66	2.30	9.71		
TIC1	4.79	0.56	4.02	0.53	9.38	1.40	12.56	1.32	6.93	1.28	8.44	1.32	28.14	1.76	13.03	1.50	4.30	0.98	5.32	1.24	3.90	0.97	4.06	0.53	7.70	1.37		
WBIC1	0.92	0.99	0.87	1.04	2.18	2.69	2.16	2.84	1.57	2.15	1.54	2.84	2.23	1.18	1.99	0.73	1.62	0.40	1.69	0.06	1.66	0.68	1.57	0.55	1.81	0.35		
WIM1	0.84	0.93	0.80	0.98	1.85	2.46	1.73	2.66	1.87	2.55	1.74	2.66	2.70	3.36	2.55	3.33	2.69	3.52	2.73	3.50	3.03	3.87	2.23	3.42	2.59	3.37		
WTIC1	0.62	0.60	0.59	0.63	0.73	0.81	0.68	0.88	0.65	0.75	0.60	0.88	0.46	1.18	0.27	1.19	0.34	1.30	0.12	1.26	0.60	1.42	0.44	1.30	0.11	1.20		
BEC	10.10	0.81	5.80	0.99	13.19	1.67	6.78	2.04	7.73	1.47	4.92	2.04	6.95	2.20	5.52	1.67	3.46	0.66	3.90	1.03	3.42	0.40	3.42	0.43	4.60	1.36		
BEM	0.62	3.19	0.57	3.81	1.03	20.12	0.95	86.18	1.00	31.19	0.92	86.18	2.41	372.44	2.01	172.60	2.14	42.36	2.18	62.07	2.47	34.20	1.35	21.28	2.02	103.00		
BIC1	8.82	0.62	11.42	0.58	10.80	1.64	13.78	1.58	6.47	1.54	7.32	1.58	7.94	2.05	5.41	1.88	2.18	1.71	3.11	1.75	1.90	1.82	1.18	1.64	4.09	1.79		
TIC2	8.07	0.58	7.04	0.57	5.55	2.09	5.96	2.03	5.07	2.03	5.41	2.03	29.67	2.26	21.20	2.15	3.57	2.08	5.12	2.13	2.60	2.31	3.32	1.77	9.31	2.08		
TIM1	0.76	1.74	0.76	1.71	1.66	3.11	1.67	3.00	1.71	4.80	1.72	3.00	2.45	7.67	2.39	7.18	2.44	7.45	2.48	7.63	2.80	9.23	2.20	5.12	2.40	7.25		
TIC3	4.57	0.59	4.40	0.60	5.71	2.05	5.60	2.06	3.49	2.04	3.46	2.06	22.61	2.33	13.59	2.16	3.72	1.70	4.76	1.94	3.34	1.69	2.94	1.38	7.23	2.05		
WBIC2	0.69	0.70	0.69	0.70	1.47	2.01	1.47	2.02	1.12	1.56	1.13	2.02	1.81	1.72	1.53	1.32	1.06	0.48	1.15	0.71	1.05	0.30	1.00	0.32	1.31	1.01		
WIM2	0.88	1.13	0.88	1.13	2.58	2.50	2.61	2.47	2.65	2.59	2.69	2.47	3.21	3.09	3.14	3.02	3.25	3.16	3.25	3.15	3.57	3.55	3.10	2.98	3.16	3.04		
WTIC2	0.71	2.37	0.71	2.37	0.80	0.67	0.80	0.67	0.73	0.60	0.73	0.67	0.82	0.88	0.70	0.83	0.34	0.77	0.48	0.78	0.22	0.83	0.24	0.73	0.60	0.79		
BIC2	6.28	0.72	6.88	0.70	6.31	1.61	6.94	1.55	4.25	1.52	4.57	1.55	7.13	1.82	5.47	1.58	3.24	1.08	3.73	1.25	3.24	0.96	2.86	0.89	4.46	1.41		
BIM1	0.67	2.15	0.67	2.10	2.56	130.08	2.57	67.38	2.80	62.65	2.83	67.38	3.79	NA	3.66	NA	46.69	253.45	4.09	540.89	4.45	94.98	3.22	NA	3.74	NA		
BIC3	3.82	0.68	3.70	0.69	1.59	1.59	7.66	1.60	5.65	1.47	5.52	1.60	60.96	1.97	5.18	1.77	2.53	1.51	3.22	1.57	2.20	1.58	2.04	1.40	4.08	1.65		
TIC4					6.06	1.90	5.94	1.90	4.29	1.83	4.22	1.90	30.77	2.34	13.23	2.21	3.40	1.92	4.53	2.06	2.90	2.08	2.72	1.62	7.02	2.15		
TIM2					2.01	4.29	2.01	4.32	2.06	7.04	2.05	4.32	2.42	8.52														

## 10. Deflections

Deflection data were collected as a backup measure. Figure 6.36 shows the measured deflection in the culvert at the midspans.

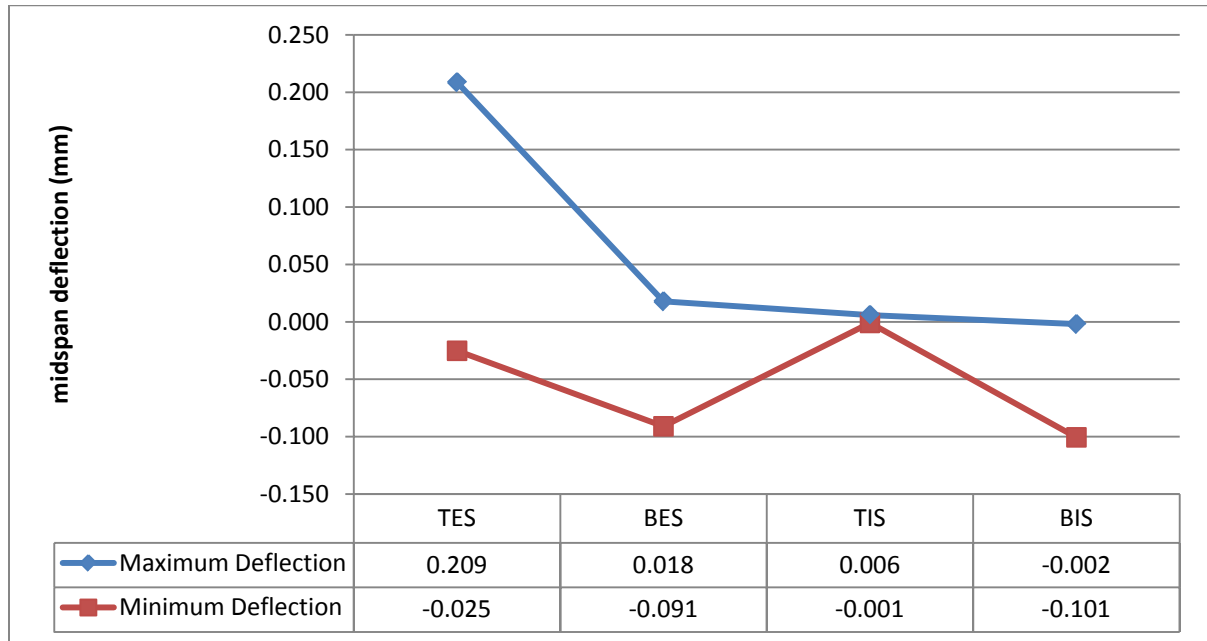

FIGURE 6.36. MEASURED DEFLECTIONS IN MILLIMETERS FOR THE TULIA CULVERT: 1.5' OF FILL

## 11. Summary of Findings for the Tulia Culvert

From this case study the following findings are noted:

1. Predicted sign for live load moment corresponds to actual moment sign indicating excellent agreement between reality and the models except for the top slab corners in CULV-5.
2. Predicted magnitude for live load moment typically higher than actual moment magnitude and therefore conservative.
3. Scatter for predicted dead load moment is slightly higher than for predicted live load moment (stdev = 0.38/0.31).
4. Critical sections for live load are not the same as critical sections for Operating Rating except for the exterior wall top corner for CULV-5 and RISA-2D with springs, and this location is not the controlling location.
5. CULV-5 yields most conservative moments and among the worst Operating Rating.
6. RISA-LEFE ( $E_s$  per *Culvert Rating Guide*) yields least conservative moments and highest Operating Rating.

## 7. LIMITED DEAD LOAD INVESTIGATION

The standard deviation for dead load as determined by the various models is much higher than for live load. In the case studies the live load was investigated at length and has been found to almost always predict the appropriate bending direction and usually predict a conservative magnitude for moment. However, because the instrumentation and load testing was done using in-service culverts, no consistent or truly comparative measure of the dead load could be made.

### 1. Dead Load Moment – Predicted and Measured

One data point dealing with dead load exists. Instrumentation was able to measure the change in dead load when additional fill was added to the Shallowater culvert to increase the fill thickness from two feet to four feet. The change in moment was predicted using the various models. These results are compared in Figure 6.37. The dark blue line shows the measured moment.

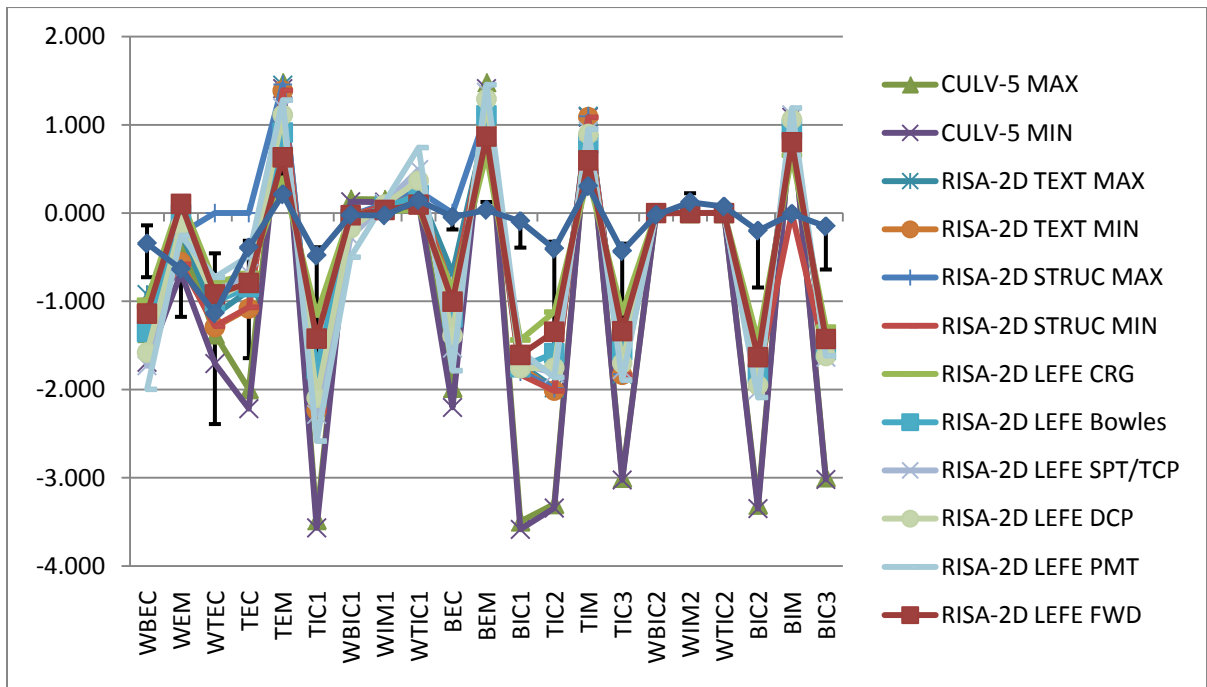

FIGURE 6.37. THE CHANGE IN DEAD LOAD MOMENT, PREDICTED AND MEASURED, FOR THE SHALLOWATER CULVERT FROM 2' TO 4' OF FILL.

## 2. Dead Load “Goodness”

For all but the exterior wall corner and the center wall, the measure dead load moments are much smaller than the predicted values. Figure 6.38 shows the dead load goodness.

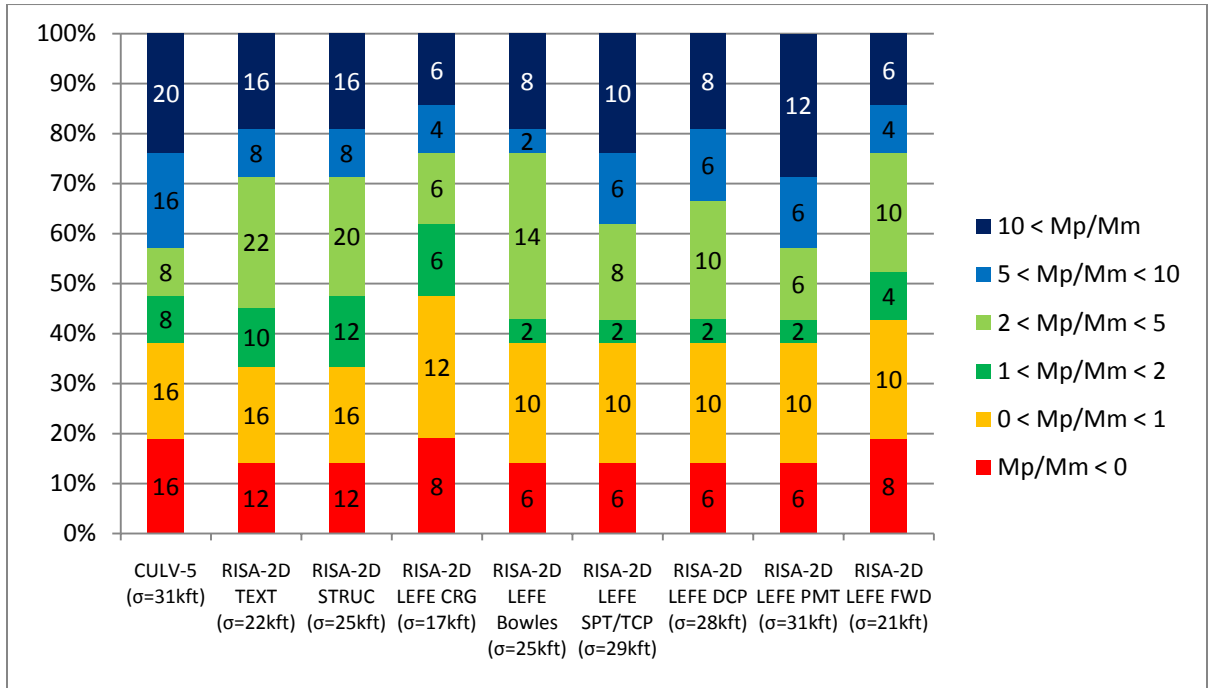

FIGURE 6.38. CHANGE IN DEAD LOAD GOODNESS FOR THE SHALLOWATER CULVERT FROM 2' TO 4' OF FILL.

Amazingly, the dead load seems to be model with approximately the same degree of inaccuracy by all models. Across the models, about 15% of the critical sections are not predicted in the correct direction. For all but the *Culvert Rating Guide* version of RISA-2D with LEFE about 25% of the critical sections do not predict adequate magnitude. The RISA-2D with LEFE using the soil modulus from the *Culvert Rating Guide* shows that nearly 50% of the critical sections are unconservatively modeled. However, based on the standard deviation of the difference between measured and predicted, the *Culvert Rating Guide* produces the best moment shape compared to the measure moment envelope.

## 3. Critical Section Analysis

Table 6.11 shows that the problem critical sections for dead load prediction are actually very uniform across the models. The wall midspans, the top slab interior corner, and the centermost bottom midspans all have trouble. Table 6.12 shows the combined problem critical sections for the operating ratings at both two feet of fill and four feet of fill. A close examination of these two tables shows some overlap but no overlapped critical section controls the load ratings.

**TABLE 6.11. LIVE LOAD DEMAND PROBLEM CRITICAL SECTIONS FOR THE CHANGE IN DEAD LOAD IN THE SHALLOW WATER CULVERT FROM 2' TO 4' OF FILL**

	CULV-5				RISA-2D TEXT				RISA-2D STRUC				RISA-2D LEFE CRG		RISA-2D LEFE Bowles		RISA-2D LEFE SPT/TCP		RISA-2D LEFE DCP		RISA-2D LEFE PMT		RISA-2D LEFE FWD	
	TL		RLL		TL		RLL		TL		RLL		max	min	max	min	max	min	max	min	max	min	max	min
WBEC	4.9	3.9	4.9	3.9	3.1	2.7	3.1	2.7	3.2	2.8	3.2	2.8	2.9	2.9	3.9	3.9	5.0	5.0	4.6	4.6	5.8	5.8	3.3	3.3
WEM	0.5	1.1	0.5	1.1	0.3	0.9	0.3	0.9	0.4	0.9	0.4	0.9	-0.3	-0.3	0.0	0.0	0.3	0.3	0.2	0.2	0.4	0.4	-0.2	-0.2
WTEC	1.5	1.2	1.5	1.2	1.1	1.0	1.1	1.0	1.1	1.0	1.1	1.0	0.7	0.7	0.9	0.9	0.8	0.8	0.9	0.9	0.6	0.6	0.8	0.8
TEC	5.7	5.1	5.7	5.1	2.8	2.2	2.8	2.2	2.7	2.2	2.7	2.2	1.8	1.8	2.1	2.1	1.7	1.7	2.0	2.0	1.2	1.2	2.0	2.0
TEM	6.7	7.0	6.7	7.0	6.6	6.9	6.6	6.9	6.6	6.9	6.6	6.9	1.9	1.9	4.3	4.3	5.7	5.7	5.3	5.3	6.1	6.1	3.0	3.0
TIC1	34789.4	35380.0	34789.4	35380.0	21380.0	22380.0	21380.0	22380.0	21380.0	22380.0	21380.0	22380.0	18380.0	19380.0	17380.0	17380.0	22380.0	22380.0	21380.0	22380.0	25380.0	25380.0	14380.0	14380.0
WBIC1	-5.6	-6.9	-5.6	-6.9	1.7	2.1	1.7	2.1	1.3	1.5	1.3	1.5	0.4	0.4	3.0	3.0	11.9	11.9	7.5	7.5	21.8	21.8	1.0	1.0
WIM1	-4.5	-5.6	-4.5	-5.6	2.4	3.6	2.4	3.6	3.1	3.9	3.1	3.9	-0.6	-0.6	2.5	2.5	4.0	4.0	3.6	3.6	4.4	4.4	-1.1	-1.1
WTIC1	0.8	1.0	0.8	1.0	1.4	1.7	1.4	1.7	1.4	1.7	1.4	1.7	0.3	0.3	1.4	1.4	3.4	3.4	2.6	2.6	5.2	5.2	0.7	0.7
BEC	50.0	44.9	50.0	44.9	20.3	15.6	20.3	15.6	21.5	16.9	21.5	16.9	19.8	19.8	26.8	26.8	34.7	34.7	31.5	31.5	40.5	40.5	22.8	22.8
BEM	41.2	43.2	41.2	43.2	29.0	29.9	29.0	29.9	31.8	32.9	31.8	32.9	19.6	19.6	32.3	32.3	40.0	40.0	37.7	37.7	42.5	42.5	25.3	25.3
BIC1	37.5	38.5	37.5	38.5	18.4	18.7	18.4	18.7	19.3	19.7	19.3	19.7	15.4	15.4	18.8	18.8	18.4	18.4	18.9	18.9	16.8	16.8	17.3	17.3
TIC2	8.1	8.3	8.1	8.3	4.9	5.0	4.9	5.0	4.9	5.0	4.9	5.0	2.8	2.8	3.9	3.9	4.5	4.5	4.3	4.3	4.6	4.6	3.3	3.3
TIM1	3.6	3.6	3.6	3.6	3.6	3.6	3.6	3.6	3.6	3.6	3.6	3.6	1.3	1.3	2.6	2.6	3.1	3.1	3.0	3.0	3.1	3.1	2.0	2.0
TIC3	7.0	6.9	7.0	6.9	4.2	4.2	4.2	4.2	4.2	4.2	4.2	4.2	2.6	2.6	3.6	3.6	4.1	4.1	3.9	3.9	4.4	4.4	3.1	3.1
WBIC2	0.0	0.0	0.0	0.0	0.1	0.0	0.1	0.0	0.1	0.0	0.1	0.0	0.0	0.0	0.0	0.0	0.0	0.0	0.0	0.0	0.0	0.0	0.0	0.0
WIM2	0.0	0.0	0.0	0.0	0.0	0.0	0.0	0.0	0.0	0.0	0.0	0.0	0.0	0.0	0.0	0.0	0.0	0.0	0.0	0.0	0.0	0.0	0.0	0.0
WTIC2	0.0	0.0	0.0	0.0	0.0	0.0	0.0	0.0	0.0	0.0	0.0	0.0	0.0	0.0	0.0	0.0	0.0	0.0	0.0	0.0	0.0	0.0	0.0	0.0
BIC2	16.5	16.7	16.5	16.7	8.7	8.9	8.7	8.9	9.1	9.3	9.1	9.3	7.2	7.2	9.1	9.1	10.0	10.0	9.7	9.7	10.4	10.4	8.1	8.1
BIM1	-111.6	-110.6	-111.6	-110.6	-92.4	-92.7	-92.4	-92.7	-98.9	-99.1	-98.9	-99.1	-66.8	-66.8	-97.5	-97.5	-113.4	-113.4	-108.3	-108.3	-121.3	-121.3	-81.9	-81.9
BIC3	19.8	19.7	19.8	19.7	10.4	10.3	10.4	10.3	10.7	10.6	10.7	10.6	8.5	8.5	10.2	10.2	10.7	10.7	10.6	10.6	10.6	10.6	9.4	9.4

**TABLE 6.12. OPERATING RATING PROBLEM CRITICAL SECTIONS FOR THE CHANGE IN DEAD LOAD IN THE SHALLOWATER CULVERT FROM 2' TO 4' OF FILL**

	Operating Ratings Under 2' of Fill																							
	CULV-5				RISA-2D TEXT				RISA-2D STRUC				RISA-2D LEFE CRG		RISA-2D LEFE Bowles		RISA-2D LEFE SPT/TCP		RISA-2D LEFE DCP		RISA-2D LEFE PMT		RISA-2D LEFE FWD	
	TL		RLL		TL		RLL		TL		RLL		max	min	max	min	max	min	max	min	max	min	max	min
	max	min	max	min	max	min	max	min	max	min	max	min	max	min	max	min	max	min	max	min	max	min	max	min
WBEC	26.12	0.05	5.41	0.47	14.94	0.65	7.21	0.88	14.35	0.65	7.22	0.88	15.65	0.75	7.36	-0.39	4.82	-0.96	5.46	-0.79	4.19	-1.18	11.12	0.18
WEM	0.67	1.88	3.19	1.17	0.91	3.16	9.84	1.78	0.97	3.16	10.75	1.78	3.90	13.17	3.50	4.64	3.74	3.15	3.67	3.50	3.80	2.83	3.51	7.49
WTEC	11.22	0.26	3.54	0.51	7.62	0.68	4.32	0.86	6.44	0.68	3.83	0.86	5.35	1.27	1.20	1.51	-0.38	1.88	0.06	1.75	-0.87	2.06	3.13	1.33
TEC	41.47	0.07	10.17	0.18	13.34	0.71	5.73	1.02	10.88	0.71	5.14	1.02	8.61	1.35	2.45	1.69	0.25	2.05	0.84	1.93	-0.38	2.20	5.27	1.45
TEM	0.20	3.21	0.17	3.79	0.33	5.22	0.28	6.61	0.34	5.22	0.29	6.61	0.64	10.37	0.43	9.14	0.36	8.65	0.38	8.79	0.34	8.50	0.53	9.66
TIC1	13.50	0.24	20.26	0.21	9.86	0.92	13.91	0.83	9.45	0.92	12.96	0.83	52.93	1.36	16.95	0.70	7.11	0.06	9.61	0.29	5.34	-0.28	33.09	1.06
WBIC1	0.94	1.16	0.87	1.25	1.65	3.59	1.66	3.47	1.64	3.59	1.64	3.47	2.91	2.10	2.48	0.78	2.19	-0.60	2.27	-0.13	2.12	-1.17	2.71	1.59
WIM1	0.83	1.04	0.78	1.11	1.73	2.27	1.62	2.43	1.68	2.27	1.57	2.43	3.14	3.54	2.29	3.01	2.00	2.89	2.06	2.91	1.95	2.88	2.69	3.23
WTIC1	0.60	0.70	0.57	0.74	0.78	0.82	0.70	0.90	0.79	0.82	0.71	0.90	0.74	1.27	0.18	1.32	-0.45	1.50	-0.21	1.44	-0.81	1.60	0.52	1.25
BEC	15.05	-0.12	7.92	0.03	44.77	0.70	11.50	1.25	38.11	0.70	11.34	1.25	20.95	0.72	9.03	-0.48	5.65	-1.06	6.49	-0.88	4.82	-1.29	14.17	0.10
BEM	0.41	4.11	0.35	4.94	1.08	21.49	1.00	53.56	0.93	21.49	0.85	53.56	4.23	524.94	1.33	122.09	0.65	47.47	0.79	64.01	0.55	32.15	2.52	308.44
BIC1	13.86	0.08	18.94	0.04	22.89	1.31	38.88	1.25	23.95	1.31	41.30	1.25	39.88	1.92	11.54	1.38	4.11	1.34	5.94	1.33	2.29	1.38	23.41	1.60
TIC2	7.05	0.24	7.82	0.23	8.99	0.97	10.36	0.93	8.12	0.97	9.19	0.93	56.46	1.60	22.74	1.27	6.86	1.19	10.91	1.22	4.27	1.18	37.86	1.43
TIM1	0.24	1.75	0.25	1.72	0.38	4.59	0.39	4.43	0.39	4.59	0.40	4.43	0.70	9.01	0.56	7.82	0.56	6.47	0.56	6.94	0.59	5.65	0.61	8.51
TIC3	3.61	0.29	3.49	0.30	4.77	1.10	4.58	1.12	4.52	1.10	4.35	1.12	44.49	1.66	13.61	1.33	5.61	0.98	7.74	1.13	4.16	0.72	23.58	1.50
WBIC2	0.94	0.90	0.94	0.90	2.15	2.15	2.18	2.18	2.13	2.15	2.20	2.18	2.42	2.42	1.62	1.62	1.04	1.04	1.22	1.22	0.85	0.85	2.08	2.08
WIM2	0.90	0.83	0.90	0.83	2.29	2.29	2.28	2.28	2.31	2.29	2.29	2.28	3.41	3.41	2.80	2.80	2.63	2.63	2.67	2.67	2.58	2.58	3.07	3.07
WTIC2	0.63	0.59	0.63	0.59	0.78	0.78	0.79	0.79	0.78	0.78	0.79	0.79	1.01	1.01	0.76	0.76	0.63	0.63	0.67	0.67	0.56	0.56	0.89	0.89
BIC2	8.33	0.09	9.15	0.08	10.42	1.31	12.00	1.24	10.40	1.31	11.94	1.24	20.60	1.73	8.76	0.97	5.25	0.58	6.11	0.70	4.41	0.39	13.91	1.34
BIM1	0.50	2.50	0.51	2.45	2.75	9.22	2.72	8.97	2.54	9.22	2.52	8.97	4.95	NA	2.80	NA	2.17	NA	2.36	NA	1.63	587.61	3.71	NA
BIC3	5.38	0.13	5.19	0.14	11.63	1.31	10.95	1.33	11.73	1.31	11.04	1.33	20.95	1.88	8.28	1.24	4.40	1.05	5.39	1.09	3.36	1.03	13.92	1.53
	Operating Ratings Under 4' of Fill																							
	CULV-5				RISA-2D TEXT				RISA-2D STRUC				RISA-2D LEFE CRG		RISA-2D LEFE Bowles		RISA-2D LEFE SPT/TCP		RISA-2D LEFE DCP		RISA-2D LEFE PMT		RISA-2D LEFE FWD	
	TL		RLL		TL		RLL		TL		RLL		max	min	max	min	max	min	max	min	max	min	max	min
	max	min	max	min	max	min	max	min	max	min	max	min	max	min	max	min	max	min	max	min	max	min	max	min
WBEC	-7.00	-0.61	13.77	0.03	384.38	0.76	18.55	1.69	174.02	0.76	18.36	1.69	32.87	0.12	13.58	-1.43	8.23	-2.17	9.53	-1.95	6.95	-2.45	21.83	-0.68
WEM	1.15	3.87	7.46	1.74	1.28	10.61	25.31	3.17	1.37	10.61	26.87	3.17	5.74	24.29	5.96	7.30	6.88	4.50	6.62	5.14	7.14	3.91	5.49	12.88
WTEC	-1.99	-0.10	10.34	0.41	5.50	0.65	174.45	1.09	6.31	0.65	165.41	1.09	15.72	1.95	3.85	1.99	0.13	2.44	1.11	2.25	-0.93	2.68	9.13	1.85
TEC	89.97	-0.42	15.04	-0.22	3.40	0.73	213.50	1.58	3.85	0.73	212.11	1.58	20.44	2.18	5.35	2.28	0.92	2.74	2.07	2.57	-0.29	2.95	11.88	2.12
TEM	0.00	7.20	-0.08	9.23	0.03	12.58	-0.09	19.02	0.05	12.58	-0.08	19.02	1.03	40.92	0.31	22.91	0.10	18.21	0.15	19.43	0.04	16.98	0.61	30.20
TIC1	21.90	-0.25	34.65	-0.31	45.03	0.86	145.33	0.65	46.55	0.86	157.56	0.65	128.50	1.78	105.08	0.28	17.42	-0.80	29.46	-0.44	11.20	-1.31	151.01	1.08
WBIC1	1.60	2.18	1.44	2.41	4.16	11.25	4.18	10.11	4.14	11.25	4.08	10.11	5.49	4.05	3.76	1.13	3.22	-1.04	3.34	-0.33	3.12	-1.92	4.55	2.72
WIM1	1.39	1.88	1.26	2.07	3.37	4.60	3.01	5.20	3.24	4.60	2.89	5.20	6.78	7.74	3.88	5.45	3.03	4.90	3.23	5.02	2.87	4.82	5.18	6.42
WTIC1	1.09	1.42	1.00	1.54	1.71	1.81	1.41	2.09	1.71	1.81	1.41	2.09	1.50	2.65	0.18	2.26	-0.86	2.38	-0.49	2.31	-1.42	2.49	0.89	2.38
BEC	100.85	-0.83	18.44	-0.62	5.77	0.73	26.24	3.17	6.47	0.73	25.24	3.17	39.37	0.05	15.38	-1.55	9.12	-2.29	10.65	-2.06	7.61	-2.57	25.65	-0.78
BEM	0.20	8.82	0.08	11.59	1.30	29.73	1.11	109.59	1.02	29.73	0.83	109.59	4.33	770.64	0.44	183.35	-0.47	80.18	-0.27	103.64	-0.60	54.82	2.04	436.46
BIC1	29.14	-0.56	48.78	-0.62	41.61	1.22	102.98	1.10	43.29	1.22	108.82	1.10	99.98	2.03	25.15	1.30	8.43	1.38	12.26	1.31	4.76	1.53	58.13	1.57
TIC2	14.13	-0.19	16.21	-0.23	66.28	1.03	174.34	0.93	64.09	1.03	155.38	0.93	89.80	2.25	38.68	1.29	19.46	1.05	24.65	1.09	11.71	1.04	63.60	1.71
TIM1	0.16	4.22	0.18	4.11	0.30	15.59	0.33	14.58	0.33	15.59	0.36	14.58	1.14	38.48	0.57	19.07	0.50	12.88	0.50	14.61	0.53	10.72	0.79	27.32
TIC3	9.63	-0.10	9.13	-0.08	52.77	1.25	43.89	1.29	46.84	1.25	39.52	1.29	82.51	2.38	49.21	1.38	14.37	0.70	25.52	0.96	8.98	0.27	64.20	1.85
WBIC2	1.81	1.73	1.81	1.73	4.56	4.55	4.62	4.61	4.72	4.55	4.76	4.61	4.55	4.55	2.43	2.43	1.46	1.46	1.73	1.73	1.17	1.17	3.47	3.47
WIM2	1.56	1.51	1.56	1.51	4.74	4.74	4.69	4.69	4.73	4.74	4.69	4.69	7.41	7.41	4.92	4.92	4.25	4.25	4.41	4.40	4.13	4.12	5.98	5.98
WTIC2	1.21	1.20	1.21	1.20	1.76	1.76	1.77	1.77	1.73	1.76	1.74	1.77	2.04	2.04	1.25	1.25	0.92	0.92	1.01	1.01	0.80	0.80	1.62	1.62
BIC2	19.45	-0.49	22.76	-0.52	24.52	1.20	31.77	1.07	24.40	1.20	31.33	1.07	47.73	1.75	17.55	0.67	9.70	0.17	11.58	0.33	7.83	-0.07	30.16	1.18
BIM1	0.43	5.40	0.45	5.25	2.83	25.27	2.78	23.89	2.47	25.27	2.45	23.89	5.36	NA	2.32	NA	1.02	545.22	1.49	NA	-0.03	-4.93	3.62	NA
BIC3	13.40	-0.39	12.63	-0.37	31.15	1.32	27.57	1.36	31.32	1.32	27.67	1.36	47.44	2.05	16.67	1.17	8.28	0.98	10.37	1.01	6.18	0.99	30.01	1.55

#### 4. Deflections

Figure 6.39 shows the deflections. Because the moment measurement at the critical sections was so successful, no further analysis was made of the dead load deflections. It is worth noting that the dead load deflections are nearly an order of magnitude smaller than the live load deflections.

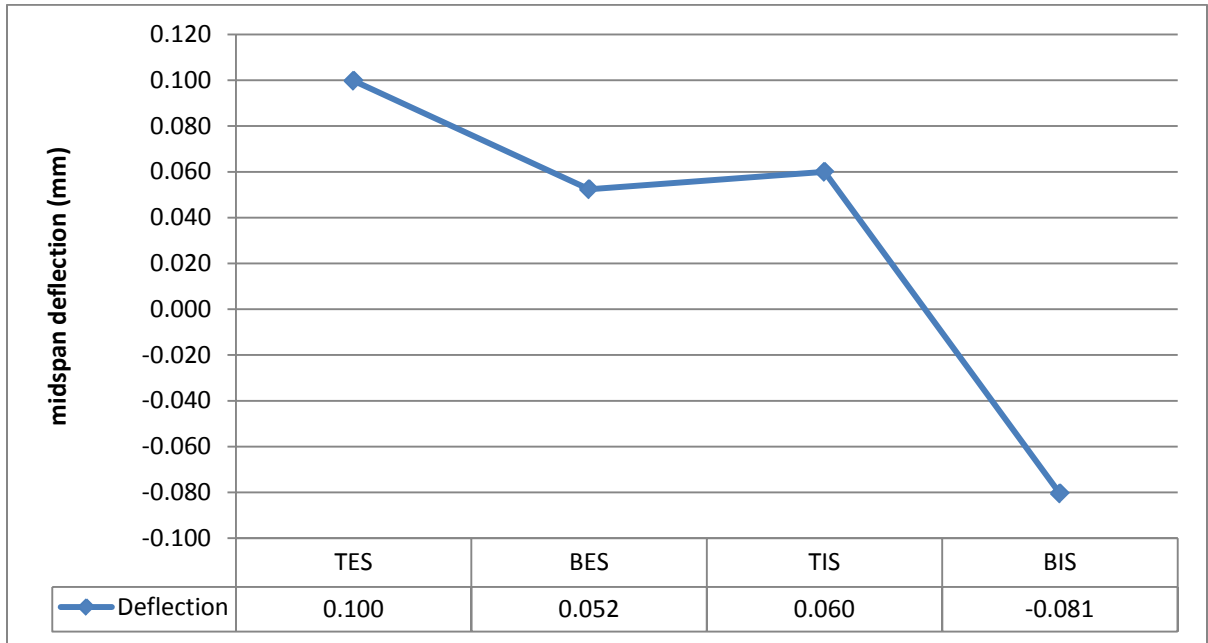

FIGURE 6.39. MEASURED DEFLECTIONS IN MILLIMETERS FOR THE SHALLOW WATER CULVERT FROM 2' TO 4' OF FILL



## 5. Summary of Findings for the Limited Dead Load Investigation

The summary of the limited dead load investigation are as follows:

1. For the one case, sign for predicted live load moment does NOT correspond to sign for actual moment for 10-20% of the critical sections
2. For the one case, predicted magnitude for dead load moment is higher than actual moment magnitude for ~60% of the critical sections
3. Some overlap occurs between Operating Rating problem critical sections and Dead Load ratio problem critical sections, though none of these sections are the controlling critical sections.
  1. CULV-5 has problems in the interior walls, TIC1 and BIM.
  2. RISA-2D with Springs has problems at WEM, TIC1, and WTIC2
  3. RISA-2D with LEFE is dependent on the modulus of elasticity:
    1. For the *Culvert Rating Guide* value, only the WTIC1 has a problem. The *Culvert Rating Guide* is the best model for dead load.
    2. For the textbook value, TIC1 and WTIC2 have problems.
    3. For the SPT, TCP and DCP values, WTEC, TIC1, and WTIC2 have problems.
    4. For the pressuremeter values, WTEC, TIC1, WBIC2, WTIC2 and BIM have problems.
    5. For the FWD values, the top wall interior corners have problems.
4. Predicted dead load moment is more variable than predicted live load moment and increases with fill depth.

## 8. SUMMARY AND CONCLUSIONS

The field instrumentation portion of this research study was successful in meeting the stated objectives.

The exercise of collecting site specific data was quite illuminating. The limited findings from this study suggest that TxDOT does not use high quality backfill around culverts. Rather, native materials are used to bury reinforced box culverts. It was also illuminating to see the quality of the concrete used in construction. The concrete was stronger, in some cases much stronger, than the values suggested by AASHTO. This suggests that the culvert rating process contains significant conservatism in constructed materials, and is often appropriately conservative in relation to soils.

Measuring the actual strains under known loads confirmed that the models do appropriately predict culvert behavior. Under live loads, the shape of the moment envelope is modeled correctly. The magnitudes of the moments are also conservative, particularly for lower level models.

The process of determining site specific soil testing only highlighted the order of magnitude difficulty associated with obtaining soil parameters for analytical modeling purposes. Though a great many methods are available for determining soil stiffness, many labor-intensive methods produce very conservative results, while the less labor-intensive methods produce results that still produce conservative live load predictions. Soil remains a complex and difficult material to quantify.

The instrumented load tests, by design, did not address several key factors concerning culvert load rating. Most notably the effect of dead load on culvert behavior was not explored. Though some data were available, the ways in which soil acts to support itself and supply load to a buried structure is still not well understood.

The most important conclusion from this portion of the study is that all the *Culvert Rating Guide* analytical methods produce conservative load ratings. Even though the higher order models with less conservative soil values may produce slightly unconservative live load moment predictions in some critical sections, the load rating is always controlled by a conservative, and often over-conservative, critical section demand prediction. Therefore it is safe to say that any presented method is safe for culvert load rating.

However, it is important to note that this is not the case for culvert design. Because demands for some critical sections are under predicted by the higher order models, the higher order models should not be used to design reinforced concrete box culverts. Rather, the faithful, lower-order models, e.g., CULV-5, should continue to be used to design safe, serviceable culverts.

## 7. CONCLUSIONS AND RESEARCH LIMITATIONS

### 1. CONCLUSIONS

#### 1. *Evaluation of TxDOT's Culvert Load Rating Practices and Procedures*

At the beginning of this research study, the assumption was that TxDOT had a repeatable load rating procedure created around CULV-5. However, upon investigation this was not found to be the case. Rather, TxDOT had a definite need for such a procedure. Therefore this project initially focused on articulating a clear and repeatable, production-oriented load rating procedure that would yield reliable load ratings. More sophisticated analyses could conceivably reduce excess overconservatism in the load ratings by considering the effects of soil-structure interaction. To this end the *Culvert Rating Guide* was developed as the project deliverable.

#### 2. *Development of the Culvert Rating Guide*

The *Culvert Rating Guide* is the main deliverable for this project. The guide articulates a clear and repeatable load rating procedure designed to satisfy current AASHTO specifications and provide for four levels of increasing demand modeling sophistication. These four levels are: Level 1, culvert specific frame analysis programs typified by CULV-5; Level 2, two-dimensional general frame analysis programs as typified by RISA-2D with spring subgrade support; Level 3, two-dimensional finite element soil-structure interaction programs as typified by RISA-2D with linear elastic finite elements; and Level 4, higher order generalized programs including non-linear two-dimensional models and three dimensional models. The *Culvert Rating Guide* provides specific direction for load rating using the first three methods.

#### 3. *Evaluation of TxDOT Culvert Designs and Analysis Methods*

Validation of the *Culvert Rating Guide* was accomplished with a breadth and depth approach. In the initial validation task, one hundred TxDOT culvert designs representative of the full population of TxDOT's culvert inventory were load rated using the first three analysis levels. The results showed that in general, the Level 2 analysis produces marginally higher load ratings than the Level 1 analysis. It also showed that the Level 3 method can produce much higher load ratings if the soil is sufficiently stiff. However, if culvert backfill is of poor quality, the higher-level load rating may be less than that determined by CULV-5.

This work also revealed that the presenting problem upon which TxDOT commissioned this research study may in fact be real. That is, for cases where in-service culverts must be lengthened or reconfigured, unless the culvert backfill soil is sufficiently stiff, the culvert may require load posting or replacement. Generally, the newer the culvert is, the more likely that the culvert will load rate acceptably.

#### **4. Parametric Analysis**

The findings of the parametric analysis were incorporated into the *Culvert Rating Guide*. The recommended values for the modulus of subgrade reaction were found to be acceptable. The Level 3 analysis was found to be relatively insensitive to Poisson's ratio and a typical value of 0.3 is appropriate for all but deep fill culverts beneath clay soils. The parametric study also showed that CULV-5 can be used conservatively to load rate culverts with five or more four barrels by modeling the culvert with only four barrels. The load rating is not very sensitive to the lateral earth pressure, therefore AASHTO's equivalent fluid weight values are recommended.

Culvert load ratings were found to be highly sensitive to the modulus of elasticity for the soil in the Level 3 analysis. The depth of fill is also a highly sensitive parameter; therefore, culverts should be load rated at their actual depth of fill and culvert designs should be evaluated at both their maximum and minimum depths.

#### **5. Instrumented Load Tests on Three In-Service Culverts**

Field instrumentation and load tests were limited to three in-service TxDOT culverts, the key objective being a comparison of measured versus predicted live load moment demands. This work primarily evaluated the reliability of analytical modeling approaches recommended in the *Culvert Rating Guide* to predict live load demands.

The instrumented load test data indicated that the culvert load ratings for each model were conservative. The higher level models yielded slightly unconservative results at some critical sections. However, these are not the controlling critical sections for the load rating. Therefore, the most important finding from the field study is that all models may be conservatively used for load rating.

Relative to culvert design, however, only the lowest order model, *i.e.* CULV-5, should be used.

The very limited dead load evaluation indicated that the distribution of moment demands due to dead load is not well understood. An appropriate way to further explore this would be to instrument a newly constructed culvert.

Site-specific soil testing performed as part of this study highlighted the order of magnitude difficulty associated with obtaining soil elastic modulus values for Level 3 analytical modeling purposes. Several methods are available to determine soil elastic modulus, but values determined by these methods vary widely within a given soil stratum. Soil elastic modulus remains a complex and difficult material to quantify.

## **2. LIMITATIONS OF RESEARCH**

### ***1. Culvert Type***

This research only considered cast-in-place reinforced concrete box culverts. Though the principles outlined in the *Culvert Rating Guide* could be used to load rate other types of culverts, the analytical demand models and capacity calculations described in the *Guide* are for cast-in-place reinforced concrete box culverts.

### ***2. Culvert Drainage Condition***

Another significant limitation is the backfill drainage condition. Throughout this project, the culvert backfill has been assumed to be fully drained. This is often the case in the dryer portions of the state of Texas where culverts primarily serve to control flash flood conditions. However, in the wetter portions of the State, in particular toward the east and along the Gulf Coast, culverts often bridge over creeks and drainage ditches which are continually filled with water. The *Culvert Rating Guide* has not considered the effects of pore water pressure, buoyancy or saturation of backfill on the load rating.

### ***3. Soil Elastic Modulus***

The parametric study indicated that culvert load rating is highly sensitive to the soil modulus value for Level 3 analyses. Field testing explored several methods for determining soil elastic modulus, however, the soil elastic modulus vary widely within a given stratum. The modulus values provided in the *Culvert Rating Guide* can be used with significant engineering judgment. More work is necessary on this aspect of culvert load rating.

### ***4. Depth of Fill***

The field work was also limited relative to the depth of fill that was evaluated. All of the evaluated culverts had relatively low fill depths. Many in-service culverts in Texas are low fill culverts; however the Culvert Rating Guide should apply with equal confidence to all types of culverts in the TxDOT inventory. This means that more field work should be done to evaluate the *Guide's* modeling capabilities relative to deep fill culverts.

### ***5. Live Load Demand Measurements***

The field instrumentation portion of this study was limited to three in-service culverts. Though the findings from the instrumented load tests were reasonable, this is a limited validation of the live load demand predictions using the various models. Additional study would be appropriate.

## 6. *Dead Load Demand Measurements*

The field instrumentation portion of this study considered dead load for in a limited way for only one culvert project. This very limited effort did not provide conclusive validation of the dead load demand predictions. Additional work is necessary to increase confidence in the dead load predictions, particularly for the higher order models.

### 3. RECOMMENDATIONS

The *Culvert Rating Guide* developed as part of this research study represents a significant improvement in TxDOT's culvert load rating capabilities. It provides clear guidance for repeatable load rating, including the ability to reduce excess overconservatism in load ratings by taking into account soil-structure interaction effects.

The practices and procedures in the *Culvert Rating Guide* could be automated. Implementation might consist of pre-programmed worksheets that facilitate capacity calculations and model generation. A more sophisticated approach would input culvert details as outlined in Chapter 4 of the *Guide*, automatically calculate culvert capacity and demands per Chapter 5 and Chapter 6 of the *Guide*, and output the culvert load rating, critical section and failure mode.

Implementation of the *Culvert Rating Guide* could be further enhanced through development and dissemination of training materials, workshops, tutorials, other educational aids.

Notwithstanding the advance in culvert load rating procedure and practice embodied in the *Culvert Rating Guide*, the limitations identified above suggest the need to further explore several aspects of the culvert load rating problem. These include:

- Culvert Drainage Condition
- Soil Elastic Modulus
- Depth of Fill
- Live Load Demand Measurements
- Dead Load Demand Measurements

TxDOT culvert load rating analyses will continue to indicate that certain culverts should be load-posted or retrofitted when, in fact, many of these structures are probably serviceable. One type of response in such cases is to quote Section 7.4.1 of the *MCEB*: "A concrete [culvert] need not be posted for restricted loading when it has been carrying normal traffic for an appreciable amount of time and shows no distress" (AASHTO, 2003). A better response is further study of the load rating concepts identified above in order to illuminate the issues. Ideally such work will enable further refinement in

TxDOT's culvert load rating practices and procedures, the goal being to provide safe, effective and efficient movement of people and goods in Texas' roadway system.

## 8. BIBLIOGRAPHY

- AASHTO. (1949). *Standard Specifications for Highway Bridges 5th Ed.* Washington D.C.: American Association of State Highway Officials.
- AASHTO. (2007). *LRFD Bridge Design Specifications Customary Units 4th Ed.* Washington D.C.: American Association of State Highway and Transportation Officials.
- AASHTO. (2003). *Manual for Condition Evaluation of Bridges 2nd Ed.* Washington, D.C.: American Association of State Highway and Transportation Officials.
- AASHTO. (1977). *Standard Specifications for Highway Bridges 12th Ed.* Washington D.C.: American Association of State Highway and Transportation Officials.
- AASHTO. (1983). *Standard Specifications for Highway Bridges 13th Ed.* Washington D.C.: American Association of State Highway and Transportation Officials.
- AASHTO. (1989). *Standard Specifications for Highway Bridges 14th Ed.* Washington D.C.: American Association of State Highway and Transportation Officials.
- AASHTO. (1992). *Standard Specifications for Highway Bridges 15th Ed.* Washington D.C.: American Association of State Highway and Transportation Officials.
- AASHTO. (2002). *Standard Specifications for Highway Bridges 17th Ed.* Washington, D.C.: American Association of State Highway and Transportation Officials.
- Abdel-Karim, A. M., Tadros, M. K., & Benak, A. J. (1993). Structural Response of Full-Scale Concrete Box Culvert. *Struc. Eng.* , 119 (11), 3238-3254.
- Abdel-Karim, A. M., Tadros, M. K., & Benak, J. V. (1990). *Live Load Distribution on Concrete Box Culverts.* Washington DC: TRB.
- Abu-Farsakh, M. Y., Almohd, I., & Farrag, K. (2007). Comparison of Field and Laboratory Pullout Test on Geosynthetics in Marginal Soils. *Transportation Research Board No. 1975* , 124-136.
- Abu-Hejleh, N. M., Hanneman, D., Wang, T., & Ksouri, I. (2008). Evaluation and Recommendations for Flowfill and Mechanically Stabilized Earth Bridge Approaches. *Transportation Research Record No. 2045* , 51-61.
- Allen, T. (2001). *Development of the Simplified Method for Internal Stability Design of Mechanically Stabilized Earth Walls.* Olympia, Washington: Washing State Department of Transportation.
- Awwad, E. e. (2000). Finite element analysis of concrete box culverts. *Computing in Civil and Building Engineering* (pp. 1051-1053). Proc. of the Eight International Conference ASCE.



- Bennett, R. M. (2005). Vertical Loads on Concrete Box Culverts under High Embankments. *Bridge Eng.* , 10 (6), 643-649.
- Bowles, J. E. (1996). *Foundation Analysis and Design*. New York: McGraw Hill.
- Bowles, J. E. (1996). *Foundation Analysis and Design* (5th ed.). New York: McGraw-Hill.
- Briaud, J., Meriwether, M., & Porwoll, H. (1983). *Pressuremeter Design of Retaining Walls*. Arlington, TX: Texas Transportation Institute.
- Briaud, J.-L. (2005). *The Pressuremeter*. London: Taylor & Francis Group.
- Carrasco, B. (2008, October 7). Culvert Histogram by year built. (T. A. Wood, Interviewer)
- Chang, D. T., Sun, T. S., & Hung, F. Y. (1995). Pullout Mechanism of Geogrid under Confinement by Sandy and Clayey Soils. *Transportation Research Record No. 1474* , 64-72.
- Chang, J. C., Hannon, J. B., & Forsyth, R. A. (1977). Pull Resistance and Interaction of Earthwork Reinforcement and Soil. *Transportation Research Board 56th Annual Meeting*.
- Coduto, D. P. (2001). *Foundation Design Principles and Practices* (3rd ed.). Upper Saddle River, New Jersey: Prentice-Hall.
- Dasgupta, A., & Sengupta, B. (1991). Large-Scale Model Test on Square Box Culvert Backfilled with Sand. *Geotechnical Eng.* , 117 (1), 156-161.
- DGSI. (2005). *S-200 & S-205 Dynamim Cone Penetrometer Use and Operating Guidelines*. Stone Mountain, GA: Durham Geo Slope Indicator.
- Duane, J., Robinson, R., & Moore, C. A. (1986). Culvert-Soil Interaction Finite Element Analysis. *Transportation Eng.* , 112 (3), 250-263.
- Elton, D. J., & Patawaran, M. A. (2007). Mechanically Stabilized Earth Reinforcement Tensile Strength for Tests of Geotextile-Reinforced Soil. *Transportation Research Record No. 1868* , 81-88.
- FHWA. (1986). *Culvert Inspection Manual*. Washington D.C.: Federal Highway Administration.
- Frederick, G. R. (1988). *Investigation of the Structural Adequacy of C 850 Box Culverts*. Washington DC: TRB.
- Gardner, M. P., & Jeyapalan, J. K. (1982). *Preliminary Analysis of the Behavior of Reinforced Concrete Box Culverts*. Arlington, Tx: Texas Transportation Institute (TTI).

- Garg, A. K., Abolmaali, A., & Fernandez, R. (2007). Experimental Investigation of Shear Capacity of Precast Reinforced Concrete Box Culverts. *Bridge Eng. , 12*, 511.
- Gladstone, R. A., Anderson, P. L., Fishman, K. L., & Withiam, J. L. (2007). Durability of Galvanized Soil Reinforcement: More than 30 Years of Experience with Mechanically Stabilized Earth. *Transportation Research Record No. 1975* , 49-59.
- Jayawickrama, P. W., & Lawson, W. D. (2008). GEO102: Geotechnical Applications for Transportation Projects. Austin, Tx.
- Katona, M. G. (2008, May 21). (T. A. Wood, & W. D. Lawson, Interviewers)
- Katona, M. G. (1976). *CANDE-a Modern Approach for the Structural Design and Analysis of Buried Culverts*. Port Hueneme, Ca.: Naval Construction Battalion Center.
- Katona, M. G. (2007, July). Live Load Distributions for use in CANDE. (T. A. Wood, & W. D. Lawson, Interviewers)
- Katona, M. G. (1979). *Structural evaluation of new concepts for long-span culverts and culvert installations : interim report*. Springfield, Va.: Federal Highway Administration.
- Katona, M. G., & McGrath, T. J. (2007). A Guideline for Interpreting AASHTO LRFD Specifications to Design or Evaluate Buried Structures with Comprehensive Solution Methods. *Transportation Research Board 86th Annual Meeting*. Washington DC: TRB.
- Katona, M. G., & Smith, J. M. (1976). *CANDE User Manual*. Port Hueneme, Ca.: Naval Construction Battalion Center.
- Katona, M. G., & Vittes, P. D. (1982). *Soil-Structure Analysis and Evaluation of Buried Box-Culvert Designs*. Washington DC: TRB.
- Katona, M. G., Mlynarski, M., & McGrath, T. J. (2008). *CANDE-2007 Culvert Analysis and Design Solution Methods and Formulations*. National Cooperative Highway Research Project NCHRP 15-28.
- Kilgore, J. (2007, January 4). Evaluating Existing Culverts for Load Capacity Allowing for Soil Structure Interaction. *RTI Research Project Statement* . Austin, Texas: TxDOT.
- Kim, K., & Yoo, C. H. (2005). Design Loading on Deeply Buried Box Culverts. *Geotechnical & Geoenvironmental Eng. , 131* (1), 20-27.
- Kitane, Y., & McGrath, T. J. (2006). Three-Dimensional Modeling of Live Loads on Culverts. *ASCE Conf. Proc. 211*, (p. 82).

- Koerner, R. M. (1992). *GRI Test Methods and Standards: Geogrid Pullout*. Philadelphia, Pa.: Geosynthetic Research Institute, Drexel University.
- Lakmazaheri, S., & Edwards, P. (1996). *Integrated Culvert Design and Detailing in a CAD Environment*. Auburn, Al.: Auburn University.
- Latona, R. W., Heger, F. J., & Bealey, M. (1973). *Computerized Design of Precast Reinforced Concrete Box Culverts*. Washington DC: HRB.
- McCarthy, D. F. (2002). *Essentials of Soil Mechanics and Foundations*. Upper Saddle River, New Jersey: Prentice-Hall.
- McCarthy, D. F. (2007). *Essentials of Soil Mechanics and Foundations Basic Geotechnics*. Upper Saddle River, NJ: Pearson Prentice Hall.
- Mitchell, J. K., & Villet, C. V. (1987). *Reinforcement of Earth Slopes and Embankments*. Washington, D.C.: Transportation Research Board National Research Council.
- Mlynarski, M., Katona, M. G., & McGrath, T. J. (2008). *CANDE-2007 Culvert Analysis and Design User Manual and Guideline*. Moon Township, PA: National Cooperative Highway Research Project NCHRP 15-28.
- Morris, D., & Delphia, J. (1999). *Specifications for Backfill of Reinforced-Earth Retaining Walls*. College Station, Tx: Texas A&M University, Texas Transportation Institute (TTI).
- NAVFAC. (1986). *Soil Mechanics: NAVFAC DM 7.01*. Alexandria, VA: Naval Facilities Engineering Command.
- Nielsen, M. R., & Anderson, L. R. (1984). *Pullout Resistance of Wire Mats Embedded in Soil for Hilfiker Company*. Logan, Utah: Utah State University.
- Oswald, C. J. (1996). *Analysis of reinforced concrete culvert considering concrete creep and shrinkage*. Washington DC: TRB.
- PCA. (1975). *Concrete Culverts and Conduits*. Skokie, Il.: Portland Cement Association.
- PCA. (1992). *PCA Soil Primer*. Skokie, IL: Portland Cement Association.
- Peterson, L. M. (1980). *Pullout Resistance of Welded Wire Mesh Embedded in Soil*. Logan, Utah: Utah State University.
- Rathje, E., Rauch, A. F., Trejo, D., Folliard, K. J., Viyanant, C., Esfeller, M., et al. (2006). *Evaluation of Crushed Concrete and Recycled Asphalt Pavement As Backfill for Mechanically Stabilized Earth Walls*. Austin, TX: University of Texas at Austin, Center for Transportation Research (CTR).

- Rathje, E., Trejo, D., & Folliard, K. (2006). *Potential Use of Crushed Concrete and Recycled Asphalt Pavement as Backfill for MSE Walls*. Austin, Tx: University of Texas at Austin, Center for Transportation Research (CTR).
- Reese, L. C., & Wang, S. T. (2006, August 16). *Verification of Computer Program LPILE as a Valid Tool for Design of a Single Pile under Lateral Loading*. Retrieved March 25, 2009, from <http://www.ensoftin.com>.
- RISA Technologies. (2006). *RISA-3D (Version 6)*. Foothill Ranch, CA: RISA Technologies.
- Roschke, P. N., & Davis, R. E. (1986). Rigid Culvert Finite Element Analysis. *Geotechnical Eng.* , 112 (8), 749-767.
- Rund, R. E., & McGrath, T. J. (2000). *Comparison of AASHTO standard and LRFD code provisions for buried concrete box culverts*. ASTM Special Technical Publication.
- Seed, R., & Raines, J. R. (1988). *Failure of Flexible Long-Span Culverts Under Exceptional Live Loads*. Washington DC: TRB.
- Seki, G. Y., Pepe, F. J., & Chen, H.-P. (2002). Performance of a Drilled Shaft Retaining Wall and Abutment in Hawaii. *Deep Foundations 2002*, (pp. 728-742).
- Sharma, S., & Hardcastle, J. H. (1993). *Evaluation of culvert deformations using the finite element method*. Washington DC: TRB.
- Sisson, R. C., Harris, C. J., & Mokwa, R. L. (2004). Design of Cantilever Soldier Pile Retaining Walls in Stiff Clays and Claystones. *GeoSupport 2004: Innovation and Cooperation in the Geo-Industry* (pp. 309-321). Orlando, Florida: American Society of Civil Engineers.
- Spangler, M. G., Mason, C., & Winfrey, R. (1926). *Experimental determinations of static and impact loads transmitted to culverts*. Ames, Ia.: Iowa State College.
- Tadros, M. K. (1986). *Cost-Effective Concrete Box Culvert Design*. Lincoln, Ne: FHWA and Nebraska University.
- Tadros, M. K., & Benak, J. V. (1989). *Load Distribution On Box Culverts*. Lincoln, Ne.: FHWA and Nebraska University.
- Tadros, M. K., Benak, J. V., & Gilliland, M. K. (1989). Soil Pressure on Box Culverts. *ACI Structural Journal* , 86 (4), 439-450.
- Tarhini, K., Frederick, G. R., & Mabsout, M. (1996). Finite element analysis of precast concrete box culverts. *Congress on Computing in Civil Engineering*, (pp. 677-682).
- TxDOT. (2001). *Bridge Design Manual*. Austin, Tx: Texas Department of Transportation.

- TxDOT. (2002). *Bridge Inspection Manual*. Austin, Tx: Texas Department of Transportation.
- TxDOT. (2003). *Concrete Box Culvert Analysis Program - CULV5 Input Guide*. Austin: Texas Department of Transportation.
- TxDOT. (2003). *CULV5 - Concret Box Culvert Analysis Program*. Austin: Texas Department of Transportation.
- TxDOT. (2004). *CULV5 (Version 1.71) Readme.pdf*. Austin, Tx: Texas Department of Transportation.
- TxDOT. (2009). *Culvert Rating Guide*. Austin, TX: Texas Department of Transportation.
- TxDOT. (2006). *Geotechnical Manual*. Austin, TX: Texas Department of Transportation.
- TxDOT. (2008). *Pavement Design Guide*. Austin, Tx: Texas Department of Transportation.
- VanTil, e. (1972). *PCA Soil Primer*. Skokie, IL: Portland Cement Association.
- Vaslestad, J., Johansen, T. H., & Holm, W. (1993). *Load Reduction on Rigid Culverts Beneath High Fills: Long-Term Behavior*. Washington DC: TRB.
- Vidal, H. (1969). *The Principle of Reinforced Earth*. Highway Research Record No 282, Washington, D. C.
- Wang, S. T., & Reese, L. C. (1986). *Study of Design Method for Vertical Drilled Shaft Retaining Walls*. Austin, TX: Center for Tranporation Research.
- Wyoming DOT. (2008). *Analysis, Design and Rating of Reinforced Concrete Box Culverts BRASS-CULVERT*. Cheyenne, WY: Wyoming Department of Transportation.
- Yang, M. Z. (1997). Influence of Compaction Effort on Earth Pressure on a Box Culvert. *9th International Conference on the Assoc. for Computer Methods and Advances in Geomechanics*, (pp. 2021-2026). Wuhan, China.
- Yang, M. Z. (1999). Measurement of earth pressures on concrete box culverts under highway embankments. *Proceedings of the 1998 Field Instrumentation for Soil and Rock*, (pp. 87-100).

**APPENDIX A**  
**1938 ERA LOAD RATINGS**

APPENDIX TABLE 1. 1938 ERA SAMPLE DETAILS AND CULV-5 LOAD RATINGS

ID	SHEET	NO. OF SPANS	BARREL LENGTH (FT)	BARREL HEIGHT (FT)	FILL RANGE (FT)	MAX FILL DEPTH (FT)	ORIGINAL DESIGN YEAR	LAST REVISION DATE	CULV-5				
									IR (HS-)	OR (HS-)	CCS	CFM	LC
MBC-4-34 2 7X6W0	MBC-4-34	2	7.0	6.0	0.0	0.0	1934	NOV. 1938	7.5	12.5	WBIC	M	RLL
MBC-5-34 5 9X8W0	MBC-5-34	5	9.0	8.0	0.0	0.0	1934	NOV. 1938	0.0	0.0	0.0	0.0	0.0
MBC-2-34 4 5X5W0	MBC-2-34	4	5.0	5.0	0.0	0.0	1935	NOV. 1938	8.9	14.9	WBEC	M	TL
MBC-2-34 7 5X5W0	MBC-2-34	7	5.0	5.0	0.0	0.0	1935	NOV. 1938	0.0	0.0	0.0	0.0	0.0
MBC-3-34 3 6X4W0	MBC-3-34	3	6.0	4.0	0.0	0.0	1935	NOV. 1938	8.1	13.5	WBIC	M	RLL
MBC-6-40 3 10X10W0	MBC-6-40	3	10.0	10.0	0.0	0.0	1935	NOV. 1938	8.4	14.0	WTEC	M	TL
MBC-11-36 3 5X3W0	MBC-11-36	3	5.0	3.0	0.0	0.0	1936	JAN. 1944	8.1	13.5	WBIC	M	TL
MBC-12-36 4 5X5W0	MBC-12-36	4	5.0	5.0	0.0	0.0	1936	JAN. 1944	8.9	14.9	WBEC	M	TL
MBC-12-36 7 5X5W0	MBC-12-36	7	5.0	5.0	0.0	0.0	1936	JAN. 1944	0.0	0.0	0.0	0.0	0.0
MBC-14-36 2 7X7W0	MBC-14-36	2	7.0	7.0	0.0	0.0	1936	FEB. 1944	8.2	13.6	WBIC	M	RLL
MBC-14-36 3 8X7W0	MBC-14-36	3	8.0	7.0	0.0	0.0	1936	FEB. 1944	7.4	12.3	WBIC	M	RLL
MBC-15-36 3 8X8W0	MBC-15-36	3	8.0	8.0	0.0	0.0	1936	FEB. 1944	7.9	13.2	WBEC	M	RLL
MBC-16-36 5 10X8W0	MBC-16-36	5	10.0	8.0	0.0	0.0	1937	FEB. 1944	0.0	0.0	0.0	0.0	0.0
MBC-6-42-F 4 10X9W3	MBC-6-42-F	4	10.0	9.0	0.0 - 3.0	3.0	1935	NOV. 1938	11.3	18.8	WTEC	M	TL
MBC-16-44-F 2 10X10W3	MBC-16-44-F	2	10.0	10.0	0.0 - 3.0	3.0	1937	NOV. 1938	9.7	16.2	WTEC	M	TL
MBC-5-34-F 2 9X8W3	MBC-5-34-F	2	9.0	8.0	0.0 - 3.0	3.0	1937	NOV. 1938	2.2	3.7	WBEC	M	TL
MBC-4-34-F 4 8X7W4	MBC-4-34-F	4	8.0	7.0	0.0 - 4.0	4.0	1938	NOV. 1938	15.7	26.2	WBEC	M	TL
MBC-1-44-F 2 5X4W6	MBC-1-44-F	2	5.0	4.0	0.0 - 6.0	6.0	1935	OCT. 1938	27.9	46.6	WBEC	M	TL
MBC-11-40-F 7 5X4W6	MBC-11-40-F	7	5.0	4.0	0.0 - 6.0	6.0	1936	NOV. 1938	0.0	0.0	0.0	0.0	0.0
MBC-12-44-F 5 6X5W6	MBC-12-44-F	5	6.0	5.0	0.0 - 6.0	6.0	1936	NOV. 1938	0.0	0.0	0.0	0.0	0.0
MBC-12-44-F 6 6X6W6	MBC-12-44-F	6	6.0	6.0	0.0 - 6.0	6.0	1936	NOV. 1938	0.0	0.0	0.0	0.0	0.0
MBC-13-44-F 5 6X4W6	MBC-13-44-F	5	6.0	4.0	0.0 - 6.0	6.0	1936	NOV. 1938	0.0	0.0	0.0	0.0	0.0
MBC13-52-F 5 6X4W6	MBC13-52-F	5	6.0	4.0	0.0 - 6.0	6.0	1936	NOV. 1956	0.0	0.0	0.0	0.0	0.0
MBC-14-44-F 3 7X6W6	MBC-14-44-F	3	7.0	6.0	0.0 - 6.0	6.0	1936	NOV. 1938	8.4	14.1	WTEC	M	RL
MBC-2-34-F 5 5X5W6	MBC-2-34-F	5	5.0	5.0	0.0 - 6.0	6.0	1938	NOV. 1938	0.0	0.0	0.0	0.0	0.0
MBC-3-34-F 4 6X4W6	MBC-3-34-F	4	6.0	4.0	0.0 - 6.0	6.0	1938	JUN. 1939	17.9	29.8	WBEC	M	RLL
BC-4 1 8X7W8	BC-4	1	8.0	7.0	6.08 - 8.0	8.0	1934	JUL. 1938	18.1	30.2	WBEC	M	RLL
BC-4 1 9X8W12	BC-4	1	9.0	8.0	10.08 - 12.0	12.0	1934	JUL. 1938	18.8	31.4	WBEC	M	RLL
BC-4 1 9X9W14	BC-4	1	9.0	9.0	12.08 - 14.0	14.0	1934	JUL. 1938	-49.9	-83.2	BEM	M	RLL
BC-4 1 10X10W18	BC-4	1	10.0	10.0	16.08 - 18.0	18.0	1934	JUL. 1938	40.1	66.9	WEM	M	TL

APPENDIX TABLE 2. 1938 ERA RISA-2D WITH SPRINGS LOAD RATINGS

ID	RISA-2D SPG K=75PCI					RISA-2D SPG K=150PCI					RISA-2D SPG K=250PCI				
	IR (HS-)	OR (HS-)	CCS	CFM	LC	IR (HS-)	OR (HS-)	CCS	CFM	LC	IR (HS-)	OR (HS-)	CCS	CFM	LC
MBC-4-34 2 7X6W0	7.5	12.6	WBEC	M	RLL	8.3	13.8	WBEC	M	RLL	9.1	15.2	WBEC	M	RLL
MBC-5-34 5 9X8W0	7.1	11.8	WBEC	M	RLL	8.2	13.7	WBEC	M	RLL	9.6	16.1	WBEC	M	RLL
MBC-2-34 4 5X5W0	5.2	8.8	WBEC	M	RLL	5.7	9.5	WBEC	M	RLL	6.2	10.4	WBEC	M	RLL
MBC-2-34 7 5X5W0	4.9	8.2	WBEC	M	RLL	5.4	9.0	WBEC	M	RLL	5.9	9.9	WBEC	M	RLL
MBC-3-34 3 6X4W0	7.3	12.1	WTIC	M	RLL	8.0	13.3	WTIC	M	RLL	8.7	14.5	WTIC	M	RLL
MBC-6-40 3 10X10W0	6.7	11.3	WBEC	M	RLL	8.1	13.6	WTEC	M	RLL	9.7	16.1	WBEC	M	RLL
MBC-11-36 3 5X3W0	5.8	9.7	WBEC	M	RLL	6.1	10.2	WBEC	M	RLL	6.5	10.8	WBEC	M	RLL
MBC-12-36 4 5X5W0	5.2	8.8	WBEC	M	RLL	5.7	9.5	WBEC	M	RLL	6.2	10.4	WBEC	M	RLL
MBC-12-36 7 5X5W0	4.9	8.2	WBEC	M	RLL	5.4	9.0	WBEC	M	RLL	5.8	9.7	WBEC	M	RLL
MBC-14-36 2 7X7W0	7.4	12.3	WBEC	M	RLL	8.2	13.6	WBEC	M	RLL	9.1	15.1	WBEC	M	RLL
MBC-14-36 3 8X7W0	7.3	12.1	WBEC	M	RLL	8.0	13.4	WBEC	M	RLL	9.0	15.1	WBEC	M	RLL
MBC-15-36 3 8X8W0	7.6	12.7	WBEC	M	RLL	8.5	14.1	WBEC	M	RLL	9.5	15.8	WBEC	M	RLL
MBC-16-36 5 10X8W0	7.2	12.0	WBEC	M	RLL	8.8	14.6	WBEC	M	RLL	10.4	17.4	WBEC	M	RLL
MBC-6-42-F 4 10X9W3	19.7	33.0	WBEC	M	RLL	20.1	33.6	WTEC	M	TL	19.5	32.5	WTEC	M	TL
MBC-16-44-F 2 10X10W3	19.0	31.6	WTEC	M	TL	18.1	30.2	WTEC	M	TL	17.3	28.8	WTEC	M	TL
MBC-5-34-F 2 9X8W3	5.0	8.3	WBEC	M	RLL	6.4	10.6	WBEC	M	RLL	8.2	13.6	WBEC	M	RLL
MBC-4-34-F 4 8X7W4	20.5	34.3	WBEC	M	RLL	24.2	40.4	WBEC	M	RLL	26.1	43.6	WTEC	M	TL
MBC-1-44-F 2 5X4W6	39.4	65.7	WBEC	M	RLL	40.6	67.8	WBEC	M	RLL	42.6	71.1	WBEC	M	RLL
MBC-11-40-F 7 5X4W6	38.3	64.0	WTIC	M	RLL	48.9	81.6	WTIC	M	TL	58.4	97.6	WTIC	M	TL
MBC-12-44-F 5 6X5W6	25.0	41.7	WBEC	M	RLL	26.7	44.5	WBEC	M	RLL	29.4	49.1	WBEC	M	RLL
MBC-12-44-F 6 6X6W6	22.7	37.8	WBEC	M	RLL	24.7	41.3	WBEC	M	RLL	27.3	45.6	WBEC	M	RLL
MBC-13-44-F 5 6X4W6	23.2	38.7	WBEC	M	RLL	24.5	41.0	WBEC	M	RLL	26.7	44.6	WBEC	M	RLL
MBC13-52-F 5 6X4W6	23.2	38.7	WBEC	M	RLL	24.5	41.0	WBEC	M	RLL	26.7	44.6	WBEC	M	RLL
MBC-14-44-F 3 7X6W6	23.6	39.4	WTEC	M	RLL	24.7	41.2	WTEC	M	RLL	24.4	40.8	WTEC	M	RLL
MBC-2-34-F 5 5X5W6	32.0	53.4	WBEC	M	RLL	33.5	55.9	WBEC	M	RLL	35.8	59.7	WBEC	M	RLL
MBC-3-34-F 4 6X4W6	26.5	44.2	WBEC	M	RLL	28.4	47.3	WBEC	M	RLL	31.0	51.7	WBEC	M	RLL
BC-4 1 8X7W8	28.9	48.3	BEM	M	RLL	33.1	55.2	WEM	M	TL	31.5	52.6	WEM	M	TL
BC-4 1 9X8W12	43.7	73.0	WEM	M	TL	42.3	70.7	WEM	M	TL	40.6	67.7	WEM	M	TL
BC-4 1 9X9W14	-111.8	-186.7	BEM	M	TL	-76.2	#####	BEM	M	TL	-52.4	-87.4	BEM	M	RLL
BC-4 1 10X10W18	4.7	7.8	WEM	M	TL	3.7	6.1	WEM	M	TL	2.6	4.4	WEM	M	TL



APPENDIX TABLE 3. 1938 ERA RISA-2D WITH LEFE LOAD RATINGS

ID	RISA-2D LEFE E=8KSI				RISA-2D LEFE E=20KSI				RISA-2D LEFE E=36KSI			
	IR (HS-)	OR (HS-)	CCS	CFM	IR (HS-)	OR (HS-)	CCS	CFM	IR (HS-)	OR (HS-)	CCS	CFM
MBC-4-34 2 7X6W0	10.3	17.2	WBEC	M	11.5	19.1	WTIC	M	11.8	19.7	WTIC	M
MBC-5-34 5 9X8W0	2.4	4.0	WTIC	M	7.3	12.2	WTIC	M	9.4	15.6	WTIC	M
MBC-2-34 4 5X5W0	5.3	8.9	WBEC	M	10.1	16.8	WBEC	M	13.9	23.2	WTIC	M
MBC-2-34 7 5X5W0	5.4	9.0	WBEC	M	10.4	17.4	WBEC	M	14.9	24.9	WTIC	M
MBC-3-34 3 6X4W0	10.4	17.3	WTIC	M	12.5	20.8	WTIC	M	13.5	22.6	WTIC	M
MBC-6-40 3 10X10W0	-2.7	-4.5	WBEC	M	9.2	15.3	WBEC	M	14.9	24.9	WTIC	M
MBC-11-36 3 5X3W0	8.7	14.5	WTIC	M	10.9	18.1	WTIC	M	12.6	21.0	WTIC	M
MBC-12-36 4 5X5W0	5.3	8.8	WBEC	M	10.1	16.8	WBEC	M	13.9	23.2	WTIC	M
MBC-12-36 7 5X5W0	5.4	9.0	WBEC	M	10.4	17.4	WBEC	M	14.8	24.8	WTIC	M
MBC-14-36 2 7X7W0	7.8	13.0	WBEC	M	12.1	20.2	WTIC	M	12.6	21.1	WTIC	M
MBC-14-36 3 8X7W0	4.2	7.0	WTIC	M	8.0	13.3	WTIC	M	9.7	16.3	WTIC	M
MBC-15-36 3 8X8W0	2.8	4.6	WTIC	M	7.0	11.7	WTIC	M	9.2	15.3	WTIC	M
MBC-16-36 5 10X8W0	4.3	7.2	WBEC	M	15.0	25.1	WTIC	M	16.4	27.4	WTEC	M
MBC-6-42-F 4 10X9W3	2.6	4.3	WBEC	M	22.6	37.7	WTIC	M	33.1	55.3	WTIC	M
MBC-16-44-F 2 10X10W3	-0.3	-0.5	WBEC	M	21.8	36.5	WBEC	M	39.1	65.2	WTIC	M
MBC-5-34-F 2 9X8W3	-11.0	-18.4	WBEC	M	-0.2	-0.4	WBEC	M	13.3	22.2	WBEC	M
MBC-4-34-F 4 8X7W4	1.4	2.3	WBEC	M	26.6	44.4	WBEC	M	43.5	72.5	WTIC	M
MBC-1-44-F 2 5X4W6	13.8	23.1	WBEC	M	28.2	47.1	WBEC	M	46.6	77.7	WBEC	M
MBC-11-40-F 7 5X4W6	24.9	41.5	WTIC	M	53.8	89.8	WTIC	M	81.1	135.4	WTIC	M
MBC-12-44-F 5 6X5W6	-0.3	-0.6	WBEC	M	21.8	36.5	WBEC	M	46.7	77.9	WBEC	M
MBC-12-44-F 6 6X6W6	-8.5	-14.1	WBEC	M	10.8	18.0	WBEC	M	32.0	53.4	WBEC	M
MBC-13-44-F 5 6X4W6	9.6	16.1	WBEC	M	34.2	57.1	WBEC	M	62.4	104.1	WBEC	M
MBC13-52-F 5 6X4W6	9.6	16.1	WBEC	M	34.2	57.1	WBEC	M	62.4	104.1	WBEC	M
MBC-14-44-F 3 7X6W6	9.6	15.9	WBEC	M	40.1	67.0	WBEC	M	54.5	91.0	WTEC	M
MBC-2-34-F 5 5X5W6	-0.3	-0.6	WBEC	M	21.1	35.3	WBEC	M	45.5	76.0	WBEC	M
MBC-3-34-F 4 6X4W6	9.3	15.5	WBEC	M	32.7	54.6	WBEC	M	59.6	99.5	WBEC	M
BC-4 1 8X7W8	26.5	44.2	WBEC	M	68.3	114.0	WBEC	M	124.9	208.5	WBEC	M
BC-4 1 9X8W12	24.0	40.0	WBEC	M	70.7	118.0	WBEC	M	136.1	227.1	WBEC	M
BC-4 1 9X9W14	-11517.5	-19225.4	TEM	M	-890.0	-1485.7	BEM	M	19.0	31.6	BEM	M
BC-4 1 10X10W18	23.7	39.5	WBEC	M	64.6	107.8	WBEC	M	126.1	210.4	WBEC	M

**APPENDIX B**  
**1946 ERA LOAD RATINGS**

APPENDIX TABLE 4. 1946 ERA SAMPLE DETAILS AND CULV-5 LOAD RATINGS

ID	SHEET	NO. OF SPANS	BARREL LENGTH (FT)	BARREL HEIGHT (FT)	FILL RANGE (FT)	MAX FILL DEPTH (FT)	ORIGINAL DESIGN YEAR	LAST REVISION DATE	CULV-5				
									IR (HS-)	OR (HS-)	CCS	CFM	LC
MBC-3 7 3X3W0	MBC-3	7	3.0	3.0	0.0	0.0	1946	MAR. 1946	0.0	0.0	0.0	0.0	0.0
MBC-3 8 5X5W0	MBC-3	8	5.0	5.0	0.0	0.0	1946	MAR. 1946	0.0	0.0	0.0	0.0	0.0
MC10-3-45 4 10X10W6	MC10-3-45	4	10.0	10.0	4.08 - 6.0	6.0	THD#1 1949	DEC. 1949	-119.3	-199.1	WEM	M	TL
MC10-3-45 2 10X6W6	MC10-3-45	2	10.0	6.0	4.08 - 6.0	6.0	THD#1 1949	DEC. 1949	7.4	12.3	WBEC	M	TL
MC10-3-45 5 10X10W6	MC10-3-45	5	10.0	10.0	4.08 - 6.0	6.0	THD#1 1949	DEC. 1949	0.0	0.0	WEM	M	TL
MC10-3-45 3 10X7W6	MC10-3-45	3	10.0	7.0	4.08 - 6.0	6.0	THD#1 1949	DEC. 1949	5.1	8.5	BEM	M	RLL
FM-MBC-3-26 4 6X6W6	FM-MBC-3-26	4	6.0	6.0	0.0 - 6.0	6.0	1946	DEC. 1948	20.2	33.7	WTEC	M	TL
FM-MBC-3-26 6 6X6W6	FM-MBC-3-26	6	6.0	6.0	0.0 - 6.0	6.0	1946	DEC. 1948	0.0	0.0	WTEC	M	TL
FM-MBC-3-26 3 6X5W6	FM-MBC-3-26	3	6.0	5.0	0.0 - 6.0	6.0	1946	DEC. 1948	21.0	35.1	WBEC	M	RLL
FM-MBC-3-26 5 7X4W6	FM-MBC-3-26	5	7.0	4.0	0.0 - 6.0	6.0	1946	DEC. 1948	0.0	0.0	0.0	0.0	0.0

APPENDIX TABLE 5. 1946 ERA RISA-2D WITH SPRINGS LOAD RATINGS

ID	RISA-2D SPG K=75PCI					RISA-2D SPG K=150PCI					RISA-2D SPG K=250PCI				
	IR (HS-)	OR (HS-)	CCS	CFM	LC	IR (HS-)	OR (HS-)	CCS	CFM	LC	IR (HS-)	OR (HS-)	CCS	CFM	LC
MBC-3 7 3X3W0	2.9	4.9	WTIC	M	RLL	3.4	5.8	WTIC	M	RLL	3.9	6.5	WTEC	M	RLL
MBC-3 8 5X5W0	9.6	16.0	WTEC	M	RLL	11.3	18.9	WTEC	M	RLL	12.8	21.3	WTIC	M	RLL
MC10-3-45 4 10X10W6	-71.0	-118.5	WEM	M	TL	-68.1	-113.6	WEM	M	TL	-65.9	-109.9	WEM	M	TL
MC10-3-45 2 10X6W6	7.8	13.0	WBEC	M	TL	11.0	18.3	WTEC	M	TL	10.0	16.7	WTEC	M	TL
MC10-3-45 5 10X10W6	-73.8	-123.2	WEM	M	TL	-70.3	-117.4	WEM	M	TL	-67.7	-113.0	WEM	M	TL
MC10-3-45 3 10X7W6	5.5	9.1	WBEC	M	TL	9.3	15.6	TEM	M	RLL	9.5	15.9	TEM	M	RLL
FM-MBC-3-26 4 6X6W6	34.6	57.7	WTEC	M	RLL	35.3	58.9	WTEC	M	RLL	34.5	57.5	WTEC	M	RLL
FM-MBC-3-26 6 6X6W6	34.4	57.4	WTEC	M	RLL	35.0	58.4	WTEC	M	RLL	34.2	57.0	WTEC	M	RLL
FM-MBC-3-26 3 6X5W6	27.6	46.1	WBEC	M	RLL	31.1	51.9	WBEC	M	RLL	31.7	52.9	WTEC	M	RLL
FM-MBC-3-26 5 7X4W6	17.8	29.7	WBEC	M	RLL	20.8	34.8	WBEC	M	RLL	23.0	38.4	WBEC	M	RLL

APPENDIX TABLE 6. 1946 ERA RISA-2D WITH LEFE LOAD RATINGS

<i>ID</i>	<i>RISA-2D LEFE E=8KSI</i>				<i>RISA-2D LEFE E=20KSI</i>				<i>RISA-2D LEFE E=36KSI</i>			
	<i>IR (HS-)</i>	<i>OR (HS-)</i>	<i>CCS</i>	<i>CFM</i>	<i>IR (HS-)</i>	<i>OR (HS-)</i>	<i>CCS</i>	<i>CFM</i>	<i>IR (HS-)</i>	<i>OR (HS-)</i>	<i>CCS</i>	<i>CFM</i>
MBC-3 7 3X3W0	3.1	5.2	WTIC	M	4.9	8.2	WTIC	M	5.8	9.6	WTIC	M
MBC-3 8 5X5W0	10.6	17.6	WTIC	M	15.8	26.4	WTIC	M	18.2	30.5	WTIC	M
MC10-3-45 4 10X10W6	-26.9	-44.9	WBEC	M	0.7	1.2	WBEC	M	30.4	50.7	WBEC	M
MC10-3-45 2 10X6W6	-9.1	-15.2	WBEC	M	9.7	16.3	WBEC	M	30.8	51.3	WBEC	M
MC10-3-45 5 10X10W6	-26.0	-43.4	WBEC	M	2.4	4.0	WBEC	M	33.2	55.4	WBEC	M
MC10-3-45 3 10X7W6	-14.9	-24.9	WBEC	M	8.9	14.9	WBEC	M	35.2	58.8	WBEC	M
FM-MBC-3-26 4 6X6W6	6.2	10.3	WBEC	M	35.6	59.4	WBEC	M	69.0	115.2	WBEC	M
FM-MBC-3-26 6 6X6W6	6.8	11.4	WBEC	M	37.4	62.5	WBEC	M	72.1	120.4	WBEC	M
FM-MBC-3-26 3 6X5W6	11.3	18.8	WBEC	M	39.7	66.2	WBEC	M	72.5	120.9	WBEC	M
FM-MBC-3-26 5 7X4W6	20.6	34.4	WBEC	M	56.5	94.2	WTEC	M	83.3	139.1	WTEC	M

**APPENDIX C**  
**1958 ERA 36KSI STEEL LOAD RATINGS**

APPENDIX TABLE 7. 1958 ERA 36KSI STEEL SAMPLE DETAILS AND CULV-5 LOAD RATINGS

ID	SHEET	NO. OF SPANS	BARREL LENGTH (FT)	BARREL HEIGHT (FT)	FILL RANGE (FT)	MAX FILL DEPTH (FT)	ORIGINAL DESIGN YEAR	LAST REVISION DATE	CULV-5				
									IR (HS-)	OR (HS-)	CCS	CFM	LC
MC10-1 5 10X7W2	MC10-1	5	10.0	7.0	0.0 - 2.0	2.0	1958	NOV. 1964	0.0	0.0	0.0	0.0	0.0
MC10-1 6 10X9W2	MC10-1	6	10.0	9.0	0.0 - 2.0	2.0	1958	NOV. 1964	0.0	0.0	0.0	0.0	0.0
MC9-1 5 9X8W2	MC9-1	5	9.0	8.0	0.0 - 2.0	2.0	1958	NOV. 1964	0.0	0.0	0.0	0.0	0.0
MC9-1 4 9X6W2	MC9-1	4	9.0	6.0	0.0 - 2.0	2.0	1958	NOV. 1964	4.2	7.0	BEM	M	RLL
MC7-1 3 7X6W2	MC7-1	3	7.0	6.0	0.0 - 2.0	2.0	1958	NOV. 1964	4.3	7.2	BEM	M	RLL
MC7-1 2 7X4W2	MC7-1	2	7.0	4.0	0.0 - 2.0	2.0	1958	NOV. 1964	4.7	7.8	BEM	M	RLL
MC8-1 4 8X7W2	MC8-1	4	8.0	7.0	0.0 - 2.0	2.0	1958	NOV. 1964	3.9	6.4	BEM	M	RLL
MC8-1 3 8X5W2	MC8-1	3	8.0	5.0	0.0 - 2.0	2.0	1958	NOV. 1964	4.2	7.0	BEM	M	RLL
MC10-1 6 10X8W2	MC10-1	6	10.0	8.0	0.0 - 2.0	2.0	1958	NOV. 1964	0.0	0.0	0.0	0.0	0.0
MC8-1 4 8X6W2	MC8-1	4	8.0	6.0	0.0 - 2.0	2.0	1958	NOV. 1964	4.0	6.7	BEM	M	RLL
MC7-1 6 7X7W2	MC7-1	6	7.0	7.0	0.0 - 2.0	2.0	1958	NOV. 1964	0.0	0.0	0.0	0.0	0.0
MC6-1 5 6X5W4	MC6-1	5	6.0	5.0	0.0 - 4.0	4.0	1958	NOV. 1964	0.0	0.0	0.0	0.0	0.0
MC7-2 5 7X5W4	MC7-2	5	7.0	5.0	2.08 - 4.0	4.0	1958	NOV. 1964	0.0	0.0	0.0	0.0	0.0
MC7-2 6 7X7W4	MC7-2	6	7.0	7.0	2.08 - 4.0	4.0	1958	NOV. 1964	0.0	0.0	0.0	0.0	0.0
MC8-2 5 8X4W4	MC8-2	5	8.0	4.0	2.08 - 4.0	4.0	1958	NOV. 1964	0.0	0.0	0.0	0.0	0.0
MC8-2 6 8X6W4	MC8-2	6	8.0	6.0	2.08 - 4.0	4.0	1958	NOV. 1964	0.0	0.0	0.0	0.0	0.0
MC9-2 6 9X5W4	MC9-2	6	9.0	5.0	2.08 - 4.0	4.0	1958	NOV. 1964	0.0	0.0	0.0	0.0	0.0
MC10-2 2 10X9W4	MC10-2	2	10.0	9.0	2.08 - 4.0	4.0	1958	NOV. 1964	0.4	0.7	WEM	M	TL
MC6-1 4 6X3W4	MC6-1	4	6.0	3.0	0.0 - 4.0	4.0	1958	NOV. 1964	8.7	14.5	BEM	M	RLL
MC7-2 3 7X3W4	MC7-2	3	7.0	3.0	2.08 - 4.0	4.0	1958	NOV. 1964	10.7	17.8	BEM	M	RLL
MC7-2 4 7X3W4	MC7-2	4	7.0	3.0	2.08 - 4.0	4.0	1958	NOV. 1964	10.9	18.2	BEM	M	RLL
MC7-2 2 7X3W4	MC7-2	2	7.0	3.0	2.08 - 4.0	4.0	1958	NOV. 1964	11.7	19.5	BEM	M	RLL
MC8-2 5 8X6W4	MC8-2	5	8.0	6.0	2.08 - 4.0	4.0	1958	NOV. 1964	0.0	0.0	0.0	0.0	0.0
MC9-2 2 9X9W4	MC9-2	2	9.0	9.0	2.08 - 4.0	4.0	1958	NOV. 1964	-2.9	-4.8	WEM	M	TL

APPENDIX TABLE 7. 1958 ERA 36KSI STEEL SAMPLE DETAILS AND CULV-5 LOAD RATINGS (CONT.)

ID	SHEET	NO. OF SPANS	BARREL LENGTH (FT)	BARREL HEIGHT (FT)	FILL RANGE (FT)	MAX FILL DEPTH (FT)	ORIGINAL DESIGN YEAR	LAST REVISION DATE	CULV-5				
									IR (HS-)	OR (HS-)	CCS	CFM	LC
MC9-3 4 9X9W6	MC9-3	4	9.0	9.0	4.08 - 6.0	6.0	1958	NOV. 1964	-186.0	-310.5	WEM	M	TL
MC10-3 5 10X10W6	MC10-3	5	10.0	10.0	4.08 - 6.0	6.0	1958	NOV. 1964	0.0	0.0	0.0	0.0	0.0
MC6-2 6 6X3W6	MC6-2	6	6.0	3.0	4.08 - 6.0	6.0	1958	NOV. 1964	0.0	0.0	0.0	0.0	0.0
MC8-3 3 8X8W6	MC8-3	3	8.0	8.0	4.08 - 6.0	6.0	1958	NOV. 1964	4.7	7.9	WEM	M	TL
MC9-3 3 9X7W6	MC9-3	3	9.0	7.0	4.08 - 6.0	6.0	1958	NOV. 1964	5.2	8.6	WBEC	M	TL
MC5-2 3 5X4W6	MC5-2	3	5.0	4.0	4.08 - 6.0	6.0	1958	NOV. 1964	7.7	12.9	BEM	M	RLL
MC10-3 4 10X8W6	MC10-3	4	10.0	8.0	4.08 - 6.0	6.0	1958	NOV. 1964	8.8	14.7	WBEC	M	TL
MC10-3 3 10X6W6	MC10-3	3	10.0	6.0	4.08 - 6.0	6.0	1958	NOV. 1964	9.2	15.4	BEM	M	RLL
MC8-3 2 8X6W6	MC8-3	2	8.0	6.0	4.08 - 6.0	6.0	1958	NOV. 1964	11.1	18.5	BEM	M	RLL
MC9-3 2 9X5W6	MC9-3	2	9.0	5.0	4.08 - 6.0	6.0	1958	NOV. 1964	11.4	19.0	WBEC	M	TL
MC5-2 2 5X2W6	MC5-2	2	5.0	2.0	4.08 - 6.0	6.0	1958	NOV. 1964	12.7	21.3	BEM	M	RLL
MC7-3 2 7X7W6	MC7-3	2	7.0	7.0	4.08 - 6.0	6.0	1958	NOV. 1964	8.6	14.3	BIC	M	TL
MC7-3 4 7X4W6	MC7-3	4	7.0	4.0	4.08 - 6.0	6.0	1958	NOV. 1964	12.8	21.4	WBEC	M	TL
MC8-3 6 8X6W6	MC8-3	6	8.0	6.0	4.08 - 6.0	6.0	1958	NOV. 1964	0.0	0.0	0.0	0.0	0.0
MC9-3 3 9X9W6	MC9-3	3	9.0	9.0	4.08 - 6.0	6.0	1958	NOV. 1964	-150.0	-250.4	WEM	M	TL

APPENDIX TABLE 8. 1958 ERA 36KSI STEEL RISA-2D WITH SPRINGS LOAD RATINGS

ID	RISA-2D SPG K=75PCI					RISA-2D SPG K=150PCI					RISA-2D SPG K=250PCI				
	IR (HS-)	OR (HS-)	CCS	CFM	LC	IR (HS-)	OR (HS-)	CCS	CFM	LC	IR (HS-)	OR (HS-)	CCS	CFM	LC
MC10-1 5 10X7W2	5.2	8.6	WBEC	M	TL	5.9	9.9	WTEC	M	TL	5.6	9.4	WTEC	M	TL
MC10-1 6 10X9W2	1.3	2.1	WEM	M	TL	0.7	1.2	WEM	M	TL	0.2	0.3	WEM	M	TL
MC9-1 5 9X8W2	5.3	8.8	BEC	M	TL	7.4	12.4	TEC	M	TL	7.1	11.9	TEC	M	TL
MC9-1 4 9X6W2	5.5	9.2	WBEC	M	TL	6.4	10.7	WTEC	M	TL	6.2	10.3	WTEC	M	TL
MC7-1 3 7X6W2	5.8	9.7	BEM	M	RLL	6.8	11.3	BEM	M	RLL	7.3	12.2	WTIC	M	RLL
MC7-1 2 7X4W2	6.2	10.3	BEM	M	RLL	7.2	12.1	BEM	M	RLL	7.6	12.6	WTEC	M	TL
MC8-1 4 8X7W2	4.8	7.9	BEC	M	TL	6.3	10.6	WBEC	M	TL	6.9	11.5	WTEC	M	TL
MC8-1 3 8X5W2	6.1	10.2	WTIC	M	RLL	6.0	10.1	WTIC	M	RLL	6.0	10.1	WTIC	M	RLL
MC10-1 6 10X8W2	5.5	9.3	WBEC	M	TL	6.9	11.5	WTEC	M	TL	6.6	11.0	WTEC	M	TL
MC8-1 4 8X6W2	6.2	10.4	WBEC	M	TL	6.7	11.1	WTIC	M	RLL	6.6	11.1	WTIC	M	RLL
MC7-1 6 7X7W2	1.8	3.0	TIC	M	RLL	2.1	3.5	TIC	M	RLL	2.4	3.9	TIC	M	RLL
MC6-1 5 6X5W4	10.3	17.3	BEM	M	RLL	12.0	20.1	BEM	M	RLL	14.5	24.2	BEM	M	RLL
MC7-2 5 7X5W4	10.6	17.6	WBEC	M	TL	11.8	19.7	TEM	M	RLL	11.9	19.9	TEM	M	RLL
MC7-2 6 7X7W4	3.8	6.3	BEC	M	TL	5.6	9.4	BEC	M	TL	7.9	13.1	BEC	M	TL
MC8-2 5 8X4W4	8.6	14.4	TEM	M	RLL	8.7	14.6	TEM	M	RLL	8.9	14.8	TEM	M	RLL
MC8-2 6 8X6W4	9.0	15.0	TEM	M	RLL	9.1	15.2	TEM	M	RLL	9.2	15.4	TEM	M	RLL
MC9-2 6 9X5W4	8.7	14.6	TEM	M	RLL	8.8	14.8	TEM	M	RLL	9.0	15.0	TEM	M	RLL
MC10-2 2 10X9W4	-0.5	-0.8	WEM	M	TL	-1.1	-1.8	WEM	M	TL	-1.7	-2.9	WEM	M	TL
MC6-1 4 6X3W4	11.8	19.7	BEM	M	RLL	13.6	22.7	BEM	M	RLL	16.4	27.4	BEM	M	RLL
MC7-2 3 7X3W4	9.6	16.1	WBEC	M	TL	11.5	19.2	WTEC	M	TL	11.2	18.7	WTEC	M	TL
MC7-2 4 7X3W4	9.9	16.6	WBEC	M	TL	11.4	19.0	WTEC	M	TL	11.2	18.6	WTEC	M	TL
MC7-2 2 7X3W4	10.9	18.1	WBEC	M	TL	11.6	19.3	WTEC	M	TL	11.4	19.0	WTEC	M	TL
MC8-2 5 8X6W4	9.0	15.0	TEM	M	RLL	9.1	15.2	TEM	M	RLL	9.2	15.4	TEM	M	RLL
MC9-2 2 9X9W4	-3.7	-6.2	WEM	M	TL	-4.1	-6.9	WEM	M	TL	-4.7	-7.8	WEM	M	TL



APPENDIX TABLE 8. 1958 ERA 36KSI STEEL RISA-2D WITH SPRINGS LOAD RATINGS (CONT.)

ID	RISA-2D SPG K=75PCI					RISA-2D SPG K=150PCI					RISA-2D SPG K=250PCI				
	IR (HS-)	OR (HS-)	CCS	CFM	LC	IR (HS-)	OR (HS-)	CCS	CFM	LC	IR (HS-)	OR (HS-)	CCS	CFM	LC
MC9-3 4 9X9W6	-47.5	-79.4	WEM	M	TL	-44.9	-74.9	WEM	M	TL	-42.9	-71.7	WEM	M	TL
MC10-3 5 10X10W6	-67.3	-112.4	WEM	M	TL	-64.3	-107.4	WEM	M	TL	-62.0	-103.6	WEM	M	TL
MC6-2 6 6X3W6	15.8	26.3	TEM	M	RLL	15.9	26.6	TEM	M	RLL	16.1	26.9	TEM	M	RLL
MC8-3 3 8X8W6	3.9	6.5	WEM	M	TL	3.3	5.5	WEM	M	TL	2.5	4.2	WEM	M	TL
MC9-3 3 9X7W6	4.9	8.2	WBEC	M	TL	8.6	14.4	WBEC	M	TL	9.7	16.2	WTEC	M	TL
MC5-2 3 5X4W6	8.9	14.9	BEM	M	RLL	10.3	17.2	BEM	M	RLL	11.4	19.0	TEM	M	RLL
MC10-3 4 10X8W6	8.4	13.9	WBEC	M	TL	11.6	19.3	WEM	M	TL	10.3	17.2	WEM	M	TL
MC10-3 3 10X6W6	11.3	18.9	WBEC	M	TL	13.5	22.5	TEM	M	RLL	13.3	22.2	WTEC	M	TL
MC8-3 2 8X6W6	15.6	26.1	BEM	M	RLL	15.7	26.3	TEM	M	RLL	15.9	26.5	TEM	M	RLL
MC9-3 2 9X5W6	13.0	21.7	WBEC	M	TL	14.4	24.0	WTEC	M	TL	13.7	22.9	WTEC	M	TL
MC5-2 2 5X2W6	13.7	22.9	BEM	M	RLL	14.9	25.0	BEM	M	RLL	15.4	25.7	TEM	M	RLL
MC7-3 2 7X7W6	6.9	11.5	BEC	M	TL	7.3	12.1	WEM	M	TL	6.7	11.2	WEM	M	TL
MC7-3 4 7X4W6	14.0	23.3	WBEC	M	TL	16.6	27.7	WTEC	M	TL	16.0	26.7	WTEC	M	TL
MC8-3 6 8X6W6	13.8	23.0	TEM	M	RLL	14.0	23.4	TEM	M	RLL	14.3	23.9	TEM	M	RLL
MC9-3 3 9X9W6	-57.6	-96.1	WEM	M	TL	-51.9	-86.6	WEM	M	TL	-48.5	-80.9	WEM	M	TL

APPENDIX TABLE 9. 1958 ERA 36KSI STEEL RISA-2D WITH LEFE LOAD RATINGS

ID	RISA-2D LEFE E=8KSI				RISA-2D LEFE E=20KSI				RISA-2D LEFE E=36KSI			
	IR (HS-)	OR (HS-)	CCS	CFM	IR (HS-)	OR (HS-)	CCS	CFM	IR (HS-)	OR (HS-)	CCS	CFM
MC10-1 5 10X7W2	1.4	2.3	WBEC	M	9.9	16.6	WTIC	M	12.6	21.0	WTEC	M
MC10-1 6 10X9W2	-3.8	-6.3	BEC	M	9.5	15.8	WTIC	M	13.3	22.3	WTIC	M
MC9-1 5 9X8W2	-1.4	-2.4	BEC	M	9.9	16.5	WTIC	M	13.8	23.0	WTIC	M
MC9-1 4 9X6W2	4.0	6.6	WBEC	M	10.1	16.8	WTIC	M	13.0	21.8	WTEC	M
MC7-1 3 7X6W2	3.1	5.3	BEC	M	12.5	20.8	WTIC	M	16.4	27.4	WTEC	M
MC7-1 2 7X4W2	9.5	15.8	WBEC	M	13.2	22.0	WTEC	M	14.5	24.3	WTEC	M
MC8-1 4 8X7W2	0.4	0.6	BEC	M	11.0	18.4	WTIC	M	15.2	25.5	WTIC	M
MC8-1 3 8X5W2	7.0	11.6	WTIC	M	10.5	17.6	WTIC	M	13.8	23.1	WTIC	M
MC10-1 6 10X8W2	-0.5	-0.9	BEC	M	9.6	15.9	WTIC	M	13.0	21.7	WTIC	M
MC8-1 4 8X6W2	5.0	8.3	BEC	M	11.0	18.4	WTIC	M	14.8	24.6	WTIC	M
MC7-1 6 7X7W2	-0.6	-1.0	TIC	M	4.0	6.7	TIC	M	7.3	12.1	TIC	M
MC6-1 5 6X5W4	7.0	11.7	BEC	M	26.2	43.7	BEC	M	45.0	75.1	BEC	M
MC7-2 5 7X5W4	5.2	8.6	WBEC	M	22.4	37.5	WBEC	M	38.1	63.5	WTEC	M
MC7-2 6 7X7W4	-8.8	-14.7	BEC	M	6.3	10.6	WBEC	M	22.2	37.0	WBEC	M
MC8-2 5 8X4W4	11.8	19.8	WBEC	M	27.5	45.9	WTEC	M	35.6	59.3	WTEC	M
MC8-2 6 8X6W4	0.6	0.9	WBEC	M	19.5	32.5	WBEC	M	37.4	62.5	WTEC	M
MC9-2 6 9X5W4	5.8	9.6	WBEC	M	25.6	42.8	WBEC	M	32.9	55.0	WTEC	M
MC10-2 2 10X9W4	-10.9	-18.2	WBEC	M	9.0	15.0	WBEC	M	30.5	50.9	WBEC	M
MC6-1 4 6X3W4	18.9	31.6	WBEC	M	32.7	54.6	WTEC	M	41.5	69.2	WTEC	M
MC7-2 3 7X3W4	14.7	24.6	WBEC	M	25.9	43.2	WTEC	M	34.3	57.2	WTEC	M
MC7-2 4 7X3W4	14.7	24.5	WBEC	M	25.9	43.2	WTEC	M	34.7	57.9	WTEC	M
MC7-2 2 7X3W4	15.4	25.7	WBEC	M	25.7	43.0	WTEC	M	34.0	56.8	WTEC	M
MC8-2 5 8X6W4	0.2	0.4	WBEC	M	19.2	32.0	WBEC	M	37.6	62.8	WTEC	M
MC9-2 2 9X9W4	-14.6	-24.3	WBEC	M	1.7	2.9	WBEC	M	19.5	32.6	WBEC	M

APPENDIX TABLE 9. 1958 ERA 36KSI STEEL RISA-2D WITH LEFE LOAD RATINGS (CONT.)

ID	RISA-2D LEFE E=8KSI				RISA-2D LEFE E=20KSI				RISA-2D LEFE E=36KSI			
	IR (HS-)	OR (HS-)	CCS	CFM	IR (HS-)	OR (HS-)	CCS	CFM	IR (HS-)	OR (HS-)	CCS	CFM
MC9-3 4 9X9W6	-21.6	-36.1	WBEC	M	3.4	5.6	WBEC	M	30.4	50.8	WBEC	M
MC10-3 5 10X10W6	-19.2	-32.0	WBEC	M	12.8	21.3	WBEC	M	47.0	78.4	WBEC	M
MC6-2 6 6X3W6	24.9	41.5	WBEC	M	47.5	79.3	TEM	M	59.0	98.4	TIC	V
MC8-3 3 8X8W6	-12.1	-20.3	WBEC	M	10.5	17.5	WBEC	M	34.8	58.0	WBEC	M
MC9-3 3 9X7W6	-16.4	-27.3	WBEC	M	4.8	8.0	WBEC	M	27.7	46.2	WBEC	M
MC5-2 3 5X4W6	4.6	7.6	WBEC	M	21.9	36.6	WBEC	M	40.0	66.7	WBEC	M
MC10-3 4 10X8W6	-17.7	-29.5	WBEC	M	7.1	11.9	WBEC	M	33.7	56.3	WBEC	M
MC10-3 3 10X6W6	-6.2	-10.4	WBEC	M	17.6	29.4	WBEC	M	43.0	71.7	WBEC	M
MC8-3 2 8X6W6	-0.1	-0.2	WBEC	M	20.6	34.3	WBEC	M	43.5	72.5	WBEC	M
MC9-3 2 9X5W6	1.1	1.9	WBEC	M	22.5	37.5	WBEC	M	43.5	72.7	WTEC	M
MC5-2 2 5X2W6	17.3	28.9	TEM	M	28.8	48.1	TEM	M	45.4	75.7	TEM	M
MC7-3 2 7X7W6	-7.0	-11.7	WBEC	M	9.9	16.5	WBEC	M	29.2	48.8	WBEC	M
MC7-3 4 7X4W6	7.5	12.5	WBEC	M	31.3	52.3	WBEC	M	55.8	93.2	WTEC	M
MC8-3 6 8X6W6	-1.1	-1.8	WBEC	M	23.4	39.1	WBEC	M	49.9	83.3	WBEC	M
MC9-3 3 9X9W6	-21.3	-35.6	WBEC	M	2.8	4.6	WBEC	M	28.9	48.2	WBEC	M

**APPENDIX D**  
**1958 ERA 60KSI STEEL LOAD RATINGS**

APPENDIX TABLE 10. 1958 ERA 60KSI STEEL SAMPLE DETAILS AND CULV-5 LOAD RATINGS

ID	SHEET	NO. OF SPANS	BARREL LENGTH (FT)	BARREL HEIGHT (FT)	FILL RANGE (FT)	MAX FILL DEPTH (FT)	ORIGINAL DESIGN YEAR	LAST REVISION DATE	CULV-5				
									IR (HS-)	OR (HS-)	CCS	CFM	LC
MC10-1 5 10X7W2	MC10-1	5	10.0	7.0	0.0 - 2.0	2.0	1958	NOV. 1964	0.0	0.0	0.0	0.0	0.0
MC10-1 6 10X9W2	MC10-1	6	10.0	9.0	0.0 - 2.0	2.0	1958	NOV. 1964	0.0	0.0	0.0	0.0	0.0
MC9-1 5 9X8W2	MC9-1	5	9.0	8.0	0.0 - 2.0	2.0	1958	NOV. 1964	0.0	0.0	0.0	0.0	0.0
MC9-1 4 9X6W2	MC9-1	4	9.0	6.0	0.0 - 2.0	2.0	1958	NOV. 1964	10.2	17.0	BEM	M	RLL
MC7-1 3 7X6W2	MC7-1	3	7.0	6.0	0.0 - 2.0	2.0	1958	NOV. 1964	10.1	16.9	BEM	M	RLL
MC7-1 2 7X4W2	MC7-1	2	7.0	4.0	0.0 - 2.0	2.0	1958	NOV. 1964	10.4	17.4	BEM	M	RLL
MC8-1 4 8X7W2	MC8-1	4	8.0	7.0	0.0 - 2.0	2.0	1958	NOV. 1964	9.4	15.6	BEM	M	RLL
MC8-1 3 8X5W2	MC8-1	3	8.0	5.0	0.0 - 2.0	2.0	1958	NOV. 1964	10.0	16.7	BEM	M	RLL
MC10-1 6 10X8W2	MC10-1	6	10.0	8.0	0.0 - 2.0	2.0	1958	NOV. 1964	0.0	0.0	0.0	0.0	0.0
MC8-1 4 8X6W2	MC8-1	4	8.0	6.0	0.0 - 2.0	2.0	1958	NOV. 1964	9.7	16.2	BEM	M	RLL
MC7-1 6 7X7W2	MC7-1	6	7.0	7.0	0.0 - 2.0	2.0	1958	NOV. 1964	0.0	0.0	0.0	0.0	0.0
MC6-1 5 6X5W4	MC6-1	5	6.0	5.0	0.0 - 4.0	4.0	1958	NOV. 1964	0.0	0.0	0.0	0.0	0.0
MC7-2 5 7X5W4	MC7-2	5	7.0	5.0	2.08 - 4.0	4.0	1958	NOV. 1964	0.0	0.0	0.0	0.0	0.0
MC7-2 6 7X7W4	MC7-2	6	7.0	7.0	2.08 - 4.0	4.0	1958	NOV. 1964	0.0	0.0	0.0	0.0	0.0
MC8-2 5 8X4W4	MC8-2	5	8.0	4.0	2.08 - 4.0	4.0	1958	NOV. 1964	0.0	0.0	0.0	0.0	0.0
MC8-2 6 8X6W4	MC8-2	6	8.0	6.0	2.08 - 4.0	4.0	1958	NOV. 1964	0.0	0.0	0.0	0.0	0.0
MC9-2 6 9X5W4	MC9-2	6	9.0	5.0	2.08 - 4.0	4.0	1958	NOV. 1964	0.0	0.0	0.0	0.0	0.0
MC10-2 2 10X9W4	MC10-2	2	10.0	9.0	2.08 - 4.0	4.0	1958	NOV. 1964	12.2	20.4	WEM	M	TL
MC6-1 4 6X3W4	MC6-1	4	6.0	3.0	0.0 - 4.0	4.0	1958	NOV. 1964	24.0	40.1	BEM	M	RLL
MC7-2 3 7X3W4	MC7-2	3	7.0	3.0	2.08 - 4.0	4.0	1958	NOV. 1964	26.9	44.9	TEM	M	RLL
MC7-2 4 7X3W4	MC7-2	4	7.0	3.0	2.08 - 4.0	4.0	1958	NOV. 1964	27.1	45.2	TEM	M	RLL
MC7-2 2 7X3W4	MC7-2	2	7.0	3.0	2.08 - 4.0	4.0	1958	NOV. 1964	28.5	47.5	BIC	V	RLL
MC8-2 5 8X6W4	MC8-2	5	8.0	6.0	2.08 - 4.0	4.0	1958	NOV. 1964	0.0	0.0	0.0	0.0	0.0
MC9-2 2 9X9W4	MC9-2	2	9.0	9.0	2.08 - 4.0	4.0	1958	NOV. 1964	9.3	15.5	WEM	M	TL

APPENDIX TABLE 10. 1958 ERA 60KSI STEEL SAMPLE DETAILS AND CULV-5 LOAD RATINGS (CONT.)

ID	SHEET	NO. OF SPANS	BARREL LENGTH (FT)	BARREL HEIGHT (FT)	FILL RANGE (FT)	MAX FILL DEPTH (FT)	ORIGINAL DESIGN YEAR	LAST REVISION DATE	IR (HS-)	OR (HS-)	CULV-5		
											CCS	CFM	LC
MC9-3 4 9X9W6	MC9-3	4	9.0	9.0	4.08 - 6.0	6.0	1958	NOV. 1964	7.3	12.1	WEM	M	TL
MC10-3 5 10X10W6	MC10-3	5	10.0	10.0	4.08 - 6.0	6.0	1958	NOV. 1964	0.0	0.0	0.0	0.0	0.0
MC6-2 6 6X3W6	MC6-2	6	6.0	3.0	4.08 - 6.0	6.0	1958	NOV. 1964	0.0	0.0	0.0	0.0	0.0
MC8-3 3 8X8W6	MC8-3	3	8.0	8.0	4.08 - 6.0	6.0	1958	NOV. 1964	22.3	37.1	WEM	M	TL
MC9-3 3 9X7W6	MC9-3	3	9.0	7.0	4.08 - 6.0	6.0	1958	NOV. 1964	35.6	59.5	BIC	V	RLL
MC5-2 3 5X4W6	MC5-2	3	5.0	4.0	4.08 - 6.0	6.0	1958	NOV. 1964	34.7	57.9	BEM	M	RLL
MC10-3 4 10X8W6	MC10-3	4	10.0	8.0	4.08 - 6.0	6.0	1958	NOV. 1964	28.2	47.0	WEM	M	TL
MC10-3 3 10X6W6	MC10-3	3	10.0	6.0	4.08 - 6.0	6.0	1958	NOV. 1964	37.0	61.8	BEM	M	RLL
MC8-3 2 8X6W6	MC8-3	2	8.0	6.0	4.08 - 6.0	6.0	1958	NOV. 1964	31.7	52.8	BIC	V	RLL
MC9-3 2 9X5W6	MC9-3	2	9.0	5.0	4.08 - 6.0	6.0	1958	NOV. 1964	35.4	59.1	BIC	V	RLL
MC5-2 2 5X2W6	MC5-2	2	5.0	2.0	4.08 - 6.0	6.0	1958	NOV. 1964	42.8	71.4	BEM	M	RLL
MC7-3 2 7X7W6	MC7-3	2	7.0	7.0	4.08 - 6.0	6.0	1958	NOV. 1964	26.4	44.1	BIC	V	RLL
MC7-3 4 7X4W6	MC7-3	4	7.0	4.0	4.08 - 6.0	6.0	1958	NOV. 1964	30.6	51.1	BIC	V	RLL
MC8-3 6 8X6W6	MC8-3	6	8.0	6.0	4.08 - 6.0	6.0	1958	NOV. 1964	0.0	0.0	0.0	0.0	0.0
MC9-3 3 9X9W6	MC9-3	3	9.0	9.0	4.08 - 6.0	6.0	1958	NOV. 1964	7.9	13.1	WEM	M	TL

APPENDIX TABLE 11. 1958 ERA 60KSI STEEL RISA-2D WITH SPRINGS LOAD RATINGS

ID	RISA-2D SPG K=75PCI					RISA-2D SPG K=150PCI					RISA-2D SPG K=250PCI				
	IR (HS-)	OR (HS-)	CCS	CFM	LC	IR (HS-)	OR (HS-)	CCS	CFM	LC	IR (HS-)	OR (HS-)	CCS	CFM	LC
MC10-1 5 10X7W2	12.2	20.4	WTIC	M	TL	12.7	21.2	WTIC	M	RLL	12.4	20.7	WTEC	M	TL
MC10-1 6 10X9W2	13.3	22.2	WEM	M	TL	12.5	20.8	WEM	M	TL	11.8	19.7	WEM	M	TL
MC9-1 5 9X8W2	13.0	21.7	WTIC	M	RLL	13.6	22.7	WTIC	M	RLL	13.6	22.7	WTIC	M	RLL
MC9-1 4 9X6W2	11.9	19.9	WTIC	M	RLL	11.7	19.5	WTIC	M	RLL	11.5	19.2	WTIC	M	RLL
MC7-1 3 7X6W2	11.8	19.6	WTIC	M	RLL	12.3	20.5	WTIC	M	RLL	12.6	21.0	WTIC	M	RLL
MC7-1 2 7X4W2	12.8	21.4	WBEC	M	TL	14.3	23.8	WTEC	M	TL	14.0	23.4	WTEC	M	TL
MC8-1 4 8X7W2	12.0	20.0	WTIC	M	RLL	12.3	20.5	WTIC	M	RLL	12.1	20.2	WTIC	M	RLL
MC8-1 3 8X5W2	10.9	18.2	WTIC	M	RLL	10.6	17.8	WTIC	M	RLL	10.5	17.6	WTIC	M	RLL
MC10-1 6 10X8W2	12.7	21.2	WTIC	M	RLL	13.4	22.3	WTIC	M	RLL	13.6	22.7	WTIC	M	RLL
MC8-1 4 8X6W2	11.9	19.9	WTIC	M	RLL	11.6	19.4	WTIC	M	RLL	11.5	19.1	WTIC	M	RLL
MC7-1 6 7X7W2	5.9	9.8	TIC	M	RLL	6.5	10.9	TIC	M	RLL	7.0	11.6	TIC	M	RLL
MC6-1 5 6X5W4	27.6	46.0	TIC	V	RLL	28.0	46.8	TIC	V	RLL	28.4	47.5	TIC	V	RLL
MC7-2 5 7X5W4	26.5	44.3	TIC	V	RLL	26.9	44.9	TIC	V	RLL	27.2	45.4	TIC	V	RLL
MC7-2 6 7X7W4	22.6	37.7	BEC	M	TL	26.6	44.5	TEM	M	RLL	26.5	44.3	WTEC	M	TL
MC8-2 5 8X4W4	23.0	38.3	TEM	M	RLL	23.2	38.7	TEM	M	RLL	23.4	39.0	TEM	M	RLL
MC8-2 6 8X6W4	23.4	39.0	TEM	M	RLL	23.5	39.3	TEM	M	RLL	23.8	39.7	TEM	M	RLL
MC9-2 6 9X5W4	23.6	39.5	TEM	M	RLL	23.8	39.8	TEM	M	RLL	24.0	40.1	TEM	M	RLL
MC10-2 2 10X9W4	12.3	20.6	WEM	M	TL	12.0	20.0	WEM	M	TL	11.5	19.2	WEM	M	TL
MC6-1 4 6X3W4	23.9	39.9	WTIC	M	RLL	26.0	43.5	WTIC	M	RLL	27.8	46.4	WTIC	M	RLL
MC7-2 3 7X3W4	20.0	33.3	WTIC	M	RLL	21.1	35.2	WTIC	M	RLL	22.0	36.7	WTIC	M	RLL
MC7-2 4 7X3W4	23.2	38.8	WTIC	M	RLL	24.3	40.6	WTIC	M	TL	25.1	41.9	WTIC	M	TL
MC7-2 2 7X3W4	26.0	43.4	WTEC	M	TL	25.8	43.0	WTEC	M	TL	25.5	42.6	WTEC	M	TL
MC8-2 5 8X6W4	23.3	38.9	TEM	M	RLL	23.5	39.3	TEM	M	RLL	23.7	39.6	TEM	M	RLL
MC9-2 2 9X9W4	9.1	15.2	WEM	M	TL	8.9	14.9	WEM	M	TL	8.6	14.3	WEM	M	TL

APPENDIX TABLE 11. 1958 ERA 60KSI STEEL RISA-2D WITH SPRINGS LOAD RATINGS (CONT.)

ID	RISA-2D SPG K=75PCI					RISA-2D SPG K=150PCI					RISA-2D SPG K=250PCI				
	IR (HS-)	OR (HS-)	CCS	CFM	LC	IR (HS-)	OR (HS-)	CCS	CFM	LC	IR (HS-)	OR (HS-)	CCS	CFM	LC
MC9-3 4 9X9W6	7.7	12.8	WEM	M	TL	7.1	11.8	WEM	M	TL	6.4	10.7	WEM	M	TL
MC10-3 5 10X10W6	-17.4	-29.0	WEM	M	TL	-17.9	-29.8	WEM	M	TL	-18.7	-31.1	WEM	M	TL
MC6-2 6 6X3W6	35.3	58.9	TIC	V	RLL	35.5	59.3	TIC	V	RLL	35.9	59.9	TIC	V	RLL
MC8-3 3 8X8W6	21.5	35.9	WEM	M	TL	20.8	34.7	WEM	M	TL	20.0	33.3	WEM	M	TL
MC9-3 3 9X7W6	38.4	64.0	TIC	V	RLL	37.6	62.8	WEM	M	TL	36.3	60.7	WEM	M	TL
MC5-2 3 5X4W6	37.3	62.3	BEM	M	RLL	38.9	64.9	TEM	M	RLL	39.1	65.3	TEM	M	RLL
MC10-3 4 10X8W6	31.7	52.9	WEM	M	TL	30.4	50.7	WEM	M	TL	29.1	48.5	WEM	M	TL
MC10-3 3 10X6W6	40.4	67.5	TIC	V	RLL	40.6	67.8	TIC	V	RLL	40.6	67.7	WTEC	M	TL
MC8-3 2 8X6W6	34.4	57.3	TIC	V	RLL	34.8	58.1	TIC	V	RLL	35.2	58.8	TIC	V	RLL
MC9-3 2 9X5W6	37.6	62.7	TIC	V	RLL	38.1	63.5	TIC	V	RLL	38.5	64.2	TIC	V	RLL
MC5-2 2 5X2W6	45.2	75.5	BEM	M	RLL	46.1	76.9	TEM	M	RLL	46.3	77.3	TEM	M	RLL
MC7-3 2 7X7W6	25.1	41.9	WEM	M	TL	24.9	41.6	WEM	M	TL	24.5	41.0	WEM	M	TL
MC7-3 4 7X4W6	33.5	55.9	TIC	V	RLL	33.8	56.4	TIC	V	RLL	34.1	56.9	TIC	V	RLL
MC8-3 6 8X6W6	36.4	60.8	TIC	V	RLL	36.8	61.4	TIC	V	RLL	37.2	62.1	TIC	V	RLL
MC9-3 3 9X9W6	7.7	12.8	WEM	M	TL	7.1	11.8	WEM	M	TL	6.4	10.6	WEM	M	TL



APPENDIX TABLE 12. 1958 ERA 60KSI STEEL RISA-2D WITH LEFE LOAD RATINGS

ID	RISA-2D LEFE E=8KSI				RISA-2D LEFE E=20KSI				RISA-2D LEFE E=36KSI			
	IR (HS-)	OR (HS-)	CCS	CFM	IR (HS-)	OR (HS-)	CCS	CFM	IR (HS-)	OR (HS-)	CCS	CFM
MC10-1 5 10X7W2	11.5	19.2	WTIC	M	17.5	29.2	WTIC	M	22.8	38.1	WTIC	M
MC10-1 6 10X9W2	10.3	17.1	WTIC	M	17.5	29.2	WTIC	M	23.3	38.8	WTIC	M
MC9-1 5 9X8W2	11.0	18.4	WTIC	M	18.1	30.2	WTIC	M	23.1	38.6	TIC	V
MC9-1 4 9X6W2	12.1	20.1	WTIC	M	17.7	29.6	WTIC	M	23.0	38.3	WTIC	M
MC7-1 3 7X6W2	14.9	24.9	WTIC	M	21.4	35.7	TIC	V	23.4	39.1	TIC	V
MC7-1 2 7X4W2	18.0	30.0	WTIC	M	21.3	35.6	TIC	V	23.3	38.9	TIC	V
MC8-1 4 8X7W2	12.3	20.6	WTIC	M	19.9	33.1	WTIC	M	22.3	37.3	TIC	V
MC8-1 3 8X5W2	13.2	22.1	WTIC	M	18.4	30.7	WTIC	M	22.2	37.0	TIC	V
MC10-1 6 10X8W2	10.9	18.2	WTIC	M	17.2	28.7	WTIC	M	22.4	37.3	WTIC	M
MC8-1 4 8X6W2	12.9	21.6	WTIC	M	19.4	32.4	WTIC	M	22.3	37.1	TIC	V
MC7-1 6 7X7W2	6.8	11.3	TIC	M	12.8	21.4	TIC	M	17.7	29.5	TIC	M
MC6-1 5 6X5W4	34.2	57.0	TIC	V	41.8	69.8	TIC	V	48.3	80.6	TIC	V
MC7-2 5 7X5W4	30.6	51.0	WBEC	M	43.0	71.7	TIC	V	49.9	83.2	TIC	V
MC7-2 6 7X7W4	13.1	21.9	BEC	M	39.0	65.1	WBEC	M	49.8	83.2	TIC	V
MC8-2 5 8X4W4	30.5	50.8	WTIC	M	44.4	74.2	TIC	V	51.6	86.1	TIC	V
MC8-2 6 8X6W4	27.2	45.3	WBEC	M	44.4	74.2	TIC	V	51.7	86.4	TIC	V
MC9-2 6 9X5W4	28.0	46.7	WTIC	M	47.8	79.7	WTIC	M	56.2	93.7	TIC	V
MC10-2 2 10X9W4	19.2	32.1	WBEC	M	47.3	78.9	TIC	V	54.9	91.7	TIC	V
MC6-1 4 6X3W4	35.3	58.9	TIC	V	42.1	70.3	TIC	V	48.0	80.1	TIC	V
MC7-2 3 7X3W4	34.1	57.0	WTIC	M	42.9	71.5	TIC	V	49.2	82.1	TIC	V
MC7-2 4 7X3W4	33.7	56.2	WTIC	M	42.7	71.2	TIC	V	49.3	82.3	TIC	V
MC7-2 2 7X3W4	34.1	56.9	TIC	V	40.8	68.1	TIC	V	47.6	79.4	TIC	V
MC8-2 5 8X6W4	27.0	45.0	WBEC	M	44.0	73.4	TIC	V	51.1	85.3	TIC	V
MC9-2 2 9X9W4	11.9	19.8	WBEC	M	39.7	66.3	WBEC	M	54.4	90.9	TIC	V

APPENDIX TABLE 12. 1958 ERA 60KSI STEEL RISA-2D WITH LEFE LOAD RATINGS (CONT.)

ID	RISA-2D LEFE E=8KSI				RISA-2D LEFE E=20KSI				RISA-2D LEFE E=36KSI			
	IR (HS-)	OR (HS-)	CCS	CFM	IR (HS-)	OR (HS-)	CCS	CFM	IR (HS-)	OR (HS-)	CCS	CFM
MC9-3 4 9X9W6	15.4	25.7	WBEC	M	58.1	97.0	WBEC	M	69.5	116.0	TIC	V
MC10-3 5 10X10W6	21.1	35.3	WTIC	M	63.2	105.5	TIC	V	73.4	122.6	TIC	V
MC6-2 6 6X3W6	40.8	68.0	TIC	V	50.1	83.6	TIC	V	58.5	97.6	TIC	V
MC8-3 3 8X8W6	24.0	40.1	WBEC	M	49.9	83.3	BEC	V	63.5	106.0	TIC	V
MC9-3 3 9X7W6	17.4	29.1	WBEC	M	54.0	90.2	WBEC	M	70.6	117.9	TIC	V
MC5-2 3 5X4W6	39.4	65.7	WBEC	M	56.0	93.5	TIC	V	64.9	108.3	TIC	V
MC10-3 4 10X8W6	20.7	34.5	WBEC	M	63.3	105.7	WBEC	M	73.2	122.1	TIC	V
MC10-3 3 10X6W6	31.1	51.9	WBEC	M	64.3	107.4	TIC	V	73.9	123.3	TIC	V
MC8-3 2 8X6W6	36.5	60.9	WBEC	M	52.2	87.2	TIC	V	62.3	104.0	TIC	V
MC9-3 2 9X5W6	38.1	63.6	WBEC	M	57.1	95.3	TIC	V	67.5	112.6	TIC	V
MC5-2 2 5X2W6	46.3	77.2	TEM	M	54.0	90.1	TIC	V	61.7	103.0	TIC	V
MC7-3 2 7X7W6	23.3	39.0	WBEC	M	44.0	73.5	BEC	V	54.8	91.5	TIC	V
MC7-3 4 7X4W6	39.7	66.2	TIC	V	49.5	82.7	TIC	V	57.8	96.5	TIC	V
MC8-3 6 8X6W6	35.5	59.3	WBEC	M	56.2	93.8	TIC	V	65.6	109.5	TIC	V
MC9-3 3 9X9W6	15.4	25.7	WBEC	M	56.4	94.1	WBEC	M	69.4	115.8	TIC	V

**APPENDIX E**  
**2003 ERA LOAD RATINGS**

APPENDIX TABLE 13. 2003 ERA SAMPLE DETAILS AND CULV-5 LOAD RATINGS

ID	SHEET	NO. OF SPANS	BARREL LENGTH (FT)	BARREL HEIGHT (FT)	FILL RANGE (FT)	MAX FILL DEPTH (FT)	ORIGINAL DESIGN YEAR	LAST REVISION DATE	IR (HS-)	OR (HS-)	CULV-5		
											CCS	CFM	LC
MC-10-7 3 10X8W7	MC-10-7	3	10.0	8.0	0.0 - 7.0	7.0	2003	DEC. 2003	25.6	42.7	WBEC	M	TL
MC-10-7 4 10X6W7	MC-10-7	4	10.0	6.0	0.0 - 7.0	7.0	2003	DEC. 2003	38.2	63.8	WEM	M	TL
MC-9-10 2 9X6W10	MC-9-10	2	9.0	6.0	0.0 - 10.0	10.0	2003	DEC. 2003	36.2	60.4	BIC	V	RLL
MC-7-10 5 7X7W10	MC-7-10	5	7.0	7.0	0.0 - 10.0	10.0	2003	DEC. 2003	0.0	0.0	0.0	0.0	0.0
MC-7-10 6 7X5W10	MC-7-10	6	7.0	5.0	0.0 - 10.0	10.0	2003	DEC. 2003	0.0	0.0	0.0	0.0	0.0
MC-10-10 2 10X5W10	MC-10-10	2	10.0	5.0	2.0 - 10.0	10.0	2003	DEC. 2003	45.6	76.2	BIC	V	RLL
MC-7-16 3 7X6W16	MC-7-16	3	7.0	6.0	2.0 - 16.0	16.0	2003	DEC. 2003	52.2	87.2	BIC	V	RLL
MC-7-16 4 7X4W16	MC-7-16	4	7.0	4.0	2.0 - 16.0	16.0	2003	DEC. 2003	55.2	92.1	BIC	V	RLL
MC-5-20 2 5X3W20	MC-5-20	2	5.0	3.0	0.0 - 20.0	20.0	2003	DEC. 2003	69.0	115.2	BIC	V	RLL
MC-8-20 6 8X6W20	MC-8-20	6	8.0	6.0	2.0 - 20.0	20.0	2003	DEC. 2003	0.0	0.0	0.0	0.0	0.0
MC-8-20 5 8X8W20	MC-8-20	5	8.0	8.0	2.0 - 20.0	20.0	2003	DEC. 2003	0.0	0.0	0.0	0.0	0.0
MC-10-20 5 10X10W20	MC-10-20	5	10.0	10.0	2.0 - 20.0	20.0	2003	DEC. 2003	0.0	0.0	0.0	0.0	0.0
MC-10-20 6 10X8W20	MC-10-20	6	10.0	8.0	2.0 - 20.0	20.0	2003	DEC. 2003	0.0	0.0	0.0	0.0	0.0
MC-7-20 2 7X4W20	MC-7-20	2	7.0	4.0	2.0 - 20.0	20.0	2003	DEC. 2003	51.8	86.5	BIC	V	RLL
MC-8-23 3 8X7W23	MC-8-23	3	8.0	7.0	2.0 - 23.0	23.0	2003	DEC. 2003	39.8	66.5	WEM	M	TL
MC-4-23 2 4X4W23	MC-4-23	2	4.0	4.0	0.0 - 23.0	23.0	2003	DEC. 2003	117.5	196.1	WEM	M	TL
MC-9-23 5 9X9W23	MC-9-23	5	9.0	9.0	2.0 - 23.0	23.0	2003	DEC. 2003	0.0	0.0	0.0	0.0	0.0
MC-10-23 3 10X8W23	MC-10-23	3	10.0	8.0	2.0 - 23.0	23.0	2003	DEC. 2003	48.6	81.2	BIC	V	TL
MC-9-23 6 9X7W23	MC-9-23	6	9.0	7.0	2.0 - 23.0	23.0	2003	DEC. 2003	0.0	0.0	0.0	0.0	0.0
MC-8-23 4 8X5W23	MC-8-23	4	8.0	5.0	2.0 - 23.0	23.0	2003	DEC. 2003	78.9	131.7	BIC	V	RLL
MC-10-23 4 10X6W23	MC-10-23	4	10.0	6.0	2.0 - 23.0	23.0	2003	DEC. 2003	51.5	86.0	BIC	V	TL

APPENDIX TABLE 14. 2003 ERA RISA-2D WITH SPRINGS LOAD RATINGS

ID	RISA-2D SPG K=75PCI					RISA-2D SPG K=150PCI					RISA-2D SPG K=250PCI				
	IR (HS-)	OR (HS-)	CCS	CFM	LC	IR (HS-)	OR (HS-)	CCS	CFM	LC	IR (HS-)	OR (HS-)	CCS	CFM	LC
MC-10-7 3 10X8W7	25.5	42.5	WEM	M	TL	23.6	39.5	WEM	M	TL	21.9	36.5	WEM	M	TL
MC-10-7 4 10X6W7	31.3	52.2	TIC	V	RLL	31.2	52.1	TIC	V	RLL	31.3	52.2	TIC	V	RLL
MC-9-10 2 9X6W10	33.7	56.2	TIC	V	RLL	34.1	57.0	TIC	V	RLL	34.7	57.8	TIC	V	RLL
MC-7-10 5 7X7W10	24.3	40.6	WEM	M	TL	23.5	39.2	WEM	M	TL	22.5	37.6	WEM	M	TL
MC-7-10 6 7X5W10	52.6	87.7	TIC	V	RLL	52.3	87.2	TIC	V	RLL	52.3	87.4	TIC	V	RLL
MC-10-10 2 10X5W10	42.9	71.7	TIC	V	RLL	43.2	72.2	TIC	V	RLL	43.7	72.9	TIC	V	RLL
MC-7-16 3 7X6W16	55.1	92.0	WEM	M	TL	53.8	89.9	WEM	M	TL	52.2	87.1	WEM	M	TL
MC-7-16 4 7X4W16	58.3	97.4	TIC	V	RLL	58.3	97.3	TIC	V	RLL	58.7	98.0	TIC	V	RLL
MC-5-20 2 5X3W20	63.6	106.2	TIC	V	RLL	63.9	106.7	TIC	V	RLL	64.5	107.7	TIC	V	RLL
MC-8-20 6 8X6W20	63.1	105.3	TIC	V	RLL	63.3	105.7	TIC	V	RLL	63.9	106.7	TIC	V	RLL
MC-8-20 5 8X8W20	-18.2	-30.4	WEM	M	TL	-19.1	-32.0	WEM	M	TL	-20.3	-33.9	WEM	M	TL
MC-10-20 5 10X10W20	-30.1	-50.3	WEM	M	TL	-31.4	-52.5	WEM	M	TL	-33.1	-55.2	WEM	M	TL
MC-10-20 6 10X8W20	51.7	86.3	WEM	M	TL	49.1	82.0	WEM	M	TL	46.9	78.2	WEM	M	TL
MC-7-20 2 7X4W20	55.9	93.3	TIC	V	RLL	56.7	94.7	TIC	V	RLL	57.3	95.6	TIC	V	RLL
MC-8-23 3 8X7W23	36.8	61.5	WEM	M	TL	35.6	59.4	WEM	M	TL	34.1	56.9	WEM	M	TL
MC-4-23 2 4X4W23	21.1	35.2	BIC	V	RLL	22.6	37.6	BIC	V	RLL	24.2	40.4	BIC	V	RLL
MC-9-23 5 9X9W23	-21.6	-36.0	WEM	M	TL	-22.7	-37.8	WEM	M	TL	-24.0	-40.1	WEM	M	TL
MC-10-23 3 10X8W23	63.2	105.5	WEM	M	TL	60.9	101.7	WEM	M	TL	58.3	97.4	WEM	M	TL
MC-9-23 6 9X7W23	78.3	130.7	TIC	V	RLL	78.0	130.3	TIC	V	RLL	77.2	128.9	WEM	M	TL
MC-8-23 4 8X5W23	81.5	136.0	TIC	V	RLL	82.4	137.6	TIC	V	RLL	83.0	138.6	TIC	V	RLL
MC-10-23 4 10X6W23	62.8	104.8	TIC	V	RLL	64.0	106.8	TIC	V	RLL	65.3	109.0	TIC	V	RLL

APPENDIX TABLE 15. 2003 ERA RISA-2D WITH LEFE LOAD RATINGS

ID	RISA-2D LEFE E=8KSI				RISA-2D LEFE E=20KSI				RISA-2D LEFE E=36KSI			
	IR (HS-)	OR (HS-)	CCS	CFM	IR (HS-)	OR (HS-)	CCS	CFM	IR (HS-)	OR (HS-)	CCS	CFM
MC-10-7 3 10X8W7	12.1	20.2	WBEC	M	57.9	96.6	TIC	V	68.9	115.0	TIC	V
MC-10-7 4 10X6W7	41.3	68.9	WBEC	M	58.7	98.0	TIC	V	69.4	115.9	TIC	V
MC-9-10 2 9X6W10	30.4	50.7	BIC	V	48.0	80.2	BIC	V	64.5	107.6	BIC	V
MC-7-10 5 7X7W10	13.7	22.8	WBEC	M	51.6	86.2	BEC	V	68.4	114.2	BIC	V
MC-7-10 6 7X5W10	44.3	74.0	TIC	V	61.4	102.5	BIC	V	73.4	122.6	BIC	V
MC-10-10 2 10X5W10	40.9	68.3	BIC	V	58.1	96.9	BIC	V	74.2	123.8	BIC	V
MC-7-16 3 7X6W16	35.4	59.1	WBEC	M	84.6	141.3	WBEC	M	138.1	230.5	WBEC	M
MC-7-16 4 7X4W16	51.7	86.3	WTIC	M	130.9	218.6	WTIC	M	211.9	353.7	BIC	V
MC-5-20 2 5X3W20	41.9	70.0	TIC	V	79.7	133.1	TIC	V	127.6	213.0	TIC	V
MC-8-20 6 8X6W20	18.7	31.2	WTIC	M	80.0	133.6	WBEC	M	144.3	240.9	WBEC	M
MC-8-20 5 8X8W20	8.5	14.1	WTIC	M	91.4	152.6	WBEC	M	166.2	277.5	WBEC	M
MC-10-20 5 10X10W20	-24.3	-40.6	WTIC	M	71.7	119.6	WTIC	M	173.5	289.6	WTIC	M
MC-10-20 6 10X8W20	-13.2	-22.0	WTIC	M	87.6	146.3	WTIC	M	190.4	317.8	WTIC	M
MC-7-20 2 7X4W20	57.6	96.1	TIC	V	118.4	197.7	TIC	V	192.0	320.5	BIC	V
MC-8-23 3 8X7W23	0.2	0.4	WBEC	M	49.8	83.1	WBEC	M	105.7	176.4	WBEC	M
MC-4-23 2 4X4W23	49.4	82.4	TIC	V	78.1	130.3	TIC	V	113.9	190.1	TIC	V
MC-9-23 5 9X9W23	-16.5	-27.6	WTIC	M	70.8	118.2	WTIC	M	162.4	271.1	WTIC	M
MC-10-23 3 10X8W23	11.1	18.5	WTIC	M	90.3	150.7	WTIC	M	176.8	295.1	WTIC	M
MC-9-23 6 9X7W23	-8.8	-14.7	WTIC	M	89.6	149.6	WTIC	M	189.2	315.9	WTIC	M
MC-8-23 4 8X5W23	30.1	50.3	WTIC	M	117.6	196.4	WTIC	M	201.0	335.6	WBEC	M
MC-10-23 4 10X6W23	3.1	5.2	WTIC	M	106.1	177.2	WTIC	M	206.9	345.4	WTIC	M

**APPENDIX F**  
**SOIL BORING LOGS**



**CLIENT** Texas Department of Transportation      **PROJECT NAME** Culvert 0052-07-010, US Hwy 84  
**PROJECT NUMBER** 0-5849 (culvert loading)      **PROJECT LOCATION** Shallowater, Lubbock County, TX  
**DATE STARTED** 5/12/09      **COMPLETED** 5/12/09      **GROUND ELEVATION** \_\_\_\_\_      **HOLE SIZE** 4 inches  
**DRILLING CONTRACTOR** W.E.S.T Drilling      **GROUND WATER LEVELS:**  
**DRILLING METHOD** Hollow Stem Auger      **AT TIME OF DRILLING** ---  
**LOGGED BY** PWJ      **CHECKED BY** WDL      **AT END OF DRILLING** ---  
**NOTES** \_\_\_\_\_      **AFTER DRILLING** ---

GENERAL BH / TP / WELL - GINT STD US LAB.GDT - 9/22/09 15:14 - E:\TXDOT\CULVERT\CULVERT BORING LOGS\SWUS84.GPJ

DEPTH (ft)	SAMPLE TYPE	RECOVERY %	BLOW COUNTS (N VALUE)	REMARKS	U.S.C.S.	GRAPHIC LOG	MATERIAL DESCRIPTION
0.0							
	ST	44				[Cross-hatched pattern]	(SC) FILL: CLAYEY SAND, reddish tan, w/ calcareous inclusions
2.5	ST	33		PP = 4.5+ tsf	SC		
	SPT	0	5-3-4 (7)				
4.5							
5.0	ST	83		PP = 3.5 tsf		[Cross-hatched pattern]	(SC) FILL: CLAYEY SAND, brown, w/ calcareous gravel, asphalt
	ST	75		PP = 4.5+ tsf (-)200 = 27%			
	ST	75					
7.5	ST	75		PP = 4.5+ tsf	SC		
	SPT	100	3-3-2 (5)	PP = 4.5+ tsf			
10.0							
10.5	ST	78		PP = 4.5+ tsf MC = 14% LL = 34 PL = 12 (-)200 = 34%	SC	[Diagonal hatching]	(SC) CLAYEY SAND: reddish tan, silty
12.0	ST	56				[Diagonal hatching]	(SC) CLAYEY SAND: light grey
12.5							
	SPT	100	12-23-30 (53)	PP = 4.5+ tsf MC = 14% (-)200 = 35%	SC	[Diagonal hatching]	
14.5							

Bottom of borehole at 14.5 feet.





<b>CLIENT</b> <u>Texas Department of Transportation</u>	<b>PROJECT NAME</b> <u>Culvert 0052-07-010, US Hwy 84</u>
<b>PROJECT NUMBER</b> <u>0-5849 (culvert loading)</u>	<b>PROJECT LOCATION</b> <u>Shallowater, Lubbock County, TX</u>
<b>DATE STARTED</b> <u>5/12/09</u> <b>COMPLETED</b> <u>5/12/09</u>	<b>GROUND ELEVATION</b> _____ <b>HOLE SIZE</b> <u>4 inches</u>
<b>DRILLING CONTRACTOR</b> <u>W.E.S.T Drilling</u>	<b>GROUND WATER LEVELS:</b>
<b>DRILLING METHOD</b> <u>Hollow Stem Auger</u>	<b>AT TIME OF DRILLING</b> <u>---</u>
<b>LOGGED BY</b> <u>PWJ</u> <b>CHECKED BY</b> <u>WDL</u>	<b>AT END OF DRILLING</b> <u>---</u>
<b>NOTES</b> _____	<b>AFTER DRILLING</b> <u>---</u>

DEPTH (ft)	SAMPLE TYPE	BLOW COUNTS (N VALUE)	U.S.C.S.	GRAPHIC LOG	MATERIAL DESCRIPTION
0.0					
2.5	DCP	20-30/0"	SC		(SC) FILL: CLAYEY SAND; reddish brown, w/ calcareous gravel pieces
	TCP	8-6			
4.5					(SC) FILL: CLAYEY SAND ; Reddish- brown, w/ calcareous gravel and asphalt pieces
7.5	DCP	10-22-20/0"	SC		
	TCP	9-10			
11.0					(SC) CLAYEY SAND: brown
12.5	DCP	7-12-11/0"	SC		
	TCP	6-5			
14.5					

GENERAL BH / TP / WELL - GINT STD US LAB.GDT - 9/22/09 15:14 - E:\TXDOT\CULVERT\CULVERT BORING LOGS\SWUS84.GPJ

Bottom of borehole at 14.5 feet.



<b>CLIENT</b> Texas Department of Transportation	<b>PROJECT NAME</b> Culvert 0439-05-025 SH194
<b>PROJECT NUMBER</b> 0-5849 ( culvert loading)	<b>PROJECT LOCATION</b> Plainview, Hale County, TX
<b>DATE STARTED</b> 5/13/09 <b>COMPLETED</b> 5/13/09	<b>GROUND ELEVATION</b> _____ <b>HOLE SIZE</b> 4 inches
<b>DRILLING CONTRACTOR</b> W.E.S.T Drilling	<b>GROUND WATER LEVELS:</b>
<b>DRILLING METHOD</b> Hollow Stem Auger	<b>AT TIME OF DRILLING</b> ---
<b>LOGGED BY</b> PWJ <b>CHECKED BY</b> WDL	<b>AT END OF DRILLING</b> ---
<b>NOTES</b> _____	<b>AFTER DRILLING</b> ---

DEPTH (ft)	SAMPLE TYPE	RECOVERY %	BLOW COUNTS (N VALUE)	REMARKS	U.S.C.S.	GRAPHIC LOG	MATERIAL DESCRIPTION
0.0							
	NR						PAVEMENT: 4" asphalt over base
							1.0
							(CL-CH) FILL: LEAN/ FAT SANDY CLAY, Dark brown
2.5	ST	83					
	SPT	100	3-5-7 (12)	PP = 3.75 tsf			
5.0	ST	61		PP = 1.0 tsf	CL-CH		
	ST	78		PP = 2.0 tsf MC = 20%			
7.5	ST	75		PP = 1.0 tsf			
	SPT	100	3-2-3 (5)				
10.0	ST	78		PP = 1.5 tsf			10.5
					SP		(SP) SAND, Brown& Tan, silty
12.5	ST	56		PP = 1.75 tsf MC = 15% (-200) = 31%			12.5
					GC		(GC) CLAYEY GRAVEL: light tan, calcareous
	SPT	100	6-8-8 (16)				13.5
					SW		(SW) SAND: light tan, w/ calcareous gravel
							14.5

Bottom of borehole at 14.5 feet.

GENERAL BH / TP / WELL - GINT STD US LAB.GDT - 9/22/09 15:27 - E:\TXDOT\CULVERT\CULVERT BORING LOGS\IPVSH194.GPJ



<b>CLIENT</b> <u>Texas Department of Transportation</u>	<b>PROJECT NAME</b> <u>Culvert 0439-05-025 SH194</u>
<b>PROJECT NUMBER</b> <u>0-5849 ( culvert loading)</u>	<b>PROJECT LOCATION</b> <u>Plainview, Hale County, TX</u>
<b>DATE STARTED</b> <u>5/13/09</u> <b>COMPLETED</b> <u>5/13/09</u>	<b>GROUND ELEVATION</b> _____ <b>HOLE SIZE</b> <u>4 inches</u>
<b>DRILLING CONTRACTOR</b> <u>W.E.S.T Drilling</u>	<b>GROUND WATER LEVELS:</b>
<b>DRILLING METHOD</b> <u>Hollow Stem Auger</u>	<b>AT TIME OF DRILLING</b> ---
<b>LOGGED BY</b> <u>PWJ</u> <b>CHECKED BY</b> <u>WDL</u>	<b>AT END OF DRILLING</b> ---
<b>NOTES</b> _____	<b>AFTER DRILLING</b> ---

DEPTH (ft)	SAMPLE TYPE	RECOVERY %	BLOW COUNTS (N VALUE)	REMARKS	U.S.C.S.	GRAPHIC LOG	MATERIAL DESCRIPTION
0.0							
	NR						PAVEMENT: 4" asphalt over base
							1.0
							(CL-CH) FILL: LEAN/FAT SANDY CLAY; Dark Brown, w/ occasional sand seams, occasional calcareous gravel
2.5	ST	67		PP = 4.5+ tsf			
	SPT	100	5-5-9 (14)				
5.0	ST	61		PP = 4.5+ tsf			
	ST	61		PP = 4.5+ tsf MC = 16% LL = 42 PL = 13 (-200) = 60%	CL-CH		
7.5	ST	83					
	SPT	100	3-4-4 (8)	PP = 4.5+ tsf			
10.0	ST	89		PP = 3.5 tsf MC = 17% LL = 34 PL = 12 (-200) = 66%			10.5
	ST	78		PP = 4.5+ tsf	CL		(CL) SANDY LEAN CLAY: Brown, silty
12.5	SPT	100	8-12-15 (27)				
							14.0
					SW		(SW) SAND : Tan
							14.5

Bottom of borehole at 14.5 feet.



CLIENT Texas Department of Transportation  
 PROJECT NUMBER 0-5849 ( culvert loading)  
 DATE STARTED 5/13/09 COMPLETED 5/13/09  
 DRILLING CONTRACTOR W.E.S.T Drilling  
 DRILLING METHOD Hollow Stem Auger  
 LOGGED BY PWJ CHECKED BY WDL  
 NOTES \_\_\_\_\_

PROJECT NAME Culvert 0439-05-025 SH194  
 PROJECT LOCATION Plainview, Hale County, TX  
 GROUND ELEVATION \_\_\_\_\_ HOLE SIZE 4 inches  
 GROUND WATER LEVELS:  
 AT TIME OF DRILLING ---  
 AT END OF DRILLING ---  
 AFTER DRILLING ---

DEPTH (ft)	SAMPLE TYPE	BLOW COUNTS (N VALUE)	U.S.C.S.	GRAPHIC LOG	MATERIAL DESCRIPTION
0.0					
					PAVEMENT: 4" asphalt over base
1.0					
			CL-CH		(CL-CH) FILL: LEAN/FAT SANDY CLAY; Dark Brown, w/ occasional sand seams, occasional calcareous gravel
2.5	DCP	4-4-8/0"			
	TCP	9-9			
5.0					
	DCP	9-24-27/0"			
7.5					
	TCP	7-6			
10.0					
	DCP	6-21-25/0"	CL		(CL) SANDY CLAY: Brown, silty
12.5					
	TCP	32-4			
14.0			SW		(SW) SAND : Tan
14.5					

GENERAL BH / TP / WELL - GINT STD US LAB.GDT - 9/22/09 15:27 - E:\TXDOT\CULVERT\CULVERT BORING LOGS\IPVSH194.GPJ

Bottom of borehole at 14.5 feet.



<b>CLIENT</b> Texas Department of Transportation	<b>PROJECT NAME</b> Culvert 1345-01-002 FM 1318
<b>PROJECT NUMBER</b> 0-5849 (culvert loading)	<b>PROJECT LOCATION</b> Tulia, Swisher county, TX
<b>DATE STARTED</b> 5/14/09 <b>COMPLETED</b> 5/14/09	<b>GROUND ELEVATION</b> _____ <b>HOLE SIZE</b> 4 inches
<b>DRILLING CONTRACTOR</b> W.E.S.T Drilling	<b>GROUND WATER LEVELS:</b>
<b>DRILLING METHOD</b> _____	▽ <b>AT TIME OF DRILLING</b> 9.50 ft
<b>LOGGED BY</b> TAW <b>CHECKED BY</b> WDL	<b>AT END OF DRILLING</b> ---
<b>NOTES</b> _____	<b>AFTER DRILLING</b> ---

DEPTH (ft)	SAMPLE TYPE	RECOVERY %	BLOW COUNTS (N VALUE)	REMARKS	U.S.C.S.	GRAPHIC LOG	MATERIAL DESCRIPTION
0.0							
	NR						PAVEMENT: Multiple seal coats over gravel base
							1.0
							(SC/CL) FILL: CLAYEY SAND/ SANDY CLAY; brown, w/ gravel
2.5	ST	33		PP = 4.5+ tsf			
	SPT	100	3-2-2 (4)				
					SC/CL		
5.0	ST	44		PP = 4.5+ tsf			
	ST	39		MC = 15% LL = 29 PL = 12 (-)200 = 38%			
7.5	ST	100					8.0
					SC		(SC) CLAYEY SAND: Brown
	SPT	100	1-4-4 (8)				9.0
							▽ (SP) POORLY GRADED (FINE) SAND: Tan, silty
10.0	ST	92					
	ST	100					
					SP		
12.5	DS	100		MC = 7% (-)200 = 11%			
	SPT	100	7-11-11 (22)				
							14.5

GENERAL BH / TP / WELL - GINT STD US LAB.GDT - 9/22/09 15:56 - E:\TXDOT\CULVERT\CULVERT BORING LOGSTUFM1318.GPJ

Bottom of borehole at 14.5 feet.

<b>CLIENT</b> Texas Department of Transportation	<b>PROJECT NAME</b> Culvert 1345-01-002 FM 1318
<b>PROJECT NUMBER</b> 0-5849 (culvert loading)	<b>PROJECT LOCATION</b> Tulia, Swisher county, TX
<b>DATE STARTED</b> 5/14/09 <b>COMPLETED</b> 5/14/09	<b>GROUND ELEVATION</b> _____ <b>HOLE SIZE</b> 4 inches
<b>DRILLING CONTRACTOR</b> W.E.S.T Drilling	<b>GROUND WATER LEVELS:</b>
<b>DRILLING METHOD</b> _____	▽ <b>AT TIME OF DRILLING</b> 9.00 ft
<b>LOGGED BY</b> TAW <b>CHECKED BY</b> WDL	<b>AT END OF DRILLING</b> ---
<b>NOTES</b> _____	<b>AFTER DRILLING</b> ---

DEPTH (ft)	SAMPLE TYPE	RECOVERY %	BLOW COUNTS (N VALUE)	REMARKS	U.S.C.S.	GRAPHIC LOG	MATERIAL DESCRIPTION
0.0	NR						PAVEMENT: Multiple seal coats over gravel base
1.0							(SC/CL) FILL: CLAYEY SAND/ SANDY CLAY, Brown, w/ gravel
2.5	ST	67					
3.5	SPT	100	2-1-2 (3)	PP = 4.5+ tsf	SC/CL		
5.0	ST	56		PP = 0.5 tsf MC = 16% LL = 31 PL = 11 (-)200 = 36%			
6.5	ST	67		PP = 1.5 tsf			
7.5	ST	75			SC		(SC) CLAYEY SAND; Grayish tan
8.0							(SW) SAND: Tan, fine
9.0	SPT	100	3-4-8 (12)	PP = 0.5 tsf MC = 9% (-)200 = 11%	SW		▽
10.0	ST	100					
11.0	DS	100					
12.5	DS	100		MC = 8% (-)200 = 16%			(GW/SW) GRAVEL& SAND: Tan
13.5	SPT	100	23-16-13 (29)		GW/SW		
14.5							

Bottom of borehole at 14.5 feet.

<b>CLIENT</b> <u>Texas Department of Transportation</u>	<b>PROJECT NAME</b> <u>Culvert 1345-01-002 FM 1318</u>
<b>PROJECT NUMBER</b> <u>0-5849 (culvert loading)</u>	<b>PROJECT LOCATION</b> <u>Tulia, Swisher county, TX</u>
<b>DATE STARTED</b> <u>5/14/09</u> <b>COMPLETED</b> <u>5/14/09</u>	<b>GROUND ELEVATION</b> _____ <b>HOLE SIZE</b> <u>4 inches</u>
<b>DRILLING CONTRACTOR</b> <u>W.E.S.T Drilling</u>	<b>GROUND WATER LEVELS:</b>
<b>DRILLING METHOD</b> _____	<b>AT TIME OF DRILLING</b> <u>---</u>
<b>LOGGED BY</b> <u>TAW</u> <b>CHECKED BY</b> <u>WDL</u>	<b>AT END OF DRILLING</b> <u>---</u>
<b>NOTES</b> _____	<b>AFTER DRILLING</b> <u>---</u>

DEPTH (ft)	SAMPLE TYPE	BLOW COUNTS (N VALUE)	U.S.C.S.	GRAPHIC LOG	MATERIAL DESCRIPTION
0.0					
					PAVEMENT: Multiple seal coats over gravel base
1.0					(SC/CL) FILL: CLAYEY SAND/ SANDY CLAY, Brown, w/ gravel
2.5	DCP	8-21-15/0"	SC/CL		
5.0	TCP	2-4	SC		(SC) CLAYEY SAND; Grayish tan
7.5	DCP	7-11-10/0"	SC		(SW) SAND: Tan, fine
10.0	TCP	2-11	SW		
11.5	DCP	14-30/0"	GW/SW		(GW/SW) GRAVEL & SAND: Tan
12.5	TCP	41-50	GW/SW		
14.5					

GENERAL BH / TP / WELL - GINT STD US LAB.GDT - 9/22/09 15:56 - E:\TXDOT\CULVERT\CULVERT BORING LOGSTUFM1318.GPJ

Bottom of borehole at 14.5 feet.



**APPENDIX G**  
**FWD DATA**

US84 EB Approach.asc

TTI MODULUS ANALYSIS SYSTEM (SUMMARY REPORT)

(Version 6.0)

District:5 (Lubbock)  
 County :152 (LUBBOCK)  
 Highway/Road: US0084

	Thickness(in)	MODULI RANGE(psi)		Poisson Ratio Values	
Pavement:	6.00	Minimum	Maximum	H1: v =	0.38
Base:	10.00	50,000	300,000	H2: v =	0.35
Subbase:	0.00	10,000	1,000,000	H3: v =	0.00
Subgrade:	67.24(by DB)	15,000		H4: v =	0.40

Station	Load (lbs)	Measured Deflection (mils):							Calculated Moduli values (ksi):				Absolute Dpth to	
		R1	R2	R3	R4	R5	R6	R7	SURF(E1)	BASE(E2)	SUBB(E3)	SUBG(E4)	ERR/Sens	Bedrock
0.000	8,933	8.73	5.09	3.43	2.44	1.60	1.39	1.11	112.8	729.2	0.0	11.3	8.85	86.9
0.000	8,901	8.64	5.06	3.42	2.43	1.58	1.39	1.09	115.1	720.5	0.0	11.3	8.96	84.7
11.000	8,862	8.54	4.81	3.28	2.35	1.51	1.34	1.11	106.9	828.4	0.0	11.8	8.92	81.1
21.000	8,925	8.68	4.96	3.31	2.34	1.56	1.37	1.12	107.5	793.9	0.0	11.7	9.41	91.8
32.000	8,874	9.04	4.82	3.20	2.30	1.48	1.32	1.04	91.8	874.1	0.0	12.4	9.66	80.9
41.000	8,886	8.86	4.59	3.09	2.20	1.44	1.26	0.98	90.3	957.5	0.0	12.9	9.26	85.4
54.000	8,854	8.81	5.01	3.43	2.42	1.56	1.36	1.07	106.9	742.6	0.0	11.5	8.63	83.4
63.000	8,850	8.27	4.72	3.19	2.30	1.49	1.31	1.03	111.9	842.1	0.0	12.0	8.91	82.1
72.000	8,901	7.96	4.66	3.11	2.21	1.44	1.27	1.01	124.9	766.5	0.0	12.5	9.25	83.5
82.000	8,894	8.33	4.64	3.09	2.22	1.44	1.27	1.01	107.3	861.9	0.0	12.7	9.34	82.0
92.000	8,894	8.42	4.74	3.20	2.30	1.48	1.35	1.06	107.7	863.7	0.0	12.1	9.56	80.7
102.000	8,945	8.34	4.91	3.39	2.45	1.62	1.44	1.15	116.7	869.7	0.0	11.0	8.69	88.7
111.000	8,838	8.67	4.88	3.28	2.37	1.57	1.39	1.12	102.1	885.2	0.0	11.5	9.27	88.7
121.000	8,945	8.85	4.85	3.19	2.30	1.52	1.35	1.07	97.2	889.1	0.0	12.2	9.81	87.2
131.000	8,862	7.93	4.61	3.05	2.18	1.43	1.29	1.06	120.2	828.9	0.0	12.5	9.82	84.6
143.000	8,905	9.30	5.00	3.27	2.33	1.49	1.32	1.08	92.1	767.5	0.0	12.4	9.84	79.9
154.000	8,866	9.34	5.00	3.17	2.23	1.43	1.26	1.01	92.0	690.1	0.0	13.1	10.41	80.3
162.000	8,830	8.91	4.89	3.16	2.22	1.43	1.31	0.99	97.8	755.0	0.0	12.7	10.68	81.5
173.000	8,882	8.37	5.00	3.16	2.25	1.48	1.27	0.93	126.6	604.2	0.0	12.5	9.79	85.2
181.000	8,933	8.67	5.13	3.36	2.33	1.50	1.30	1.02	124.5	565.8	0.0	12.2	9.32	82.4
193.000	8,981	7.87	5.06	3.30	2.30	1.52	1.34	1.07	172.4	507.8	0.0	11.8	9.50	88.3
202.000	8,941	8.54	5.02	3.28	2.30	1.46	1.27	1.03	125.0	583.0	0.0	12.5	9.32	78.5
215.000	8,901	10.20	5.43	3.53	2.41	1.56	1.32	1.01	86.0	599.8	0.0	12.1	9.52	85.9
221.000	8,977	10.13	5.36	3.41	2.37	1.55	1.31	1.02	84.6	649.4	0.0	12.4	9.88	86.8
230.000	8,957	9.63	5.13	3.30	2.30	1.44	1.26	1.04	91.5	637.9	0.0	13.0	9.96	76.5
240.000	9,040	8.39	4.74	3.08	2.15	1.32	1.15	0.93	121.9	600.5	0.0	14.0	9.40	72.1
252.000	8,929	8.87	5.20	3.46	2.39	1.53	1.33	1.11	119.2	576.4	0.0	11.8	9.11	82.0
265.000	8,874	8.47	5.13	3.53	2.55	1.66	1.46	1.19	123.9	728.7	0.0	10.5	8.42	84.8
276.000	8,878	8.57	4.98	3.41	2.47	1.62	1.45	1.17	110.2	851.2	0.0	10.9	8.95	86.3
285.000	8,949	9.30	5.47	3.43	2.40	1.56	1.37	1.11	113.6	523.8	0.0	11.9	10.36	84.0
295.000	8,965	8.02	4.78	3.19	2.33	1.53	1.38	1.12	124.5	841.6	0.0	11.7	9.47	84.3
312.000	8,909	11.80	6.87	4.27	2.91	1.81	1.54	1.17	98.5	307.3	0.0	10.3	9.78	78.4
323.000	8,909	13.31	8.00	4.90	3.29	2.00	1.66	1.28	114.3	179.6	0.0	9.2	9.08	76.0
333.000	8,929	11.19	6.78	4.23	2.89	1.81	1.53	1.14	121.8	273.4	0.0	10.2	9.38	79.3
355.000	8,957	9.64	5.50	3.60	2.53	1.63	1.38	1.02	102.4	585.7	0.0	11.4	9.02	83.2
Mean:		9.05	5.17	3.39	2.39	1.54	1.35	1.07	110.3	693.8	0.0	11.9	9.41	83.2
Std. Dev:		1.13	0.70	0.37	0.23	0.13	0.09	0.07	16.6	183.0	0.0	0.9	0.51	4.1
Var Coeff(%):		12.50	13.50	11.02	9.44	8.24	7.02	6.89	15.0	26.4	0.0	7.8	5.37	5.0

US84 WB Approach.asc

TTI MODULUS ANALYSIS SYSTEM (SUMMARY REPORT)

(Version 6.0)

District:5 (Lubbock)  
 County :152 (LUBBOCK)  
 Highway/Road: US0084

	Thickness(in)	MODULI RANGE(psi)		Poisson Ratio Values
		Minimum	Maximum	
Pavement:	6.00	50,000	300,000	H1: v = 0.38
Base:	10.00	10,000	1,000,000	H2: v = 0.35
Subbase:	0.00			H3: v = 0.00
Subgrade:	66.49(by DB)	15,000		H4: v = 0.40

Station	Load (lbs)	Measured Deflection (mils):							Calculated Moduli values (ksi):				Absolute Dpth to	
		R1	R2	R3	R4	R5	R6	R7	SURF(E1)	BASE(E2)	SUBB(E3)	SUBG(E4)	ERR/Sens	Bedrock
0.000	9,247	14.15	8.35	4.51	2.93	1.81	1.57	1.27	140.4	106.3	0.0	10.6	11.12	76.0
13.000	9,259	13.57	7.76	4.07	2.57	1.59	1.37	1.10	136.3	107.1	0.0	12.2	11.89	75.9
25.000	9,144	10.42	6.02	3.36	2.21	1.38	1.20	0.98	156.1	185.1	0.0	14.1	11.02	75.5
37.000	9,203	9.26	5.26	3.42	2.45	1.59	1.43	1.16	102.8	748.8	0.0	11.7	10.13	82.8
47.000	9,144	11.15	6.19	3.75	2.65	1.74	1.55	1.17	82.9	549.8	0.0	11.1	11.46	87.1
52.000	9,076	14.95	8.47	4.73	3.16	1.93	1.73	1.36	97.2	144.2	0.0	9.9	11.46	74.9
61.000	9,080	15.29	7.91	4.29	2.89	1.86	1.64	1.32	64.1	232.9	0.0	10.9	12.92	84.1
74.000	9,033	14.31	8.40	4.76	3.26	2.09	1.82	1.43	92.5	195.5	0.0	9.3	11.51	83.5
82.000	9,025	14.97	8.52	4.71	3.17	1.99	1.76	1.41	92.9	153.5	0.0	9.8	11.68	79.2
94.000	9,080	14.74	8.18	4.41	2.88	1.84	1.60	1.26	100.1	130.7	0.0	10.8	12.53	83.0
102.000	9,017	15.22	8.27	4.14	2.63	1.63	1.41	1.11	107.1	91.9	0.0	11.9	13.31	75.9
112.000	9,092	13.76	7.22	3.54	2.27	1.41	1.26	1.03	109.8	106.7	0.0	14.0	14.32	74.5
123.000	9,033	13.98	7.78	3.83	2.41	1.51	1.34	1.11	129.9	89.8	0.0	12.8	13.91	76.9
133.000	9,005	15.85	8.35	4.07	2.52	1.59	1.37	1.09	102.1	80.9	0.0	12.4	14.31	79.5
149.000	8,973	14.48	7.87	3.89	2.50	1.59	1.38	1.11	109.3	99.5	0.0	12.4	14.23	79.6
157.000	8,945	15.17	8.23	4.00	2.53	1.61	1.38	1.12	110.6	84.7	0.0	12.2	14.41	80.2
163.000	8,973	15.07	8.46	4.07	2.52	1.60	1.32	1.06	131.2	72.2	0.0	12.2	13.91	79.9
178.000	8,957	13.82	7.66	3.81	2.40	1.45	1.33	1.23	130.9	89.4	0.0	12.9	13.17	71.3
186.000	8,973	14.00	7.83	3.87	2.54	1.71	1.50	1.19	112.0	114.0	0.0	11.9	15.49	94.7
193.000	8,977	14.90	8.09	3.98	2.63	1.75	1.62	1.30	95.7	115.9	0.0	11.6	15.99	186.6
205.000	8,945	15.12	8.06	3.98	2.65	1.74	1.60	1.23	90.9	116.4	0.0	11.6	15.72	197.6
210.000	9,017	10.57	5.99	3.58	2.55	1.61	1.49	1.34	92.5	491.5	0.0	11.6	11.96	76.7
225.000	9,005	10.26	5.88	3.43	2.38	1.57	1.44	1.22	97.6	469.2	0.0	12.2	12.55	87.2
230.000	8,993	10.95	6.30	3.74	2.64	1.74	1.57	1.30	90.0	476.9	0.0	10.9	11.94	87.8
244.000	8,949	11.63	6.66	3.61	2.44	1.61	1.48	1.28	109.2	227.5	0.0	12.3	13.35	87.8
251.000	8,969	11.67	6.26	3.51	2.38	1.56	1.42	1.23	80.6	373.6	0.0	12.6	13.13	86.6
264.000	8,981	10.51	6.08	3.35	2.27	1.53	1.40	1.19	109.1	320.6	0.0	12.9	13.25	94.1
271.000	8,929	11.75	6.48	3.44	2.29	1.50	1.39	1.17	109.6	194.8	0.0	13.3	14.06	85.6
281.000	8,921	12.20	6.40	3.39	2.28	1.49	1.38	1.15	82.1	266.5	0.0	13.4	14.20	84.8
291.000	8,866	12.19	6.61	3.52	2.33	1.55	1.44	1.20	94.6	215.6	0.0	12.9	14.43	91.3
301.000	8,909	12.49	6.80	3.52	2.36	1.58	1.47	1.24	96.4	194.2	0.0	12.9	15.22	92.1
315.000	8,917	13.69	7.40	3.98	2.48	1.63	1.48	1.24	106.6	127.2	0.0	12.0	13.69	91.8
321.000	8,937	13.59	7.61	3.96	2.52	1.66	1.48	1.26	117.3	118.2	0.0	11.8	14.01	90.2
334.000	8,929	14.22	8.05	4.04	2.55	1.65	1.53	1.29	123.1	96.7	0.0	11.7	14.54	84.6
Mean:		13.23	7.34	3.89	2.57	1.65	1.48	1.21	106.0	211.4	0.0	12.0	13.26	82.5
Std. Dev:		1.83	0.96	0.40	0.26	0.16	0.14	0.10	19.1	162.8	0.0	1.1	1.46	13.1
Var Coeff(%):		13.80	13.11	10.40	10.27	9.65	9.38	8.65	18.0	77.0	0.0	9.3	11.05	15.8

US84 EB Departure.asc

TTI MODULUS ANALYSIS SYSTEM (SUMMARY REPORT)

(Version 6.0)

District:5 (Lubbock)  
 County :152 (LUBBOCK)  
 Highway/Road: US0084

	Thickness(in)	Minimum	Maximum	Poisson Ratio Values
Pavement:	6.00	50,000	300,000	H1: v = 0.38
Base:	10.00	10,000	1,500,000	H2: v = 0.35
Subbase:	0.00			H3: v = 0.00
Subgrade:	75.06(by DB)	15,000		H4: v = 0.40

Station	Load (lbs)	Measured Deflection (mils):							Calculated Moduli values (ksi):				Absolute Dpth to	
		R1	R2	R3	R4	R5	R6	R7	SURF(E1)	BASE(E2)	SUBB(E3)	SUBG(E4)	ERR/Sens	Bedrock
0.000	8,945	9.26	5.12	3.33	2.33	1.52	1.43	1.22	99.5	666.0	0.0	13.5	10.64	85.5
11.000	8,941	9.19	4.72	3.16	2.27	1.52	1.41	1.18	85.7	984.5	0.0	13.7	10.15	92.3
21.000	8,890	9.76	5.35	3.44	2.41	1.57	1.42	1.18	94.1	593.0	0.0	13.2	10.17	85.6
32.000	8,870	9.20	5.03	3.28	2.31	1.53	1.40	1.15	96.4	713.5	0.0	13.5	10.25	89.7
41.000	8,901	9.16	5.03	3.26	2.34	1.52	1.38	1.17	98.1	704.9	0.0	13.6	10.01	82.9
50.000	8,866	8.89	5.22	3.36	2.41	1.60	1.44	1.19	113.7	626.8	0.0	12.8	9.96	89.1
62.000	8,886	9.41	5.46	3.57	2.53	1.66	1.48	1.21	107.9	574.7	0.0	12.3	9.50	87.6
70.000	8,882	8.87	5.03	3.45	2.50	1.69	1.50	1.25	102.9	859.8	0.0	12.0	8.74	97.2
80.000	8,878	8.37	4.93	3.36	2.41	1.61	1.47	1.22	118.5	782.2	0.0	12.3	9.21	92.3
91.000	8,882	7.91	4.97	3.41	2.42	1.60	1.44	1.17	152.7	621.8	0.0	12.1	8.61	89.4
103.000	8,874	8.04	4.98	3.37	2.43	1.61	1.50	1.26	138.2	701.9	0.0	12.0	9.45	88.8
113.000	8,842	7.83	4.80	3.22	2.32	1.57	1.45	1.23	135.0	775.0	0.0	12.5	9.66	95.5
124.000	8,882	8.52	4.32	2.98	2.24	1.53	1.44	1.22	89.1	1338.6	0.0	13.4	9.68	96.5 *
132.000	8,905	7.66	4.26	2.96	2.24	1.53	1.43	1.24	111.9	1304.4	0.0	13.0	9.20	95.2 *
144.000	8,878	7.76	4.30	3.01	2.26	1.51	1.43	1.28	109.7	1266.9	0.0	13.0	9.26	88.1
152.000	8,878	7.33	4.37	3.03	2.25	1.58	1.47	1.23	128.0	1219.5	0.0	12.4	9.31	111.9
162.000	8,890	7.67	4.26	3.01	2.28	1.57	1.48	1.25	114.5	1270.1	0.0	12.7	9.00	99.5 *
173.000	8,850	7.50	4.09	2.98	2.28	1.58	1.50	1.26	119.6	1267.0	0.0	12.7	8.38	102.4 *
180.000	8,854	7.85	4.25	3.10	2.36	1.62	1.54	1.31	113.7	1222.0	0.0	12.2	8.57	99.2 *
193.000	8,854	7.91	4.47	3.22	2.44	1.67	1.57	1.32	115.4	1173.1	0.0	11.7	8.50	98.6 *
204.000	8,901	8.63	4.52	3.20	2.39	1.64	1.55	1.32	93.1	1242.3	0.0	12.4	9.14	101.1 *
215.000	8,866	7.60	4.40	3.10	2.29	1.58	1.46	1.23	119.4	1199.1	0.0	12.4	8.89	103.1
222.000	8,901	7.33	4.18	2.95	2.17	1.48	1.46	1.22	120.6	1312.3	0.0	13.1	9.90	96.8 *
232.000	8,894	7.91	4.15	2.86	2.11	1.43	1.33	1.13	100.0	1303.8	0.0	14.2	9.54	93.4
242.000	8,897	7.87	4.24	2.89	2.09	1.41	1.31	1.09	105.7	1125.8	0.0	14.4	9.75	92.9
251.000	8,897	8.57	4.34	2.94	2.13	1.46	1.33	1.10	88.9	1177.6	0.0	14.3	9.75	100.3
264.000	8,838	8.52	4.27	2.94	2.16	1.44	1.31	1.07	88.4	1199.1	0.0	14.2	9.21	88.8
277.000	8,866	8.61	4.45	3.02	2.20	1.46	1.35	1.10	91.3	1077.1	0.0	14.0	9.70	87.9
281.000	8,874	8.63	4.52	3.11	2.26	1.48	1.35	1.10	94.1	1012.9	0.0	13.7	9.13	84.8
292.000	8,858	8.32	4.57	3.12	2.26	1.49	1.32	1.09	105.3	914.6	0.0	13.6	8.74	86.6
304.000	8,854	10.35	5.82	3.65	2.50	1.59	1.39	1.15	102.6	384.0	0.0	13.1	9.75	81.1
316.000	8,894	8.24	4.86	3.31	2.35	1.52	1.36	1.12	127.8	668.0	0.0	13.1	8.70	82.9
327.000	8,858	8.24	4.74	3.12	2.16	1.38	1.22	1.01	128.5	559.3	0.0	14.7	9.13	80.0
343.000	8,878	9.51	5.44	3.61	2.44	1.50	1.30	1.04	118.2	406.7	0.0	13.5	8.49	75.8
356.000	8,842	8.74	5.36	3.61	2.47	1.59	1.31	0.99	151.2	400.0	0.0	12.7	7.36	84.5
Mean:		8.43	4.71	3.20	2.31	1.54	1.42	1.18	110.8	932.8	0.0	13.1	9.30	91.1
Std. Dev:		0.73	0.45	0.22	0.12	0.07	0.08	0.09	17.3	311.2	0.0	0.8	0.66	7.5
Var Coeff(%):		8.69	9.64	6.99	5.08	4.85	5.73	7.23	15.6	33.4	0.0	5.9	7.12	8.2

US84 WB Departure.asc

TTI MODULUS ANALYSIS SYSTEM (SUMMARY REPORT)

(Version 6.0)

District:5 (Lubbock)  
 County :152 (LUBBOCK)  
 Highway/Road: US0084

	Thickness(in)	Minimum	Maximum	Poisson Ratio Values
Pavement:	6.00	50,000	300,000	H1: v = 0.38
Base:	10.00	10,000	1,000,000	H2: v = 0.35
Subbase:	0.00			H3: v = 0.00
Subgrade:	74.37(by DB)		15,000	H4: v = 0.40

Station	Load (lbs)	Measured Deflection (mils):							Calculated Moduli values (ksi):				Absolute Dpth to	
		R1	R2	R3	R4	R5	R6	R7	SURF(E1)	BASE(E2)	SUBB(E3)	SUBG(E4)	ERR/Sens	Bedrock
0.000	8,909	11.65	6.60	3.66	2.52	1.68	1.50	1.20	106.7	229.0	0.0	13.1	12.06	91.1
10.000	8,981	12.87	7.11	4.11	2.85	1.91	1.71	1.34	78.5	320.5	0.0	11.5	11.74	95.7
20.000	8,973	11.43	6.98	4.21	3.02	2.01	1.81	1.39	106.0	345.1	0.0	10.4	10.84	91.7
31.000	8,937	13.38	7.53	4.57	3.27	2.11	1.87	1.46	74.3	356.9	0.0	10.0	10.57	84.8
40.000	8,894	10.77	6.59	4.07	2.89	1.89	1.72	1.37	113.6	356.6	0.0	10.8	10.52	87.0
50.000	8,878	11.30	6.29	3.88	2.74	1.84	1.61	1.26	82.4	488.2	0.0	11.5	10.51	96.3
60.000	8,886	11.63	6.51	3.98	2.84	1.89	1.67	1.33	81.2	462.2	0.0	11.2	10.69	92.4
70.000	8,897	11.47	6.45	3.92	2.75	1.84	1.59	1.28	86.1	415.0	0.0	11.6	10.46	94.9
82.000	8,905	10.92	6.15	3.89	2.82	1.91	1.64	1.44	83.9	588.8	0.0	11.0	9.71	98.6
92.000	8,894	10.57	5.81	3.86	2.85	1.93	1.74	1.42	80.3	807.4	0.0	10.5	9.62	98.6
100.000	8,882	9.74	6.03	3.94	2.85	1.91	1.72	1.41	115.3	538.2	0.0	10.4	9.59	94.7
129.000	8,937	12.33	7.18	4.52	3.22	2.13	1.86	1.48	84.2	405.5	0.0	9.8	9.84	92.9
130.000	8,846	12.41	7.33	4.58	3.20	2.06	1.81	1.46	93.6	305.8	0.0	9.9	9.80	85.8
141.000	8,925	11.65	6.98	4.46	3.21	2.05	1.80	1.41	97.7	380.1	0.0	9.9	9.30	82.4
152.000	8,925	12.41	7.06	4.36	3.02	1.99	1.68	1.32	85.6	337.4	0.0	10.7	9.65	92.3
161.000	8,941	11.48	6.82	4.14	2.93	1.90	1.65	1.30	104.4	316.6	0.0	11.0	10.03	84.8
171.000	8,886	12.17	6.80	4.14	2.90	1.90	1.68	1.32	81.1	381.9	0.0	11.1	10.66	89.0
181.000	8,894	12.09	6.78	4.10	2.87	1.87	1.63	1.28	84.3	355.5	0.0	11.3	10.46	87.0
193.000	8,941	12.40	6.80	4.13	2.95	1.93	1.73	1.37	74.3	441.4	0.0	11.0	10.98	87.5
202.000	8,933	14.26	7.56	4.31	3.00	2.00	1.77	1.38	64.7	310.7	0.0	11.0	11.87	94.5
214.000	8,913	13.57	8.05	4.49	3.10	2.01	1.78	1.41	119.3	145.0	0.0	10.6	10.94	85.0
221.000	8,878	13.84	7.82	4.39	3.01	1.99	1.76	1.37	87.9	198.1	0.0	11.0	11.50	91.5
231.000	8,894	14.42	7.85	4.35	3.00	1.97	1.76	1.39	75.7	211.5	0.0	11.2	11.92	89.0
242.000	8,894	13.46	7.79	4.34	2.99	1.98	1.76	1.37	100.1	180.9	0.0	11.0	11.64	91.1
251.000	8,854	14.51	8.32	4.65	3.21	2.08	1.84	1.44	93.2	160.9	0.0	10.3	11.10	85.7
263.000	8,858	13.80	7.91	4.40	3.05	2.00	1.80	1.39	92.8	186.1	0.0	10.8	11.61	88.0
275.000	8,866	14.32	8.30	4.47	3.07	2.02	1.78	1.43	111.5	125.7	0.0	10.7	12.13	88.6
282.000	8,894	14.59	8.37	4.50	3.02	2.00	1.80	1.47	112.4	115.3	0.0	10.8	12.50	91.9
292.000	8,886	14.42	8.36	4.65	3.17	2.06	1.86	1.44	104.5	140.9	0.0	10.4	11.38	86.7
301.000	8,838	14.74	8.59	4.63	3.11	2.05	1.81	1.43	117.3	108.2	0.0	10.4	12.04	90.6
314.000	8,901	13.94	7.91	4.59	3.12	2.05	1.83	1.46	83.9	221.9	0.0	10.5	11.22	91.4
324.000	8,862	12.52	7.24	4.21	2.91	1.91	1.68	1.34	95.7	247.3	0.0	11.2	10.92	89.0
336.000	8,929	12.31	7.37	4.31	3.00	1.97	1.74	1.38	108.6	233.7	0.0	10.8	10.77	88.8
Mean:		12.65	7.25	4.27	2.98	1.96	1.74	1.38	93.4	315.7	0.0	10.8	10.86	90.4
Std. Dev:		1.36	0.75	0.27	0.16	0.09	0.09	0.07	14.7	153.7	0.0	0.6	0.87	4.0
Var Coeff(%):		10.75	10.34	6.29	5.48	4.67	4.97	4.86	15.7	48.7	0.0	5.8	7.97	4.4

SH194 Approach mod.asc

TTI MODULUS ANALYSIS SYSTEM (SUMMARY REPORT)

(Version 6.0)

District:5 (Lubbock)  
 County :96 (HALE)  
 Highway/Road: SH0194

	Thickness(in)	MODULI RANGE(psi)		Poisson Ratio Values	
Pavement:	1.50	Minimum	Maximum	H1: v =	0.38
Base:	3.50	693,200	693,200	H2: v =	0.35
Subbase:	6.00	50,000	1,000,000	H3: v =	0.35
Subgrade:	167.78(by DB)	4,000	200,000	H4: v =	0.40
			15,000		

Station	Load (lbs)	Measured Deflection (mils):							Calculated Moduli values (ksi):				Absolute Dpth to	
		R1	R2	R3	R4	R5	R6	R7	SURF(E1)	BASE(E2)	SUBB(E3)	SUBG(E4)	ERR/Sens	Bedrock
0.000	9,223	29.16	22.08	13.14	8.20	5.16	4.11	3.35	693.2	396.3	19.6	6.6	4.63	163.3
10.000	9,215	34.96	24.54	14.47	8.66	5.33	4.19	3.25	693.2	218.9	15.4	6.2	3.70	151.8
20.000	9,148	34.77	22.19	12.54	7.74	4.73	3.96	3.38	693.2	115.9	21.2	6.9	4.26	140.6
30.000	9,112	31.94	22.85	13.56	8.19	4.97	4.15	3.39	693.2	261.2	17.5	6.5	4.79	139.9
42.000	9,040	34.06	23.54	12.94	7.76	4.92	3.95	3.08	693.2	177.5	15.7	6.6	4.87	173.6
51.000	9,096	33.86	23.60	13.57	8.00	4.91	3.94	3.24	693.2	220.9	13.9	6.6	4.23	148.6
62.000	9,029	40.87	25.54	12.56	7.21	4.50	3.88	3.38	693.2	96.6	10.1	6.9	5.85	160.3
71.000	9,072	39.54	24.33	11.85	6.61	4.17	3.54	2.97	693.2	102.8	9.4	7.5	5.53	136.2
83.000	9,112	31.94	20.22	10.27	6.09	3.90	3.26	2.71	693.2	124.8	17.5	8.3	5.51	174.4
92.000	9,172	28.45	18.03	9.39	5.77	3.78	3.17	2.68	693.2	124.6	26.7	8.9	5.65	196.3
101.000	9,148	27.53	17.88	9.85	6.11	3.96	3.28	2.69	693.2	155.2	28.5	8.6	4.95	183.6
115.000	9,172	22.20	15.27	9.11	6.04	4.06	3.33	2.70	693.2	148.4	74.6	8.7	5.49	232.1
121.000	9,279	21.12	15.14	8.79	5.90	3.98	3.33	2.69	693.2	205.1	72.7	9.0	6.32	235.7
131.000	9,160	19.17	13.44	8.22	5.74	4.00	3.32	2.67	693.2	103.4	164.8	9.0	6.05	300.0
142.000	9,128	21.43	13.56	7.91	5.48	3.79	3.13	2.67	693.2	55.6	162.1	9.5	6.13	288.3
151.000	9,187	20.53	14.07	8.22	5.53	3.71	3.21	2.69	693.2	144.5	87.7	9.5	6.69	222.2
161.000	9,096	20.49	13.95	8.43	5.66	3.72	3.26	2.72	693.2	130.3	97.1	9.2	6.42	191.2
172.000	9,140	22.82	14.91	8.83	6.09	4.05	3.37	2.62	693.2	72.4	111.0	8.7	5.86	208.0
180.000	9,084	24.18	16.37	9.24	5.99	3.89	3.18	2.56	693.2	173.8	42.8	8.8	5.28	181.2
199.000	9,044	31.31	17.82	9.96	6.25	4.08	3.35	2.65	693.2	51.0	41.3	8.3	4.65	193.0
202.000	9,021	31.32	18.61	10.03	6.57	4.11	3.37	2.82	693.2	74.6	30.9	8.1	4.58	148.0
211.000	9,044	27.99	17.27	9.54	6.13	3.95	3.28	2.66	693.2	92.3	37.7	8.5	5.07	174.0
220.000	9,120	20.08	13.81	8.16	5.60	3.77	3.19	2.64	693.2	124.7	106.8	9.4	6.36	227.0
231.000	9,076	22.59	15.38	9.13	6.24	4.12	3.47	2.84	693.2	116.4	84.0	8.4	5.93	199.1
240.000	9,076	26.45	18.50	10.54	6.63	4.50	3.64	2.80	693.2	198.5	34.9	7.7	5.47	272.0
251.000	9,088	30.38	21.51	12.17	7.67	4.81	3.86	3.12	693.2	232.6	20.8	6.9	4.61	157.3
261.000	9,056	34.52	23.84	12.45	6.20	4.01	3.24	2.59	693.2	225.4	5.9	8.0	5.96	88.3
270.000	9,080	23.24	16.02	9.21	5.77	3.64	2.94	2.45	693.2	275.2	32.7	9.2	4.41	154.2
281.000	9,056	25.07	16.98	9.72	5.83	3.50	2.94	2.50	693.2	256.7	24.3	9.0	4.64	126.2
293.000	8,965	30.72	18.97	9.97	6.20	3.95	3.22	2.67	693.2	99.4	24.7	8.2	4.61	166.0
301.000	9,076	21.50	15.02	9.06	5.91	3.83	3.14	2.55	693.2	205.6	62.8	8.9	5.03	177.7
Mean:		27.88	18.56	10.41	6.51	4.19	3.46	2.83	693.2	160.7	48.9	8.1	5.28	178.8
Std. Dev:		6.05	3.84	1.91	0.92	0.49	0.36	0.29	0.0	76.8	43.1	1.0	0.76	47.0
Var Coeff(%):		21.70	20.68	18.37	14.14	11.66	10.44	10.21	0.0	47.8	88.3	12.6	14.43	26.3

SH194 Departure mod.asc

TTI MODULUS ANALYSIS SYSTEM (SUMMARY REPORT)

(Version 6.0)

District:5 (Lubbock)  
 County :96 (HALE)  
 Highway/Road: SH0194

	Thickness(in)	MODULI RANGE(psi)		Poisson Ratio Values
		Minimum	Maximum	
Pavement:	1.50	606,600	606,600	H1: v = 0.38
Base:	3.50	50,000	1,000,000	H2: v = 0.35
Subbase:	6.00	4,000	200,000	H3: v = 0.35
Subgrade:	123.58(by DB)		15,000	H4: v = 0.40

Station	Load (lbs)	Measured Deflection (mils):							Calculated Moduli values (ksi):				Absolute Dpth to Bedrock	
		R1	R2	R3	R4	R5	R6	R7	SURF(E1)	BASE(E2)	SUBB(E3)	SUBG(E4)	ERR/Sens	Bedrock
0.000	8,703	51.02	30.96	13.81	7.28	4.51	3.89	3.48	606.6	63.1	7.0	5.6	7.81	108.7
10.000	8,834	49.92	29.24	13.32	7.24	4.62	3.81	3.32	606.6	55.4	9.2	5.7	7.46	122.7
21.000	8,766	49.59	27.09	11.70	6.01	3.70	3.25	2.89	606.6	51.8	7.2	6.6	7.15	95.9
33.000	8,850	42.51	24.48	11.40	6.63	4.09	3.47	2.97	606.6	55.3	14.7	6.5	6.91	147.6
43.000	8,826	40.81	23.89	11.87	6.98	4.30	3.61	3.00	606.6	56.9	18.6	6.2	6.48	147.6
52.000	8,691	45.68	22.35	10.15	5.72	3.66	3.12	2.65	606.6	50.0	9.8	7.3	8.70	141.4 *
64.000	8,953	33.15	20.02	9.88	5.50	3.59	2.87	2.37	606.6	89.9	20.3	7.7	7.08	130.2
74.000	8,909	33.65	20.64	9.65	5.48	3.44	3.02	2.64	606.6	94.8	17.3	7.8	8.12	146.3
82.000	8,830	37.31	21.87	10.78	6.26	4.05	3.50	3.13	606.6	63.8	20.4	6.8	7.78	176.6
103.000	8,735	43.60	25.40	11.22	5.85	3.81	3.15	2.75	606.6	68.3	8.9	6.8	8.14	100.1
112.000	8,878	31.76	20.71	10.50	6.03	3.62	3.18	2.79	606.6	132.0	19.7	7.3	7.82	129.6
121.000	8,909	31.69	21.41	10.98	6.60	4.17	3.59	3.06	606.6	163.4	20.3	6.8	7.79	163.6
131.000	8,822	38.41	24.79	11.92	7.20	4.61	3.98	3.36	606.6	84.4	18.1	6.0	8.66	181.0
142.000	8,854	34.15	21.96	11.12	6.47	4.08	3.46	2.90	606.6	107.9	20.1	6.7	7.38	164.4
151.000	8,985	33.96	24.54	12.02	6.78	4.06	3.24	2.70	606.6	229.7	9.7	6.6	7.56	132.2
160.000	8,921	35.50	22.77	9.81	5.52	3.27	2.62	2.30	606.6	131.9	8.7	8.0	7.35	133.9
171.000	8,973	27.94	17.94	9.61	5.67	3.59	2.90	2.31	606.6	140.9	29.4	7.9	6.22	161.6
180.000	8,933	30.08	18.77	9.66	5.69	3.35	2.86	2.50	606.6	118.8	23.7	7.9	6.62	118.5
191.000	8,770	34.27	25.04	11.09	6.02	3.64	2.96	2.48	606.6	202.7	6.9	7.1	9.16	117.4
201.000	8,921	31.09	18.76	9.03	5.00	3.13	2.60	2.21	606.6	106.0	18.5	8.5	6.86	124.6
211.000	8,909	32.54	18.59	8.43	4.85	3.25	2.53	2.23	606.6	77.1	19.1	8.7	8.39	155.9
221.000	8,866	30.88	21.58	8.61	5.19	3.43	2.93	2.47	606.6	158.4	12.2	8.3	12.84	82.0
231.000	9,005	24.02	17.28	9.17	5.00	3.47	2.93	2.50	606.6	320.0	25.4	8.5	9.40	115.5
242.000	8,913	26.47	16.62	8.89	5.35	3.39	2.87	2.42	606.6	113.4	37.9	8.3	7.15	159.2
251.000	8,945	27.04	17.44	8.98	5.39	3.54	2.98	2.49	606.6	135.6	31.5	8.2	8.34	200.7
261.000	8,822	31.21	19.99	10.00	5.59	3.72	3.02	2.47	606.6	116.5	21.4	7.5	7.99	133.9
271.000	8,838	36.74	24.62	11.97	6.71	6.27	4.54	3.44	606.6	75.0	26.7	5.8	15.92	141.5
282.000	8,655	52.42	27.89	12.65	6.86	4.24	3.83	3.39	606.6	50.0	7.5	6.0	7.53	120.5 *
291.000	8,842	39.66	26.20	14.23	7.85	4.69	3.59	2.79	606.6	127.3	13.1	5.6	5.02	134.7
301.000	8,683	49.11	28.34	13.79	7.37	4.17	3.33	2.77	606.6	60.2	8.6	5.7	4.85	115.0
Mean:		36.87	22.71	10.87	6.14	3.92	3.25	2.76	606.6	110.0	17.1	7.1	7.95	134.6
Std. Dev:		7.93	3.81	1.62	0.81	0.63	0.46	0.38	0.0	60.7	8.1	1.0	2.06	27.0
Var Coeff(%):		21.50	16.79	14.92	13.27	15.99	14.18	13.74	0.0	55.2	47.3	14.0	25.94	20.0

FM1318 Approach.asc

TTI MODULUS ANALYSIS SYSTEM (SUMMARY REPORT)

(Version 6.0)

District:5 (Lubbock)  
 County :219 (SWISHER)  
 Highway/Road: FM1318

	Thickness(in)	Minimum	Maximum	Poisson Ratio Values
Pavement:	1.50	315,000	315,000	H1: v = 0.38
Base:	6.00	10,000	150,000	H2: v = 0.35
Subbase:	0.00			H3: v = 0.00
Subgrade:	89.33(by DB)		15,000	H4: v = 0.40

Station	Load (lbs)	Measured Deflection (mils):							Calculated Moduli values (ksi):				Absolute Dpth to	
		R1	R2	R3	R4	R5	R6	R7	SURF(E1)	BASE(E2)	SUBB(E3)	SUBG(E4)	ERR/Sens	Bedrock
0.000	8,770	43.88	16.52	6.39	4.23	3.00	2.69	2.39	315.0	25.4	0.0	9.3	23.17	71.0
11.000	8,814	59.83	20.78	7.52	4.84	3.27	3.14	2.69	315.0	14.6	0.0	7.8	21.87	60.9
21.000	8,707	69.93	22.89	8.70	5.70	3.89	3.48	2.91	315.0	11.4	0.0	6.9	23.38	68.6
31.000	8,754	45.35	18.08	8.13	5.67	4.08	3.50	2.81	315.0	30.8	0.0	7.8	26.49	185.3
43.000	8,802	52.28	21.46	9.09	6.00	4.18	3.88	3.13	315.0	25.1	0.0	6.9	23.89	112.5
53.000	8,818	49.36	22.01	8.71	5.88	4.16	3.72	3.08	315.0	29.1	0.0	6.9	23.30	78.1
60.000	8,766	66.35	25.00	9.65	6.13	4.30	3.73	2.93	315.0	15.4	0.0	6.2	21.94	72.8
71.000	8,878	42.06	17.07	7.69	5.39	3.80	3.35	2.76	315.0	35.4	0.0	8.4	26.40	186.9
83.000	8,874	45.74	17.98	7.59	5.04	3.47	3.02	2.47	315.0	27.2	0.0	8.3	23.49	107.8
93.000	8,715	52.59	20.71	7.46	4.83	3.38	3.11	2.58	315.0	20.1	0.0	7.7	21.43	60.4
105.000	8,778	65.22	22.79	8.18	4.88	3.06	2.92	2.64	315.0	12.6	0.0	7.3	17.97	60.8
113.000	8,723	66.51	23.94	7.89	4.72	3.37	2.94	2.41	315.0	11.9	0.0	7.1	18.56	55.4
122.000	8,766	72.04	26.05	8.15	4.83	3.21	3.13	2.71	315.0	10.3	0.0	6.8	17.50	54.8
131.000	8,782	73.23	30.87	9.30	5.08	3.61	3.06	2.67	315.0	11.6	0.0	6.0	17.87	56.0
141.000	8,727	71.81	29.04	8.43	4.80	3.33	2.91	2.42	315.0	11.0	0.0	6.4	17.89	56.4
152.000	8,822	58.42	25.29	8.65	5.00	3.37	3.00	2.52	315.0	18.5	0.0	6.7	16.70	57.5
161.000	8,917	30.37	16.17	7.84	5.09	3.44	2.96	2.51	315.0	98.6	0.0	8.1	20.65	300.0
174.000	8,774	53.16	22.60	9.20	5.56	3.66	3.52	2.89	315.0	23.8	0.0	6.8	19.61	90.6
181.000	8,854	51.26	22.17	9.50	5.71	3.83	3.39	2.80	315.0	27.5	0.0	6.8	19.84	125.7
192.000	8,806	52.60	22.20	9.32	5.80	3.89	3.28	2.77	315.0	25.1	0.0	6.8	20.53	107.6
201.000	8,747	47.15	19.46	8.28	5.33	3.72	3.31	2.81	315.0	28.2	0.0	7.6	22.91	115.6
213.000	8,747	73.94	29.82	11.15	6.50	4.60	3.73	2.89	315.0	13.8	0.0	5.3	18.03	68.1
220.000	8,794	57.02	25.67	9.91	6.12	4.03	3.44	2.84	315.0	22.8	0.0	6.1	18.52	73.2
230.000	8,917	32.46	16.19	8.69	5.82	3.95	3.38	2.75	315.0	101.3	0.0	7.4	23.09	250.7
241.000	8,814	46.13	19.88	9.75	6.48	4.22	3.77	3.16	315.0	39.5	0.0	6.7	24.12	300.0
250.000	8,790	50.07	22.08	10.76	7.01	4.87	4.10	3.26	315.0	37.4	0.0	6.0	23.84	300.0
261.000	8,862	36.33	18.64	9.61	6.41	4.30	3.65	2.97	315.0	84.9	0.0	6.6	21.82	232.0
271.000	9,005	31.27	18.16	9.90	6.51	4.25	3.45	2.70	315.0	147.1	0.0	6.4	18.06	189.6
281.000	8,953	35.02	17.66	9.41	6.19	4.05	3.18	2.58	315.0	89.8	0.0	6.9	21.03	190.8
293.000	8,627	54.03	23.77	10.50	6.54	4.29	3.58	2.92	315.0	27.4	0.0	6.0	20.45	167.4
304.000	8,790	46.27	20.46	9.90	6.65	4.44	3.69	3.00	315.0	41.1	0.0	6.5	23.94	300.0
Mean:		52.63	21.79	8.88	5.64	3.84	3.36	2.77	315.0	36.1	0.0	7.0	21.24	96.8
Std. Dev:		12.81	3.92	1.08	0.71	0.47	0.34	0.23	0.0	32.9	0.0	0.8	2.69	48.1
Var Coeff(%):		24.34	18.01	12.17	12.61	12.27	10.07	8.19	0.0	91.1	0.0	12.0	12.69	50.6



FM1318 Departure.asc

TTI MODULUS ANALYSIS SYSTEM (SUMMARY REPORT)

(Version 6.0)

District:5 (Lubbock)  
 County :219 (SWISHER)  
 Highway/Road: FM1318

	Thickness(in)	MODULI RANGE(psi)	Poisson Ratio Values
Pavement:	1.50	Minimum 267,000	Maximum 267,000
Base:	6.00	10,000	150,000
Subbase:	0.00		
Subgrade:	189.30(by DB)	15,000	

Station	Load (lbs)	Measured Deflection (mils):							Calculated Moduli values (ksi):				Absolute Dpth to	
		R1	R2	R3	R4	R5	R6	R7	SURF(E1)	BASE(E2)	SUBB(E3)	SUBG(E4)	ERR/Sens	Bedrock
0.000	8,870	40.61	20.34	9.04	5.56	3.55	3.11	2.59	267.0	37.2	0.0	9.2	6.00	172.8
12.000	9,013	23.03	11.63	6.33	4.66	3.43	3.11	2.62	267.0	122.5	0.0	13.2	17.27	300.0
23.000	9,100	23.77	13.28	7.85	5.61	4.06	3.48	2.79	267.0	150.0	0.0	11.0	15.16	300.0 *
32.000	9,084	22.26	12.14	7.08	5.09	3.68	3.21	2.59	267.0	150.0	0.0	12.3	15.77	300.0 *
43.000	8,949	31.32	15.38	7.75	5.33	3.78	3.31	2.79	267.0	64.8	0.0	10.8	12.85	300.0
52.000	8,957	34.63	17.18	7.85	5.07	3.53	3.13	2.59	267.0	48.7	0.0	10.5	8.52	227.7
60.000	8,965	28.74	15.31	7.80	5.25	3.79	3.37	2.67	267.0	85.5	0.0	10.7	12.05	300.0
70.000	8,909	35.09	17.62	8.57	5.55	3.70	3.30	2.83	267.0	52.5	0.0	9.8	8.58	217.2
82.000	8,941	36.25	19.93	10.27	6.34	4.07	3.44	2.63	267.0	61.8	0.0	8.5	5.25	175.3
92.000	8,854	41.26	23.46	11.27	6.67	4.19	3.62	2.89	267.0	48.0	0.0	7.6	6.10	160.5
101.000	8,937	39.80	21.62	9.41	5.64	3.88	3.47	2.93	267.0	42.8	0.0	8.8	8.29	142.9
110.000	8,894	42.55	23.45	10.85	5.98	4.27	3.56	2.88	267.0	41.3	0.0	7.9	7.25	125.7
121.000	8,933	39.60	22.10	9.03	5.16	3.48	3.00	2.51	267.0	39.9	0.0	9.1	9.22	92.8
133.000	9,033	30.34	14.90	6.72	4.27	2.95	2.57	2.26	267.0	54.6	0.0	12.5	7.45	190.5
143.000	9,064	24.02	13.32	6.59	4.33	2.93	2.70	2.31	267.0	105.3	0.0	13.0	9.13	232.3
155.000	8,977	23.61	13.69	7.75	5.17	3.41	2.87	2.37	267.0	150.0	0.0	11.1	9.34	194.2 *
167.000	9,052	20.91	13.22	7.88	5.26	3.36	2.92	2.45	267.0	150.0	0.0	11.8	11.53	158.6 *
174.000	8,969	32.07	18.43	9.33	5.54	3.45	2.94	2.49	267.0	72.1	0.0	9.5	4.92	147.1
181.000	8,997	30.73	17.72	8.53	5.16	3.51	2.85	2.34	267.0	74.0	0.0	10.1	6.20	242.4
190.000	9,029	32.49	17.04	7.48	4.41	2.90	2.52	2.13	267.0	51.2	0.0	11.4	6.96	149.2
200.000	8,993	29.10	13.42	6.10	3.70	2.44	2.19	1.89	267.0	50.2	0.0	14.0	5.26	207.9
211.000	9,076	16.19	9.32	5.16	3.60	2.42	2.12	1.78	267.0	150.0	0.0	18.6	14.54	209.7 *
222.000	9,096	20.01	10.17	5.22	3.43	2.44	2.14	1.88	267.0	117.2	0.0	16.9	10.95	300.0
232.000	8,913	36.55	17.27	6.72	4.03	2.68	2.38	2.15	267.0	33.4	0.0	11.7	8.74	73.2
243.000	9,060	24.19	13.22	6.71	4.56	3.14	2.83	2.43	267.0	110.0	0.0	12.7	11.10	300.0
251.000	9,033	22.90	15.08	8.52	5.80	3.63	2.99	2.34	267.0	150.0	0.0	10.5	9.12	143.4 *
263.000	9,009	30.63	17.97	9.87	6.18	3.95	3.38	2.87	267.0	98.0	0.0	8.9	5.82	168.3
271.000	8,854	37.55	20.00	8.36	4.77	3.13	2.69	2.22	267.0	40.1	0.0	9.9	8.30	104.9
281.000	8,977	29.09	15.59	7.07	4.41	3.07	2.66	2.19	267.0	65.9	0.0	11.9	7.89	205.8
292.000	9,048	26.14	14.99	7.38	4.39	2.86	2.48	2.04	267.0	90.6	0.0	12.0	5.52	182.4
301.000	8,997	26.50	15.13	7.68	4.68	3.08	2.70	2.35	267.0	94.6	0.0	11.4	5.61	196.1
Mean:		30.06	16.26	7.94	5.02	3.38	2.94	2.45	267.0	83.9	0.0	11.2	9.05	196.8
Std. Dev:		7.06	3.68	1.48	0.80	0.52	0.43	0.32	0.0	41.0	0.0	2.4	3.36	78.2
Var Coeff(%):		23.49	22.66	18.69	15.92	15.29	14.56	12.93	0.0	48.8	0.0	21.2	37.07	40.7

**APPENDIX H**  
**MAXIMUM AND MINIMUM STRAINS FROM LOAD TESTING**

APPENDIX TABLE 16. MAXIMUM AND MINIMUM STRAIN ( $\mu\epsilon$ ) FROM LIVE LOAD TEST ON SHALLOWATER CULVERT UNDER 2' OF FILL.

		M1 - IWBE C	M1 - IWEM	M1 - IWTE C	M1 - EWTE C	M2 - ITE C	M2 - ETE C	M2 - ITE M	M2 - ETE M O	M2 - ITIC1	M2 - ETIC1
<i>One Truck</i>	max	0.000	-1.896	-4.739	37.465	0.000	36.627	22.290	2.847	-13.281	781.525
<i>Gage Line Beneath Wheel</i>	min	-4.737	-10.425	-90.980	-1.423	-70.399	-0.951	-2.845	-27.047	-105.766	246.089
<i>One Truck</i>	max	1.421	2.369	1.896	42.682	4.281	39.957	28.455	3.322	-4.269	563.280
<i>Straddling Gage Line</i>	min	-4.737	-10.425	-94.297	-2.371	-74.204	-3.805	-3.320	-39.383	-100.075	3.807
<i>Two Trucks</i>	max	-1.421	-4.265	-7.582	59.281	0.000	55.655	36.518	1.898	-21.345	6402.179
<i>Straddling Gage Line</i>	min	-11.370	-21.798	-136.464	-2.845	-103.692	-4.281	-7.114	-55.041	-147.971	410.375
		M3 - IWBI C1	M3 - IWBI C2	M3 - IWIM1	M3 - IWIM2	M3 - IWTIC1	M3 - IWTIC2	M4 - IBEC	M4 - IBEM	M4 - IBIC1	M5 - ITIC2
<i>One Truck</i>	max	13.754	5.203	0.000	-0.949	28.112	27.458	-0.947	-1.890	-2.368	-1.422
<i>Gage Line Beneath Wheel</i>	min	-20.394	-10.878	-9.463	-9.014	-70.989	-67.218	-7.575	-5.671	-6.629	-41.248
<i>One Truck</i>	max	16.600	8.040	0.000	0.949	39.548	37.874	3.314	2.363	0.000	0.948
<i>Straddling Gage Line</i>	min	-21.816	-12.770	-9.936	-10.437	-61.937	-62.485	-6.628	-4.253	-6.156	-39.351
<i>Two Trucks</i>	max	22.292	8.040	-0.473	-1.423	51.938	44.502	-2.367	-0.945	-2.841	-2.371
<i>Straddling Gage Line</i>	min	-38.415	-23.175	-18.452	-18.028	-91.474	-96.091	-16.097	-9.924	-11.838	-59.737
		M5 - ETIC2	M5 - ITIM	M5 - ETIM	M5 - ITIC3	M5 - ETIC3	M6 - IWBI C3	M6 - IWBI C4	M6 - IWIM3	M6 - IWIM4	M6 - IWTIC3
<i>One Truck</i>	max	29.888	40.230	3.785	-3.776	40.755	4.731	5.222	-1.421	-0.473	26.459
<i>Gage Line Beneath Wheel</i>	min	-1.898	-11.358	-32.647	-38.230	-1.422	-12.773	-9.494	-8.999	-11.341	-43.938
<i>One Truck</i>	max	29.414	52.063	3.785	2.360	42.177	5.677	4.272	0.947	1.890	30.712
<i>Straddling Gage Line</i>	min	-2.372	-10.885	-42.582	-39.646	-5.213	-11.354	-10.918	-8.999	-10.869	-42.048
<i>Two Trucks</i>	max	41.749	66.262	3.785	-6.136	58.764	5.677	8.545	-2.368	-3.308	41.107
<i>Straddling Gage Line</i>	min	-3.321	-21.297	-60.560	-60.883	-5.687	-18.923	-16.140	-16.577	-18.902	-64.725
		M6 - IWTIC4	M7 - IBIC2	M7 - IBIM	M7 - IBIC3						
<i>One Truck</i>	max	26.981	-3.784	-3.318	-1.897						
<i>Gage Line Beneath Wheel</i>	min	-38.812	-12.770	-7.583	-12.804						
<i>One Truck</i>	max	30.768	0.000	1.896	0.948						
<i>Straddling Gage Line</i>	min	-33.132	-12.297	-6.162	-11.855						
<i>Two Trucks</i>	max	40.235	-6.622	-5.214	-3.320						
<i>Straddling Gage Line</i>	min	-48.751	-26.486	-16.115	-23.236						

APPENDIX TABLE 17. MAXIMUM AND MINIMUM STRAIN ( $\mu\epsilon$ ) FROM LIVE LOAD TEST ON SHALLOWATER CULVERT UNDER 4' OF FILL.

		M1 - IWBE C	M1 - IWEM	M1 - IWTE C	M1 - EWTE C	M2 - ITE C	M2 - ETE C	M2 - ITE M	M2 - ETE M O	M2 - ITIC1	M2 - ETIC1
<i>One Truck</i>	max	2.369	2.369	0.000	20.393	0.476	20.931	12.805	1.898	-1.423	555.181
<i>Gage Line Beneath Wheel</i>	min	-4.737	-6.634	-47.388	0.000	-29.964	0.476	-0.474	-14.234	-43.153	0.000
<i>One Truck</i>	max	2.842	6.160	6.633	25.135	4.281	23.785	16.599	3.321	6.165	0.000
<i>Straddling Gage Line</i>	min	-3.316	-6.160	-45.484	-0.948	-32.818	-0.951	-0.948	-18.504	-40.307	0.000
<i>Two Trucks</i>	max	3.316	4.738	-1.421	36.518	0.476	34.250	23.239	4.270	-4.742	0.000
<i>Straddling Gage Line</i>	min	-4.737	-7.581	-66.329	0.948	-45.184	1.903	0.474	-25.147	-68.758	0.000
		M3 - IWBI C1	M3 - IWBI C2	M3 - IWIM1	M3 - IWIM2	M3 - IWTI C1	M3 - IWTI C2	M4 - IBEC	M4 - IBEM	M4 - IBIC1	M5 - ITIC2
<i>One Truck</i>	max	8.537	5.202	1.419	2.372	12.864	11.835	3.788	2.836	0.000	0.000
<i>Gage Line Beneath Wheel</i>	min	-11.382	-5.202	-4.258	-6.167	-42.402	-36.449	-7.575	-4.253	-3.788	-23.229
<i>One Truck</i>	max	13.280	6.621	3.785	2.846	21.917	17.989	6.155	4.726	1.421	4.741
<i>Straddling Gage Line</i>	min	-10.908	-7.094	-5.677	-4.744	-37.162	-36.449	-2.841	-0.473	-3.315	-22.755
<i>Two Trucks</i>	max	16.125	9.459	3.312	1.423	30.494	21.776	5.681	4.253	0.000	-1.422
<i>Straddling Gage Line</i>	min	-20.867	-8.040	-7.097	-8.065	-49.072	-54.909	-3.314	-2.363	-7.103	-34.607
		M5 - ETIC2	M5 - ITIM	M5 - ETIM	M5 - ITIC3	M5 - ETIC3	M6 - IWBI C3	M6 - IWBI C4	M6 - IWIM3	M6 - IWIM4	M6 - IWTI C3
<i>One Truck</i>	max	17.554	27.925	3.785	0.472	27.014	4.731	5.222	1.421	3.780	14.647
<i>Gage Line Beneath Wheel</i>	min	0.000	-5.679	-16.086	-22.181	0.000	-5.204	-3.323	-4.736	-5.670	-24.568
<i>One Truck</i>	max	17.554	34.551	6.624	3.776	27.962	6.150	6.171	3.315	6.615	18.899
<i>Straddling Gage Line</i>	min	-2.372	-1.893	-19.870	-22.181	-2.843	-3.311	-3.798	-4.736	-3.780	-25.040
<i>Two Trucks</i>	max	32.263	52.537	4.731	-1.416	200.506	7.096	11.867	3.789	6.143	27.876
<i>Straddling Gage Line</i>	min	2.372	-0.947	-29.332	-47.664	2.370	-8.515	-2.373	-4.736	-4.253	-29.764
		M6 - IWTI C4	M7 - IBIC2	M7 - IBIM	M7 - IBIC3						
<i>One Truck</i>	max	15.620	1.892	4.266	1.423						
<i>Gage Line Beneath Wheel</i>	min	-18.459	-5.676	-7.109	-6.639						
<i>One Truck</i>	max	18.460	4.730	4.740	3.319						
<i>Straddling Gage Line</i>	min	-17.986	-5.676	0.000	-5.216						
<i>Two Trucks</i>	max	21.773	4.730	7.110	3.319						
<i>Straddling Gage Line</i>	min	-30.292	-8.986	-0.474	-10.432						

APPENDIX TABLE 18. STRAIN ( $\mu\epsilon$ ) FROM DEAD LOAD TEST ON SHALLOWATER CULVERT DO TO A CHANGE IN FILL DEPTH FROM 2' TO 4'.

	M1 - IWBE C	M1 - IWEM	M1 - IWTE C	M1 - EWTE C	M2 - ITE C	M2 - ETE C	M2 - ITEM	M2 - ETEM O	M2 - ITIC1	M2 - ETIC1	M3 - IWBE C1	
<i>Dead Load</i>												
<i>Strain</i>	-14.685	-27.010	-77.711	18.969	-54.702	20.930	6.165	-34.638	-93.431	0.000	-18.971	
<i>Difference</i>												
	M3 - IWBE C2	M3 - IWIM1	M3 - IWIM2	M3 - IWTIC1	M3 - IWTIC2	M4 - IBEC	M4 - IBEM	M4 - IBIC1	M5 - ITIC2	M5 - ETIC2	M5 - ITIM	
<i>Dead Load</i>												
<i>Strain</i>	-17.026	-15.613	-13.284	-10.482	-22.723	-4.261	3.308	-8.997	-45.988	32.261	19.404	
<i>Difference</i>												
	M5 - ETIM	M5 - ITIC3	M5 - ETIC3	M6 - IWBE C3	M6 - IWBE C4	M6 - IWIM3	M6 - IWIM4	M6 - IWTIC3	M6 - IWTIC4	M7 - IBIC2	M7 - IBIM	M7 - IBIC3
<i>Dead Load</i>												
<i>Strain</i>	-39.270	-46.252	37.438	-14.192	-12.342	-10.893	-21.264	-5.670	-11.833	-19.392	4.266	-14.700
<i>Difference</i>												

APPENDIX TABLE 19. MAXIMUM AND MINIMUM STRAIN ( $\mu\epsilon$ ) FROM LIVE LOAD TEST ON PLAINVIEW CULVERT UNDER 3.5' OF FILL.

		M1 - IWBE C	M1 - IWEM	M1 - IWTE C	M2 - ITE C	M2 - ITEM	M2 - ITIC1	M2 - ETIC1	M3 - IWBI C1	M3 - IWBI C2	M3 - IWIM1
<i>One Truck</i>	max	2.851	4.742	0.947	8.593	77.860	1.425	0.000	10.899	7.099	2.365
<i>Gage Line Beneath Wheel</i>	min	-4.751	-0.948	-94.659	-1.432	-5.697	-22.328	0.000	-1.895	-2.840	-4.256
<i>One Truck</i>	max	1.425	2.371	-0.473	7.161	84.507	0.475	0.000	8.055	4.733	0.000
<i>Straddling Gage Line</i>	min	-6.651	-4.742	-97.025	-2.864	-6.646	-23.278	0.000	-8.529	-6.152	-7.094
<i>Two Trucks</i>	max	1.900	4.268	2.367	7.638	128.191	0.950	0.000	8.529	5.679	1.419
<i>Straddling Gage Line</i>	min	-11.402	-6.639	-127.312	-5.251	-10.918	-30.879	0.000	-14.689	-9.938	-10.404
		M3 - IWIM2	M3 - IW TIC1	M3 - IW TIC2	M4 - IBEC	M4 - IBEM	M4 - IBIC1	M5 - ITIC2	M5 - ITIM	M5 - ITIC3	M6 - IWBI C3
<i>One Truck</i>	max	3.800	16.100	10.424	9.485	4.270	-3.795	0.945	26.482	3.791	5.709
<i>Gage Line Beneath Wheel</i>	min	-1.900	-24.623	-10.897	5.691	0.000	-13.283	-16.058	6.148	-10.426	-5.709
<i>One Truck</i>	max	2.375	18.941	9.476	4.268	3.321	-0.474	0.472	26.482	4.265	2.379
<i>Straddling Gage Line</i>	min	-4.275	-22.729	-13.266	-1.423	-1.423	-12.808	-17.475	-1.892	-12.322	-9.039
<i>Two Trucks</i>	max	2.375	26.992	12.319	5.691	4.744	-0.474	-0.472	27.901	2.844	7.136
<i>Straddling Gage Line</i>	min	-7.600	-32.672	-22.268	-6.165	-1.898	-17.078	-22.198	-6.148	-18.956	-13.796
		M6 - IWBI C4	M6 - IWIM3	M6 - IWIM4	M6 - IW TIC3	M6 - IW TIC4	M7 - IBIC2	M7 - IBIM	M7 - IBIC3		
<i>One Truck</i>	max	-2019.493	3.320	9.004	33.152	23.649	-0.474	4.265	5.252		
<i>Gage Line Beneath Wheel</i>	min	-2044.761	-3.320	0.948	-43.095	-27.431	-11.379	1.422	-6.207		
<i>One Truck</i>	max	-14.095	4.269	8.056	38.836	23.649	-0.948	2.843	4.774		
<i>Straddling Gage Line</i>	min	-2032.595	-4.269	-0.948	-42.621	-29.323	-15.646	-1.422	-9.548		
<i>Two Trucks</i>	max	-23.022	3.795	8.530	55.887	29.325	-0.474	4.739	4.774		
<i>Straddling Gage Line</i>	min	-2030.723	-9.487	-9.004	-56.827	-43.984	-19.439	-2.370	-18.142		

APPENDIX TABLE 20. MAXIMUM AND MINIMUM STRAIN ( $\mu\epsilon$ ) FROM LIVE LOAD TEST ON TULIA CULVERT UNDER 1.5' OF FILL.

		M1 - IWBE	M1 - IWEM	M1 - IWTEC	M1 - EWTEC	M2 - ITEC	M2 - ETEC	M2 - ITEM	M2 - ETEM	M2 - ITIC1	M2 - ETIC1
<i>One Truck</i>	max	3.337	0.475	13.760	30.372	10.898	35.146	47.071	98.382	1.896	278.825
<i>Gage Line Beneath Wheel</i>	min	-10.963	-9.502	-235.761	-87.782	-7.581	-60.787	-7.607	4.277	-30.339	-98.931
<i>One Truck</i>	max	4.767	0.000	12.811	30.846	5.212	9.974	45.645	69.388	2.844	30.920
<i>Straddling Gage Line</i>	min	-10.963	-9.502	-203.511	-6.169	-6.634	-71.709	-8.082	-15.682	-21.332	-139.830
<i>Two Trucks</i>	max	4.290	-1.900	35.587	26.575	11.372	-9.024	49.924	99.333	1.422	196.018
<i>Straddling Gage Line</i>	min	-23.832	-15.202	-256.154	-91.578	-8.055	-160.974	-10.460	-41.343	-26.072	-106.065
		M3 - IWBC1	M3 - IWBC2	M3 - IWTIC1	M3 - IWTIC2	M10 - IBIC4	M10 - IBIM2	M4 - IBEC	M4 - IBEM	M4 - IBIC1	M8 - ITIC4
<i>One Truck</i>	max	4.264	8.082	31.380	4.731	3.318	0.000	3.832	6.630	-0.474	8.978
<i>Gage Line Beneath Wheel</i>	min	-16.580	-5.705	-59.426	-19.398	-9.005	-1.892	-8.143	-1.421	-16.101	-22.209
<i>One Truck</i>	max	3.790	9.984	46.595	5.678	3.318	0.946	6.227	7.577	0.000	3.308
<i>Straddling Gage Line</i>	min	-19.422	-5.229	-43.738	-16.087	-9.479	-1.419	-8.143	-2.368	-17.522	-18.429
<i>Two Trucks</i>	max	9.948	15.213	67.992	6.151	5.213	0.946	4.790	13.260	-0.947	8.033
<i>Straddling Gage Line</i>	min	-28.896	-8.557	-58.951	-25.549	-16.114	-2.365	-18.680	-2.368	-29.361	-19.374
		M5 - ITIM	M5 - ITIC3	M6 - IWBC3	M6 - IWBC4	M8 - ITIM2	M6 - IWTIC3	M6 - IWTIC4	M7 - IBIC2	M7 - IBIM	M7 - IBIC3
<i>One Truck</i>	max	39.817	1.421	4.259	4.262	52.880	2.846	9.945	1.897	-1.896	0.949
<i>Gage Line Beneath Wheel</i>	min	-8.532	-30.305	-5.679	-7.104	-8.498	-20.396	-24.150	-15.177	-7.109	-5.222
<i>One Truck</i>	max	35.551	2.368	5.679	6.630	38.243	3.320	9.471	3.794	-0.948	1.424
<i>Straddling Gage Line</i>	min	-9.006	-20.835	-5.679	-7.577	-9.442	-17.075	-22.256	-14.703	-6.161	-6.171
<i>Two Trucks</i>	max	44.083	2.841	10.885	8.998	51.464	3.320	8.998	4.743	-1.422	3.798
<i>Straddling Gage Line</i>	min	-13.746	-26.044	-8.992	-9.472	-14.636	-23.716	-34.094	-26.560	-9.953	-8.070

